



2019 CATALOG



CFS BRANDS®



Get to know CFS Brands

Combining the leading names in foodservice, healthcare and sanitary maintenance, San Jamar joins Carlisle FoodService Products, Dinex, Sparta Brush, Snap Drape, Marko and others to offer expanded product choice, services and leadership to the marketplace.

Learn more about CFS Brands at www.cfsbrands.com.

5 CATEGORIES

COUNTER SERVICE



WASHROOM & HYGIENE SOLUTIONS



BAR & FOOD MANAGEMENT



FOOD SAFETY TOOLS



PERSONAL SAFETY



CONTENTS

8 WASHROOM & HYGIENE SOLUTIONS

- 12 Towel Dispensers**
 - No-Touch Roll Towel
 - Touch Roll Towel
 - Folded Towel
- 24 Tissue Dispensers**
 - Standard Bath Tissue
 - Jumbo Bath Tissue
- 30 Soap & Other Dispensers**
 - Soap Dispensers
 - Other Dispensers
- 34 Air Care**

38 COUNTER SERVICE

- 40 Napkin Dispensers**
 - Counter/Wall Mount Napkin
 - In-Counter Napkin
 - Tabletop Napkin
- 46 Cup, Lid & Straw Dispensers**
 - Cup & Lid Systems
 - In-Counter Cup
 - Surface-Mount Cup
 - Lid & Straw
- 62 Countertop Organizers**
- 68 Trays**

70 FOOD SAFETY TOOLS

- 72 Allergen Safety**
- 78 Safe Ice Handling**
 - Totes
 - Scoops & Holders
- 84 Safe Food Preparation**
 - Cold Paddles
 - Cold Serve
 - Safe Prep
- 90 Sanitation Tools**
 - Pails
 - Tools
- 96 Cutting Boards**
 - Grip Boards
 - Standard Boards
 - Specialty & Custom Boards
 - Accessories



104

BAR AND FOOD MANAGEMENT

106 Bar Management

Bar Tools
Garnish Centers
Shelf Matting

114 Food Management

Food Storage
Food Tools
Condiment Centers
Pump Centers
Dessert

128 Kitchen Management

Check Management
Flatware Management
Food Carriers
Floor Matting

134 Measurement Tools

Scales
Scale Accessories
Thermometers
Timers

148

PERSONAL SAFETY

150 Temperature Protection Mitts

High Performance
Value Added
Economy

156 Temperature Protection Gloves & Sleeves

Hot Oil Gloves
Temperature Gloves
Temperature Sleeves

160 Temperature Protection Holders

Pot Holders
Pan Grabbers
Handle Holders

166 Cut Protection

Safety Aids
Cut Protection Gloves

172 Chemical Protection

Aprons
Gloves
Protective Apparel

180 Item Number Index

183 Appendix A, B, C

ICON KEY



Food Safe



Dishwasher Safe



Product meets NSF certification standards



Product does not contain the chemical Bisphenol A



Compliant with health, safety, and environmental protection standards for products sold within the European Economic Area

PRODUCT SWATCH KEY



Black



Black Stainless
Look



Blue
(Cutting Board)



Blue
(Kleen-Pail)



Blue
(Thermometer)



Brown



Clear



Frosted Blue



Green



Gray



Gray Wood



Light Wood



Allergen
Purple



Red



Satin Chrome

SUMMIT CUSTOM PRE-APPROVED COLORS



Black



White



Brown



Yellow



Orange



Red



SN

Sand



SS

Stainless Steel
(Counter Service)



SS

Stainless Steel Look
(Washroom)



TBK

Black Pearl



TBL

Arctic Blue



TBR

Bronze



TC

Tuff Cut
Material



TP

Taupe



WH

White



WHCL

White Clear



WN

Wine



WW

Warm Wood



X

Satin
Stainless



XC

Chrome



YL

Yellow



MN

Maroon



PR

Purple



BL

Blue



DB

Dark Blue



GN

Green



DG

Dark Green

RECENT INNOVATIONS

Summit™ Simplicity
Essence



PAGE 13

Oceans® Simplicity
Essence



PAGE 13

Classic Simplicity
Essence



PAGE 13

Summit™ Hybrid



PAGE 15

Classic Hybrid



PAGE 15

Summit™ Tear-N-Dry with
Ad Insert



PAGE 15

Recessed Roll
Towel
Dispensers



PAGE 16

Summit™ Lever



PAGE 18

Summit™ Ultrafold
Multifold/C-Fold
Towel



PAGE 20

Premium Covered
Countertop
Towel



PAGE 21

Summit™
Versatwin®



PAGE 25

Summit™ Rely®



PAGE 31

Summit™ Rely®
Manual Soap &
Sanitizer
Dispenser



PAGE 31

Kleen Keeper™
Wet Wipe
Dispenser



PAGE 33

Modular Straw &
Napkin
Combo



PAGE 41

Stainless
Steel
Counter-Mount
Beverage Cup



PAGE 53

Portion Cup & Lid
Organizer



PAGE 61

Modular Organizer



PAGE 63

Modular Mini
Dome®
Series



PAGE 64

Modular ModPan™
Series



PAGE 64

Modular Bulk FIFO
Dispenser



PAGE 64

Modular FrontLine™
Pump/Accessories



PAGE 65

Modular Graphics
Holder



PAGE 66

Venue® Coffee
Sleeve
Dispenser



PAGE 66

Earth Tray™



PAGE 69

BPA Free
Saf-T-Ice®
Tote



PAGE 80

Saf-T-Scoop®
Alarm
Monitoring
System



PAGE 83

Saf-T-Label™
Dispenser



PAGE 88

Kleen-Pail® Pro



PAGE 91

Kleen-Pail® Pro
Stands



PAGE 91

Kleen-Pail® Broken
Glass Container



PAGE 93

Sparta® Spectrum®
Cutting Board
Brushes



PAGE 103

Perfect Pitcher™



PAGE 108

Fryer Basket
Identifier



PAGE 116

Lettuce Korner™



PAGE 117

SlimLine™ Digital
Scale



PAGE 135

Legal For Trade
Scale



PAGE 136

L-Series High
Precision Scale



PAGE 137

Square Professional
Digital Scale



PAGE 137

Digital Washdown
Scale



PAGE 139

HACCP Colored
Scale Platforms



PAGE 140

Folding Digital
Thermometer



PAGE 141

Waterproof Digital
Thermometer



PAGE 141

Wireless Remote
Thermometer and
Timer



PAGE 141

Oven Safe Meat
Thermometer



PAGE 143

Mini Fridge/Freezer
Thermometer



PAGE 145

Digital Thermometer
& Mini Digital Timer
Display
Units



PAGE 146,147

FlexGuard™ Oven
Mitt



PAGE 151

EZ-Kleen™
Oven Mitt



PAGE 152

EZ-Kleen™
Sleeve



PAGE 159

EZ-Kleen™
Hot Pad



PAGE 161

Silicone Handle
Holder



PAGE 165

Mani-Kare®
Bandage Dispenser



PAGE 167

Bag Boa™ Bag
Cutter & Squeegee



PAGE 169

EZ-Kleen™
Apron



PAGE 173

EZ-Kleen™ Shin
Guards



PAGE 179

EZ-Kleen™ Face
Shield



PAGE 179

EZ-Kleen™ Kit



PAGE 179

RECENT INNOVATIONS

WASHROOM & HYGIENE SOLUTIONS

An efficient, sanitary washroom environment starts with clean, contemporary dispensing solutions. San Jamar offers innovative ways to provide worry-free dispensing crafted with high quality materials that improve hygiene, cut costs and enhance your image.

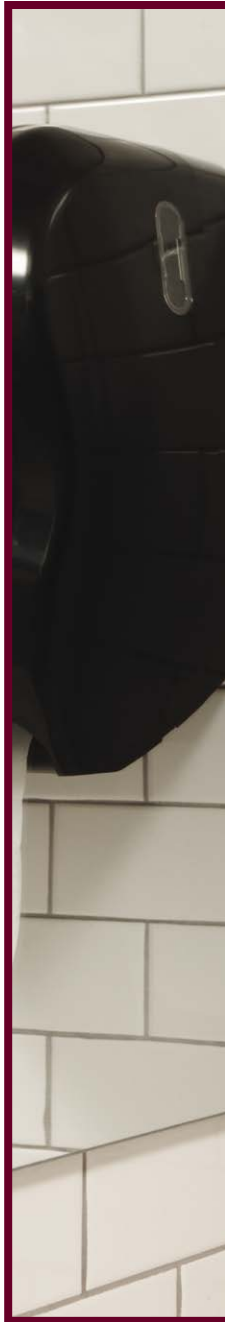

**TOWEL
DISPENSERS**

**TISSUE
DISPENSERS**



**SOAP & OTHER
DISPENSERS**

AIR CARE

THE SUMMIT™ FAMILY IS GROWING

BLACK/STAINLESS LOOK



STAINLESS LOOK



WHITE/CLEAR

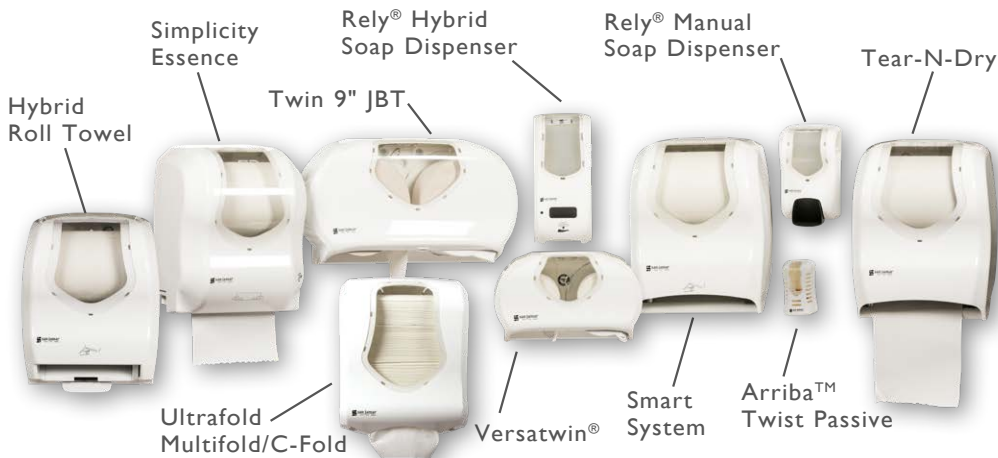

NEW

as featured on
page 29



Summit™ 9" JBT
R2070BKSS, R2070SS,
R2070WHCL

**COMING
2019**



Summit™ Lever
T970BKSS, T970SS,
T970WHCL

SUMMIT™ FAMILY CUSTOM OPTIONS

Visit Sanjamar.com/Summit to design your own dispenser and washroom. Or, go to the Apple or Android App Store to download our Summit™ App. See how Summit™ products fit in your Washroom.

Artwork can be molded into shield

LOW MINIMUMS

FAST TURN AROUND

with 12 pre-approved colors for back, cover & shield

BK Black	WH White	BR Brown	YL Yellow	OR Orange	RD Red
MN Maroon	PR Purple	BL Blue	DB Dark Blue	GN Green	DG Dark Green

Custom items have minimum purchase of 50 each.



CALL US TO ORDER! 1-800-248-9826

TOWEL DISPENSERS

NO-TOUCH ROLL TOWEL

TOUCH ROLL TOWEL

FOLDED TOWEL

NO-TOUCH ROLL TOWEL

- Touchless towel dispensers offer the best option for sanitary hand hygiene
- San Jamar leads the industry in Universal Touchless Electronic dispensing with four options: Smart Essence™, Tear-N-Dry Essence™, Smart System with I.Q. Sensor™, and the Tear-N-Dry. Each of these durable dispensers offer:
 - Best battery life in industry
 - Fast, reliable performance
 - Dispensing all types of 8" roll towel paper up to 800' – any brand or quality





FEATURES STATE OF ART MECHANICAL
HANDS-FREE DISPENSING

Simplicity Essence Hands-Free Mechanical **NEW**

- Offers hands-free dispensing of most types of roll towel
- No batteries for easy maintenance
- Dispenses 10" (254 mm) portions of towel for 15% more dries per roll

ITEM	COLOR	CAPACITY	CORE DIAMETER	DIMENSIONS
CLASSIC STYLE				
T7400*	TBK	8" (200 mm) wide roll	1½" (38 mm)	14.625" H x 12.375"W x 9.5"D (371 x 314 x 241 mm)
OCEANS® STYLE				
T7490*	TBK	8" (200 mm) wide roll	1½" (38 mm)	14.625"H x 12.375"W x 9.5"D (371 x 314 x 241 mm)
SUMMIT™ STYLE				
T7470*	BKSS, SS, WHCL, CUSTOM	8" (200 mm) wide roll	1½" (38 mm)	14.57"H x 12.25"W x 9.25"D (370 x 310 x 232 mm)

* Specify desired color after item number. Example: T7470WHCL

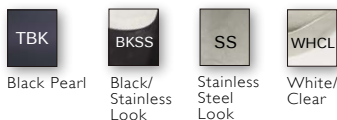



Smart System WITH I.Q. SENSOR™

- Adjustable paper length (8", 12", 16") and delay (0, 1½, 3 seconds)
- Infinity System® automatic transfer system eliminates stub roll waste
- Replaceable drive module

ITEM	COLOR	CAPACITY	CORE DIAMETER	DIMENSIONS
CLASSIC STYLE				
T1400*	TBL, TBK, WH	8" (200 mm) wide roll dia. & 4" (100 mm) dia. stub roll	1½" (38 mm)	16½"H x 11¾"W x 9¼"D (419 x 298 x 235 mm)
T1400TBKHW**	TBK	8" (200 mm) wide roll dia. & 4" (100 mm) dia. stub roll	1½" (38 mm)	16½"H x 11¾"W x 9¼"D (419 x 298 x 235 mm)
OCEANS® STYLE				
T1490*	TBL, TBK	8" (200 mm) wide roll dia. & 4" (100 mm) dia. stub roll	1½" (38 mm)	16½"H x 11¾"W x 9¼"D (419 x 298 x 235 mm)
SUMMIT™ STYLE				
T1470*	BKSS, SS, WHCL, CUSTOM	8" (200 mm) wide roll dia. & 4" (100 mm) dia. stub roll	1½" (38 mm)	16½"H x 12¼"W x 9¼"D (410 x 311 x 248 mm)

Requires 4 D-cell alkaline batteries

**Includes hand washing sticker



Smart Essence™

- Adjustable paper length (8", 12", 16") and delay (0, 1½, 3 seconds)
- Compact, high capacity
- Durable and economical

ITEM	COLOR	CAPACITY	CORE DIAMETER	DIMENSIONS
CLASSIC STYLE				
T8400*	TBL, TBK, WH	(1) 8" (200 mm) wide roll	1½" (38 mm)	147/16"H x 11¾"W x 9½"D (367 x 298 x 232 mm)
OCEANS® STYLE				
T8490*	TBL, TBK	(1) 8" (200 mm) wide roll	1½" (38 mm)	147/16"H x 11¾"W x 9½"D (367 x 298 x 232 mm)

Requires 4 D-cell alkaline batteries



Hybrid Roll Towel

- Touchless electronic towel dispensing
- Adjustable paper length (8", 12", 16") and delay (0, 1½, 3 seconds)
- Manual "Push" bar operation when batteries are low

ITEM	COLOR	CAPACITY	CORE DIAMETER	DIMENSIONS
CLASSIC STYLE				
T8300TBK	TBK	(1) 8" (200 mm) wide roll	1½" (38 mm)	16½"H x 13"W x 9¼"D (419 x 330 x 235 mm)
SUMMIT™ STYLE				
T8370*	BKSS, SS, WHCL	(1) 8" (200 mm) wide roll	1½" (38 mm)	16½"H x 13"W x 9¼"D (419 x 330 x 235 mm)

Requires 4 D-cell alkaline batteries



Tear-N-Dry

- Consistently dispenses standard 10" length paper without a wait
- Infinity System® automatic transfer system eliminates stub roll waste
- Replaceable drive module

ITEM	COLOR	CAPACITY	CORE DIAMETER	DIMENSIONS
CLASSIC STYLE				
T1300*	TBL, TBK	8" (200 mm) wide roll dia. and 3.5" (100 mm) dia. stub roll	1½" (38 mm)	16½"H x 11¾"W x 9¼"D (419 x 298 x 235 mm)
OCEANS® STYLE				
T1390*	TBL, TBK	8" (200 mm) wide roll dia. and 3.5" (100 mm) dia. stub roll	1½" (38 mm)	16½"H x 11¾"W x 9¼"D (419 x 298 x 235 mm)
SUMMIT™ STYLE				
T1370*	BKSS, SS, WHCL, CUSTOM	8" (200 mm) wide roll dia. and 3.5" (100 mm) dia. stub roll	1½" (38 mm)	16½"H x 12¼"W x 9¼"D (410 x 311 x 248 mm)
SUMMIT™ WITH AD INSERT				
T1370WHCLAI	WHCL	8" (200 mm) wide roll dia. and 3.5" (100 mm) dia. stub roll	1½" (38 mm)	16½"H x 12¼"W x 9¼"D (410 x 311 x 248 mm)
T1370BKBKCLAI	BKBKCL	8" (200 mm) wide roll dia. and 3.5" (100 mm) dia. stub roll	1½" (38 mm)	16½"H x 12¼"W x 9¼"D (410 x 311 x 248 mm)

Requires 4 D-cell alkaline batteries



* Specify desired color after item number. Example: T1400TBK

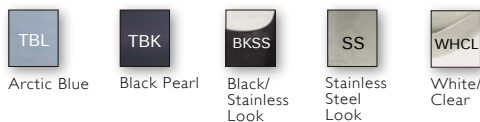



Tear-N-Dry Essence™

- Consistently dispenses standard 10" length paper without a wait
- Compact, high capacity
- Durable and economical

ITEM	COLOR	CAPACITY	CORE DIAMETER	DIMENSIONS
CLASSIC STYLE				
T8000*	TBL, TBK, WH	(1) 8" (200 mm) wide roll	1½" (38 mm)	147/16"H x 11¾"W x 9½"D (367 x 298 x 232 mm)
OCEANS® STYLE				
T8090*	TBL, TBK	(1) 8" (200 mm) wide roll	1½" (38 mm)	147/16"H x 11¾"W x 9½"D (367 x 298 x 232 mm)

Requires 4 D-cell alkaline batteries



WASHROOM & HYGIENE SOLUTIONS



Recessed Roll Towel **NEW**

- ADA (6" diameter rolls) or Universal (8" diameter rolls) installations available
- Available for built in or retrofit a folded towel cabinet with money saving roll towel dispenser
- Two operating systems: Tear-N-Dry System or Smart System

ITEM	COLOR	CAPACITY	CORE DIAMETER	DIMENSIONS
TEAR-N-DRY SYSTEM				
T8006BKADA	Black	6" (152 mm) wide roll dia.	1½" (38 mm)	17¾"H x 14½"W x 7¾"D (448 x 368 x 187 mm) 3½" (89 mm) off the wall
T8008BKUNV	Black	8" (203 mm) wide roll dia.	1½" (38 mm)	17¾"H x 14½"W x 9¾"D (448 x 368 x 238 mm) 5" (127 mm) off the wall
SMART SYSTEM				
T8406SSADA	Stainless Look	6" (152 mm) wide roll dia.	1½" (38 mm)	17¾"H x 14½"W x 7¾"D (448 x 368 x 187 mm) 3½" (89 mm) off the wall
T8408SSUNV	Stainless Look	8" (203 mm) wide roll dia.	1½" (38 mm)	17¾"H x 14½"W x 9¾"D (448 x 368 x 238 mm) 5" (127 mm) off the wall
STAINLESS STEEL FILTER PLATE				
XT800SS	Stainless Steel 20 GAG			6"H x 15"W (152 x 318 mm)

Requires 4 D-cell alkaline batteries



Adjustable Centerpull Towel

- Easy to adjust funnel
- High capacity (9" diameter roll)
- Universal centerpull dispenser, adjusts for all grades of paper from single ply to industrial wipes

ITEM	COLOR	CAPACITY	DIMENSIONS
T410*	TBL, TBK	9" (229 mm) wide; 9" (229 mm) dia. roll	13 $\frac{1}{2}$ "H x 9 $\frac{3}{8}$ " W x 9 $\frac{3}{8}$ " D (340 x 244 x 238 mm)

Construction: Impact resistant plastic



T410TBK

Adjustable Mini Centerpull Towel

- Easy to adjust funnel
- Compact (6" diameter roll)
- Universal centerpull dispenser, adjusts for all grades of paper from single ply to industrial wipes

ITEM	COLOR	CAPACITY	DIMENSIONS
T450*	TBL, TBK	6" (152 mm) dia. roll	12 $\frac{3}{8}$ "H x 7 $\frac{1}{2}$ " W x 7 $\frac{3}{8}$ " D (314 x 190 x 187 mm)

Construction: Impact resistant plastic



T450TBL

Centerpull Towel

- Large capacity ensures long intervals between refills
- Dispenses single sheets of one-ply perforated towels

ITEM	COLOR	CAPACITY	DIMENSIONS
T400*	TBL, TBK	9" (229 mm) wide; 9" (230 mm) dia. roll	11 $\frac{5}{8}$ "H x 9 $\frac{3}{8}$ " W x 9 $\frac{1}{2}$ " D (295 x 232 x 241 mm)

Construction: Impact resistant plastic



T400TBK

Perforated Roll Towel

ITEM	COLOR	CAPACITY	DIMENSIONS
T451XC	XC	11" (280 mm) wide roll	2 $\frac{7}{8}$ "H x 13 $\frac{3}{4}$ "W x 4 $\frac{3}{8}$ " D (73 x 337 x 117 mm)

Construction: 24-gauge steel



* Specify desired color after item number. Example: T8000TBL

TBL	TBK	BK	BkSS	SS	XC
Arctic Blue	Black Pearl	Black	Black/ Stainless Look	Stainless Steel Look	Chrome

TOUCH ROLL TOWEL

- Lowest cost way to dispense the lowest cost paper, hardwound roll towel
- Engineered for ease of use and minimal maintenance
- Impact resistant plastic for durability



T970BKSS

Summit™ Lever Roll Towel **NEW**

- Available in Standard and Custom Summit Colors

ITEM	COLOR	CAPACITY	CORE DIAMETER	DIMENSIONS
T970*	BKSS, SS, WHCL, CUSTOM	8" (200 mm) wide; 8" (200 mm) dia. roll	1½" (38 mm)	13.6"H x 13.6" W x 9.1"D (345 x 345 x 231 mm)

Construction: Impact resistant plastic



T950TBL

Element™ Lever Roll Towel

- Compact, high capacity - 33% smaller than average roll towel dispenser
- Ergonomic handle; simple, efficient & easy to use
- Accepts any core size, including coreless, solid & centerpull rolls

ITEM	COLOR	CAPACITY	CORE DIAMETER	DIMENSIONS
CLASSIC STYLE				
T950*	TBL, TBK	8" (200 mm) wide; 8" (200 mm) dia. roll	All paper qualities, any size core	12¾"H x 12½" W x 8½"D (324 x 318 x 216 mm)
OCEANS® STYLE				
T990*	TBL, TBK	8" (200 mm) wide; 8" (200 mm) dia. roll	All paper qualities, any size core	12¾" H x 12½" W x 8½"D (324 x 318 x 216 mm)

Construction: Impact resistant plastic



T1190TBL

T1100TBK

Lever Roll Towel WITH AUTO TRANSFER

- Infinity System® automatic transfer system eliminates stub roll waste
- Replaceable drive module
- Simple, efficient & easy to use

ITEM	COLOR	CAPACITY	CORE DIA.	DIMENSIONS
CLASSIC STYLE				
T1100*	TBL, TBK, WH	8" (200 mm) wide; 8" (200 mm) dia. roll Up to 4" dia. (100 mm) stub roll	1½" (38 mm)	16½"H x 12 ¹⁵ / ₁₆ " W x 9¾"D (419 x 329 x 235 mm)
OCEANS® STYLE				
T1190*	TBL, TBK	8" (200 mm) wide; 8" (200 mm) dia. roll Up to 4" dia. (100 mm) stub roll	1½" (38 mm)	16½" H x 12 ¹⁵ / ₁₆ " W x 9¾"D (419 x 329 x 235 mm)

Construction: Impact resistant plastic

Integra™ Lever Roll Towel

- Integrated dispensing arm for hands-free alternative dispensing
- Compact, high capacity
- Accepts any core size, including coreless, solid and centerpull rolls

ITEM	COLOR	CAPACITY	CORE DIAMETER	DIMENSIONS
T850*	TBL, TBK	8½" (215 mm) dia. 8¼" (209 mm) wide	All paper qualities, any size core	13½" H x 11½" W x 11¼"D (342 x 292 x 285 mm)

Construction: Impact resistant plastic



T850TBL

Crank Roll Towel

ITEM	COLOR	CAPACITY	DIMENSIONS
T800WH	WH	9" (230 mm) wide roll; 7¾" (197 mm) dia. roll	10½" H x 11"W x 8½"D (267 x 279 x 216 mm)

Construction: 20-gauge steel



* Specify desired color after item number. Example: T970TBL

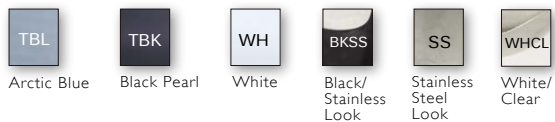

FOLDED TOWEL

- Available in a variety of sizes for compact or high capacity applications
- Designed to dispense any brand or quality of C-Fold or Multifold towels one-at-a-time, reducing waste
- Designed to eliminate overstuffing
- Impact resistant plastic for durability



T1770BKSS

Summit™ Ultrafold™ Multifold/C-Fold Towel **NEW**

- New Summit design coordinates with Summit family
- Designed to eliminate overstuffing

ITEM	COLOR	CAPACITY	DIMENSIONS
T1770*	BKSS, SS, WHCL, CUSTOM	500 Multifold /300 C-Fold	14"H x 11" W x 6"D (356 x 279 x 152 mm)

Construction: Impact resistant plastic



T1755TBK

Ultrafold™ Fusion™ Multifold/C-Fold Towel

- 50% smaller carton to save on warehouse and transportation costs
- Simple, 6 piece assembly

ITEM	COLOR	CAPACITY	DIMENSIONS
T1755*	TBL, TBK	400 Multifold /240 C-Fold	11½"H x 11½" W x 6"D (292 x 292 x 152 mm)

Construction: Impact resistant plastic



T1750TBL

T1759TBK

Ultrafold™ Multifold/C-Fold Towel

- Compact
- Saves money with less towel waste

ITEM	COLOR	CAPACITY	DIMENSIONS
CLASSIC STYLE			
T1750*	TBL, TBK, WH	400 Multifold / 240 C-Fold	11½" H x 11½" W x 6"D (292 x 292 x 152 mm)
OCEANS® STYLE			
T1759*	TBL, TBK	400 Multifold / 240 C-Fold	11½" H x 11½" W x 6"D (292 x 292 x 152 mm)

Construction: Impact resistant plastic



Large Capacity Ultrafold™ Multifold/C-Fold Towel

- High capacity, reduces need to refill frequently

ITEM	COLOR	CAPACITY	DIMENSIONS
CLASSIC STYLE			
T1700*	TBL, TBK	750 Multifold / 450 C-Fold	18"H x 11¾"W x 6¼"D (475 x 298 x 159 mm)
OCEANS® STYLE			
T1790*	TBL, TBK	750 Multifold / 450 C-Fold	18"H x 11¾"W x 6¼"D (475 x 298 x 159 mm)

Construction: Impact resistant plastic



Premium Covered Countertop Towel Dispenser **NEW**

- Compact, ideal for spaces where wall mount dispensers are not an option
- Low Level Indicator tells when to replace towels

ITEM	COLOR	CAPACITY	DIMENSIONS
T1740*	BK, WH, SS	(1) Stack Multifold/C-fold/Singlefold. Holds up to 1.5 stacks of C-fold/Multifold towels	8½"H x 12"W x 5½"D (178 x 279 x 111 mm)

Construction: Impact resistant plastic



Countertop Towel

- Compact, ideal for spaces where wall mount dispensers are not an option
- Protects against moisture and contaminates

ITEM	COLOR	CAPACITY	DIMENSIONS
T1720*	TBK, BK, WH	(1) Stack Multifold/C-fold/Singlefold	7"H x 11"W x 4¾"D (178 x 279 x 111 mm)

Construction: Impact resistant plastic



* Specify desired color after item number. Example: T1750TBL

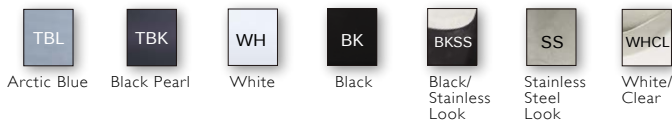

WASHROOM & HYGIENE SOLUTIONS



T1905XC

True Fold™ C-Fold/Multifold Towel

- Operator-friendly flip door eliminates towel waste

ITEM	COLOR	CAPACITY	DIMENSIONS
T1905*	XC, WH	500 Multifold / 300 C-fold	14½" H x 11½"W x 5"D (368 x 295 x 127 mm)

Construction: metal front/impact resistant plastic back



T1900XC

C-Fold/Multifold Towel

ITEM	COLOR	CAPACITY	DIMENSIONS
T1900*	XC, SS	500 Multifold / 300 C-fold	14¾"H x 11¾"W x 4"D (375 x 289 x 102 mm)

Construction: 20-gauge steel



Mini C-Fold/Multifold Towel

ITEM	COLOR	CAPACITY	DIMENSIONS
T1950XC	XC	250 Multifold / 150 C-fold	7½"H x 11½"W x 3¾"D (200 x 283 x 98 mm)

Construction: 20-gauge steel



T1950XC

Singlefold Towel

ITEM	COLOR	CAPACITY	DIMENSIONS
T1800*	XC, WH	500 Singlefold	7½"H x 10¾"W x 6"D (191 x 273 x 152 mm)

Construction: 20-gauge steel



T1800XC

T1800WH

* Specify desired color after item number. Example:T1800XC



White



Chrome



Stainless
Steel
Look

TISSUE DISPENSERS

STANDARD BATH TISSUE

JUMBO BATH TISSUE

STANDARD BATH TISSUE

- Standard bath tissue dispensers offer a professional looking solution for dispensing both standard or industrial bath tissue





R3600TBL



R3690TBK



R3670BKSS

Versatwin[®] Tissue

- Accepts standard/industrial bath tissue
- Continual availability of paper provided by the Infinity System[®] eliminating stub roll waste

ITEM	COLOR	CAPACITY	CORE DIAMETER	DIMENSIONS
CLASSIC STYLE				
R3600*	TBL, TBK	(2) 4½-5½" (115-140 mm) rolls	Min. 1½" (38 mm)	8"H x 12¾"W x 5¾"D (203 x 34 x 146 mm)
OCEANS [®] STYLE				
R3690*	TBL, TBK	(2) 4½-5½" (115-140 mm) rolls	Min. 1½" (38 mm)	8"H x 12¾"W x 5¾"D (203 x 34 x 146 mm)
SUMMIT [™] STYLE NEW				
R3670*	BKSS, SS, WHCL, CUSTOM	(2) 4½-5½" (115-140 mm) rolls	Min. 1½" (38 mm)	7¾"H x 12¾"W x 5¾"D (196 x 328 x 149 mm)

* Specify desired color after item number. Example: R3600TBL



Arctic Blue



Black Pearl



White



Black/
Stainless
Look



Stainless
Steel
Look



White/
Clear



R3500TBK



R3590TBL

Duett Standard Bath Tissue

- Accepts standard/industrial bath tissue
- Continual availability of paper provided by the Infinity System[®], eliminating stub roll waste
- Compact design

ITEM	COLOR	CAPACITY	CORE DIAMETER	DIMENSIONS
CLASSIC STYLE				
R3500*	TBL, TBK	(2) 4½-5½" (115-140 mm) rolls	1½" (40 mm)	12¾"H x 7½"W x 7"D (324 x 191 x 178 mm)
OCEANS [®] STYLE				
R3590*	TBL, TBK	(2) 4½-5½" (115-140 mm) rolls	1½" (40 mm)	12¾"H x 7½"W x 7"D (324 x 191 x 178 mm)

Construction: Impact resistant plastic



R3800TBK

4-Station Carousel

- Multiple roll system to reduce run-outs and waste
- High capacity, holds four 5" rolls of standard bath tissue
- Uses rolls sequentially to eliminate stub roll waste

ITEM	COLOR	CAPACITY	CORE DIAMETER	DIMENSIONS
R3800*	TBK	(4) standard rolls	Min. 1½" (38 mm)	14⅞"H x 13⅝"W x 6⅞"D (378 x 333 x 156 mm)

Construction: Impact resistant plastic

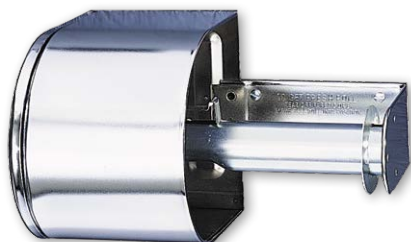

R1500XC

Covered Reserve Roll Tissue

ITEM	COLOR	CAPACITY	CORE DIAMETER	DIMENSIONS
R1500*	XC	(2) standard rolls	Min. 1½" (38 mm)	6"H x 10"W x 6¼"D (152 x 254 x 159 mm)

Construction: 20-gauge steel

Locking Toilet Tissue

- Accommodates 4" (102 mm) wide roll

ITEM	COLOR	CAPACITY	CORE DIAMETER	DIMENSIONS
R200XC	XC	(1) standard rolls	Min. 1½" (38 mm)	2¾"H x 6"W x 4½"D (70 x 152 x 114 mm)
R260XC	XC	(2) standard rolls	Min. 1½" (38 mm)	2¾"H x 12¾"W x 4½"D (70 x 314 x 114 mm)

Construction: 20-gauge steel



Non-Locking Toilet Tissue

- Accommodates 4.5" (114 mm) wide roll

ITEM	COLOR	CAPACITY	CORE DIAMETER	DIMENSIONS
R1200XC	XC	(1) standard rolls	Min. 1½" (38 mm)	2½"H x 6¼"W x 4⅞"D (64x 159 x 124 mm)

Construction: 20-gauge steel



* Specify desired color after item number; Example: R3500TBL

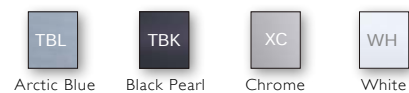

JUMBO BATH TISSUE



R4000TBL

R4070WHCL

Twin 9" JBT

- Industry leading dispenser
- Continual availability of paper provided by the Infinity System®, eliminating stub roll waste

ITEM	COLOR	CAPACITY	CORE DIA.	DIMENSIONS
CLASSIC STYLE				
R4000*	TBL, TBK	(2) 9" (230 mm) JBT rolls	Min. 3¼" (83 mm)	12"H x 19"W x 5¼"D (305 x 483 x 133 mm)
OCEANS® STYLE				
R4090*	TBL, TBK	(2) 9" (230 mm) JBT rolls	Min. 3¼" (83 mm)	12"H x 19"W x 5¼"D (305 x 483 x 133 mm)
SUMMIT™ STYLE				
R4070*	BKSS, SS, WHCL, Custom	(2) 9" (230 mm) JBT rolls	Min. 3¼" (83 mm)	11 ⁹ / ₁₆ "H x 20 ¹ / ₄ "W x 5 ⁵ / ₈ "D (300 x 514 x 149 mm)

Construction: Impact resistant plastic



R3000TBK

Twin 10" JBT

- High capacity dispensing of toilet tissue for high traffic environments
- Continual availability of paper provided by the Infinity System, eliminating stub roll waste

ITEM	COLOR	CAPACITY	CORE DIA.	DIMENSIONS
CLASSIC STYLE				
R5000*	TBK	(2) 10" (254 mm) JBT rolls	Min. 3¼" (83 mm)	13.24"H x 21.72"W x 5.25"D (336 x 552 x 141 mm)

Construction: Impact resistant plastic



R3090TBL

Reserva® 9"-10½" JBT

- Holds one 9-10½" (230-270 mm) jumbo bath roll and one 5" (127 mm) single stub roll
- Continual availability of paper provided by the Infinity System, eliminating stub roll waste

ITEM	COLOR	CAPACITY	CORE DIA.	DIMENSIONS
CLASSIC STYLE				
R3000*	TBL, TBK	(1) 9-10½" (230-270 mm) JBT roll (1) 5" (127 mm) stub roll	Min. 3¼" (83 mm)	13½"H x 16½"W x 5½"D (343 x 419 x 143 mm)
OCEANS® STYLE				
R3090*	TBL, TBK	(1) 9-10½" (230-270 mm) JBT roll (1) 5" (127 mm) stub roll	Min. 3¼" (83 mm)	12¾"H x 16¾"W x 5½"D (311 x 425 x 140 mm)

Construction: Impact resistant plastic

Single 9" JBT

- Designed to provide ease-of-use, with easy paper access and multi-directional tearing

ITEM	COLOR	CAPACITY	CORE DIA.	DIMENSIONS
CLASSIC STYLE				
R2000*	TBL, TBK	(1) 9" (230 mm) JBT roll	3¼" (83 mm)	12"H x 10¼"W x 5⅝"D (305 x 260 x 143 mm)
OCEANS® STYLE				
R2090*	TBL, TBK	(1) 9" (230 mm) JBT roll	3¼" (83 mm)	12"H x 10¼"W x 5⅝"D (305 x 260 x 143 mm)
SUMMIT™ STYLE NEW				
R2070*	BKSS, SS, WHCL, CUSTOM	(1) 9" (230 mm) JBT roll	3¼" (83 mm)	11.85"H x 10.42"W x 5.81"D (305 x 260 x 143 mm)

Construction: Impact resistant plastic



Single 12" JBT

- Designed to provide ease-of-use, with easy paper access and multi-directional tearing
- EZ Turn™ mandrel dispenses large rolls of tissue smoothly

ITEM	COLOR	CAPACITY	CORE DIA.	DIMENSIONS
CLASSIC STYLE				
R6000*	TBL, TBK	(1) 12" (305 mm) JBT roll	3¼" (83 mm)	14⅞"H x 12⅑/10"W x 5⅘"D (378 x 328 x 147 mm)

Construction: Impact resistant plastic



Quantum 12"-13" JBT

- Holds one 12"-13" jumbo bath roll and one 6" stub roll
- Continual availability of paper provided by the Infinity System®, eliminating stub roll waste

ITEM	COLOR	CAPACITY	CORE DIA.	DIMENSIONS
CLASSIC STYLE				
R6500*	TBL, TBK	(1) 12-13" (305-330 mm) JBT roll (1) 6" (180 mm) stub roll	3¼" (83 mm)	16½"H x 22"W x 5⅞"D (419 x 559 x 149 mm)

Construction: Impact resistant plastic



* Specify desired color after item number: Example: R4000TBL

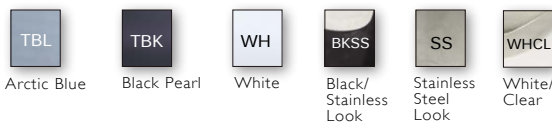

SOAP & OTHER DISPENSERS

SOAP DISPENSERS

OTHER DISPENSERS

SOAP

- Leading the way in solving bulk soap dispensing needs
- Dispensing liquid hand soap, foam soap or sanitizer in dispensers that coordinate with other San Jamar restroom dispensers
- Now taking the San Jamar hands free dispensing expertise into the soap line with Rely Hybrid Soap Dispenser
- Foam, lotion or hand sanitizer



Rely® Hybrid Soap & Sanitizer Dispensers

- Touchless electronic soap & sanitizer dispensing
- Manual "Push-The-Cover" operation when batteries are low
- Accepts bulk hand sanitizers, lotion and foam soap



ITEM	COLOR	CAPACITY	DIMENSIONS	SHF970BKSS
LIQUID & LOTION - CLASSIC STYLE				
SH900*	TBL, TBK	875 ml <i>1 ml or 0.5 ml portion dispensed</i>	12"H x 5.5"W x 4"D (305 x 140 x 102 mm)	
LIQUID & LOTION - SUMMIT™ STYLE				
SH970*	BKSS, SS, WHCL, CUSTOM	875 ml <i>1 ml or 0.5 ml portion dispensed</i>	12"H x 5.5"W x 4"D (305 x 140 x 102 mm)	
FOAM - CLASSIC STYLE				
SHF900*	TBL, TBK	825 ml <i>1 ml or 0.5 ml portion dispensed</i>	12"H x 5.5"W x 4"D (305 x 140 x 102 mm)	
FOAM - SUMMIT™ STYLE				
SHF970*	BKSS, SS, WHCL, CUSTOM	825 ml <i>1 ml or 0.5 ml portion dispensed</i>	12"H x 5.5"W x 4"D (305 x 140 x 102 mm)	

Construction: Impact resistant plastic

Rely® Manual Soap & Sanitizer Dispensers

- Available in 900 & 1300 capacities
- Accepts bulk hand sanitizers, lotion and foam soap
- Mounts easily with adhesive or screws



S970SS

SF1300TBK

ITEM	COLOR	CAPACITY	DIMENSIONS
LIQUID & LOTION - CLASSIC STYLE			
S900*	TBL, TBK	875 ml <i>0.5 ml portion dispensed</i>	8.5"H x 5"W x 4"D (216 x 127 x 102 mm)
S1300*	TBL, TBK	1300 ml <i>0.6 ml portion dispensed</i>	10"H x 5"W x 4"D (254 x 127 x 102 mm)
LIQUID & LOTION - SUMMIT™ STYLE NEW			
S970*	BKSS, SS, WHCL, CUSTOM	875 ml <i>0.6 ml portion dispensed</i>	8.9"H x 5.2"W x 4"D (227 x 132 x 102 mm)
FOAM - CLASSIC STYLE			
SF900*	TBL, TBK	825 ml <i>0.5 ml portion dispensed</i>	8.5"H x 5"W x 4"D (216 x 127 x 102 mm)
SF1300*	TBL, TBK	1300 ml <i>0.6 ml portion dispensed</i>	10"H x 5"W x 4"D (254 x 127 x 102 mm)
FOAM - SUMMIT™ STYLE NEW			
SF970*	BKSS, SS, WHCL, CUSTOM	825 ml <i>0.5 ml portion dispensed</i>	8.9"H x 5.2"W x 4"D (227 x 132 x 102 mm)

Construction: Impact resistant plastic

* Specify desired color after item number; Example: SH900TBK

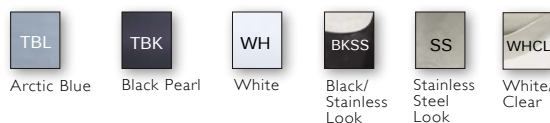



S890TBL

S890TBK

Oceans® Soap & Hand Sanitizer Dispensers

- Accommodates bulk or most 800 ml bag-in-box cartridges
- Accepts bulk hand sanitizers or lotion soap
- Mounts easily with adhesive or screws

ITEM	COLOR	CAPACITY	DIMENSIONS
OCEANS® STYLE			
S890*	TBL, TBK	800 ml (can hold some 1000 ml bags) 0.9 ml portion dispensed	10½"H x 4½"W x 4¾"D (267 x 114 x 111 mm)

Construction: Impact resistant plastic



S30TBK

Soap Dispensers - Lotion, Liquid or Foam

- Accommodates a wide variety of liquid, lotion (except pumice) and foam soaps
- Large push bar allows for easy dispensing

ITEM	COLOR	CAPACITY	DIMENSIONS
LIQUID & LOTION			
S30*	TBL, TBK	30 oz. (0.9 l) 0.8 ml portion dispensed	6½"H x 4¾"W x 4¼"D (156 x 105 x 108 mm)
S46*	TBL, TBK	46 oz. (1.4 l) 0.6 ml portion dispensed	8"H x 5¾"W x 4½"D (206 x 137 x 108 mm)
FOAM			
SF30*	TBL, TBK	30 oz. (0.9 l) 0.4 ml portion dispensed	6½"H x 4¾"W x 4¼"D (156 x 105 x 108 mm)

Construction: Impact resistant plastic



Handwashing Station Value Pack

- Convenient solution to ensure employees have the tools to properly wash their hands

ITEM	INCLUDES
T1730TBK	(1) T1700TBK Ultrafold™ Towel Dispenser with handwashing instructions sticker (1) S900TBK Bulk Soap Dispenser

Construction: Impact resistant plastic

Kleen Keeper™ Wet Wipe Dispensers **NEW**

- Keeps wipes canister in one handy place for storage; but also removable to go where the spills are
- Lid and foot fold flat to wall when not in use
- Prevents theft of canisters - requires removal of canister seal to dispense wipes

ITEM	COLOR	CAPACITY	DIMENSIONS
WD1010*	WH, BKSS, TP	Large wipe canisters - 4" to 5" rim diameter	5¾"H x 7"W (146 x 177 mm) <i>Height will be determined by canister</i>



WD1010BKSS

Toilet Seat Cover Dispensers

- Hygienic and cost effective
- Reliable one-at-a-time dispensing

ITEM	COLOR	CAPACITY	DIMENSIONS
TS510*	TBK	(1) Package standard toilet seat covers	11¾"H x 17¼"W x 3½"D (298 x 438 x 79 mm)

Construction: Impact resistant plastic



TS510TBK

Glove Dispensers

- Prevent boxes from becoming damaged or contaminated

ITEM	COLOR	CAPACITY	CONSTRUCTION
G0801	Stainless Steel	1 Box	22-gauge stainless steel
G0802	White	1 Box	22-gauge steel with white baked enamel
G0804	White	3 Boxes	22-gauge steel with white baked enamel
G0803	Clear	1 Box	High-grade flexible Plexiglas®
G0805	Clear	3 Boxes	High-grade flexible Plexiglas®

Construction: Impact resistant plastic

Plexiglas® is a registered trademark of Rohm and Haas.



G0801



G0802



G0805

* Specify desired color after item number; Example: S30TBL



AIR CARE

ARRIBA™ TWIST AIR CARE

- Arriba Twist System works anywhere you need quality air care and sustainable, earth friendly technology: commercial buildings, restaurants, schools, and healthcare facilities
- Our dispensers combine an innovative Quickload™ design with a unique Advanced Capillary Science™ (ACS) delivery system to ensure consistent 60-day performance



WP 107 80 1202



WP9070BKSS



WP9070SS



WP 107 80 1203

Arriba™ Twist Passive

- No batteries required
- Simple and silent operation

ITEM	COLOR	DIMENSIONS
WP107 80 1202	Gray	2 $\frac{7}{8}$ "H x 4 $\frac{5}{8}$ "W x 2 $\frac{7}{8}$ "D (73 x 117 x 73 mm)
WP107 80 1203	White	2 $\frac{7}{8}$ "H x 4 $\frac{5}{8}$ "W x 2 $\frac{7}{8}$ "D (73 x 117 x 73 mm)
SUMMIT™ STYLE NEW		
WP9070*	BKSS, SS, WHCL, CUSTOM	2 $\frac{7}{8}$ "H x 4 $\frac{5}{8}$ "W x 2 $\frac{7}{8}$ "D (73 x 117 x 73 mm)

* Specify desired color after item number. Example: WP9070BKSS



Gray



White



Black/
Stainless
Look



Stainless
Steel
Look



White/
Clear



WP1202MB

Arriba™ Starter Packs

- Continuous 60 day coverage
- Completely recyclable

ITEM	FRAGRANCE	DESCRIPTION	DIMENSIONS
WP1202MB	Mango Burst	(1) WP107 80 1202 (2) RW107 80 1232	8"H x 3"W x 9"D (203 x 76 x 229 mm)
WP1202TW	Tropic Wave	(1) WP107 80 1202 (2) RW107 80 1228	8"H x 3"W x 9"D (203 x 76 x 229 mm)



Arriba™ Twist Fragrances

- Refills are recyclable
- Easy to change - top is the key just twist and refill
- Fresh scents for washrooms and front of the house areas

ITEM	FRAGRANCE	QUANTITY
RW107 80 1228	Tropic Wave	2.0 fl. oz. (60 ml)
RW107 80 1230	Citrus Blossom	2.0 fl. oz. (60 ml)
RW107 80 1231	Pure Linen	2.0 fl. oz. (60 ml)
RW107 80 1232	Mango Burst	2.0 fl. oz. (60 ml)
RW107 80 1234	Prairie Flowers	2.0 fl. oz. (60 ml)
RW107 80 1255	Cinnamon Stick	2.0 fl. oz. (60 ml)



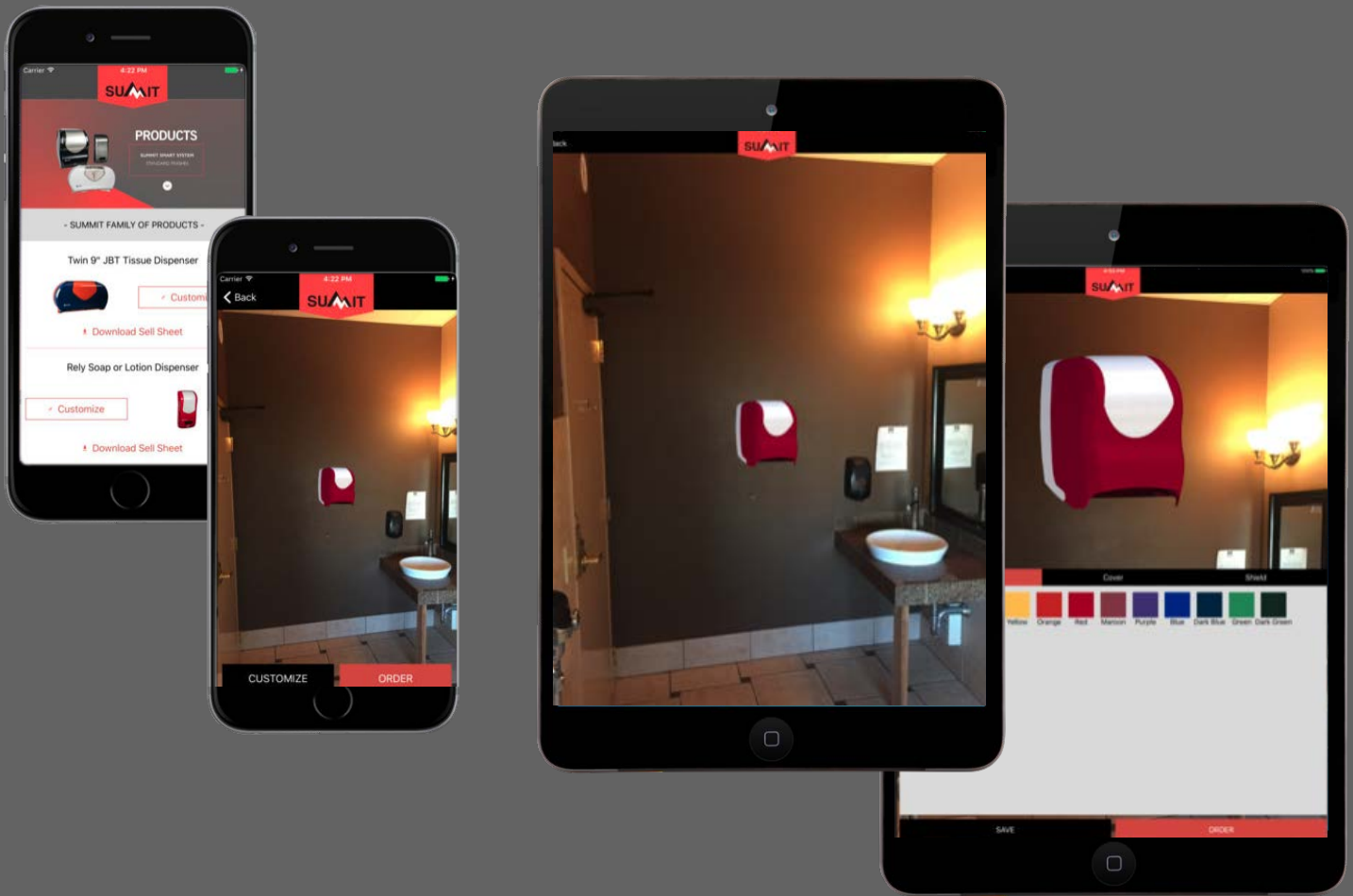

Summit by San Jamar App

Design your own custom washroom dispenser with San Jamar's Summit app. Use your camera to see how your custom dispenser would look in your own environment. Products include San Jamar's towel, tissue, soap and Arriba aircare lines.



Download for free from the App Store or Google Play

COUNTER SERVICE

At San Jamar, innovation and quality come to the forefront when our customers demand solutions to counter service management. One-at-a-time dispensing of cups, lids and napkins is essential when managing costs. As a trusted partner, we are always there to help our customers have a smart, safe and sanitary operation - all provided in the most cost effective way.



**NAPKIN
DISPENSERS**

**CUP, LID
& STRAW
DISPENSERS**



COUNTERTOP
ORGANIZERS

TRAYS

NAPKIN DISPENSERS

COUNTER/WALL MOUNT NAPKIN

IN-COUNTER NAPKIN

TABLETOP NAPKIN

COUNTER/ WALL-MOUNT NAPKIN

- Modular countertop 2-in-1 combination dispensers hold both straws and napkins to save valuable countertop space
- Stackable countertop dispensers save room on your countertop and the unique Wall-Mount Venue® is ideal where space is limited

FULLFOLD & MINIFOLD



CONTROL FACE

INTERFOLD



INTERFOLD FACE

FULLFOLD



CLASSIC FACE

NAPKIN FACEPLATE OPTIONS

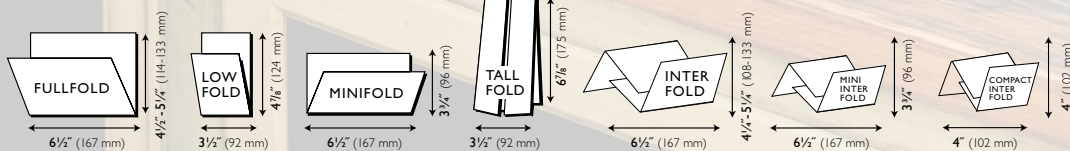

NAPKIN FOLDS AND SIZES



MODH60050GN



MODH6003SN

Modular Straw & Napkin **NEW** Combo Dispensers

- Two-in-one, over-under design reduces footprint & saves space
- Interchangeable lower dispensers to increase utility
- Smooth one-at-a-time napkin dispensing to save napkin waste
- Easy access to straws or condiments

ITEM	DESCRIPTION	NAPKIN TYPE	DIMENSIONS
MODH6003SN	Straw and Napkin Dispenser	Interfold	22.15"H x 9.40"W x 13.63"D (563 x 239 x 346 mm)
MODH60030GN	Organizer and Napkin Dispenser	Interfold	22.15"H x 9.40"W x 13.63"D (563 x 239 x 346 mm)
MODH6005SN	Straw and Napkin Dispenser	Fullfold	22.15"H x 9.40"W x 13.68"D (563 x 239 x 347 mm)
MODH60050GN	Organizer and Napkin Dispenser	Fullfold	22.15"H x 9.40"W x 13.68"D (563 x 239 x 347 mm)





H5005CL

Venue® Countertop Napkin Dispenser

- Stackable design to save counter space
- One-at-a-time dispensing to save napkin waste
- Smooth dispensing down to the last napkin

ITEM	COLOR	TYPE	CAPACITY	DIMENSIONS
H5000*	CL, TBK	Minifold/Control Face	450+	6 $\frac{1}{8}$ "H x 8"W x 15 $\frac{3}{4}$ "D (156 x 203 x 400 mm)
H5003*	CL, TBK	Interfold	450+	7 $\frac{1}{8}$ "H x 8"W x 15 $\frac{3}{4}$ "D (181 x 203 x 400 mm)
H5004*	CL, TBK	Mini Interfold	450+	5 $\frac{7}{8}$ "H x 8"W x 15 $\frac{3}{4}$ "D (149 x 203 x 400 mm)
H5005*	CL, TBK	Fullfold/Control Face	450+	7 $\frac{1}{8}$ "H x 8"W x 15 $\frac{3}{4}$ "D (181 x 203 x 400 mm)

Construction: Impact resistant plastic



H50005STBK

Venue® Napkin Dispenser with Stand

- Stand model enhances image and saves counter space
- One-at-a-time dispensing to save napkin waste
- Smooth dispensing down to the last napkin

ITEM	COLOR	TYPE	CAPACITY	DIMENSIONS
H5000S*	CL, TBK	Minifold/Control Face	450+	17 $\frac{1}{4}$ "H x 8"W x 13"D (440 x 203 x 330 mm)
H5005S*	CL, TBK	Fullfold/Control Face	450+	17 $\frac{3}{8}$ "H x 8"W x 13"D (441 x 203 x 330 mm)

Construction: Impact resistant plastic



Venue® Wall Model Napkin Dispenser

- Mount to the wall to save valuable counter space
- One-at-a-time dispensing to save napkin waste
- Smooth dispensing down to the last napkin

ITEM	COLOR	TYPE	CAPACITY	DIMENSIONS
H5000P*	CL, TBK	Minifold/Control Face	500+	15¼"H x 8"W x 6½"D (400 x 203 x 156 mm)
H5003P*	CL, TBK	Interfold	500+	15¼"H x 8"W x 7½"D (400 x 203 x 181 mm)
H5004P*	CL, TBK	Mini Interfold	500+	15¼"H x 8"W x 5⅞"D (400 x 203 x 149 mm)
H5005P*	CL, TBK	Fullfold/Control Face	500+	15¼"H x 8"W x 7½"D (400 x 203 x 181 mm)



H5005PCL

Construction: Impact resistant plastic



Countertop Napkin Dispensers

ITEM	COLOR	TYPE	CAPACITY	DIMENSIONS
H3001*	XC, BKC, CLBK, CLXC, TBKBK	Fullfold	300+	5½"H x 7⅞"W x 11"D (140 x 194 x 279 mm)
H3005CLXC	CLXC	Fullfold/Control Face	300+	5½"H x 7⅞"W x 11"D (140 x 194 x 279 mm)



H3001CLBK



H3005CLXC

Construction: (Face) 18-gauge steel or poly carbonate plastic (Body) 20-gauge steel; (Base) high-impact plastic

California Residents: Bisphenol A

WARNING (See Appendix A on page 183)

COUNTER SERVICE

* Specify desired color after item number. Example: H5000CL

FACE	TBK	CL	XC	BODY	XC	BK
	Black Pearl	Clear	Chrome		Chrome	Black

CODE	FACE	BODY
CLBK	Clear	Black
CLXC	Clear	Chrome
TBKBK	Black Pearl	Black
BKC	Chrome	Black
XC	Chrome	Chrome

IN-COUNTER NAPKIN

- In-Counter napkin dispensers mount directly into the counter to save valuable counter space



H2005CLSS

7¹¹/₁₆" (195 mm)
COUNTER HOLE
DIMENSIONS
5¹/₂" (140 mm)

CODE	FACE	BODY
XC	Chrome	Chrome
CLSS	Clear	Stainless Steel
SS	Stainless Steel	Stainless Steel
SC	Satin Chrome	Satin Chrome
TBKSS	Black Pearl	Stainless Steel

In-Counter Napkin Dispensers

- Space-saving design for under the counter provides a neat, professional appearance
- Durable
- One-at-a-time dispensing of napkins

ITEM	COLOR	TYPE	CAPACITY	DIMENSIONS
H2000*	XC, SS, SC, TBKSS	Minifold	750+	19 ⁹ / ₁₆ "H x 7"W x 5 ¹ / ₂ "D (498 x 178 x 140 mm)
H2000SS12	SS	Minifold	450+	13 ³ / ₄ "H x 7"W x 5 ¹ / ₂ "D (349 x 178 x 140 mm)
H2001*	XC, SS, CLSS, SC	Fullfold/Classic Face	750+	19 ⁹ / ₁₆ "H x 7"W x 5 ¹ / ₂ "D (498 x 178 x 140 mm)
H2001CLSS12	CLSS	Fullfold/Classic Face	450+	13 ³ / ₄ "H x 7"W x 5 ¹ / ₂ "D (349 x 178 x 140 mm)
H2001SS12	SS	Fullfold/Classic Face	450+	13 ³ / ₄ "H x 7"W x 5 ¹ / ₂ "D (349 x 178 x 140 mm)
H2005CLSS	CLSS	Fullfold/Control Face	750+	19 ⁹ / ₁₆ "H x 7"W x 5 ¹ / ₂ "D (498 x 178 x 140 mm)
H2003CLSS	CLSS	Interfold	750+	19 ⁹ / ₁₆ "H x 7"W x 5 ¹ / ₂ "D (498 x 178 x 140 mm)
H2003CLSS12	CLSS	Interfold	450+	13 ³ / ₄ "H x 7"W x 5 ¹ / ₂ "D (349 x 178 x 140 mm)

Construction: (Face) 18-gauge steel and ABS plastic; (Body) 22-gauge stainless steel

COUNTER SERVICE



H2003CLSC

7" (178 mm)
COUNTER HOLE
DIMENSIONS
5³/₄" (133 mm)

CODE	FACE	FRAME
CLBK	Clear	Black
CLSC	Clear	Satin Chrome
SC	Satin Chrome	Satin Chrome

Venue® In-Counter Napkin Dispensers

- Control face restricts napkin usage, saving up to 30%
- High capacity, holds over 750 napkins
- Ability to convert easily for variety of napkin types

ITEM	COLOR	TYPE	CAPACITY	DIMENSIONS
H2005CLBK	CLBK	Fullfold/Control Face	750+	20"H x 7 ¹ / ₅ "W x 8 ⁴ / ₅ "D (507 x 184 x 224 mm)
H2003CLBK	CLBK	Interfold	750+	20 ² / ₅ "H x 7 ¹ / ₅ "W x 8 ⁴ / ₅ "D (518 x 184 x 224 mm)
H2003CLBK12	CLBK	Interfold	450+	12"H x 7 ¹ / ₅ "W x 8 ⁴ / ₅ "D (305 x 184 x 224 mm)
H2003CLSC	CLSC	Interfold	750+	20 ² / ₅ "H x 7 ¹ / ₅ "W x 8 ⁴ / ₅ "D (518 x 184 x 224 mm)
H2005SC	SC	Fullfold/Control Face	750+	20"H x 7 ¹ / ₅ "W x 8 ⁴ / ₅ "D (507 x 184 x 224 mm)
H2005CLSC	CLSC	Fullfold/Control Face	750+	20"H x 7 ¹ / ₅ "W x 8 ⁴ / ₅ "D (507 x 184 x 224 mm)

Construction: (Face) ABS plastic; (Body) 22-gauge stainless steel

TABLETOP NAPKIN

- Control and Interfold faceplates provide one-at-a-time dispensing to reduce napkin waste by 30%

Venue® Tabletop Napkin Dispenser

- Includes advertising insert space for in-house promotion
- Available with or without caddy
- Compact design

ITEM	COLOR	TYPE	CAPACITY	DIMENSIONS
H4000TBK	TBK	Minifold	200+	4 $\frac{7}{8}$ "H x 7 $\frac{1}{2}$ "W x 6 $\frac{1}{4}$ "D (124 x 191 x 159 mm)
H4003TBK	TBK	Interfold	200+	6 $\frac{1}{4}$ "H x 7 $\frac{1}{2}$ "W x 6 $\frac{1}{8}$ "D (159 x 191 x 156 mm)
H4004TBK	TBK	Mini Interfold	200+	4 $\frac{7}{8}$ "H x 7 $\frac{1}{2}$ "W x 6 $\frac{1}{4}$ "D (124 x 191 x 159 mm)
H4005TBK	TBK	Fullfold/Control face	200+	6 $\frac{1}{4}$ "H x 7 $\frac{1}{2}$ "W x 6 $\frac{1}{8}$ "D (159 x 191 x 156 mm)
H4006TBK	TBK	Compact Interfold	200+	6 $\frac{3}{8}$ "H x 5 $\frac{1}{2}$ "W x 5 $\frac{1}{4}$ "D (161 x 130 x 132 mm)
H4005CTBK	TBK	Fullfold Dispenser & Caddy	200+	6 $\frac{1}{4}$ "H x 14 $\frac{1}{4}$ "W x 6 $\frac{1}{8}$ "D (159 x 362 x 156 mm)
H400CTBK	TBK	Caddy only	N/A	2 $\frac{3}{4}$ "H x 14 $\frac{1}{4}$ "W x 6 $\frac{1}{8}$ "D (70 x 362 x 156 mm)



H4005CTBK



H4006TBK

Construction: Impact resistant plastic



Tabletop Napkin Dispensers

- Two-sided dispensing for easy accessibility

ITEM	COLOR	TYPE	CAPACITY	DIMENSIONS
22-GAUGE STAINLESS STEEL				
H900*	BK, X	Tallfold	150+	7 $\frac{1}{2}$ "H x 3 $\frac{3}{4}$ "W x 4"D (191 x 95 x 102 mm)
H985*	BK, X	Lowfold	150+	5 $\frac{1}{2}$ "H x 3 $\frac{3}{4}$ "W x 4"D (140 x 95 x 102 mm)
HEAVY GAUGE STEEL				
H4000	XC	Minifold	170+	4 $\frac{1}{2}$ "H x 7 $\frac{3}{4}$ "W x 6"D (114 x 197 x 152 mm)
H4001XC	XC	Fullfold	170+	5 $\frac{3}{4}$ "H x 7 $\frac{3}{4}$ "W x 6"D (146 x 197 x 152 mm)



COUNTER SERVICE

* Specify desired color after item number: Example: H2000XC

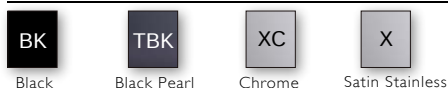

CUP, LID & STRAW DISPENSERS

CUP & LID SYSTEMS

IN-COUNTER CUP

SURFACE-MOUNT CUP

LID & STRAW

CUP & LID SYSTEMS

Sentry® Dispenser cabinets offer:

- Simple adjustment of Lifetime Levers™ provide quick, easy one-at-a-time dispensing
- Easy changes of cup sizes and types

EZ-Fit® Dispenser cabinets offer:

- Interchangeable gaskets that allow for cup sizes and types to be changed easily
- One-at-a-time dispensing
- Replaceable gaskets





L22CS2951BK

Sentry® Beverage & Lid Dispenser Cabinets

- No wear parts to replace
- Adjustable Lifetime Levers™ prevent marring of cups
- Dispenses paper, plastic and foam cups one-at-a-time

ITEM	INCLUDES	DIMENSIONS
BEVERAGE, LID & STRAW CABINET		
L22CS2951BK	(1) C5450C*; (1) L2200C*; (1) straw compartment; black trim rings	22 $\frac{3}{8}$ "H x 7 $\frac{3}{4}$ "W x 25 $\frac{3}{8}$ "D (568 x 197 x 645 mm)
BEVERAGE & LID CABINETS		
L22C2951BK	(1) C5450C*; (1) L2200C*; black trim rings	15 $\frac{1}{8}$ "H x 7 $\frac{3}{4}$ "W x 25 $\frac{3}{8}$ "D (384 x 197 x 645 mm)
L24C2951BK	(1) C5450C*; (1) L2400C*; black trim rings	15 $\frac{1}{8}$ "H x 7 $\frac{3}{4}$ "W x 25 $\frac{3}{8}$ "D (384 x 197 x 645 mm)

Construction: Black polystyrene

*See page 51 for C5450 product details; page 58 for L2200C/L2400C product details



COUNTER SERVICE



Sentry® Beverage Dispenser Cabinets

- Adjustable Lifetime Levers™ prevent marring of cups
- Dispenses paper, plastic and foam cups one-at-a-time

ITEM	INCLUDES	DIMENSIONS
C2951BK	(1) C5450C*; black trim ring	7¼"H x 7¼"W x 23¾"D (197 x 197 x 604 mm)
C2952BK	(2) C5450C*; black trim rings	15½"H x 7¼"W x 23¾"D (384 x 197 x 604 mm)
C2953BK	(3) C5450C*; black trim rings	22¾"H x 7¼"W x 23¾"D (568 x 197 x 604 mm)

Construction: Black polystyrene

*See Page 51 for C5450C product details.



COUNTER SERVICE



Sentry® Stainless Steel Beverage Dispenser Cabinets

- Adjustable Lifetime Levers™ prevent marring of cups
- Dispenses paper, plastic and foam cups one-at-a-time

ITEM	INCLUDES	DIMENSIONS
C2852	(2) C5450C*; black trim rings	16"H x 8½"W x 24¾"D (406 x 206 x 619 mm)
C2853	(3) C5450C*; black trim rings	24¾"H x 8½"W x 24¾"D (616 x 206 x 619 mm)
C2854	(4) C5450C*; black trim rings	30¾"H x 8½"W x 24¾"D (768 x 206 x 619 mm)

Construction: 22-gauge stainless steel

*See Page 51 for C5450C product details.



EZ-Fit® Beverage Dispenser Cabinets

- Easily change cup sizes without having to change dispenser
- Includes a gasket pack to handle wide range of cup sizes
- Dispenses paper, plastic and foam cups one-at-a-time

ITEM	INCLUDES	DIMENSIONS
C2901	(1) C2410C*; metal finish trim ring	7¾"H x 7¾"W x 23¾"D (197 x 197 x 603 mm)
C2901BK	(1) C2410C*; black trim ring	7¾"H x 7¾"W x 23¾"D (197 x 197 x 603 mm)
C2902	(2) C2410C*; metal finish trim rings	15"H x 7¾"W x 23¾"D (381 x 197 x 603 mm)
C2902BK	(2) C2410C*; black trim rings	15"H x 7¾"W x 23¾"D (381 x 197 x 603 mm)
C2903	(3) C2410C*; metal finish trim rings	22¾"H x 7¾"W x 23¾"D (568 x 197 x 603 mm)
C2903BK	(3) C2410C*; black trim rings	22¾"H x 7¾"W x 23¾"D (568 x 197 x 603 mm)



Construction: Black polystyrene
*See Page 51 for C2410C product details.



EZ-Fit® Stainless Steel Beverage Dispenser Cabinets

- Easily change cup sizes without having to change dispenser
- Includes a gasket pack to handle a wide range of cup sizes
- Dispenses paper, plastic and foam cups one-at-a-time

ITEM	INCLUDES	DIMENSIONS
C2802	(2) C2410C*; black trim rings	16"H x 8½"W x 24¾"D (406 x 205 x 619 mm)
C2803	(3) C2410C*; black trim rings	24¾"H x 8½"W x 24¾"D (619 x 205 x 629 mm)
C2804	(4) C2410C*; black trim rings	30¾"H x 8½"W x 24¾"D (768 x 205 x 619 mm)



Construction: 22-gauge stainless steel
*See Page 51 for C2410C product details.



Portion Cup Box System

ITEM	INCLUDES	DIMENSIONS
C9002	(2) C2010C Portion Cup; black trim rings	10½"H x 5½"W x 13"D (256 x 129 x 330 mm)



Construction: 22-gauge stainless steel
*See Page 52 for C2010C product details.



C8503WF & X101924

C8504WFD shown with C8500S & X101924



C8500S

Wireworks™ Cup Dispenser & Lid Organizer

- Lowest cost option for dispensing paper, plastic or foam cups one-at-a-time
- Coils adjust to fit cups ranging from 8-44 ounces
- Available with side panels to prevent contamination

ITEM	DESCRIPTION	DIMENSIONS
BASIC UNIT		
C8503WF	(2) cup dispensers, (1) lid organizer	19¾"H x 6¾"W x 18¼"D (492 x 162 x 464 mm)
C8504WF	(3) cup dispensers, (1) lid organizer	24¾"H x 6¾"W x 18¼"D (620 x 162 x 464 mm)
INCLUDES SIDE PANELS		
C8503WFD	(2) cup dispensers, (1) lid organizer, (2) side panels	19¾"H x 6¾"W x 18¼"D (492 x 162 x 464 mm)
C8504WFD	(3) cup dispensers, (1) lid organizer, (2) side panels	24¾"H x 6¾"W x 18¼"D (620 x 162 x 464 mm)
ACCESSORIES		
X101924	(1) Spindle for domed lids	
X101987	(2) Spindle set for domed lids	
C8500S	Straw organizer kit (cup and caddy)	

Construction: Black epoxy-coated steel



C8003WFS

Cup & Lid Wire Organizers

- Economically organizes all types of beverage cups/lids
- Anti-slip feet keep unit in place
- Includes straw caddy

ITEM	INCLUDES	DIMENSIONS
C8003WF	3 stacks	8½"H x 13¾"W x 5¼"D (216 x 350 x 133 mm)
C8005WF	5 stacks	8½"H x 23¾"W x 5¼"D (216 x 601 x 133 mm)
C8003WFS	3 stacks, (1) straw caddy	8½"H x 17½"W x 5¼"D (216 x 445 x 133 mm)
C8005WFS	5 stacks, (1) straw caddy	8½"H x 27½"W x 5¼"D (216 x 699 x 133 mm)

Construction: 4 and 5 mm black epoxy-coated steel wire



C3604

C3620

Cup & Lid Dispenser Kit & Stand

- Countertop alternative to organize a variety of wall mount cup and lid dispensers
- Holds up to four San Jamar cup/lid dispensers in any configuration

ITEM	INCLUDES	DESCRIPTION	DIMENSIONS
C3620	Kit: C3604, L3402, C3200P, C3400P	Each stand will hold up to four San Jamar cup or lid dispensers in any configuration	36"H x 12"W x 12"D (914 x 305 x 305 mm)
C3604	Stand only		Base: 10" diameter (254 mm)

Construction: (C3604) Chrome-plated steel; (C3200P, C3400P) 26-gauge stainless steel; (L3402) 22-gauge stainless steel

See page 55 for cup dispenser product details.

IN-COUNTER CUP

San Jamar's In-Counter cup dispensers:

- Maximize counter space
- Dispense paper, plastic and foam cups
- Provide one-at-a-time dispensing of a wide variety of cup sizes
- Allows for cup size changes without changing dispensers

Sentry® In-Counter Adjustable Cup Dispenser

- Adjustable Lifetime Levers™ prevent marring of cups and provide one-at-a-time dispensing
- Dispenses paper, plastic and foam cups one-at-a-time

ITEM	CUP RIM DIAMETER	APPROX. CUP SIZE	COUNTER HOLE DIAM.	TUBE LENGTH
C5450C	3⅝" - 4½" (79-114 mm)	8-44 oz. (236-1301 ml)	5¼" (134 mm)	23½" (597 mm)
C5450C18	3⅝" - 4½" (79-114 mm)	8-44 oz. (236-1301 ml)	5¼" (134 mm)	18" (457 mm)

Construction: High-impact plastic

Note: For multiple in-counter units leave a 7¼" (184 mm) space between each unit.



C5450C

Euro Sentry® In-Counter Adjustable Cup Dispenser

- Smaller footprint than standard Sentry® dispenser
- Adjustable Lifetime Levers™ prevent marring of cups and provide one-at-a-time dispensing

ITEM	CUP RIM DIAMETER	APPROX. CUP SIZE	COUNTER HOLE DIAM.	TUBE LENGTH
C5250C	27/16" - 3⅝" (62-92 mm)	4-24 oz. (118-710 ml)	4⅝" (124 mm)	23½" (597 mm)
C5250C18	27/16" - 3⅝" (62-92 mm)	4-24 oz. (118-710 ml)	4⅝" (124 mm)	18" (457 mm)

Construction: High-impact plastic

Note: For multiple in-counter units leave a 6¼" (159 mm) space between each unit.



C5250C

One-Size-Fits-All EZ-Fit®

- Includes a gasket pack to handle wide range of cup sizes
- Easily change cup sizes without having to change dispenser
- Dispenses paper, plastic and foam cups one-at-a-time

ITEM	CUP RIM DIAMETER	APPROX. CUP SIZE	COUNTER HOLE DIAM.	TUBE LENGTH
C2410C	27/8" - 4¾" (73-121 mm)	8-46 oz. (236-1360 ml)	5¾" (146 mm)	23¼" (590 mm)
C2410C16	27/8" - 4¾" (73-121 mm)	8-46 oz. (236-1360 ml)	5¾" (146 mm)	16" (406 mm)
C2410C18	27/8" - 4¾" (73-121 mm)	8-46 oz. (236-1360 ml)	5¾" (146 mm)	18" (457 mm)
C2410CBK (BLACK GASKET)	27/8" - 4¾" (73-121 mm)	8-46 oz. (236-1360 ml)	5¾" (146 mm)	23¼" (590 mm)

Construction: High-impact plastic

Note: For multiple in-counter units leave a 7⅝" (181 mm) space between each unit.



C2410C



C2210C

Euro EZ-Fit®

- Smaller footprint than standard EZ-Fit® dispenser

ITEM	CUP RIM DIAMETER	APPROX. CUP SIZE	COUNTER HOLE DIAM.	TUBE LENGTH
C2210C	2 ⁷ / ₈ " - 3 ⁷ / ₈ " (73-98 mm)	6-24 oz. (178-710 ml)	4 ⁷ / ₈ " (124 mm)	23 ³ / ₄ " (590 mm)
C2210C18	2 ⁷ / ₈ " - 3 ⁷ / ₈ " (73-98 mm)	6-24 oz. (178-710 ml)	4 ⁷ / ₈ " (124 mm)	18" (457 mm)
C2210CBK <small>(BLACK GASKET)</small>	2 ⁷ / ₈ " - 3 ⁷ / ₈ " (73-98 mm)	6-24 oz. (178-710 ml)	4 ⁷ / ₈ " (124 mm)	23 ³ / ₄ " (590 mm)

Construction: High-impact resistant plastic

Note: For multiple in-counter units leave a 6¹/₄" (159 mm) space between each unit.



C2510C

Large Deli Cup EZ-Fit®

- Largest capacity EZ-Fit® dispenser

ITEM	CUP RIM DIAMETER	APPROX. CUP SIZE	COUNTER HOLE DIAM.	TUBE LENGTH
C2510C	4 ⁷ / ₈ " - 5 ⁵ / ₈ " (124-143 mm)	32-64 oz. (950-1890 ml)	6 ⁵ / ₈ " (168 mm)	22 ¹ / ₂ " (572 mm)

Construction: High-impact resistant plastic

Note: For multiple in-counter units leave a 8³/₄" (222 mm) space between each unit.



C2010C

Portion Cup EZ-Fit®

- Smallest capacity EZ-Fit® dispenser

ITEM	CUP RIM DIAMETER	APPROX. CUP SIZE	COUNTER HOLE DIAM.	TUBE LENGTH
C2010C	1 ¹ / ₂ " - 2 ⁵ / ₁₆ " (38-59 mm)	½-2½ oz. (15-70 ml)	3 ³ / ₄ " (83 mm)	16" (406 mm)

Construction: High-impact resistant plastic

Note: For multiple in-counter units leave a 4¹/₂" (114 mm) space between each unit.

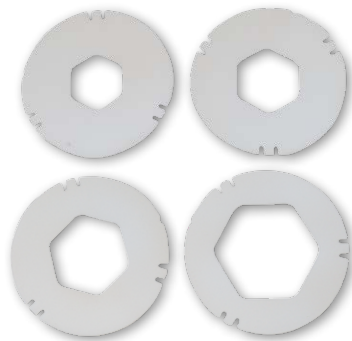

XC2426

EZ-Fit® Cup Dispenser Gaskets

- Rubber gaskets & plastic inserts for EZ-Fit cup dispensers

ITEM	DESCRIPTION	QUANTITY
XC2426	C2410C EZ-Fit Dispenser Gaskets	(Pack of 4 - S, M, L, XL)
XC2426BK	C2410C EZ-Fit Dispenser Black Gaskets	(Pack of 4 - S, M, L, XL)
XC2226	C2210C Euro EZ-Fit Dispenser Gaskets	(Pack of 4 - S, M, L, XL)
XC2226BK	C2210C Euro EZ-Fit Dispenser Black Gaskets	(Pack of 4 - S, M, L, XL)
XC2526	C2510C Deli Cup Dispenser Gaskets	(Pack of 3 - S, M, L)
XC2022	C2010C Portion Cup Dispenser Gaskets	(Pack of 4 - S, M, L, XL)
C2400350	C2410C EZ-Fit Dispenser 3.5" Fixed Rim Insert	1 each
C2400363	C2410C EZ-Fit Dispenser 3.625" Fixed Rim Insert	1 each
C2400368	C2410C EZ-Fit Dispenser 3.68" Fixed Rim Insert	1 each
C2400413	C2410C EZ-Fit Dispenser 4.125" Fixed Rim Insert	1 each
C2400450	C2410C EZ-Fit Dispenser 4.5" Fixed Rim Insert	1 each

Half sized gaskets also available upon request.

EZ-Fit® Metal Finish Rings

ITEM

C22XC

C24XC

DESCRIPTION

For C2210C (2 pk)

For C2410C (2 pk)



Sentry® Metal Finish Rings

ITEM

C52XC

C54XC

DESCRIPTION

For C5250C (2 pk)

For C5450C (2 pk)



Stainless Steel Counter-Mount Beverage Cup **NEW**

- Easily adjusts to a wide range of cup diameters
- Dispenses paper, plastic and foam cups one-at-a-time
- High-end image
- Durable stainless steel construction

ITEM	CUP RIM DIAMETER	APPROX. CUP SIZE	COUNTER HOLE DIAM.	TUBE LENGTH
C6200C	2½" - 3¼" (64-79 mm)	6-10 oz. (177-296 ml)	4¾" (106 mm)	23½" (597 mm)
C6400C	3" - 3¾" (76-98 mm)	12-24 oz. (355-710 ml)	4¾" (119 mm)	23½" (597 mm)
C6500C	4" - 4¾" (101-117 mm)	32-46 oz. (950-1360 ml)	5¾" (146 mm)	23½" (597 mm)

Construction: 26-gauge stainless steel



C6400C



SURFACE-MOUNT CUP

- Ideal for under counter, wall-mount, or end cap applications
- Can be mounted horizontally, vertically or at a 45° angle



C5450SM

Sentry® Surface-Mount Adjustable Cup Dispenser

- Adjustable Lifetime Levers™ prevent marring of cups
- Dispenses paper, plastic and foam cups one-at-a-time

ITEM	CUP RIM DIAMETER	APPROX. CUP SIZE	TUBE LENGTH
C5250SM	2 ⁷ / ₁₆ " - 3 ⁵ / ₈ " (62-92 mm)	4-24 oz. (118-710 ml)	18" (457 mm)
C5450SM	3 ¹ / ₈ " - 4 ¹ / ₂ " (79-114 mm)	8-44 oz. (236-1301 ml)	23 ³ / ₄ " (604 mm)

Construction: (Tube) high-impact plastic; (Wire Form) 6-gauge plated wire



COUNTER SERVICE



C2210SM

Surface-Mount EZ-Fit®

- Includes a gasket pack to handle a wide range of cup sizes
- Easily change cup sizes without having to change dispenser
- Dispenses paper, plastic and foam cups one-at-a-time

ITEM	CUP RIM DIAMETER	APPROX. CUP SIZE	TUBE LENGTH
C2210SM	2 ⁷ / ₈ " - 3 ⁷ / ₈ " (73-98 mm)	6-24 oz. (177-710 ml)	18" (457 mm)
C2410SM	2 ⁷ / ₈ " - 4 ³ / ₄ " (73-121 mm)	8-46 oz. (236-1360 ml)	23 ³ / ₄ " (590 mm)

Construction: (Tube) high-impact plastic; (Wire Form) 6-gauge plated wire



**HOW TO CHOOSE
MY STAINLESS STEEL
SURFACE-MOUNT
CUP DISPENSER**

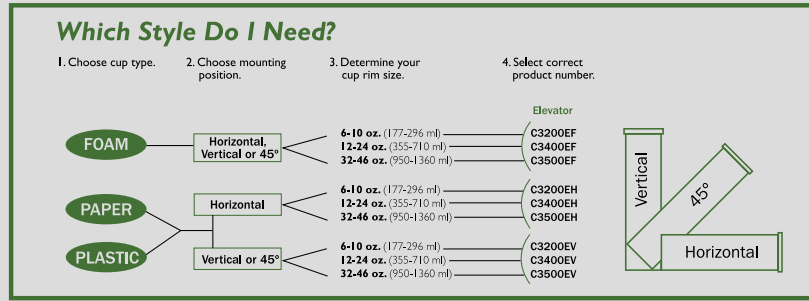

Stainless Steel Surface-Mount (Elevator) Beverage Cup

- Dispenses paper, plastic and foam cups one-at-a-time
- Durable stainless steel construction

ITEM	CUP RIM DIAMETER	APPROX. CUP SIZE	TUBE LENGTH
C3200EF C3200EH C3200EV	27/32" - 33/16" (56-81 mm)	6-10 oz. (177-300 ml)	233/4" (604 mm)
C3400EF C3400EH C3400EV	23/4" - 37/8" (70-98 mm)	12-24 oz. (350-710 ml)	233/4" (604 mm)
C3500EF C3500EH C3500EV	4" - 47/8" (101-124 mm)	32-46 oz. (950-1360 ml)	233/4" (604 mm)



Construction: 26-gauge stainless steel

Stainless Steel Pull-Type Beverage Cup

- Dispenses paper, plastic and foam cups one-at-a-time
- Durable stainless steel construction

ITEM	CUP RIM DIAMETER	APPROX. CUP SIZE	TUBE LENGTH
C3200P	27/32" - 33/16" (56-81 mm)	6-10 oz. (177-300 ml)	231/2" (597 mm)
C3400P	23/4" - 37/8" (70-98 mm)	12-24 oz. (350-710 ml)	231/2" (597 mm)
C3500P	4" - 47/8" (101-124 mm)	32-46 oz. (950-1360 ml)	231/2" (597 mm)



Construction: 26-gauge stainless steel

If your cup rim diameter is on the edge of two sizing options, please call our customer care at 1(800) 248-9826 Option 4 to ensure the right size is selected.



C4150SS C4160WH C4160TBL

Small Pull-Type Water Cup

ITEM	COLOR	CUP RIM DIAMETER	APPROX. CUP SIZE	TUBE LENGTH
CONSTRUCTION: 26-GAUGE STAINLESS STEEL				
C4150SS	SS	2¼"-2⅞" (57-73 mm)	Cone 3-4½ oz. (90-130 ml) Flat 3-5 oz. (90-150 ml)	16" (406 mm)
CONSTRUCTION: HIGH-IMPACT RESISTANT PLASTIC				
C4160*	WH, TBL	2¼"-2⅞" (57-73 mm)	Cone 3-4½ oz. (90-130 ml) Flat 3-5 oz. (90-150 ml)	16" (406 mm)



C4180CL C4180TBL C4180TBR

Small Pull-Type Water Cup with Throat

ITEM	COLOR	CUP RIM DIAMETER	APPROX. CUP SIZE	TUBE LENGTH
CONSTRUCTION: HIGH-IMPACT RESISTANT PLASTIC				
C4180*	TBR, TBL, TBLW, CL	2¼"-2⅞" (57-73 mm)	Cone 3-4½ oz. (90-130 ml) Flat 3-5 oz. (90-150 ml)	16" (406 mm)

Note: TBLW = Arctic Blue includes white flip cap to allow refilling without removing cap



C3165WH C3165FBL C3165TBL C3165BK

Medium Pull-Type Water Cup

ITEM	COLOR	CUP RIM DIAMETER	APPROX. CUP SIZE	TUBE LENGTH
CONSTRUCTION: HIGH-IMPACT RESISTANT PLASTIC				
C3165*	WH, TBL, FBL, BK	2½"-3¼" (64-83 mm)	Cone 4-10 oz. (120-300 ml) Flat 4-10 oz. (120-300 ml)	16" (406 mm)
C3165TBL20	TBL	2½"-3¼" (64-83 mm)	Cone 4-10 oz. (120-300 ml) Flat 4-10 oz. (120-300 ml)	20" (508 mm)

Includes flip cap to allow refilling without removing cap



C3450SS C3260TBR C3260TBL

Large Pull-Type Water Cup

ITEM	COLOR	CUP RIM DIAMETER	APPROX. CUP SIZE	TUBE LENGTH
CONSTRUCTION: 26-GAUGE STAINLESS STEEL				
C3250SS	SS	2¾"-3⅝" (70-86 mm)	Cone 4½-7 oz. (130-210 ml) Flat 6-12 oz. (180-350 ml)	16" (406 mm)
C3450SS	SS	3¼"-3⅞" (82-98 mm)	Cone 8-12 oz. (240-350 ml) Flat 12-24 oz. (350-710 ml)	16" (406 mm)
CONSTRUCTION: HIGH-IMPACT RESISTANT PLASTIC				
C3260*	TBR, TBL	2¾"-3⅝" (70-86 mm)	Cone 4½-7 oz. (130-210 ml) Flat 6-12 oz. (180-350 ml)	16" (406 mm)

Pull-Type Foam Beverage Cup

ITEM	COLOR	CUP RIM DIAMETER	APPROX. CUP SIZE	TUBE LENGTH
CONSTRUCTION: HIGH-IMPACT POLYETHYLENE				
C4210PFSD	SD	2¾"-3¾" (70-85 mm)	4-10 oz. (120-300 ml)	23½" (597 mm)
C4410PFSD	SD	3¼"-3¾" (82-98 mm)	12-24 oz. (350-710 ml)	23½" (597 mm)
CONSTRUCTION: 26-GAUGE STAINLESS STEEL				
C4200PF	SS	2¾"-3¾" (70-85 mm)	4-10 oz. (120-300 ml)	23½" (597 mm)
C4400PF	SS	3¼"-3¾" (82-98 mm)	12-24 oz. (350-710 ml)	23½" (597 mm)
C4500PF	SS	3¾"-4¾" (98-124 mm)	32-46 oz. (950-1360 ml)	23½" (597 mm)



C4210PFSD C4400PF

Pull-Type Paper/Plastic Beverage Cup

ITEM	COLOR	CUP RIM DIAMETER	APPROX. CUP SIZE	TUBE LENGTH
CONSTRUCTION: HIGH IMPACT RESISTANT POLYETHYLENE				
C4210PRD	RD	2½"-3¼" (64-83 mm)	4-10 oz. (120-300 ml)	23½" (597 mm)
C4410PRD	RD	3¾"-3¾" (85-98 mm)	12-24 oz. (350-710 ml)	23½" (597 mm)



C4210PRD

Adjustable Portion Cup Dispensers

ITEM	COLOR	CUP RIM DIAMETER	APPROX. CUP SIZE	TUBE LENGTH
CONSTRUCTION: HIGH-IMPACT WHITE POLYETHYLENE				
C3000EWH	WH	1¾"-2½" (44-64 mm)	1¾"-4½" oz. (50-130 ml)	16" (406 mm)
CONSTRUCTION: 26-GAUGE STAINLESS STEEL				
C3000PSS	SS	1¾"-2½" (44-64 mm)	1¾"-4½" oz. (50-130 ml)	16" (406 mm)



C3000EWH C3000PSS

Ice Cream Cone Dispenser

- Easily mounts onto any wall surface
- Includes (3) easy-to-change gaskets for cake, sugar or waffle cones
- Keeps cones fresh and protected from breaking

ITEM	DIMENSIONS
IC2200SM	30¾"-6" (772-152 mm)

Construction: High-impact plastic

* Specify desired color after item number. Example: C4160TBL



Arctic Blue Bronze Clear Frosted Blue Red Stainless Steel White Sand Black



LID & STRAW

- Save money by reducing waste with San Jamar's dispensers
- The EZ-Fit® lid dispenser dispenses cold beverage lids one-at-a-time



L2204

Lid Towers

- High capacity lid and straw organization
- Countertop design allows you to move organizer and accommodate changing needs

ITEM	INCLUDES	DIMENSIONS
L2202	(2) lid compartments (1) straw compartment	18¾"H x 5½"W x 13"D (476 x 140 x 330 mm)
L2203	(3) lid compartments (1) straw compartment	24½"H x 5½"W x 13"D (622 x 140 x 330 mm)
L2204	(4) lid compartments (1) straw compartment	30"H x 5½"W x 13"D (762 x 140 x 330 mm)

Construction: Black polystyrene



L2400C

EZ-Fit® In-Counter Lid Dispensers*

- Provides simple, sanitary dispensing of most flat cold-beverage lids
- One-handed operation is easy to use
- Front loading; requires no adjustment

ITEM	LID RIM DIAMETER	APPROX. CUP SIZE	COUNTER HOLE DIAMETER	TUBE LENGTH
L2200C	2¾" - 3¾" (70-95 mm)	8-24 oz. (236-710 ml)	4⅞" (124 mm)	23¾" (603 mm)
L2400C	3¾" - 4½" (95-114 mm)	24-46 oz. (710-1360 ml)	5¾" (146 mm)	23¾" (603 mm)

Construction: Impact resistant plastic



COUNTER SERVICE



L2912BK

L2913BK

EZ-Fit® Lid Dispenser Cabinets*

- Durable and attractive countertop lid dispensers
- Available in 1, 2 and 3-compartment cabinets; two lid dispenser sizes to accommodate most sizes of lids
- Simple design has few parts and requires no adjustment

ITEM	INCLUDES	DIMENSIONS
L2910BK	(1) L2200C; black trim ring	7¾"H x 7¾"W x 25⅝"D (197 x 197 x 646 mm)
L2920BK	(1) L2400C; black trim ring	7¾"H x 7¾"W x 25⅝"D (197 x 197 x 646 mm)
L2912BK	(1) L2200C, (1) L2400C; black trim rings	15½"H x 7¾"W x 25⅝"D (384 x 197 x 646 mm)
L2913BK	(2) L2200C, (1) L2400C; black trim rings	22⅝"H x 7¾"W x 25⅝"D (568 x 197 x 646 mm)
L2923BK	(1) L2200C, (2) L2400C; black trim rings	22⅝"H x 7¾"W x 25⅝"D (568 x 197 x 646 mm)
L2913BK	(2) L2200C, (1) L2400C; black trim rings	22⅝"H x 7¾"W x 25⅝"D (568 x 197 x 646 mm)

Construction: Black polystyrene



* EZ-Fit® Lid Dispensers are intended for use with flat, cold beverage lids only. May not be compatible with all lid types. To confirm lid compatibility, please provide a full sleeve of lids prior to ordering.

Bulk Straw Dispensers

- High capacity straw organization
- Removable lid and tray for easy cleaning

ITEM	DESCRIPTION	DIMENSIONS
ST500	Double-sided straw dispenser - 500 count	8"H x 10"W x 7 ⁷ / ₈ "D (203 x 254 x 200 mm)
ST250	Single-sided straw dispenser - 250 count	8"H x 10"W x 4 ³ / ₄ "D (203 x 254 x 108 mm)
ST250WM	Wall mounting bracket for use with ST250	6 ³ / ₄ "H x 10 ³ / ₄ "W x 5"D (171 x 273 x 127 mm)



Modular Straw & Napkin **NEW** Combo Dispensers

- Two-in-one, over-under design reduces footprint & saves space
- Interchangeable lower dispensers to increase utility
- Smooth one-at-a-time napkin dispensing to reduce napkin waste
- Easy access to straws or condiments

ITEM	DESCRIPTION	NAPKIN TYPE	DIMENSIONS
MODH6003SN	Straw and Napkin Dispenser	Interfold	22.15"H x 9.40"W x 13.63"D (563 x 239 x 346 mm)
MODH60030GN	Organizer and Napkin Dispenser	Interfold	22.15"H x 9.40"W x 13.63"D (563 x 239 x 346 mm)
MODH6005SN	Straw and Napkin Dispenser	Fullfold	22.15"H x 9.40"W x 13.68"D (563 x 239 x 347 mm)
MODH60050GN	Organizer and Napkin Dispenser	Fullfold	22.15"H x 9.40"W x 13.68"D (563 x 239 x 347 mm)



Straw Dispenser

- In-counter dispenser organizes straws and stirrers utilizing simple mounting ring to lock secure holder

ITEM	STRAW RIM DIAMETER	COUNTER HOLE DIAMETER	TUBE LENGTH
L320C	5 ³ / ₈ " (136 mm)	4 ³ / ₁₆ " (106 mm)	6" (152 mm)

Construction: 22-gauge stainless steel

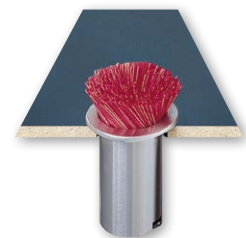



Wall-Mount Lid Dispensers

- Designed to keep your lids clean and organized
- Available in single and double lid designs
- Front-loading provides easy and smooth access to lids
- Brackets allow for either wall or dispenser stand mounting

ITEM	CAPACITY	MAX LID RIM DIAMETER	APPROX. CUP SIZE	TUBE LENGTH
L3200	1 sleeve	3½" (89 mm)	6-10 oz. (180-300 ml)	23½" (597 mm)
L3400	1 sleeve	4" (101 mm)	12-24 oz. (350-710 ml)	23½" (597 mm)
L3500	1 sleeve	5" (127 mm)	24-46 oz. (710-1360 ml)	23½" (597 mm)
L3402 (double lid)	1 sleeve	4" (101 mm)	12-24 oz. (350-710 ml)	23½" (597 mm)
L3502 (double lid)	1 sleeve	5" (127 mm)	24-46 oz. (710-1360 ml)	23½" (597 mm)

Construction: 22-gauge stainless steel

Adjustable Lid Dispenser/Organizer

- Can be placed on a countertop or wall mounted
- Adjustable compartments adapt to the lid size being dispensed
- Comes with straw caddy (L1035) that can attach to either side



ITEM	CAPACITY	DIMENSIONS
L1014	3 stacks	6½"H x 17½"W x 5½"D (165 x 435 x 130 mm)
L1022	5 stacks	6½"H x 25¼"W x 5½"D (165 x 641 x 130 mm)

Construction: (Lid organizers) 22-gauge stainless steel; (Stirrer & straw caddy) high-impact plastic



PCL3ADJ



PCL2

Portion Cup & Lid Organizer **NEW**

- Removable dividers for easy cleaning
- Non-slip rubber feet
- Dishwasher safe
- Adjustable unit (PCL3ADJ) accommodates two or three inch cups and lids

ITEM	LID/CUP RIM DIAMETER	DIMENSIONS
PCL2	2" (50.8 mm)	10"H x 11½"W x 3¼"D (250 x 290 x 82 mm)
PCL3ADJ	2-3" (50.8-76.2 mm)	10"H x 11½"W x 3¾"D (250 x 290 x 95 mm)



COUNTERTOP ORGANIZERS

COUNTERTOP ORGANIZERS

- Efficiently use valuable countertop space for dispensable items
- Provide sanitary, easy access to condiments





Modular Organizer **NEW**

- Interchangeable trays
- Removable dividers
- Makes contents easily accessible and visible

ITEM	DESCRIPTION	DIMENSIONS
MODL2900KIT	(1) Base unit, (2) shallow trays, (1) deep tray, (4) rubber linking feet	12.5"H x 18.72"W x 18.75"D (318 x 475 x 473 mm)
MODL29001	Shallow tray: includes (3) dividers	2.75"H x 5.83"W x 17"D (69 x 148 x 432 mm)
MODL29002	Deep tray: includes (1) divider	6.22"H x 5.83"W x 17"D (158 x 148 x 432 mm)

Construction: High-impact plastic





MODBD2002KIT

Modular Mini Dome® Series **NEW**

- Accommodates four Mini Domes
- Can be used for dry or chilled condiments
- Domed lids for higher capacity
- Interlocks with other Modular units

ITEM	DESCRIPTION	DIMENSIONS
MODBD2002KIT	(1) Base unit, (1) Mini Dome insert, (4) BD2002, (4) rubber linking feet	12.5"H x 18.72"W x 18.75"D (318 x 475 x 473 mm)
MODBD2002	Base unit, (1) Mini Dome insert, (4) rubber linking feet	12.5"H x 18.72"W x 18.75"D (318 x 475 x 473 mm)
MODBD20021	Mini Dome insert	6.05"H x 18.61"W x 16.88"D (154 x 473 x 429 mm)

Construction: High-impact plastic
See page 110 for BD2002 product details.



MODMP16KIT

Modular ModPan™ Series **NEW**

- Accommodates four 1/6 GN size pans
- Excellent for high capacity garnish storage
- Interlocks with other Modular units
- Fits Carlisle StorPlus™ & Coldmaster® food pans

ITEM	DESCRIPTION	DIMENSIONS
MODMP16KIT	(1) Base unit, (1) ModPan insert, (4) MP16, (4) rubber linking feet	12.5"H x 18.72"W x 18.75"D (318 x 475 x 473 mm)
MODMP16	Base unit, (1) ModPan insert, (4) rubber linking feet	12.5"H x 18.72"W x 18.75"D (318 x 475 x 473 mm)
MODMP161	ModPan insert	1.25"H x 18.61"W x 16.88"D (32 x 473 x 429 mm)

Construction: High-impact plastic
See page 115 for MP16 product details.



Modular Bulk FIFO Dispenser **NEW**

- Top loading, bottom dispensing for first-in, first-out use
- Removable divider to allow horizontal plastic flatware dispensing
- High capacity condiment dispensing to reduce labor spent refilling

ITEM	DESCRIPTION	DIMENSIONS
MODBFD	Modular bulk first-in, first-out dispenser	16.57"H x 8.92"W x 12.06"D (421 x 227 x 306 mm)

Construction: High-impact plastic



Modular FrontLine™ Pump & Accessories **NEW**

- Dispenses from gallon jar, #10 can, Cryovac® bag and direct pour
- Portion Cup & Lid Dispensers use EZ-Fit Technology to dispense one-at-a-time
- Soft-Touch™ Pump delivers smooth, effortless dispensing
- Attachable drip tray keeps excess sauce off the countertop

ITEM	DESCRIPTION	DIMENSIONS
MODP4900CL	Includes: P4900, MODCL100, MODBASE, MODTRAY	23"H x 14.01"W x 11.35"D (584 x 356 x 288 mm)
MODP4900CC	Includes: P4900, MODCC100, MODBASE, MODTRAY	23"H x 14.01"W x 11.35"D (584 x 356 x 288 mm)
MODCL100*	Modular Portion Cup & Lid Dispenser	14.42"H x 6.01"W x 11.25"D (366 x 153 x 286 mm)
MODCC100	Modular Portion Cup Dispenser	12.59"H x 6.01"W x 11.25"D (320 x 153 x 286 mm)
MODBASE	Modular FrontLine Pump Base	7.83"H x 8"W x 11.35"D (187 x 203 x 288 mm)
MODTRAY	Modular FrontLine Pump Drip Tray	1.32"H x 7.02"W x 9.11"D (34 x 178 x 231 mm)



MODP4900CC



MODCL100

MODCC100 & MODCL100 include a 4 pack of gaskets for each cup unit to handle a wide range of cup sizes

*Portion Cup & Lid Dispensers are designed to work with cups and lids measuring 1.5" - 2.31" (38-59 mm) in rim diameter.

See page 121 for P4900 product details.

Cryovac® is a registered trademark of Cryovac, Inc., a subsidiary of Sealed Air Corporation

Construction: High-impact plastic.



Modular Straw & Napkin **NEW** Combo Dispensers

- Two-in-one, over-under design reduces footprint & saves space
- Interchangeable lower dispensers to increase utility
- Smooth one-at-a-time napkin dispensing to reduce napkin waste
- Easy access to straws or condiments

ITEM	DESCRIPTION	NAPKIN TYPE	DIMENSIONS
MODH6003SN	Straw and Napkin Dispenser	Interfold	22.15"H x 9.40"W x 13.63"D (563 x 239 x 346 mm)
MODH60030GN	Organizer and Napkin Dispenser	Interfold	22.15"H x 9.40"W x 13.63"D (563 x 239 x 346 mm)
MODH6005SN	Straw and Napkin Dispenser	Fullfold	22.15"H x 9.40"W x 13.68"D (563 x 239 x 347 mm)
MODH60050GN	Organizer and Napkin Dispenser	Fullfold	22.15"H x 9.40"W x 13.68"D (563 x 239 x 347 mm)



MODH60050GN



MODH6003SN



COUNTER SERVICE



MODGH100 shown with MODL2900KIT (MODL2900KIT sold separately)

Modular Graphics Holder **NEW**

- Identify contents for Modular Countertop Organizers
- Display in-house promotions

ITEM	DESCRIPTION	DIMENSIONS
MODGH100	Graphics and Promotion holder for MODL2900KIT, MODBD2002KIT, MODMP16KIT	4¼"H x 17"W (432 x 107 mm)



Venue® Coffee Sleeve Dispenser **NEW**

- Provides fast and easy dispensing of coffee sleeves
- Can be wall-mounted for drive-through or sit on countertop
- One-handed operation is easy to use

ITEM	DESCRIPTION	DIMENSIONS
CSD100	For use with sleeves up to 2½"H x 4¾"W	5¼"H x 5¾"W x 14¾"D (133 x 146 x 375 mm)



L2100

Lid Organizers

- Keep lids organized and easily accessible to customers
- Countertop design allows you to move organizer to accommodate changing needs

ITEM	DIMENSIONS
L2100	11"H x 12½"W x 16½"D (279 x 318 x 419 mm)
L2150	10¾"H x 8½"W x 16½"D (273 x 216 x 419 mm)

Construction: 22-gauge 304-stainless with impact resistant plastic tray

Condiment & Straw Organizer

ITEM

L2900

Construction: Black polystyrene

DIMENSIONS

9½"H x 8¾"W x 25¾"D (241 x 208 x 637 mm)



Large Trash Chute

ITEM

L360C

Construction: 22-gauge stainless steel

DIAMETER

6¾" (168 mm)

COUNTER HOLE DIAMETER

6" (152 mm)

TUBE LENGTH

5¼" (133 mm)



TRAYS

TRAYS

- Made from 70% renewable materials
- Textured wood look provides natural feel





ETW4232WW



ETW4222LW



ETW4636GW

Earth Tray™ **NEW**

- Dishwasher safe
- Ergonomically shaped
- Made from 70% renewable material

ITEM	COLOR	DIMENSIONS	CASE
ETW4222*	LW, GW, WW	16½"W x 8½"L (42 x 22 mm)	25
ETW4232*	LW, GW, WW	16½"W x 12½"L (42 x 32 mm)	25
ETW4636*	LW, GW, WW	18"W x 14"L (46 x 36 mm)	25



*Specify desired color after each part number. Example: ETW4232LW



Light Wood



Gray Wood



Warm Wood

FOOD SAFETY TOOLS

Cross-contamination is a danger to any foodservice operation.

San Jamar's innovative food safety tools promote safe food handling, sanitation, and more importantly, keep operations thriving and protected from food safety risks.

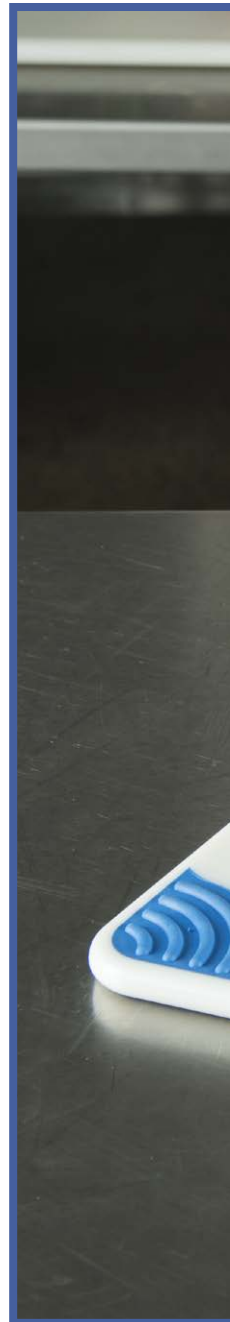

**ALLERGEN
SAFETY**

**SAFE ICE
HANDLING**



**SAFE FOOD
PREPARATION**

**SANITATION
TOOLS**

**CUTTING
BOARDS**

ALLERGEN SAFETY



**AS MANY AS
15 MILLION
AMERICANS
HAVE FOOD
ALLERGIES**

- San Jamar's purple color helps to safeguard your business by alerting staff to follow special food allergy procedures in the kitchen



CBMASZ2430

CBMASZ1212

Allergen Saf-T-Zone™ Mats

- Easily identify allergen preparation is being done
- Top 8 allergens are identified on the mat to aid in employee allergen awareness
- Purple text for easy identification of an allergen zone

ITEM	INCLUDES
CBMASZ1212	Server window Allergen Saf-T-Zone™ Mat 12" x 12" (304 x 304 mm)
CBMASZ2430	Prep station Allergen Saf-T-Zone™ Mat 24" x 30" (609 x 762 mm)

California Residents: Styrene
WARNING (See Appendix C on page 183)





STK1006

*Knives not included

Allergen Saf-T-Knife® Station Jr.*

- Purple color-coded lid quickly identifies knives that are used to prepare allergen-free meals
- Sanitary, safe and secure storage for kitchen knives
- Perfect size for prep lines and smaller kitchens
- Easy to assemble and clean

ITEM	DESCRIPTION	DIMENSIONS
STK1006	Saf-T-Knife® Station Jr.	14½"H x 8¾"W x 4"D (368 x 211 x 102 mm)
STK1006PRL	Saf-T-Knife® Station Jr. - Purple (Lid Only)	17⅝"H x 8"W x 4"D (48 x 203 x 102 mm)



FOOD SAFETY TOOLS



ASZ121812SYS

Allergen Saf-T-Zone™ System

- Purple color alerts staff to follow special food allergy procedures
- Includes commercial-grade cutting board, tongs, turner and Chef's knife
- Durable purple case is easy to find in the kitchen and securely protects tools and board

ITEM	INCLUDES
ASZ121812SYS	(1) Saf-T-Grip® purple cutting board (CBG121812PR) 12" x 18" x ½" (305 x 457 x 13 mm) (1) Stainless steel chef knife with purple handle 10" (254 mm) (1) Stainless steel tongs with purple handle 12" (305 mm) (1) Stainless steel turner with purple handle 13" (330 mm) (Thermometer not included)
ASZTHERMW	Professional digital thermometer with protective sheath, dishwasher safe



Allergen Saf-T-Zone™
Cutting Board
CBG121812PR



12" Tongs
ASZTONGS



13" Turner
ASZTURNER



10" Chef
Knife
ASZKNIFE



Thermometer sold separately

ASZTHERMW



Allergen Kleen-Pail® **NEW**

- Color-coded purple pail identifies the difference between sanitation buckets
- Sanitize allergen preparation surfaces to minimize the risk of cross-contamination
- Trilingual label aids in training

ITEM	COLOR	DESCRIPTION
KP196PR	Purple	6 quart (5.68 L)



Allergen ModPan™ Lids **NEW**

- Purple color-coded lids designed to keep track of allergenic ingredients
- Perfect size for prep lines and smaller kitchens
- Easy to assemble, clean and store

ITEM	DESCRIPTION	QUANTITY
MPL19PR	¾ lid only	6
MPL16PR	¾ lid only	6
MPL14PR	¾ lid only	6
MPL13PR	¾ lid only	6
MPL12PR	¾ lid only	6



MPL19PR

See page 115 for ModPans

Construction: Polypropylene



FOOD SAFETY TOOLS



SCDGLPPLTPR

SCDG11PLTPR

Allergen Scale Platforms **NEW**

- Purple scale platforms designed to keep track of allergenic ingredients

ITEM	COMPATIBILITY	DIMENSIONS
SCDGLPPLTPR	Fits SCDG2LP, SCDG13LP	5.75"L x 5.75"W (146 x 146 mm)
SCDG11PLTPR	Fits SCDGP11, SCDG11	5.5"L x 5.5"W (140 x 140 mm)

See page 138 for scales.



Allergen Sparta® Spectrum® Cutting Board Brush **NEW**

- Purple color alerts staff to follow special procedures
- Ergonomic handles provide comfortable grip

ITEM	DESCRIPTION	DIMENSIONS
CBB6PR	4-pack	6"L x 2"W (152 x 50.8 mm) Bristle Length: 1.38" (35 mm)

Allergen Saf-T-Zone™ Cutting Boards

- Purple color alerts staff to follow special procedures
- Durable co-polymer material will not warp
- Integrated anti-slip grip securely holds board in place

ITEM

CBG6938PR

CBG912PR

CBG121812PR

CBG152012PR

DIMENSIONS

6"H x 9"W x 3/8"D (152 x 229 x 9.5 mm)

9"H x 12"W x 3/8"D (229 x 305 x 9.5 mm)

12"H x 18"W x 1/2"D (305 x 457 x 13 mm)

15"H x 20"W x 1/2"D (381 x 508 x 13 mm)



Allergen Cut-Resistant Glove with Dyneema®

WITH EXCLUSIVE DOUBLE GUARD™ ANTIMICROBIAL AGENT

- 10 gauge Dyneema fiber
- Ambidextrous, lightweight and machine washable
- ANSI Level A7 cut protection

ITEM	COLOR	SIZE	LENGTH	MATERIAL	CUT PROTECTION
SG10-PR*	Purple (PR)	S, M, L	11" (279 mm)	Dyneema*** composite yarn	Meets OSHA standard (29 CFR) 1910.132 - Tested in accordance with ASTM Spec 177.20



* Specify desired size after item number. Example: SG10-PR-S

*** Dyneema® is a registered trademark of Royal DSM N.V. Under license of Double D Knitting & Glove, Inc.



SAFE ICE HANDLING

TOTES

SCOOPS & HOLDERS

TOTES

- The original dedicated Saf-T-Ice® Tote is designed to make ice transport easier and safer than traditional “buckets”
- Unique patented features and accessories





SI6100

SI6000

Original & Shorty™ Saf-T-Ice® Tote

- Dedicated container for safe ice transport
- HACCP Hanger™ reduces back strain and injuries
- Tri-grip™ design for easier, more controlled handling

ITEM	DESCRIPTION	CAPACITY
SI6000	Original Saf-T-Ice® Tote	6 gallons (22.7 L)
SI6100	Shorty™ Saf-T-Ice® Tote	5 gallons (18.9 L)
ACCESSORIES		
SI6500	Saf-T-Ice® Lid (Fits both SI6000 and SI6100)	

California Residents: Bisphenol A
WARNING (See Appendix A on page 183)



Saf-T-Ice® Cart

- Cart transport system for use with (2) Saf-T-Ice® SI6000 or (2) SI6100
- Avoid costly work injuries; doubles productivity
- Folds for easy storage

ITEM	DESCRIPTION
SICART60	Cart transportation system for use with (2) SI6000 Saf-T-Ice® Totes (Totes sold separately)
SICART61	Cart transportation system for use with (2) SI6100 Saf-T-Ice® Totes (Totes sold separately)



SICART60



FOOD SAFETY TOOLS



Saf-T-Ice® Value Pack

- The complete solution for preventing ice contamination at the ice machine
- Saf-T-Scoop® protects ice from hand contact and directs ice right into Saf-T-Ice® Tote, minimizing dangerous ice spills

ITEM	DESCRIPTION
SI8500	SI6000 Tote & 64-86 oz. (1.9-2.5 L) Saf-T-Scoop® and Guardian™ System (1 each)

California Residents: Bisphenol A
WARNING (See Appendix A on page 183)



BPA Free Saf-T-Ice® Tote **NEW**

- Dedicated container for safe ice transport
- HACCP Hanger™ reduces back strain and injuries
- Constructed with polypropylene material

ITEM	DESCRIPTION	CAPACITY
SI6000BPAF	BPA Free Original Saf-T-Ice® Tote	6 gallons (22.7 L)



Saf-T-Ice® Lid

- Fits both Original & Shorty™ Totes
- For sanitary & secure transport of ice

ITEM	DESCRIPTION
SI6500	Fits SI6000, SI6000BPAF & SI6100



Light Duty Ice Tote

- Economical, easy and safe way to transport ice
- Attaches to ice bin for faster and easier filling
- Dual-grip design provides secure handling options for improved ergonomics

ITEM	DESCRIPTION	CAPACITY
SILD6000	Light Duty Ice Tote	6 gallons (22.7 L)



Banquet/Beverage Saf-T-Scoop®

- Germ-Guards™ protect ice from contact with hands
- Drain holes prevent watering down of beverages
- Built in hook prevents cross-contamination; stores neatly on side of bin

ITEM	DESCRIPTION
SI4550	Saf-T-Scoop® 4-6 oz. (118-177 ml) (scoop only)

California Residents: Bisphenol A
WARNING (See Appendix A on page 183)



Saf-T-Ice® Scoop Caddy

- Works with ice scoops up to 86 ounces
- Durable construction; dishwasher safe
- Flexible mounting options

ITEM	COLOR	DIMENSIONS
SI2000	Blue	11 ³ / ₁₆ "H x 9 ³ / ₈ "W x 8"D (287 x 231 x 204 mm)
SI2000BK	Black	11 ³ / ₁₆ "H x 9 ³ / ₈ "W x 8"D (287 x 231 x 204 mm)





SI5000

Saf-T-Scoop® & Guardian™ System for Bar & Beverage Stations

- Germ-Guards™ protect ice from contact with hands
- Guardian™ provides safe, dedicated scoop storage
- Flexible mounting options

ITEM	DESCRIPTION
INCLUDED MOUNTING TOOLS: (1) MOUNTING BRACKET, (2) WIRE HANGING BRACKETS AND (2) SUCTION CUPS	
SI5000	Saf-T-Scoop & Guardian System 6-10 oz. (177-295 ml) (1) Saf-T-Scoop®, (1) Guardian holder with removable drainage cap, (1) set mounting tools
SI5500	Saf-T-Scoop 6-10 oz. (177-295 ml) (scoop only)
SI7000	Saf-T-Scoop & Guardian System 12-16 oz. (355-473 ml) (1) Saf-T-Scoop®, (1) Guardian holder with removable drainage cap, (1) set mounting tools
SI7500	Saf-T-Scoop 12-16 oz. (355-473 ml) (scoop only)
SI7700	Saf-T-Scoop & Guardian System 20-24 oz. (591-710 ml) (1) Saf-T-Scoop®, (1) Guardian holder with removable drainage cap, (1) set mounting tools
SI7750	Saf-T-Scoop 20-24 oz. (591-710 ml) (scoop only)

California Residents: Bisphenol A

WARNING (See Appendix A on page 183)



SI7850

Adjustable Saf-T-Scoop® & Guardian™ System for Iced Beverages

- Designed for iced drink applications and beverage stations
- Eliminate multiple sizes of scoops
- Dispenses 8 oz., 16 oz. and 24 oz. of ice to multiple sizes of cups

ITEM	DESCRIPTION
SI7800	Adjustable Saf-T-Scoop & Guardian System 8-24 oz. (263.6-709.8 mL) (1) Adjustable Saf-T-Scoop®, (1) Guardian holder with removable drainage cap, (1) set mounting tools
SI7850	Adjustable Saf-T-Scoop® 8-24 oz. (263.6-709.8 mL) (Scoop only)





Saf-T-Scoop® & Guardian™ System for Ice Machines

- Germ-Guards™ protect ice from contact with hands
- Guardian™ provides safe, dedicated scoop storage
- Flexible mounting options

ITEM	DESCRIPTION
INCLUDED MOUNTING TOOLS: (1) MOUNTING BRACKET, (2) WIRE HANGING BRACKETS AND (2) SUCTION CUPS	
SI9000	Saf-T-Scoop & Guardian System 64-86 oz. (1.9-2.5 L) (1) Saf-T-Scoop®, (1) Guardian holder with removable drainage cap, (1) set mounting tools
SI9500	Saf-T-Scoop® 64-86 oz. (1.9-2.5 L) (scoop only)

California Residents: Bisphenol A
WARNING (See Appendix A on page 183)



Saf-T-Scoop® Alarm Monitoring System **NEW**

- Alarm prevents prolonged scoop displacement
- Adjustable sound levels
- Dual Germ-Guards™ protect against contamination

ITEM	DESCRIPTION
SI9000SAM	Saf-T-Scoop & Guardian System 64-86 oz. (1.9-2.5 L) (1) Alarm Module, (1) Saf-T-Scoop®, (1) Guardian holder with removable drainage cap, (1) set mounting tools

Alarm only works with SI9000SAM

California Residents: Bisphenol A
WARNING (See Appendix A on page 183)



FOOD SAFETY TOOLS

SAFE FOOD PREPARATION

COLD PADDLES

COLD SERVE

SAFE PREP

COLD PADDLES

- Harmful bacteria grows most rapidly in food at temperatures between 135°F (57°C) and 41°F (5°C)
- Rapi-Kool® cold paddles chill soups and stews quickly and safely from the “inside-out” with special cooling fins that provide maximum surface area for faster chilling





Rapi-Kool® Plus Cold Paddles

- Wide opening allows for on-demand use by filling with ice and water
- Patented Fill-Rite™ design eliminates over-filling when pre-freezing
- Integrated hanging hook for sanitary and secure storage

ITEM	DESCRIPTION
RCU64V2	64 oz. (1.9 L)
RCU64V2RD	Retail Package 64 oz. (1.9 L) Unit fully assembled, in clear bag with hang tag
RCU128V2	128 oz. (3.8 L)
RCU128V2RD	Retail Package 128 oz. (3.8 L) Unit fully assembled, in clear bag with hang tag

California Residents: Bisphenol A
WARNING (See Appendix A on page 183)



FOOD SAFETY TOOLS



RCU256

RCU64

RCU128

Rapi-Kool® Cold Paddles

- Chills food from the "inside-out" – for fast, even cooling
- Unique fin design increases surface area to cool foods quickly
- Constructed of durable food-safe plastic; dishwasher safe

ITEM	CAPACITY
RCU64	64 oz. (1.9 L)
RCU128	128 oz. (3.8 L)
RCU256	256 oz. (7.6 L)



California Residents: Bisphenol A
WARNING (See Appendix A on page 183)



RCU1282

Rapi-Kool® 2-Pack

- Handy 2-Pack ensures a back-up cold paddle is available for use
- Includes (2) extra caps

ITEM	CAPACITY
RCU642	64 oz. (1.9 L)
RCU1282	128 oz. (3.8 L)



California Residents: Bisphenol A
WARNING (See Appendix A on page 183)



RCUBRKT



RCUCAPPK

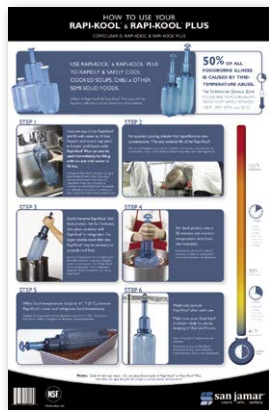

RCUWLCT

Rapi-Kool® Accessories

- Wall chart provides step-by-step English and Spanish instructions
- Replacement caps are available to fit any size of Rapi-Kool® cold paddle
- Hanging brackets free up valuable freezer shelf space, holding Rapi-Kool® securely

ITEM	DESCRIPTION
RCUCAPPK	Replacement Caps (4pk)
RCUWLCT	Wall Chart
RCUBRKT	Hanging Brackets (2pk)

COLD SERVE

Chill-It® Food Pans

- Portable cold-holding food pans with freezable non-toxic gel lining
- Freeze ahead for up to 8 hours of use
- Optional lids allow for stackable storage

ITEM	COLOR	CAPACITY
CI7001*	WH, BK	1/6 Pan: 52 oz. (1.5 L)
CI7002*	WH, BK	1/3 Pan Divided: 135 oz. (3.9 L)
CI7003*	WH, BK	1/3 Pan: 135 oz. (3.9 L)
CI7004*	WH, BK	1/2 Pan: 252 oz. (7.3 L)



Chill-It® Food Pan Lids

ITEM	FITS	LID TYPE
CI7111L	1/6 Pan: 52 oz. (1.5 L)	Standard
CI7113L	1/3 Pan Divided: 135 oz. (3.9 L)	Standard
CI7114L	1/2 Pan: 252 oz. (7.3 L)	Standard
CI7111NL	1/6 Pan: 52 oz. (1.5 L)	Notched



Bagged with header card

California Residents: Bisphenol A

WARNING (See Appendix A on page 183)

Chill-It® Crocks & Lids

- Versatile crocks can be used with optional lids and pumps
- Perfect for sauces and condiments that require chilling

ITEM	COLOR	DESCRIPTION
CI7015*	WH, BK	2 qt. Crock
CI7016H	Clear	Clear Lid
CI7016NL	Clear	Notched Lid
CI7016P	Clear	Pump Lid



California Residents: Bisphenol A

WARNING (See Appendix A on page 183)

Chill-It® Pitcher

- Keeps beverages and other liquids icy cold
- Protects batters, sauces & other liquids from time-temperature abuse
- Freezes in just 3 hours

ITEM	CAPACITY
CI7025	60 fl. oz. (1.8 L)



* Specify desired color after item number. Example: CI7001WH



White



Black

SAFE PREP

- Tools designed to create a safe food prep environment
- Minimize cross-contamination, manage food allergies and protect your customers and staff



SW1218SC



Saf-T-Wrap® Station

- Saves money by reducing labeling time and minimizing food waste by aiding in FIFO food rotation
- Dispenses dating labels in multiple sizes and configurations
- Available with safety blade for film, foil and paper—or slide cutter for one-handed film dispensing

ITEM	DESCRIPTION	CAPACITY	CORE DIAMETER
SW1218	Saf-T-Wrap® Station with Safety Blade (for film, foil or paper)	Accepts date label rolls from 0.75"-3" (1.9-7.6 cm) wide; 3.25" (8.25 cm) diameter. Dispense Film/Foil/Paper rolls from 12"-18" (30.48-42.75 cm), 5.1" (12.95 cm) total diameter	1.2" (30 mm) min.
SW1218SC	Saf-T-Wrap® Station with Slide Cutter (for film)	Accepts date label rolls from 0.75"-3" (1.9-7.6 cm) wide; 3.25" (8.25 cm) diameter. Dispense Film rolls from 12"-18" (30.48-42.75 cm), 5.1" (12.95 cm) total diameter	1.2" (30 mm) min.



SW12

Saf-T-Wrap® 12 & 18

- Accommodates film or foil rolls and saves time while minimizing waste
- Includes safety blade and slide cutter for easy cutting of film, foil, and paper.
- Film and foil rolls are fully enclosed and protected preventing cross-contamination from unsanitary cardboard cutter boxes
- Economical by utilizing entire roll and keeping your film/foil in a durable, protected dispenser; resulting in substantial cost savings

ITEM	DESCRIPTION	CAPACITY
SW12	Saf-T-Wrap® with Slide Cutter and optional Safety Blade (for film or foil)	Dispense Film/Foil rolls from 12" (305 mm)
SW18	Saf-T-Wrap® with Slide Cutter and optional Safety Blade (for film or foil)	Dispense Film/Foil rolls from 15"-18" (381 mm - 457 mm)
SWX100	Saf-T-Wrap® Stackers (2) Brackets (8) Wing Nuts	Stackers can hold (2) SW12, (2)SW18 or combination of (1) SW12 and (1) SW18



Saf-T-Label™ Dispenser **NEW**

- Easily separates labels from backing paper
- Integrated brackets to hang on wire shelving or wall-mount brackets

ITEM	CAPACITY	DIMENSIONS
STL511	Accepts date label rolls from 0.75" - 2" (1.91 - 5.08 cm) wide; 3.25" (8.26 cm) diameter	7.02"H x 19.96"W x 5.13" D (178 x 507 x 130 mm)



Saf-T-Knife® Station*

- Sanitary, safe and secure storage for kitchen knives
- Protects knives from contamination and accidents
- Easy to assemble and clean

ITEM	DIMENSIONS
STK1008	15"H x 15"W x 4¼"D (381 x 381 x 108 mm)



*Knives not included



Saf-T-Knife® Station Jr.*

- Color-coded lids designed to keep track of which knife is used for what purpose
- Perfect size for prep lines and smaller kitchens
- Easy to assemble and clean

ITEM	DESCRIPTION	DIMENSIONS
STK1006	Saf-T-Knife® Station Jr.	14½"H x 8¾" W x 4"D (368 x 211 x 102 mm)
STK1006RDL	Saf-T-Knife® Station Jr. - Red (Lid Only)	1⅞"H x 8"W x 4"D (48 x 203 x 102 mm)
STK1006GRL	Saf-T-Knife® Station Jr. - Green (Lid Only)	1⅞"H x 8"W x 4"D (48 x 203 x 102 mm)
STK1006YLL	Saf-T-Knife® Station Jr. - Yellow (Lid Only)	1⅞"H x 8"W x 4"D (48 x 203 x 102 mm)
STK1006PRL	Saf-T-Knife® Station Jr. - Purple (Lid Only)	1⅞"H x 8"W x 4"D (48 x 203 x 102 mm)



STK1006
*Knives not included



STK1006RDL



STK1006GRL



STK1006YLL



STK1006PRL



Allergen Saf-T-Zone™ Mats

- Easily identify allergen preparation is being done
- Top 8 allergens are identified on the mat to aid in employee allergen awareness
- 12" x 12" mat can be used as designated allergen area for food holding

ITEM	INCLUDES
CBMASZ1212	Server window Allergen Saf-T-Zone™ Mat 12" x 12" (304 x 304 mm)
CBMASZ2430	Prep station Allergen Saf-T-Zone™ Mat 24" x 30" (609 x 762 mm)



CBMASZ1212

California Residents: Styrene

WARNING (See Appendix C on page 183)

Allergen Saf-T-Zone™ System

- Purple color alerts staff to follow special food allergy procedures
- Includes commercial-grade cutting board, tongs, turner and Chef's knife
- Durable purple case is easy to find in the kitchen and securely protects tools and board

Additional Allergen Saf-T-Zone™ cutting boards and sizes are available on page 77.



ASZ121812SYS

ITEM	INCLUDES
ASZ121812SYS	(1) Saf-T-Grip® purple cutting board (CBG121812PR) 12" x 18" x ½" (305 x 457 x 13 mm) (1) Stainless steel chef knife with purple handle 10" (254 mm) (1) Stainless steel tongs with purple handle 12" (305 mm) (1) Stainless steel turner with purple handle 13" (330 mm) (Thermometer not included)
ASZTHERMW	Professional digital thermometer with protective sheath, dishwasher safe



Allergen Saf-T-Zone™ Cutting Board
CBG121812PR

10" Chef Knife
ASZKNIFE

12" Tongs
ASZTONGS

13" Turner
ASZTURNER



Thermometer sold separately

ASZTHERMW

SANITATION TOOLS

PAILS

TOOLS

PAILS

- Kleen-Pail®, the original dedicated non-food container for safe foodservice cleaning and sanitation
- Available in sizes for front or back-of-the house
- New, patented Kleen-Pail® Pro has curved edges for easy pouring, extended handles for carrying, and raised bottom to catch excess debris.





Kleen-Pail® Pro **NEW**

- Color-coded, trilingual pails for use with detergent or sanitizer
- Curved shape and raised bottom for easy pouring
- Molded-in handles with embossed, raised lettering to meet health code
- Built-in debris-catching ribs

ITEM	COLOR	DESCRIPTION
KPP97*	RD, GN	3 quart (2.84 L)
KPP196*	RD, GN	6 quart (5.68 L)
KPP256*	RD, GN	8 quart (7.57 L)

* Specify desired color after item number. Example: KPP97GN



KPPS196WM

Kleen-Pail® Pro Stands* **NEW**

- Allows you to move Sanitizer and Detergent Pails off of the floor or work surface
- Provides a sanitary storage holder for KPP97*, KPP196*, and KPP256*.

ITEM	DESCRIPTION
KPPS97	Kleen-Pail stand holds KPP97
KPPS97WM	Kleen-Pail wall mount stand holds KPP97
KPPS196	Kleen-Pail stand holds KPP196
KPPS196WM	Kleen-Pail wall mount stand holds KPP196
KPPS256	Kleen-Pail stand holds KPP256
KPPS256WM	Kleen-Pail wall mount stand holds KPP256

*Kleen-Pail Pro sold separately.

FOOD SAFETY TOOLS



Kleen-Pail®

- Color-coded pails for use with detergent and sanitizer
- Durable, robust handle design
- New embossed feature designed to meet health code
- Trilingual design aids in training
- Blank space for labeling purpose or placement (Kleen-Color pails only)

ITEM	COLOR	DESCRIPTION
KP97*	RD, GN	3 quart (2.84 L)
KP196*	RD, GN, PR	6 quart (5.68 L)
KP256*	RD, GN	8 quart (7.57 L)
KP320*	RD, GN, BL, YL, GR	10 quart (9.46 L)
KLEEN-COLOR PAILS		
KP196KCBL	Blue	6 quart (5.68 L)
KP196KCYL	Yellow	6 quart (5.68 L)
KP196KCRD	Red	6 quart (5.68 L)
KP196KCGN	Green	6 quart (5.68 L)

* Specify desired color after item number. Example: KP97GN

PAIL USAGE GUIDE

- RD = Sanitizer
 GN = Detergent (Cleaner)
 PR = Allergen
 WH = Broken Glass Only
BL = General Use
 YL = General Use
 GR = Janitorial

Kleen-Pail® Stands*

- Allows you to move Sanitizer and Detergent Pails off of the floor or work surface
- Provides a sanitary storage holder for KP97*, KP196*, and KP256*.



KPS196

ITEM	DESCRIPTION
KPS97	Kleen-Pail stand holds KP97
KPS97WM	Kleen-Pail wall mount stand holds KP97
KPS196	Kleen-Pail stand holds KP196
KPS196WM	Kleen-Pail wall mount stand holds KP196
KPS256	Kleen-Pail stand holds KP256
KPS256WM	Kleen-Pail wall mount stand holds KP256

*Kleen-Pail sold separately.



Kleen-Pail® Broken Glass Container **NEW**

- White color and label designates that only broken glass should be placed into container
- Large spout makes it easy to empty

ITEM	COLOR	DESCRIPTION
KP320WH	WH	10 quart (9.46 L)



Kleen-Pail® Caddy™ System

- Integrated spray bottle creates portable cleaning and sanitizing system
- Saves time and reduces labor
- Trilingual design aids in training

ITEM	DESCRIPTION
KP500	(1) green caddy (1) spray bottle
KP550GN	(1) green caddy

TOOLS

- Make proper sanitation easier, more efficient and meet health codes
- Unique, patented products combine several processes for convenience and safety



SFC1200QT

Saf-Check®

- Combines thermometer and sanitizer test strips with easy-to-read Smart Scale™ guide
- Thumb wheel easily dispenses test strips
- Holds replaceable 15 ft. (4.57 m) roll of Chlorine or Quaternary test strips

ITEM	DESCRIPTION
MEASURES	
SFC1200CL	Chlorine measure with thermometer
SFC1200QT	Quaternary measure with thermometer
SFC1250CL	Chlorine measure without thermometer
SFC1250QT	Quaternary measure without thermometer
REPLACEMENT TEST STRIP ROLLS	
SFCROLLCL	Chlorine replacement rolls (2) 15 ft. rolls
SFCROLLQT	Quaternary replacement rolls (2) 15 ft. rolls



Kleen-Cup®

- Effectively cleans and sanitizes mixer spindles, replaceable brushes
- Prevents flavor transfer and cross-contamination

ITEM	DESCRIPTION	DIMENSIONS
KLC28C	(1) Kleen-Cup spindle sanitizer	7¾"H x 4"D (197 x 102 mm)



Fridge-Kare™

- Removes moisture from the air and reduces odor in walk-in and reach-in coolers
- Decreases bacteria and mold growth

ITEM	DESCRIPTION
FK1000	One Fridge-Kare® treats 250 cubic feet for up to 6 months

ServSafe® Coursebook 7th Edition

- Prepares foodservice professionals for extended one-day or two-day certification programs

ITEM	DESCRIPTION
SERVSABOOK	Course book for ServSafe® certification based on updated 2013 FDA food code



ServSafe® is a registered trademark of the National Restaurant Association Education Foundation

Smart Charts

- Instructional charts for color-coding cutting boards, using Rapi-Kool® chill paddles and proper handwashing practices

ITEM	INCLUDES	DIMENSIONS
RCUWLCT	Rapi-Kool® Smart Chart	17"H x 11"W (432 x 279 mm)
CBCWLCTST	Color-Coded Cutting Board Smart Chart	17"H x 11"W (432 x 279 mm)
QSWLCT	Cut-N-Carry® 4 Board Color-Coded Smart Chart	11½"H x 14½"W (292 x 368 mm)
HWWLCT	Hand Washing Station Smart Chart	9"H x 6"W (229 x 152 mm)



HACCP Food Safety Kit

- Train staff or students in basic food safety principles with products designed to aid with HACCP procedures

ITEM	DESCRIPTION
HACCPKIT	Saf-T-Ice® Shorty™ Tote (Item #SI6100)
	Saf-T-Ice® Lid (Item# SI6500)
	Saf-T-Scoop® & Guardian System™ (Item #SI5000)
	Rapi-Kool® Plus Cold Paddle (Item #RCU64V2)
	Rapi-Kool® Smart Chart (Item #RCUWLCT)
	Saf-T-Grip® Cutting Board (Item #CBG121812GN)
	Cutting Board Smart Chart (Item #CBCWLCTST)
	Kleen-Pail® 3-QT (Item #KP97GN)
	Kleen-Pail® 6-QT (Item #KP196RD)
	Kleen-Plug™ (Item # KLP200)
	Saf-T-Grip® Board-Mate (Item# CBM1318)
	Saf-T-Grip® Allergen Saf-T-Zone™ 9" x 12" Cutting Board (Item #CBG912PR)
	Saf-Check® Quat Test System with thermometer (Item #SFC1200QT)
	Mani-Kare® Bandages (Item #MK0901)
	Versa Mat® Bar Matting (Item #VM5280BK)
	T-Stick® Samples 140° F, 160° F and 170° F (Item #TST9341, #TST9343, #TST9345)
	Klever Kutter™ 3-Pack (Item #KK403)



California Residents: Bisphenol A

WARNING (See Appendix A on page 183)

California Residents: Styrene

WARNING (See Appendix C on page 183)

CUTTING BOARDS

GRIP BOARDS

STANDARD BOARDS

SPECIALTY & CUSTOM BOARDS

ACCESSORIES

GRIP BOARDS

- Saf-T-Grip® integrated grip corners provide a safe and secure prep surface
- Durable co-polymer and molded-in grips designed to stand up to the toughest commercial kitchen environments
- Integrated ruler makes portioning easy, eliminating guess-work and saving money
- Patented Food Safety Hook allows for sanitary transport and storage

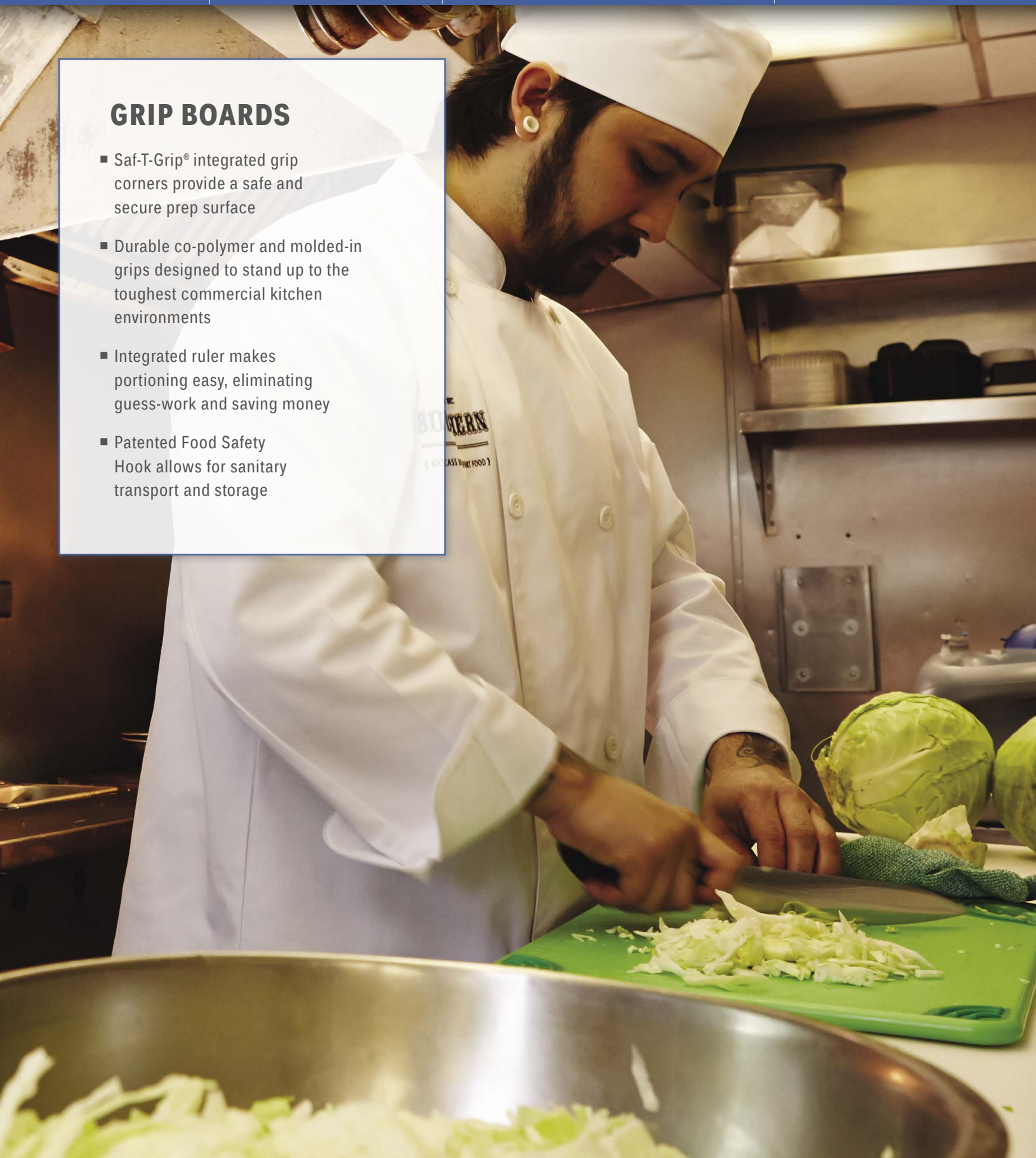



Saf-T-Grip® Cutting Boards

- Integrated anti-slip grips securely hold board in place
- Patented Food Safety Hook for sanitary transport and storage
- Durable co-polymer material will not warp

ITEM	COLOR	DIMENSIONS
CBG6938*	BK, GN, RD, WH, YL	6"H x 9"W x 3/8"D (152 x 229 x 9.5 mm)
CBG912*	BL, BR, GN, RD, WH, YL	9"H x 12"W x 3/8"D (229 x 305 x 9.5 mm)
CBG121812*	BL, BR, GN, RD, WH, YL	12"H x 18"W x 1/2"D (305 x 457 x 13 mm)
CBG152012*	BL, BR, GN, RD, WH, YL	15"H x 20"W x 1/2"D (381 x 508 x 13 mm)
CBG182412*	BL, BR, GN, RD, WH, YL	18"H x 24"W x 1/2"D (457 x 610 x 13 mm)



* Specify desired color after item number. Example: CBG6938BK





Saf-T-Grip® White Cutting Boards

- Reduce cross-contamination with color-coded cutting boards
- All the great features and benefits of our Saf-T-Grip® family, with the tradition of a white cutting board
- Durable co-polymer material will not warp

ITEM	COLOR	DIMENSIONS
CBGW912*	BL, GN, YL, RD	9"H x 12"W x ¾"D (229 x 305 x 9.5 mm)
CBGW152012*	BL, GN, YL, RD	15"H x 20"W x ½"D (381 x 508 x 13 mm)



Saf-T-Grip® White 4-Board System

- Reduce cross-contamination with color-coded cutting boards
- All the great features and benefits of our Saf-T-Grip® family, with the tradition of a white cutting board
- Durable co-polymer material will not warp

ITEM	COLOR	DIMENSIONS
WHITE BOARDS WITH (EACH) OF THE COLORED GRIPS: GREEN, RED, YELLOW AND WHITE		
CBGW912QS	WH, GN, YL, RD	9"H x 12"W x ¾"D (229 x 305 x 9.5 mm)
CBGW152012QS	WH, GN, YL, RD	15"H x 20"W x ½"D (381 x 508 x 13 mm)



Saf-T-Grip® 6-Board System

- Reduce cross-contamination with color-coded cutting boards
- Customizable color-coding Smart Chart™ with stickers available upon request
- Durable co-polymer material will not warp

ITEM	DIMENSIONS
CONTAINS (EACH) BLUE, BROWN, GREEN, RED, WHITE, YELLOW CUTTING BOARDS	
CBG1218KC	12"H x 18"W x ½"D (305 x 457 x 13 mm)
CBG1520KC	15"H x 20"W x ½"D (381 x 508 x 13 mm)
CBG1824KC	18"H x 24"W x ½"D (457 x 610 x 13 mm)



Saf-T-Grip® Bar/Snack Boards

- Durable co-polymer construction will not warp
- Material won't dull knives and resists unsanitary cut-grooving
- Smaller size is ideal for tight spaces

ITEM	COLOR	DIMENSIONS
CBG6938*	BK, GN, RD, WH, YL	6"H x 9"W x ¾"D (152 x 229 x 9.5 mm)



STANDARD BOARDS

- Premium cutting boards with Cut-N-Carry® patented Food Safety Hook
- Color options allow for color-coding to minimize cross-contamination during prep

Cut-N-Carry® Color Cutting Boards

- Patented Food Safety Hook design for sanitary transport and storage
- Durable co-polymer construction provides superior heat, chemical and warp resistance
- Material won't dull knives and resists unsanitary cut-grooving

ITEM	COLOR	DIMENSIONS
CB101212*	GN, YL	10"H x 12"W x ½"D (254 x 305 x 13 mm)
CB121812*	BL, BR, GN, RD, YL	12"H x 18"W x ½"D (305 x 457 x 13 mm)
CB152012*	BL, BR, GN, RD, YL	15"H x 20"W x ½"D (381 x 508 x 13 mm)
CB182412*	BL, BR, GN, RD, YL	18"H x 24"W x ½"D (457 x 610 x 13 mm)
CB121834*	BL, BR, GN, RD, YL	12"H x 18"W x ¾"D (305 x 457 x 19 mm)
CB182434*	BL, BR, GN, RD, YL	18"H x 24"W x ¾"D (457 x 610 x 19 mm)



Cut-N-Carry® 4 & 6-Board Systems

- Reduce cross-contamination with color-coded cutting boards
- Customizable color-coding Smart Chart™ with stickers available upon request
- Durable co-polymer construction provides superior heat, chemical and warp resistance

ITEM	DESCRIPTION	DIMENSIONS
CB1218QS	4-Board System: (1ea) green, red, white, yellow cutting boards	12"H x 18"W x ½"D (305 x 457 x 13 mm)
CB1520QS		15"H x 20"W x ½"D (381 x 508 x 13 mm)
CB1824QS		18"H x 24"W x ½"D (457 x 610 x 13 mm)
CB1218KC	6-Board System: (1ea) blue, brown, green, red, white, yellow cutting boards	12"H x 18"W x ½"D (305 x 457 x 13 mm)
CB1520KC		15"H x 20"W x ½"D (381 x 508 x 13 mm)
CB1824KC		18"H x 24"W x ½"D (457 x 610 x 13 mm)



4-Board Cut-N-Carry® System



* Specify desired color after item number. Example: CBGW912BL



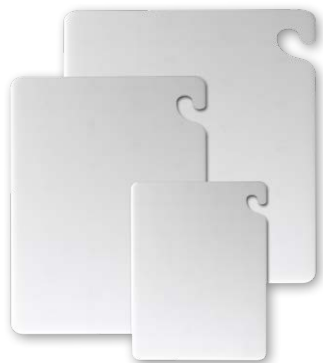

Cut-N-Carry® White Cutting Boards

- Patented Food Safety Hook design for sanitary transport and storage
- Material won't dull knives and resists unsanitary cut-grooving
- Durable co-polymer construction will not warp

ITEM

CB101212WH
CB121812WH
CB152012WH
CB182412WH
CB183012WH
CB242412WH
CB121834WH
CB152034WH
CB182434WH
CB183034WH
CB242434WH

DIMENSIONS

10"H x 12"W x ½"D (254 x 305 x 13 mm)
 12"H x 18"W x ½"D (305 x 457 x 13 mm)
 15"H x 20"W x ½"D (381 x 508 x 13 mm)
 18"H x 24"W x ½"D (457 x 610 x 13 mm)
 18"H x 30"W x ½"D (457 x 762 x 13 mm)
 24"H x 24"W x ½"D (610 x 610 x 13 mm)
 12"H x 18"W x ¾"D (305 x 457 x 19 mm)
 15"H x 20"W x ¾"D (381 x 508 x 19 mm)
 18"H x 24"W x ¾"D (457 x 610 x 19 mm)
 18"H x 30"W x ¾"D (457 x 762 x 19 mm)
 24"H x 24"W x ¾"D (610 x 610 x 19 mm)



White Cutting Boards

- Material won't dull knives and resists unsanitary cut-grooving
- Durable co-polymer construction will not warp

ITEM

CB12181WH
CB15201WH
CB18241WH

DIMENSIONS

12"H x 18"W x 1"D (304 x 457 x 25 mm)
 15"H x 20"W x 1"D (381 x 508 x 25 mm)
 18"H x 24"W x 1"D (457 x 609 x 25 mm)



White Grooved Cutting Boards

- Groove design reduces cross-contamination by stopping food juices from spilling onto countertops and food prep areas
- Reduces mess and clean-up
- Durable co-polymer construction will not warp



ITEM

CB121812GVWH
CB152012GVWH
CB182412GVWH
CB182434GVWH

DIMENSIONS

12"H x 18"W x ½"D (305 x 457 x 13 mm)
 15"H x 20"W x ½"D (381 x 508 x 13 mm)
 18"H x 24"W x ½"D (457 x 610 x 13 mm)
 18"H x 24"W x ¾"D (457 x 610 x 19 mm)



SPECIALTY & CUSTOM BOARDS

- Available in co-polymer and our patented Tuff-Cut® high-heat materials
- Choose a standard size or customize to accommodate any application

White Bar Board

- Material won't dull knives and resists unsanitary cut-grooving
- Smaller size is ideal for tight spaces
- Durable co-polymer construction will not warp

ITEM

CB6912WH

DIMENSIONS

6"H x 9"W x ½"D (152 x 229 x 13 mm)



Tuff-Cut® Cutting Boards

- Designed for high-heat applications
- Rated to withstand temperatures up to 350°F (177°C) without warping or scorching
- Ideal for use as pizza peels and meat carving

ITEM

TC121812

TC152012

TC182412

TC121812GV

TC152012GV

TC182412GV

DESCRIPTION

Regular cutting board

Regular cutting board

Regular cutting board

Grooved cutting board

Grooved cutting board

Grooved cutting board

DIMENSIONS

12"H x 18"W x ½"D (305 x 457 x 13 mm)

15"H x 20"W x ½"D (381 x 508 x 13 mm)

18"H x 24"W x ½"D (457 x 610 x 13 mm)

12"H x 18"W x ½"D (305 x 457 x 13 mm)

15"H x 20"W x ½"D (381 x 508 x 13 mm)

18"H x 24"W x ½"D (457 x 610 x 13 mm)



Regular

Grooved

Tuff-Cut® Bread Boards

- Designed for high-heat applications and serrated knife use
- Rated to withstand temperatures up to 350°F (177°C) without warping or scorching
- Different sizes and shapes for bread cutting and serving

ITEM

TC7501

TC7502

TC7503

DESCRIPTION

Bread board with 5" (127 mm) handle

Bread board with 6" (152 mm) handle

Bread board with 4" (102 mm) handle & butter well

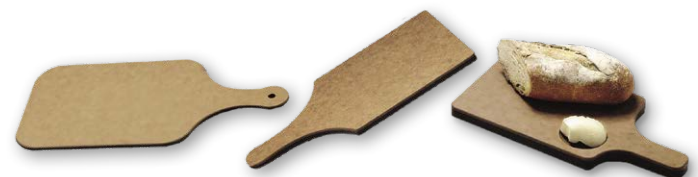

TC7501

TC7502

TC7503

DIMENSIONS

7"H x 9"W x ¼"D (178 x 229 x 6 mm)

7"H x 9"W x ½"D (178 x 229 x 13 mm)

8½"H x 6½"W x ¼"D (216 x 165 x 19 mm)





Tuff-Cut® Custom Cutting Boards

- Same high-quality Tuff-Cut® material in custom sizes and shapes
- Ships within 48 hours

ITEM	THICKNESS
TC4812014	¼" (6 mm)
TC4812038	⅜" (9.5 mm)
TC4812012	½" (13 mm)
TC4812034	¾" (19 mm)
TC481201	1" (25 mm)

All cuts are straight edge unless otherwise requested (additional cost).



Custom-Cut Cutting Boards

- High-quality material is durable, heat-resistant and will not dull knives
- Ships within 48 hours

ITEM	COLOR	THICKNESS
CBL6012012	GN, RD, YL, BL, BR, WH	½" (13 mm)
CBL6012034	White only	¾" (19 mm)
CBL601201	White only	1" (25 mm)

Special cuts, holes and patterns are available at an additional cost.

All cuts are straight edge unless otherwise requested (additional cost).

Complex cuts and large quantities (over 15) may take longer than 48 hours.



HOW TO ORDER A CUSTOM CUTTING BOARD

Step 1: Pick your thickness from choices above

Step 2: Pick your size - any size

Step 3: Call in your order to Customer Care **1.800.248.9826** or email us at **sjorders@sanjamar.com**

Visit our online Custom Cutting Board Calculator: <http://customcutbrd.sanjamar.com>

Please Note: Special cuts, holes and patterns are available at an additional cost. All cuts are straight edge unless otherwise requested (additional cost).

Complex cuts and large quantities (over 15) may take longer than 48 hours. ¾" boards and 1" boards are only available in white.



ACCESSORIES

- Convenient cutting board storage, Board Mate® non-slip board mats and cutting board brushes

Sparta® Spectrum® Cutting Board Brushes **NEW**

- Color-coded to prevent cross-contamination
- Ergonomic handles provide comfortable grip
- 4-Pack

ITEM	COLOR	DIMENSIONS
CBB6*	Blue (BL), Brown (BR), Green (GN), Red (RD), Yellow (YL), White (WH), Purple (PR)	6"L x 2"W (152 x 50.8 mm) Bristle Length: 1.38" (35 mm)

* Specify desired color after item number. Example: CBB6BL



Saf-T-Grip® Board Mate®

- Replaces unsanitary "wet towel" to keep non-grip boards from shifting and sliding
- Reduces knife accidents and injuries during prep
- Also keeps countertop appliances from slipping

ITEM	DIMENSIONS
CBM1016	10"L x 16"W (254 x 406 mm)
CBM1318	13"L x 18"W (330 x 457 mm)
CBM1622	16"L x 22"W (406 x 559 mm)

California Residents: Styrene

WARNING (See Appendix C on page 183)



Cutting Board Accessories

ITEM	DESCRIPTION
KLRST	Cutting board storage stand with non-slip feet
CNCRK	Shelf-mounting hanging rack
CBCWLCTST	Color-coded cutting board smart chart / 6-board with stickers
QSWLCT	Color-coded cutting board smart chart / 4-board
1178902	Cutting Board Refinisher
1179944	Replacement Finisher Blades (2 Pk)



KLRST



CNCRK

1178902

QUAD-SET

CUSTOMIZABLE CUTTING BOARD COLOR CODING CHART

STEPS TO SANITARY FOOD PREP

QSWLCT

CBCWLCTST

BAR & FOOD MANAGEMENT

In the hectic world of foodservice – safety, efficiency, and looking good to your patron, is paramount. From proper ice handling and food storage, to clean-up, San Jamar is responsive to foodservice operators, continuously creating new tools to make life a little easier in the kitchen, at the bar and at the dining table.



**BAR
MANAGEMENT**

**FOOD
MANAGEMENT**



KITCHEN MANAGEMENT

MEASUREMENT TOOLS

BAR MANAGEMENT

BAR TOOLS

GARNISH CENTERS

SHELF MATTING

BAR TOOLS

- Smart solutions to make bar service more efficient
- Designed by bartenders for bartenders





Kleen Plug™

- Protects beer taps and bottles from fruit flies and other contaminants
- Affordable and easy-to-use
- Seals and protects beverage station drains

ITEM	DESCRIPTION	QUANTITY
KLP200	Kleen Plug™ Blister Pack	5
KLP250	Bulk Kleen Plugs™	50

Construction: High-impact plastic



Perfect Pitcher™ **NEW**

- Patented "double-angled wall" reduces excess foaming that causes waste
- Allows bartenders to take orders, close tabs, and make other beverages for customers while pitcher fills
- Low profile design

ITEM	CAPACITY	DIMENSIONS
PPP60	60 oz (1.8 L)	9"H x 6.5"W x 7"D (228 x 165 x 178 mm)



CBG6938RD



CB6912WH

Bar Boards

- Durable co-polymer construction provides superior heat, chemical and warp resistance
- Material won't dull knives and resists unsanitary cut-grooving
- Ideal for garnish prep at bar area

ITEM	COLOR	DESCRIPTION	DIMENSIONS
CBG6938*	BK, GN, RD, WH, YL	Integrated anti-slip grip cutting board	6"H x 9"W x 3/8"D (152 x 229 x 9.5 mm)
CB6912WH	White	Co-polymer cutting board	6"H x 9"W x 1/2"D (152 x 229 x 13 mm)



Non-Alcoholic Bar Mat

- Designate a reserved area to place non-alcoholic beverages
- Made of nitrile rubber, mats are non-slip to keep the glasses in place and the countertop clean

ITEM	DIMENSIONS
BM1018	10"H x 18"W x 1/4"D (254 x 457 x 6.35 mm)

California Residents: Styrene

WARNING (See Appendix C on page 183)



Saf-T-Ice® Bottle Guardian

- Safely chills wine and liquor bottles inside of ice bin
- Can be mounted inside or outside ice bin, keeping non-chilled bottles handy
- Durable construction; dishwasher safe

ITEM	DESCRIPTION
S17000BG	(1) Guardian holder with removable drainage cap, (1) Set mounting tools; Max bottle diameter 3 3/4"

Construction: Polycarbonate

California Residents: Bisphenol A

WARNING (See Appendix A on page 183)



* Specify desired color after item number. Example: CBG6938BK



Stainless Steel Speed Rails

- Attractive and durable stainless steel construction
- Available in single and double rails
- Holds quart and liter bottles

ITEM	DESCRIPTION	DIMENSIONS
B5522	Holds (5) 1 qt. (0.95 L) bottles	6"H x 21¼"W x 4¾"D (152 x 540 x 105 mm)
B5532	Holds (8) 1 qt. (0.95 L) bottles	6"H x 31½"W x 4¾"D (152 x 791 x 105 mm)
B5542	Holds (10) 1 qt. (0.95 L) bottles	6"H x 41¼"W x 4¾"D (152 x 1048 x 105 mm)
B500	Hanger Straps for Single Speed Rails	8¾"H x 1"W x 2½"D (213 x 25 x 54 mm)
B5522D	Holds (10) 1 qt. (0.95 L) bottles	7½"H x 21¼"W x 8"D (194 x 537 x 203 mm)
B5532D	Holds (16) 1 qt. (0.95 L) bottles	7½"H x 31½"W x 8"D (194 x 791 x 203 mm)
B5542D	Holds (20) 1 qt. (0.95 L) bottles	7½"H x 41¼"W x 8"D (194 x 1048 x 203 mm)

Construction: 22-gauge stainless steel



B5522



HANGER STRAPS

Hanger Straps can be used only with the single stainless steel rails. Offers portability for multiple uses. Made of durable stainless steel.

B500

Wire Speed Rails

- Durable silver granite finish will not rust
- Holds quart and liter bottles
- Economical, ideal for outdoor use

ITEM	DESCRIPTION	DIMENSIONS
B5624SG	Holds (6) 1 qt. (0.95 L) bottles	6"H x 24"W x 4½"D (152 x 610 x 114 mm)
B5636SG	Holds (9) 1 qt. (0.95 L) bottles	6"H x 36"W x 4½"D (152 x 914 x 114 mm)

Construction: Heavy gauge formed wire



B5624SG

Bottle Cap Catcher

- Mounts easily under any bottle cap opener
- Durable stainless steel construction for years of use

ITEM	DIMENSIONS
B4300	13¾"H x 5¾"W x 3¼"D (333 x 137 x 83 mm)

Construction: 22-gauge stainless steel



Bar Caddy

- Holds cocktail napkins, straws, stir sticks and more

ITEM	DIMENSIONS
B400BK	4¾"H x 9¼"W x 5½"D (105 x 235 x 140 mm)

Construction: High-impact plastic



GARNISH CENTERS

- Multiple options to organize & serve garnishes
- Enhances image and sanitation
- Chillable tray options available

THE DOME® & MINI DOME® PRODUCT DIMENSIONS

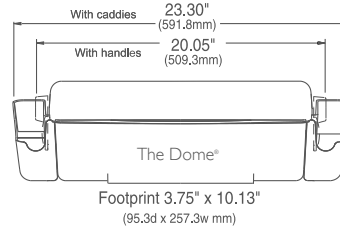

The Dome® Garnish Centers

- Patented, domed lid rotates back for easy access and increased capacity when closed
- Use standard size trays to keep food chilled or deep trays for extra capacity
- Integrated snap-on caddies store straws, stirrers & picks



BD4005E

ITEM	DESCRIPTION	CAPACITY
BD4005S	(1) 2 qt. (1.9 L) deep tray; (4) 1 pt. (0.47 L) standard trays; (2) snap-on caddies, handles	4 qt. (3.8 L)
BD4005E	(1) 2 qt. (1.9 L) deep tray; (4) 1 pt. (0.47 L) standard trays; (2) end caps; (1) snap-on caddy	4 qt. (3.8 L)
BD4023S	(2) 3 pt. (1.4 L) deep trays; (3) 1 pt. (0.47 L) standard trays; (2) snap-on caddies, handles	4.5 qt. (4.25 L)
BD4006S	(6) 1 pt. (0.47 L) standard trays; (2) snap-on caddies, handles	3 qt. (2.8 L)
BD4003	(3) 2 qt. (1.9 L) quart deep trays; (2) handles	6 qt. (5.6 L)
BD4004	(4) 3 pt. (2.9 L) deep trays; (2) handles	6 qt. (5.6 L)
BD4014	(4) 1.5 pt. (0.71 L) standard trays; (2) handles	3 qt. (2.8 L)

Construction: High-impact plastic



Mini Dome® Garnish Centers

- Patented, domed lid design in a smaller size; notched lid option
- Optional connectors provide modularity between Mini Dome®, Dome® and snap-on caddies

ITEM	DESCRIPTION	CAPACITY
EACH MINI DOME® COMES WITH (2) END CAPS		
BD2001	(1) 2 qt. (1.9 L) deep tray	2 qt. (1.9 L)
BD2002	(1) 1 qt. (0.95 L) standard tray	1 qt. (0.95 L)
BD2003	(2) 1 pt. (0.47 L) standard trays	2 pt. (0.47 L)
BD2004NL	(2) 1.5 pt. (0.71 L) deep trays (notched domed lid)	3 pt. (1.4 L)
BD2002CAR	(1) 1 qt. (0.95 L) standard tray (with caddy)	1 qt. (0.95 L)
BD2004CAL	(2) 1.5 pt. (0.71 L) deep trays (with left hand caddy)	3 pt. (1.4 L)

Construction: High-impact plastic



BD2001

The Dome® Glass Rimming Station

- Comprehensive bar management system
- Promotes all-in-one station for serving beverages/cocktails
- Allows for storage of bar board and paring knife

ITEM	DESCRIPTION
BDRX400	Rimming Station to be used with The Dome® Garnish Centers Includes (3) 5" round trays, (1) 4" round tray and (1) sponge for 5" tray

Construction: High-impact plastic



BDRX400, BD4005S
(The Dome® Garnish Center and cutting board are not included)

Dome® Stacker

- Allows you to customize a configuration using Dome® and Mini Dome® to fit virtually any space
- Makes your operation more efficient, more organized and more professional

ITEM	DESCRIPTION	CAPACITY
BDSX100	Dome® Stacker Conversion Kit - converts your Dome® and Mini Dome® into a versatile, organized garnish center (Dome and Mini Dome not included)	N/A
BDS2203	Dome® Stacker - 1/1 Mini Dome: (4) 1 pt. trays & bonus (2) 2 qt. trays	4 qt. (3.8 L)
BDS2204NL	Dome® Stacker - 1/1 Mini Dome: (4) 1.5 pt. deep trays - notched lids & bonus (2) 2 qt. trays	4.5 qt. (4.25 L)
BDS2401NL	Dome® Stacker - 2/2 Mini Domes: (4) 2 qt. deep Trays	3 qt. (2.8 L)
BDS2483NL	Dome® Stacker - 2/2 Mini Domes: (4) 1.5 pt. deep trays, (4) 1 pt. standard trays, (2) notched lids & (2) standard lids	6 qt. (5.6 L)
BDS4206	Dome® Stacker - 1/1 Dome®: (12) 1 pt. standard trays	6 qt. (5.6 L)
BDS4266	Dome® Stacker - 1/1 Dome®: (3) 2 qt. deep trays, (6) 1 pt. standard trays (chillable)	3 qt. (2.8 L)

Construction: High-impact plastic



BDS4266



BDS2483NL

The Dome® & Mini Dome® Replacements

- Choose from a wide variety of tray configurations; chillable and non-chillable
- Snap-on caddies and connectors available for maximum flexibility

ITEM	DESCRIPTION	QUANTITY
BD100S	Snap-on caddies	2
BD101	1 pt. (0.47 L) standard tray - chillable	12
BD102	1.5 pt. (0.71 L) standard tray - chillable - for Dome® only	6
BD103	3 pt. (1.4 L) deep tray - for Dome® only	6
BD104	2 qt. (1.9 L) deep tray	6
BD105	1.5 pt. (0.71 L) deep tray	6
BD106	1 qt. (0.95 L) standard tray - chillable	6
BD110	Connector	1

Construction: High-impact plastic





B6186L

EZ-Chill™ Garnish Centers

- Portable and chillable stainless steel garnish centers
- Hinged, transparent lid protects garnishes and will not rust
- For use with EZ-Chill™ ice packs or ice

ITEM	DESCRIPTION	DIMENSIONS
B6183L	(3) 1 qt. (0.95 L) inserts with plex lid; (1) Ice liner; (3) EZ-Chill packs	5 $\frac{5}{8}$ "H x 18"W x 5 $\frac{3}{8}$ "D (149 x 457 x 137 mm)
B6186L	(6) 1 pt. (0.47 L) inserts with plex lid; (1) Ice liner; (3) EZ-Chill packs	5 $\frac{5}{8}$ "H x 18"W x 5 $\frac{3}{8}$ "D (149 x 457 x 137 mm)
B6766L	(3) 1 qt. (0.95 L) inserts; (12) 1 pt. (0.47 L) containers; (2) Bar caddies; (2) Ice liners; (6) EZ-Chill ice packs	12 $\frac{3}{4}$ "H x 20 $\frac{1}{8}$ "W x 12"D (324 x 530 x 305 mm)

Construction: 22-gauge stainless steel with high-impact plastic



B4186L

Non-Chilled Garnish Trays

- Attractive stainless steel construction provides years of use
- Transparent lids protect garnishes; split lid option
- Interchangeable pint and quart inserts are easy-to-clean

ITEM	DESCRIPTION	DIMENSIONS
B4093L	(3) 1 pt. (0.47 L) inserts with plex lid	3 $\frac{1}{2}$ "H x 9 $\frac{1}{8}$ "W x 5 $\frac{3}{4}$ "D (89 x 232 x 146 mm)
B4124L	(4) 1 pt. (0.47 L) inserts with plex lid	3 $\frac{1}{2}$ "H x 12 $\frac{1}{8}$ "W x 5 $\frac{3}{4}$ "D (89 x 308 x 146 mm)
B4155L	(5) 1 pt. (0.47 L) inserts with plex lid	3 $\frac{1}{2}$ "H x 15"W x 5 $\frac{3}{4}$ "D (89 x 381 x 146 mm)
B4186L	(6) 1 pt. (0.47 L) inserts with plex lid	3 $\frac{1}{2}$ "H x 18"W x 5 $\frac{3}{4}$ "D (89 x 457 x 146 mm)
SPLIT-LID DESIGN		
B4246L	(2) 1 qt. (0.95 L) inserts; (4) 1 pt. (0.47 L) inserts with split-lids	3 $\frac{1}{2}$ "H x 24"W x 5 $\frac{3}{4}$ "D (89 x 610 x 146 mm)

Construction: 22-gauge stainless steel with high-impact plastic

Plastic Tray Inserts & Accessories

- Make the most of your condiment center with interchangeable trays



B432

L1035

ITEM	DESCRIPTION	DIMENSIONS	QUANTITY
B416	1 pt. (16 oz.) (473 ml)	2 $\frac{1}{2}$ "H x 5"W x 2 $\frac{7}{8}$ "D (64 x 127 x 73 mm)	12
B432	1 qt. (32 oz.) (946 ml)	5 $\frac{7}{8}$ "H x 2 $\frac{3}{4}$ "W x 5 $\frac{1}{2}$ "D (149 x 70 x 140 mm)	12
L1035	Stir stick/Straw caddy	4 $\frac{1}{2}$ "H x 5"W x 3"D (114 x 127 x 76 mm)	1

Construction: High-impact plastic

SHELF MATTING

- Protect glassware from breakage and contamination
- Options and colors for every application

Versa-Mat®

- Versatile interlocking mats to line shelves and sinks
- Design allows for sanitary airflow under glassware
- Flexible and easy to cut to any shape or size

ITEM	COLOR	DESCRIPTION	DIMENSIONS
VM5280*	BK, CL, RD, WN	Interlocking Bar Matting	12"H x 12"W (305 x 305 mm)
VM5280*-12	BK, CL, RD, WN	Interlocking Bar Matting - 12 pk	12"H x 12"W (305 x 305 mm)

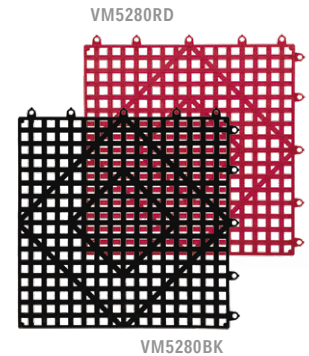

Versa-Mat® Strips

- Sized in interlocking strips to fit under beer taps

ITEM	COLOR	DESCRIPTION	DIMENSIONS
VM5180BK	Black	Interlocking Bar Matting	3½"H x 12"W (89 x 305 mm)



Ultraliner™

- Pliable, soft plastic shelf liner
- Protects glassware from breakage
- Matte finish is available in three colors

ITEM	COLOR	DIMENSIONS
UL510*	3 (Clear), 4 (White), 5 (Black)	2'H x 10'W (61 x 305 cm)
UL540*	3 (Clear), 5 (Black)	2'H x 40'W (61 x 1219 cm)



UL5105

Poly-Liner™

- Pliable, soft plastic shelf liner
- Protects glassware from breakage
- Glossy finish is available in two colors

ITEM	COLOR	DIMENSIONS
PL010*	3 (Clear), 5 (Black)	2'H x 10'W (61 x 305 cm)
PL040*	3 (Clear), 5 (Black)	2'H x 40'W (61 x 1219 cm)



PL0103

* Specify desired color after item number: Example: UL5103, VM5280BK



FOOD MANAGEMENT

FOOD STORAGE

FOOD TOOLS

CONDIMENT CENTERS

PUMP CENTERS



FOOD STORAGE

- Patented stackable design of ModPans™ allow you to keep refrigerated and dry foods conveniently organized and utilize maximum storage space

DESSERT



ModPans™

- ModPans™ include friction fit lids that keep food safe, eliminating the need for wrapping pans with messy plastic wrap or aluminum foil
- Fits in standard make/prep tables – direct from refrigerator to table, making this a convenient solution for any kitchen
- Made of odor and stain resistant transparent polypropylene in Gastronorm sizes, as specified in the EN 631 standards, available in 1 quart, 2 quart, 4 quart, and 9 quart pans

ITEM	DESCRIPTION	CAPACITY	QUANTITY
MP19	¼ food pan with lid - 5¼" (384 mm) deep	1 quart (.95 L)	12 ea / case
MP16	¼ food pan with lid - 4¼" (105 mm) deep	2 quart (1.9 L)	12 ea / case
MP14	¼ food pan with lid - 6½" (165 mm) deep	4 quart (3.8 L)	12 ea / case
MP13	¼ food pan with lid - 5½" (140 mm) deep	4 quart (3.8 L)	12 ea / case
MP12	½ food pan with lid - 6" (152 mm) deep	9 quart (8.6 L)	6 ea / case
ALLERGEN LID ONLY			
MPL19PR	¼ purple lid only		6 ea
MPL16PR	¼ purple lid only		6 ea
MPL14PR	¼ purple lid only		6 ea
MPL13PR	¼ purple lid only		6 ea
MPL12PR	½ purple lid only		6 ea

Construction: Polypropylene



FOOD TOOLS



Fryer Basket Identifiers **NEW**

- HACCP colors for color-coding fryer vats
- Contoured design fits most fryer basket handles

ITEM	COLOR	DIMENSIONS (HxWxD)
807FB*	BL (Blue), YL (Yellow), BK (Black), PR (Purple)	2.45" x 2.33" x 0.56" (62 x 59 x 14 mm)
COMBO PACK		
ITEM	INCLUDES	DIMENSIONS (HxWxD)
807FBPK	(2) Blue, (2) Yellow, (1) Black, (1) Purple	2.45" x 2.33" x 0.56" (62 x 59 x 14 mm)



Cheese Cloth

- High-grade, 100% lintless cotton
- Silicone-free, biodegradable and incinerable
- Perfect for preserving cheese, straining, steaming, poaching, as well as cleaning and polishing

ITEM	GRADE	DESCRIPTION	DIMENSIONS
G-10	Grade 10	Bulk packaged	36" x 80 yards (0.9 x 73 m)
G-40	Grade 40	Bulk packaged	36" x 70 yards (0.9 x 64 m)
G-80	Grade 80	Bulk packaged	36" x 60 yards (0.9 x 55 m)
G-10-R	Grade 10	Merchandiser packaged	4 sq. yards/package
G-40-R	Grade 40	Merchandiser packaged	4 sq. yards/package

Professional Squeeze Bottles

- Professional-grade squeeze bottles for drizzling, pooling and plate decorating
- Ideal for travel, competitions, demos and more



ITEM	DESCRIPTION	CAPACITY	QUANTITY
P8004	For drizzling, plating and decorating	4oz. (118 ml)	12
P8008	For drizzling, plating and decorating	8oz. (237 ml)	12
P8012	For plating, saucing and storing	12oz. (355 ml)	12
P8024	For plating, saucing and storing	24oz. (710 ml)	12



Bag Boa™ Bag Cutter and Squeegee **NEW**

- Safely opens food bags
- Integrated squeegee eliminates food waste
- Ergonomic grip for ambidextrous use

ITEM	DIMENSIONS
BB100	13.5"L x 1.75"W x .25"D (330 x 44.5 x 6 mm)



Not intended for use on cardboard cartons. For carton use, please see Klever Kutter on page 169.

Poly-Roll™ Rolling Pin

- Durable non-porous, stain-resistant material will not chip, crack or peel
- No cavities that could cause cross-contamination; dishwasher safe
- Can be chilled for increased stick-resistance

ITEM	LENGTH
RP15	15" (381 mm) / 23" (584 mm) (including handles)
RP18	18" (457 mm) / 26" (660 mm) (including handles)

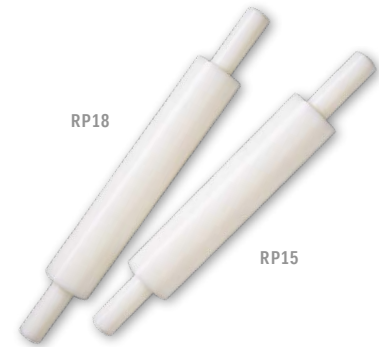

8" (203 mm) Combo Sharpening Stone

- Reversible carbon oxide sharpener
- Gray side has course 150 grit; Orange side has fine 400 grit
- Strong rubber-grip holder

ITEM	LENGTH
CB1008	8" (203 mm)



Butcher's Trussing Twine

- For trussing and tying poultry, ham, seasoning bouquets and more

ITEM	PLY	BREAKING	DIMENSIONS
BT12	12 ply	26 lbs.	3600' (1097 m) per cone
BT30	30 ply	65 lbs.	1625' (495 m) per cone



Lettuce Koror™ **NEW**

- Tapered teeth allow for clean cuts into lettuce
- Flared grip provides a secure hold for easy insertion and removal
- A wide opening and depth ensures full core removal

ITEM	CUTTING DIAMETER	DIMENSIONS
LK100	2" (51 mm)	3.42"H x 2.7"W (87 x 69 mm)



Lettuce Knife

- Durable nylon material is dishwasher safe
- Serrated edge cuts without "browning" lettuce

ITEM	LENGTH
LK200W	12" (305 mm) including handle



* Specify desired color after item number. Example: 807FBYL



CONDIMENT CENTERS

- Portable, durable condiment serving for a neat, organized countertop
- Enhances image and maximizes efficiency; chillable options available



BD4004
See page 110 for more condiment trays

The Dome® Condiment Center

- Patented, domed lid rotates back for easy access and increased capacity when closed
- Use standard size trays to keep food chilled or deep trays for extra capacity

ITEM	CENTER INCLUDES	CAPACITY
BD4003	(3) 2 qt. (1.9 L), (2) handles	6 qt. (5.6 L)
BD4004	(4) 3 pt. deep trays (1.4 L), (2) handles	6 qt. (5.6 L)
BD4014	(4) 1.5 pt. standard trays (.7 L), (2) handles	3 qt. (2.8 L)

Construction: High-impact resistant plastic



BD2001

Mini Dome® Condiment Centers

- Patented, domed lid design in a smaller size; notched lid option
- Optional connectors provide modularity between Mini Dome®, Dome® and snap-on caddies

ITEM	DESCRIPTION	CAPACITY
EACH MINI DOME® COMES WITH (2) END CAPS		
BD2001	(1) 2 qt. (1.9 L) deep tray	2 qt. (1.9 L)
BD2002	(1) 1 qt. (.95 L) standard tray	1 qt. (.95 L)
BD2003	(2) 1 pt. (0.47 L) standard trays	2 pt. (0.47 L)
BD2002CAR	(1) 1 qt. (.95 L) standard tray (with caddy)	1 qt. (.95 L)
BD2004CAL	(2) 1.5 pt. (0.71 L) deep trays (with left hand caddy)	3 pt. (1.4 L)
BD2004NL	(2) 1.5 pt. (0.71 L) deep trays (notched domed lid)	3 pt. (1.4 L)

Construction: High-impact resistant plastic



Dome® Stacker

- Allows you to customize a configuration using Dome® and Mini Dome® to fit virtually any space
- Makes your operation more efficient, more organized and more professional

ITEM	DESCRIPTION	CAPACITY
BDSX100	Dome® Stacker Conversion Kit - converts your Dome® and Mini Dome® into a versatile, organized garnish center (Dome and Mini Dome not included)	N/A
BDS2203	Dome® Stacker - 1/1 Mini Dome: (4) 1 pt. trays & bonus (2) 2 qt. trays	4 qt. (3.8 L)
BDS2204NL	Dome® Stacker - 1/1 Mini Dome: (4) 1.5 pt. deep trays - notched lids & bonus (2) 2 qt. trays	4.5 qt. (4.25 L)
BDS2401NL	Dome® Stacker - 2/2 Mini Domes: (4) 2 qt. deep Trays	8 qt. (7.6 L)
BDS2483NL	Dome® Stacker - 2/2 Mini Domes: (4) 1.5 pt. deep trays, (4) 1 pt. standard trays, (2) notched lids & (2) standard lids	5 qt. (4.7 L)
BDS4206	Dome® Stacker - 1/1 Dome®: (12) 1 pt. standard trays	6 qt. (5.6 L)
BDS4266	Dome® Stacker - 1/1 Dome®: (3) 2 qt. deep trays, (6) 1 pt. standard trays (chillable)	9 qt. (8.5 L)



BDS2204NL

Construction: High-impact resistant plastic



EZ-Chill™ Self-Service Center

- Flex-Lid System allows multiple lid positions
- Interchangeable food pans; use with EZ-Chill™ Ice Packs for cold-holding
- Stainless steel design is durable for years of use

ITEM	DESCRIPTION	DIMENSIONS
FP8245NL	(4) ½ pans, (4) Notched Flex-Lids, (1) Ice liner (4) EZ-Chill™ packs	8"H x 25½"W x 7½"D (203 x 638 x 194 mm)



Construction: 22-gauge stainless steel

EZ-Chill™ Food Prep Center

- Replaceable, easy-to-clean food trays, use with EZ-Chill™ Ice Packs for cold-holding
- Flex-Lid System allows multiple lid positions
- Stainless steel design is durable for years of use

ITEM	DESCRIPTION	DIMENSIONS
FP9125FL	(3) ½ pans & spoons, (2) ½ pans, (2) Spoons, (2) Tongs, (1) Ice liner, (4) EZ-Chill™ packs	8"H x 12¾"W x 16¼"D (203 x 324 x 413 mm)
FP8244FL	(4) ½ pans, (2) Flex-Lids, (1) Ice liner	8"H x 25½"W x 7½"D (203 x 638 x 194 mm)
FP9248FL	(8) ½ pans, (4) Flex-Lids, (2) Ice liners, (8) EZ-Chill™ packs	8"H x 25¼"W x 16½"D (203 x 641 x 419 mm)



FP8244FL

Construction: 22-gauge stainless steel

EZ-Chill™ Refreezable Ice Packs

- Freeze ahead for up to five hours of chilling
- Easier and cleaner than using ice

ITEM	DESCRIPTION	QUANTITY	DIMENSIONS
B6180	15 oz. Refreezable ice packs	6	6"H x 5"W x 2"D





EZ-Chill™ Condiment Center with Individual Notched Lids

- Transparent, individual notched lids accommodate spoons while protecting condiments from spills and contaminants
- Attractive stainless steel construction for years of use

ITEM	DESCRIPTION	DIMENSIONS
B6183INL	(3) 1 qt. (0.95 L) inserts with notched lids; (1) Ice liner; (3) EZ-Chill™ packs	5 $\frac{7}{8}$ "H x 18"W x 5 $\frac{3}{4}$ "D (149 x 457 x 137 mm)

Construction: 22-gauge stainless steel



EZ-Chill™ Stepped Center with Individual Notched Lids

- Stepped design allows for maximum capacity within easy reach
- Transparent, notched lids easily accommodate spoons and keep condiments protected
- Attractive stainless steel construction for years of use

ITEM	DESCRIPTION	DIMENSIONS
B6706INL	(6) 1 qt. (0.95 L) inserts with notched lids; (2) Ice liners; (6) EZ-Chill™ packs	12 $\frac{5}{8}$ "H x 18"W x 12"D (321 x 457 x 305 mm)

Construction: 22-gauge stainless steel



B4706INL

Stepped Center with Individual Notched Lids

- Transparent, individual notched lids accommodate spoons while protecting condiments from spills and contaminants
- Attractive stainless steel construction for years of use

ITEM	DESCRIPTION	DIMENSIONS
B4702INL	(2) 1 qt. (0.95 L) inserts with individual notched lids	8"H x 6 $\frac{1}{4}$ "W x 12"D (203 x 156 x 305 mm)
B4704INL	(4) 1 qt. (0.95 L) inserts with individual notched lids	8"H x 12"W x 12"D (203 x 305 x 305 mm)
B4706INL	(6) 1 qt. (0.95 L) inserts with individual notched lids	8"H x 18 $\frac{1}{2}$ "W x 12"D (203 x 460 x 305 mm)

Construction: 22-gauge stainless steel



B4122INL

Condiment Center with Individual Notched Lids

- Transparent, individual notched lids accommodate spoons while protecting condiments from spills and contaminants
- Attractive stainless steel construction for years of use

ITEM	DESCRIPTION	DIMENSIONS
B4061INL	(1) 1 qt. (0.95 L) insert with individual notched lids	3 $\frac{1}{2}$ "H x 6"W x 5 $\frac{3}{4}$ "D (89 x 152 x 146 mm)
B4122INL	(2) 1 qt. (0.95 L) inserts with individual notched lids	3 $\frac{1}{2}$ "H x 12"W x 5 $\frac{3}{4}$ "D (89 x 305 x 146 mm)

Construction: 22-gauge stainless steel

PUMP CENTERS

- Dispense liquid condiments, sauces and syrups with ease
- Available in counter-top and in-counter options

FrontLine™ Universal Countertop Box System

- Dispenses from gallon jar, #10 can, Cryovac® bag and direct pour
- Soft-Touch™ pump delivers smooth, effortless dispensing
- Attractive stainless steel construction for years of use

ITEM	COLOR	DIMENSIONS
[1] PUMP BOX WITH TAMPER RESISTANT LID, PUMP, CONDIMENT LINER, CRYOVAC® BAG ADAPTER & PLUG, DIP TUBE.		
P4900	Metal Finish	without pump: 12¼"H x 7½"W x 10"D (311 x 191 x 254 mm) with pump: 21½"H x 7½"W x 12½"D (546 x 191 x 318 mm)
P4900BK	Black	without pump: 12¼"H x 7½"W x 10"D (311 x 191 x 254 mm) with pump: 21½"H x 7½"W x 12½"D (546 x 191 x 318 mm)

Construction: (Box/Lid) 22-gauge stainless steel
(Pump) High-impact plastic



P4900



FrontLine™ Universal In-Counter Condiment System

- Dispenses from gallon jar, #10 can, Cryovac® bag and direct pour
- Soft-Touch™ pump delivers smooth, effortless dispensing
- Attractive stainless steel cover for years of use

ITEM	COLOR	COUNTER HOLE DIAM.	DIMENSIONS
[1] UNIVERSAL CONDIMENT DISPENSER WITH PUMP, TAMPER RESISTANT LID, IN-COUNTER LINER, CRYOVAC® BAG ADAPTER & PLUG, DIP TUBE.			
P4100	Metal Finish	8.5"L x 6.5"W (216 x 165 mm)	without pump: 12"H x 7½"W x 9½"D (305 x 191 x 241 mm) above counter with pump: 9¾"H x 7½"W x 9½"D (248 x 191 x 241 mm)
P4100BK	Black	8.5"L x 6.5"W (216 x 165 mm)	without pump: 12"H x 7½"W x 9½"D (305 x 191 x 241 mm) above counter with pump: 9¾"H x 7½"W x 9½"D (248 x 191 x 241 mm)

Construction: 22-gauge stainless steel; High-impact plastic



P4100



FrontLine™ 7qt. Round Cover & Pump System

ITEM	COLOR	DIMENSIONS
[1] SOFT-TOUCH™ PUMP AND COVER FOR 7-QUART ROUND INSET		
P4710	Metal Finish	Container: 8½"H x 9½"D (206 x 241 mm) with inset container (to be ordered separately)
P4710BK	Black	Container: 8½"H x 9½"D (206 x 241 mm) with inset container (to be ordered separately)
[1] 7 QUART INSERT CONTAINER		
P417	Gray	7-quart round inset container for use with P4710 and P4710BK systems; 9½" (241 mm) diameter; 7 quart (6.65 L) capacity

Construction: (Lid) 22-gauge stainless steel; (Pump) High-impact plastic



P4710

P417



Container is not NSF

P/N	Cryovac® Bag	Gallon Jar	#10 Can	#10 Jar	Direct Pour
P4100	•	•	•	•	•
P4800		•	•	•	•
P4900	•	•	•	•	•

FRONTLINE™ CONDIMENT SYSTEMS

- Most versatile system on the market
- Sleek, low-profile design is durable and reliable
- Ensures smooth, effortless dispensing, and trouble-free maintenance

* Cryovac® is a registered trademark of Cryovac, Inc., a subsidiary of Sealed Air Corporation

Modular FrontLine™ Pump & Accessories **NEW**



MODP4900CC and MODCL100

- Dispenses from gallon jar, #10 can, Cryovac® bag and direct pour
- Portion Cup & Lid Dispensers use EZ-Fit® Technology to dispense cups and lids one-at-a-time
- Soft-Touch™ Pump delivers smooth, effortless dispensing
- Attachable drip tray keeps excess sauce off the countertop

ITEM	DESCRIPTION	DIMENSIONS
MODP4900CL	Includes: P4900, MODCL100, MODBASE, MODTRAY	23"H x 14.01"W x 11.35"D (584 x 356 x 288 mm)
MODP4900CC	Includes: P4900, MODCC100, MODBASE, MODTRAY	23"H x 14.01"W x 11.35"D (584 x 356 x 288 mm)
MODCL100*	Modular Portion Cup & Lid Dispenser	14.42"H x 6.01"W x 11.25"D (366 x 153 x 286 mm)
MODCC100	Modular Portion Cup Dispenser	12.59"H x 6.01"W x 11.25"D (320 x 153 x 286 mm)
MODBASE	Modular FrontLine Pump Base	7.83"H x 8"W x 11.35"D (187 x 203 x 288 mm)
MODTRAY	Modular FrontLine Pump Drip Tray	1.32"H x 7.02"W x 9.11"D (34 x 178 x 231 mm)

MODCC100 & MODCL100 include a 4 pack of gaskets for each cup unit to handle a wide range of cup sizes
 *Portion Cup & Lid Dispensers are designed to work with cups and lids measuring 1.5" - 2.31" (38-59 mm) in rim diameter.
 Construction: High-impact plastic.



P4800

FrontLine™ Countertop Box System

- Soft-Touch™ pump delivers smooth, effortless dispensing
- Dispenses from gallon jar, #10 can and direct pour

ITEM	COLOR	CAPACITY	DIMENSIONS
(1) PUMP BOX WITH TAMPER RESISTANT LID, PUMP AND CONDIMENT LINER			
P4800	Metal Finish	7 qt. (6.6 L)	without pump: 11"H x 7"W x 7"D (279 x 178 x 178 mm) with pump: 20¾"H x 7"W x 7"D (514 x 178 x 178 mm)
P4800BK	Black	7 qt. (6.6 L)	without pump: 11"H x 7"W x 7"D (279 x 178 x 178 mm) with pump: 20¾"H x 7"W x 7"D (514 x 178 x 178 mm)

Construction: 22-gauge stainless steel; High-impact plastic



P/N	Cryovac® Bag	Gallon Jar	#10 Can	#10 Jar	Direct Pour
P4100	•	•	•	•	•
P4800		•	•	•	•
P4900	•	•	•	•	•

FRONTLINE™ CONDIMENT SYSTEMS

- Most versatile system on the market
- Sleek, low-profile design is durable and reliable
- Ensures smooth, effortless dispensing, and trouble-free maintenance

Cryovac® is a registered trademark of Cryovac, Inc., a subsidiary of Sealed Air Corporation

FrontLine™ Countertop Dual Condiment System

- Stepped trays have a capacity of 1 quart (0.95 L) each
- Each pump box dispenses gallon jar, #10 can or direct pour
- Soft-Touch™ pump delivers smooth, effortless dispensing

ITEM	COLOR	DIMENSIONS
[2] PUMP BOX SYSTEMS (EITHER P4800 OR P4800BK) AND [1] STEPPED TRAY B4702INL		
P4826	Metal Finish	without pumps: 11"H x 20½"W x 12"D (279 x 511 x 305 mm) with pumps: 20¼"H x 20½"W x 12"D (514 x 511 x 305 mm)
P4826BK	Black	without pumps: 11"H x 20½"W x 12"D (279 x 511 x 305 mm) with pumps: 20¼"H x 20½"W x 12"D (514 x 511 x 305 mm)

Construction: (Box and Stepped Tray) 22-gauge stainless; (Lid) 22-gauge stainless;
(Pump) High-impact plastic



P4826

FrontLine™ Pumps

- Pumps deliver smooth, effortless dispensing

ITEM	COLOR	DESCRIPTION
P4000BK	Black	Pump Only (for use with FrontLine systems only)
P4000	Metal Finish	Pump Only (for use with FrontLine systems only)

(Pump) High-impact plastic



P4000

P4000BK

EZ-Chill™ Condiment Pump Boxes

- Accommodates 1-gallon (4 liter) jar, or #10 can
- Features ice liner and includes (1) EZ-Chill™ Ice Pack
- Includes label packet for easy identification of condiments

ITEM	DESCRIPTION	DIMENSIONS
[1] PUMP BOX WITH ULTRA PUMP, ICE LINER, LABEL PACKET & EZ-CHILL™ PACKS		
P9800	For 1 gallon jar (includes 12" tube)	17¼"H x 7"W x 7½"D (438 x 178 x 181 mm)
P9810	For #10 can or jar (includes 9" tube)	14½"H x 7"W x 7½"D (267 x 178 x 181 mm)

Construction: 22-gauge stainless steel



P9800



P9724

Self-Service Condiment Center

- High-volume, economical condiment dispensing in attractive stainless steel
- Transparent, individual notched lids accommodate spoons while keeping condiments protected from contaminants
- Ultra Pumps dispense a variety of sauces, dressings and toppings

ITEM	DESCRIPTION	DIMENSIONS
P9724	(4) 1 qt. (0.95 L) inserts with notched lids & (4) spoons (2) 2½ qt. (2.4 L) black jars with Ultra Pumps (1) label packet	14"H x 22½"W x 12½"D (356 x 572 x 308 mm)
P9725	(2) 1 qt. (0.95 L) inserts with notched lids & (2) spoons (2) 2½ qt. (2.4 L) black jars with Ultra Pumps (1) label packet	14"H x 16¾"W x 12½"D (356 x 425 x 308 mm)

Construction: 22-gauge stainless steel



P9715

Condiment Pump Service Centers

- Perfect for self-service areas where portion control is critical
- Ultra Pumps dispense in one ounce portions
- 2½ -quart jars are removable for easy cleaning and refilling

ITEM	DESCRIPTION	DIMENSIONS
P9712	(2) 2½ qt. (2.4 L) black jars with Ultra Pumps	12½"H x 10½"W x 7⅞"D (318 x 257 x 200 mm)
P9713	(3) 2½ qt. (2.4 L) black jars with Ultra Pumps	12½"H x 14"W x 7⅞"D (318 x 356 x 200 mm)
P9715	(5) 2½ qt. (2.4 L) black jars with Ultra Pumps	12½"H x 24"W x 7⅞"D (318 x 610 x 200 mm)

Construction: 22-gauge stainless steel



Pump & Condiment Tray Center

ITEM	DESCRIPTION	DIMENSIONS
P9825	(2) Pump boxes with Ultra Pumps (4) 1 qt. (.95 L) inserts with (4) spoons (1) label packet (2) EZ-Chill™ packs for use with Ultra Pumps	14¾"H x 26⅞"W x 12"D (375 x 664 x 305 mm)
P9826	(2) Pump boxes with Ultra Pumps (2) 1 qt. (.95 L) inserts with (2) spoons (1) label packet (2) EZ-Chill™ packs for use with Ultra Pumps	14¾"H x 20⅞"W x 12"D (375 x 511 x 305 mm)

Construction: 22-gauge stainless steel



Economy Pump & Pump Kit

- Includes 6.5" length tube with each pump
- Pump Kit includes 38, 89 and 110 mm size screw caps and Snap caps in 110 and 160 mm sizes

ITEM	COLOR	DESCRIPTION	QUANTITY
P7300	White	Dispenses 1 oz. (29.6 ml) portions	2 pumps bagged w/ header card
P7300BK	Black	Dispenses 1 oz. (29.6 ml) portions	2 pumps bagged w/ header card
P7310	White	Dispenses 1 oz. (29.6 ml) portions	1 pump & 5 caps bagged w/ header card

Construction: High-impact plastic

P7400

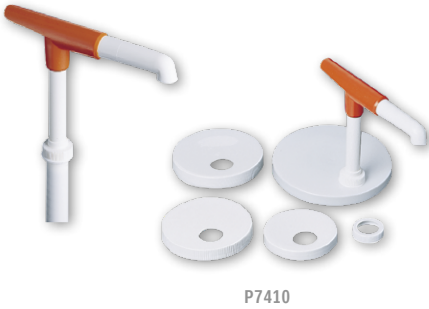

Mega Pump & Pump Kit

- Mega Pump is designed to handle thick and chunky condiments such as tartar sauce, blue cheese dressing and salsa
- Pump Kit includes 38, 89 and 110 mm size screw caps and snap caps in 110 and 160 mm sizes; 4" length tube included with each pump
- Fits Carlisle® Coldmaster Lid CM1033P07

ITEM	DESCRIPTION	QUANTITY
P7400	Dispenses 1 oz. (29.6 ml) portions	2 pumps bagged w/ header card
P7410	Dispenses 1 oz. (29.6 ml) portions	1 pump & 5 caps bagged w/ header card

Construction: High-impact plastic

P7500



Ultra Pump & Pump Kit

- Ultra Pump's fixed nozzle will not move while pumping
- Dispense condiments, sauces, dressings and toppings in one ounce portions
- Kit includes screw caps, and 9" length tube with each pump

ITEM	DESCRIPTION	QUANTITY
P7500	Dispenses 1 oz. (29.6 ml) portions	2 pumps bagged w/ header card
P7510	Dispenses 1 oz. (29.6 ml) portions	1 pump & 5 caps bagged w/ header card

Construction: High-impact plastic



Stainless Steel Syrup Pump

- Easily disassembles for cleaning
- Durable stainless steel construction

ITEM	DESCRIPTION	DIMENSIONS
P8400	For use with the 2½ Quart Fountain Jar (P9700BK)	10 ¹ / ₁₆ "H x 4 ³ / ₁₆ "W x 7"D (257 x 111 x 178 mm)

Construction: 22-gauge stainless steel



Chocolate Pump

- Dispenses thicker chocolate syrups
- Easily disassembles for cleaning
- Durable stainless steel construction

ITEM	DESCRIPTION	DIMENSIONS
P8509	For use with 3½ Quart Fountain Jars	15"H x 4 ³ / ₁₆ "W x 7"D (381 x 111 x 178 mm)

Construction: 22-gauge stainless steel

2½ Quart Fountain Jar

- 2½-quart fountain jar replaces any current jars in San Jamar's Condiment Centers

ITEM	COLOR	DESCRIPTION
P9700BK	Black	For use with the Stainless Steel Syrup Pump (P8400) and Pump Jar Lid (P9770)

Construction: High-impact plastic



Pump Jar Lid

ITEM	DESCRIPTION	QUANTITY
P9770	Designed to fit the fixed nozzle on the Ultra Pump	1 jar lid bagged with header card

Construction: 22-gauge stainless steel



Ice Cream Cone Dispenser

- Easily mounts onto any wall surface
- Includes (3) easy-to-change gaskets for cake, sugar or waffle cones
- Keeps cones fresh and protected from breaking

ITEM	DIMENSIONS
IC2200SM	30½"H x 6"D (772 x 152 mm)

Construction: High-impact plastic



Topping Bar

- Hinged stainless steel lids allow easy access to toppings
- 3 stainless steel ladles included
- Notched jars accommodate ladles and are removable for cleaning and refilling
- Ultra Pumps dispense in one-ounce portions

ITEM	DESCRIPTION	DIMENSIONS
P9723	(2) 2½ qt. (2.4 L) jars with Ultra Pumps (3) 2½ qt. (2.4 L) jars with ladles	12½"H x 22½"W x 12½"D (318 x 610 x 197 mm)

Construction: 22-gauge stainless steel



KITCHEN MANAGEMENT

CHECK MANAGEMENT

FLATWARE MANAGEMENT

FOOD CARRIERS

FLOOR MATTING

CHECK MANAGEMENT

- Durable, long-lasting slide racks for effortless check management



san jamar
smart. safe. sanitary.



CK6512A

Slide Check Racks

- Durable aluminum construction for long life
- Polished glass beads for smooth sliding
- Attractive, sleek design

ITEM	LENGTH	DIMENSIONS
CK6512A	12" (305 mm)	2"H x 12"W x ¾"D (51 x 305 x 19 mm)
CK6518A	18" (458 mm)	2"H x 18"W x ¾"D (51 x 458 x 19 mm)
CK6524A	24" (610 mm)	2"H x 24"W x ¾"D (51 x 610 x 19 mm)
CK6530A	30" (762 mm)	2"H x 30"W x ¾"D (51 x 762 x 19 mm)
CK6536A	36" (915 mm)	2"H x 36"W x ¾"D (51 x 915 x 19 mm)
CK6544A	44" (1118 mm)	2"H x 44"W x ¾"D (51 x 1118 x 19 mm)
CK6548A	48" (1219 mm)	2"H x 48"W x ¾"D (51 x 1219 x 19 mm)
CK6560A	60" (1524 mm)	2"H x 60"W x ¾"D (51 x 1524 x 19 mm)

Construction: Anodized Aluminum; Bagged with header card

FLATWARE MANAGEMENT



KatchAll® Flatware Scrap Block

- Designed for use at dish tables
- Strong magnet attracts discarded flatware
- Fits standard dish table openings from 5½" to 7" (140 mm to 180 mm)
- Dishwasher safe

ITEM	FITS DIMENSIONS
KA600	7¼"D x 4"H (184 x 102 mm)



P9776CL

Condiment Spoons & Tongs

ITEM	DESCRIPTION	VOLUME	QUANTITY
P9776CL	Clear plastic spoons	½ oz. (14.7 ml)	6
P9777CL	Clear plastic tongs	n/a	3

California Residents: Bisphenol A
WARNING (See Appendix A on page 183)



KA4400

KatchAll® Flatware Retrievers

- Strong magnetic bar attracts flatware as it goes into the trash can
- Patented design fits on standard trash cans
- Meets health codes for closed refuse containers and is dishwasher safe

ITEM	DESCRIPTION	DIMENSIONS
FITS CARLISLE® TRIMLINE™ WASTE CONTAINER		
KA1950RD	Burgundy	9"H x 20¾"W x 11¾"D (229 x 518 x 289 mm)
KA1951RD	Burgundy	6¾"H x 20½"W x 11¾"D (165 x 514 x 289 mm)
BURGUNDY, ROUND - FITS CARLISLE® BRONCO™ WASTE CONTAINERS		
KA2000	20 gal. (75.7 L)	20"H x 9½"W (500 x 241 mm)
KA3200	32 gal. (121 L)	22¾"H x 10½"W (565 x 267 mm)
KA3244	32 & 44 gal. (121 & 166.5 L)	25"H x 9½"W (635 x 241 mm)
KA4400	44 gal. (166.5 L)	25"H x 8¾"W (635 x 210 mm)
KA5500	55 gal. (208.2 L)	27"H x 9¾"W (686 x 229 mm)

NOTE: KatchAll Retrievers will not attract 18/8 or 18/10 silverware.

FOOD CARRIERS

- Professional, durable insulated carriers help maintain food quality and temperatures during transport
- Options available for pizza boxes and sheet pans

Insulated Food Carriers

- Features outside identity pocket
- Comfortable padded handles
- Zipper closure

ITEM

FC1212-RD

FC2212-RD

DIMENSIONS

12"H x 12"W x 12"D (305 x 305 x 305 mm)

12"H x 22"W x 12"D (305 x 559 x 305 mm)

Construction: Insulated with 1" foam padding and lined with extra tough, water-repellent nylon



FC1212-RD



FC2212-RD

Insulated Pizza Carriers

- Moisture-free insulation and lining
- Hanging loop for convenient storage option
- Stain-resistant 600 Denier shell

ITEM

PB17

PB20-6

PB20-12

PB25

DESCRIPTION

Holds up to: (4) 12" Pizza Boxes or (3) 14" Pizza Boxes

Holds up to: (3) 16" Pizza Boxes or (3) 18" Pizza Boxes

Holds up to: (6) 16" Pizza Boxes or (6) 18" Pizza Boxes

Holds up to: (2) 24" Pizza Boxes

THICKNESS

3/8"

3/8"

3/8"

3/8"

DIMENSIONS

5"H x 16½"W x 17"D
(127 x 419 x 432 mm)

6"H x 18"W x 20"D
(152 x 457 x 508 mm)

12"H x 18"W x 20"D
(305 x 457 x 508 mm)

6"H x 26"W x 25"D
(152 x 660 x 635 mm)



PB25



PB17

FLOOR MATTING

- Reduce leg fatigue and increase safety
- Available in light to medium-duty for bar, server stations and kitchen applications

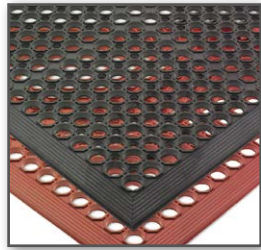

EZ-Mats LIGHT DUTY

- Provide a safe and comfortable walking and standing area for employees
- Engineered for excellent drainage

ITEM	COLOR	DESCRIPTION	DIMENSIONS
KM1100	Black	Non-Bagged	3'L x 5'W x ½"D (91.4 x 152.4 x 1.3 cm)
KM1100B	Black	Bagged	3'L x 5'W x ½"D (91.4 x 152.4 x 1.3 cm)
KM1200	Red	Non-Bagged	3'L x 5'W x ½"D (91.4 x 152.4 x 1.3 cm)
KM1200B	Red	Bagged	3'L x 5'W x ½"D (91.4 x 152.4 x 1.3 cm)



Tuf-Mats MEDIUM DUTY

- Designed for maximum support and durability in high traffic areas
- Circular pattern allows for drainage and easy clean-up
- High grade rubber resists wear and provides excellent traction

ITEM	COLOR	DESCRIPTION	DIMENSIONS
KM2100	Black	Non-Bagged	3'L x 5'W x ¾"D (91.4 x 152.4 x 1.9 cm)
KM2100B	Black	Bagged	3'L x 5'W x ¾"D (91.4 x 152.4 x 1.9 cm)
KM2200B	Red	Bagged	3'L x 5'W x ¾"D (91.4 x 152.4 x 1.9 cm)

Connect-A-Mats LIGHT DUTY

- Connect together for secure floor matting
- Lightweight and easy to move
- Provides excellent foot support

ITEM	COLOR	DESCRIPTION	DIMENSIONS
KM1140B	Black	Bagged	3'L x 3'W x ½"D (91.4 x 91.4 x 1.3 cm)
KM1240B	Red	Bagged	3'L x 3'W x ½"D (91.4 x 91.4 x 1.3 cm)

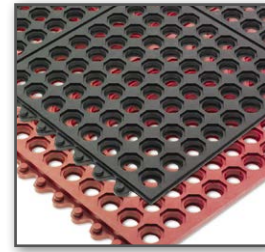

Anti-Fatigue Sponge Vinyl Mats

- Designed for dry areas
- Easy to clean with vacuum or broom
- Lightweight and easy to move

ITEM	COLOR	DESCRIPTION	DIMENSIONS
KM4100BK	Black	Bagged	27"L x 36"W (68.6 x 91.4 cm), 3/8 thickness
KM4360BK	Black	Bagged	3'L x 60'W (91.4 x 1828.8 cm), 3/8 thickness



MEASUREMENT TOOLS

SCALES

SCALE ACCESSORIES

THERMOMETERS

TIMERS

SCALES

- Effectively manage portion control
- Reduce food waste





SlimLine™ Digital Scale **NEW**

- Durable stainless steel platform
- IP65 water resistant front panel
- Touch sensitive front panel

ITEM	CAPACITY	INCREMENTS	DIMENSIONS	ADAPTER/BATTERIES
SCD6SL33	33 lb (15 kg)	0.05 oz (1 g)	1"H x 12.6"W x 10.1"D (25 x 320 x 257 mm)	Adapter: N/A Batteries: 4 AA Included

CE
COMPLIANT

Large Portion Control Digital Scale **NEW**

- 4-in-1 configurations
- Sealed display
- Tare feature and automatic shut off
- Tare Foot Pedal available, see page 140

ITEM	CAPACITY	INCREMENTS	DIMENSIONS	ADAPTER/BATTERIES
SCDGPC13	13 lb (6 kg)	0.1 oz (2 g)	3"H x 12.5"W x 15.75"D (76 x 318 x 400 mm)	Adapter: Included Batteries: N/A



Small Portion Control Digital Scale **NEW**

- 4-in-1 configurations
- Sealed display
- Tare feature and automatic shut off
- Tare Foot Pedal available, see page 140

ITEM	CAPACITY	INCREMENTS	DIMENSIONS	ADAPTER/BATTERIES
SCDGPCM13	13 lb (6 kg)	0.1 oz (1 g)	2.5"H x 6.25"W x 9.5"D (64 x 159 x 241 mm)	Adapter: Included Batteries: N/A



SCDGPC13
Wall Mount Configuration Shown

SCDGPCM13
Arm Mount Configuration Shown

SCDGPCM13
Detached Configuration Shown

SCDGPC13
Attached Configuration Shown

BAR & FOOD MANAGEMENT



Front

Legal For Trade Scale **NEW**

- NTEP certified for trade
- Stores up to 40 programmable prices
- Rechargeable battery



Back

ITEM	CAPACITY	INCREMENTS	DIMENSIONS	ADAPTER/BATTERIES
SCDG30LFT	30 lb (15 kg)	0.01 lb (5 g)	4.25"H x 12.25"W x 13"D (108 x 311 x 330 mm)	Adapter: Included Batteries: Internal 6V



L-Series High Precision Scale **NEW**

- Removable stainless steel platform
- Sealed display
- Tare feature and automatic shut off

ITEM	CAPACITY	INCREMENTS	DIMENSIONS	ADAPTER/BATTERIES
SCDG125GR	4 oz (125 g)	0.001 oz (0.01 g)	2.5"H x 5.75"W x 8"D (64 x 146 x 203 mm)	Adapter: 9VADAP Batteries: 4 AA Included
SCDG600GR	21 oz (600 g)	0.01 oz (0.1 g)	2.5"H x 5.75"W x 8"D (64 x 146 x 203 mm)	Adapter: 9VADAP Batteries: 4 AA Included



SCDG125GR



Industrial Digital Scale **NEW**

- Auto shutoff
- Remote display
- Tare feature

ITEM	CAPACITY	INCREMENTS	DIMENSIONS	ADAPTER/BATTERIES
SCDG264	264 lb (120 kg)	2 oz (0.05 kg)	1.25"H x 11.5"W x 11"D (32 x 292 x 279 mm)	Adapter: Included Batteries: 9V Included



Large Square Kitchen Scale **NEW**

- Sealed display
- Tare feature

ITEM	CAPACITY	INCREMENTS	DIMENSIONS	ADAPTER/BATTERIES
SCDG13	13 lb (6 kg)	0.1 oz (1 g)	3.75"H x 7.25"W x 9.75"D (95 x 184 x 248 mm)	Adapter: 9VADAP Available Batteries: 9V Included



Square Professional Digital Scale **NEW**

- Backlight display
- Parts counting feature
- Display hold

ITEM	CAPACITY	INCREMENTS	DIMENSIONS	ADAPTER/BATTERIES
SCDG33BK	33 lb (15 kg)	0.1 oz (1 g)	3.75"H x 8.5"W x 8.25"D (95 x 216 x 210 mm)	Adapter: 9VADAP Available Batteries: 9V Included





Glass Digital Scale **NEW**

- Smooth glass surface
- Touch screen display
- Tare feature and automatic shut off

ITEM	CAPACITY	INCREMENTS	DIMENSIONS	ADAPTER/BATTERIES
SCDG15BK	15 lb (7 kg)	0.1 oz (1 g)	0.75"H x 6.5"W x 9"D (19 x 165 x 229 mm)	Adapter: N/A Batteries: 1 CR2032 Included



SCDGM33

M-Series Scales **NEW**

- Display hold
- Sealed dual display
- Tare feature and automatic shut off

ITEM	CAPACITY	INCREMENTS	DIMENSIONS	ADAPTER/BATTERIES
SCDGM33	33 lb (15 kg)	0.1 oz (2 g)	4.15"H x 10.25"W x 12"D (105 x 260 x 305 mm)	Adapter: 9VADAP Available Batteries: 4 C Included
SCDGM66	66 lb (30 kg)	0.1 oz (2 g)	4.15"H x 10.25"W x 12"D (105 x 260 x 305 mm)	



SCDGP11BK

Round Professional Digital Scale **NEW**

- Removable stainless steel platform
- Simple 2 button operation
- Tare feature and automatic shut off
- HACCP color-coded replacement platforms available

ITEM	COLOR	CAPACITY	INCREMENTS	DIMENSIONS	ADAPTER/BATTERIES
SCDGP11*	BK, M, RD	11 lb (5 kg)	0.1 oz (1 g)	1.65"H x 6"W x 8.5"D (42 x 152 x 216 mm)	Adapter: 9VADAP Available Batteries: 2 AA Included

COMPATIBLE WITH COLOR CODED SCALE PLATFORMS (PAGE 140)



SCDG11BK

Round Digital Scale **NEW**

- Simple 2 button operation
- Tare feature
- Automatic shut off
- HACCP color-coded replacement platforms available

ITEM	COLOR	CAPACITY	INCREMENTS	DIMENSIONS	ADAPTER/BATTERIES
SCDG11*	BK, M, BLR	11 lb (5 kg)	0.1 oz (1 g)	1.65"H x 6"W x 8.5"D (42 x 152 x 216 mm)	Adapter: N/A Batteries: 2 AA Included

COMPATIBLE WITH COLOR CODED SCALE PLATFORMS (PAGE 140)



Low Profile Digital Scale **NEW**

- Simple 2 button operation
- Sealed display
- Tare feature and automatic shut off
- HACCP color-coded replacement platforms available

ITEM	CAPACITY	INCREMENTS	DIMENSIONS	ADAPTER/BATTERIES
SCDG2LP	2 lb (1 kg)	0.05 oz (0.5 g)	1.5"H x 5.75"W x 8.25"D (38 x 146 x 210 mm)	Adapter: 9VADAP Available Batteries: 2 AA Included
SCDG13LP	13 lb (6 kg)	0.05 oz (0.5 g)	1.5"H x 5.75"W x 8.25"D (38 x 146 x 210 mm)	

COMPATIBLE WITH COLOR CODED SCALE PLATFORMS (PAGE 140)



SCDG2LP



Mechanical Scale with Bowl **NEW**

- Tare feature
- Removable stainless steel bowl
- Shatterproof front panel

ITEM	CAPACITY	INCREMENTS	DIMENSIONS	ADAPTER/BATTERIES
SCDLB2	2 lb (1 kg)	0.25 oz (5 g)	10"H x 8"W x 8.5"D (254 x 203 x 216 mm)	Analog - no batteries required
SCDLB11	11 lb (5 kg)	1 oz (20 g)	10.25"H x 7"W x 9.7"D (260 x 178 x 245 mm)	Analog - no batteries required



SCDLB11

Mechanical Dial Scale **NEW**

- Removable access panel
- Tare feature
- Water-resistant

ITEM	CAPACITY	INCREMENTS	DIMENSIONS	ADAPTER/BATTERIES
SCMDL2	2 lb (32 oz)	1/8 oz	8.5"H x 6.75"W x 6.5"D (216 x 171 x 165 mm)	Analog - no batteries required
SCMDL5	5 lb (80 oz)	1/2 oz	8.5"H x 6.75"W x 6.5"D (216 x 171 x 165 mm)	Analog - no batteries required
SCMDL25	25 lb	2 oz	8.5"H x 6.75"W x 6.5"D (216 x 171 x 165 mm)	Analog - no batteries required
SCMDL50	50 lb	4 oz	8.5"H x 6.75"W x 6.5"D (216 x 171 x 165 mm)	Analog - no batteries required



SCMDL5



Digital Washdown Scale **NEW**

- Memory recall
- Auto-tare feature
- Rechargeable battery adapter included

ITEM	CAPACITY	INCREMENTS	DIMENSIONS	DESCRIPTION
SCDG33WD	33 lb (15 kg)	0.1 oz (1 g)	3.75"H x 8.5"W x 8.25"D (95 x 216 x 210 mm)	IP67 Waterproof design



SCDG33WD



* Specify desired color after item number. Example: SCDG11M



Black



Metallic



Red



Royal Blue

SCALE ACCESSORIES



SCDG11PLTRD
shown on scale



SCDGLPPLTGN
shown on scale

HACCP Color-Coded Scale Platforms **NEW**

- HACCP colored platforms prevent cross-contamination
- Dishwasher safe

ITEM	COLORS	COMPATIBILITY	DIMENSIONS
SCDGLPPLT*	WH, BL, RD, GN, YL, PR	SCDG2LP, SCDG13LP	5.75"H x 5.75"W (146 x 146 mm)
SCDG11PLT*	WH, BL, RD, GN, YL, PR	SCDG11, SCDGP11	5.5"H x 5.5"W (140 x 140 mm)



Tare Foot Pedal **NEW**

- Remotely control tare for SCDGPC13 and SCDGPCM13

ITEM	COMPATIBILITY	DIMENSIONS	CORD LENGTH
FPED	SCDGPC13 SCDGPCM13	1.25"H x 2.5"W x 4"D (32 x 64 x 102 mm)	8' 6" (259 cm)

9V Adapter **NEW**



ITEM	COMPATIBILITY	DIMENSIONS	CORD LENGTH
9VADAP	Works with all scales except: SCDG15BK, SCDGPC13, SCDGPCM13 & SCDGWD66, SCDGL33, SCDG30LFT	2.5"H x 1.5"W x 1.75"D (64 x 38 x 44 mm)	8' 6" (259 cm)

* Specify desired color after item number. Example: SCDGLPPLTYL

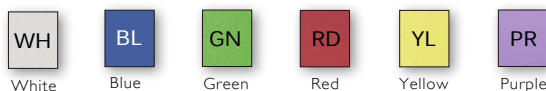

THERMOMETERS

- Ensure safe operating temperatures
- Monitor food and beverage consistency

Folding Digital Thermometer *NEW*

- Folding stainless steel probe
- Target cooking temperatures on handle

ITEM	TEMP RATING	DIMENSIONS	UNITS	DIGITAL/ANALOG
THDGFLD	-49°F to 392°F (-45°C to 200°C)	Probe: 4.6" (117 mm)	Celsius, Fahrenheit	Digital



Waterproof Digital Thermometer *NEW*

- Dishwasher safe
- 1.2 mm thin tip probe
- Display hold function

ITEM	TEMP RATING	DIMENSIONS	UNITS	DIGITAL/ANALOG
THDGWP	-40°F to 450°F (-40°C to 232°C)	Probe: 3" (76 mm)	Celsius, Fahrenheit	Digital



Digital Pen Thermometer *NEW*

- Stainless steel probe
- Sheath doubles as extended handle
- Display hold function

ITEM	TEMP RATING	DIMENSIONS	UNITS	DIGITAL/ANALOG
THDGPN	32°F to 392°F (0°C to 200°C)	Probe: 3" (76 mm)	Celsius, Fahrenheit	Digital



Wireless Remote Thermometer & Timer *NEW*

- Wireless range up to 65 feet (20 m)
- Preset and custom target cooking temperatures
- 40" oven-safe stainless steel mesh cord

ITEM	TEMP RATING	DIMENSIONS	UNITS	DIGITAL/ANALOG
THDGWL	32°F to 482°F (0°C to 250°C)	Probe: 6.5" (165 mm) Display: 4.75"H x 2.9"W x 0.75"D (121 x 74 x 19 mm) Base Antenna: 3.75"H x 2.9"W x 0.75"D (95 x 74 x 19 mm)	Celsius, Fahrenheit	Digital





Touch Screen Thermometer & Timer **NEW**

- Large touch screen display
- 40" oven-safe stainless steel mesh cord
- Custom alert tone
- Magnetic back

ITEM	TEMP RATING	DIMENSIONS	UNITS	DIGITAL/ANALOG
THDGTMTS	-4°F to 482°F (-20°C to 250°C)	Probe: 7.3" (185 mm). Display: 3"H x 3"W x 1"D (76 x 76 x 25 mm)	Celsius, Fahrenheit	Digital



Digital Pocket Thermometer **NEW**

- Anti-roll design
- Stainless steel probe
- Pocket clip

ITEM	TEMP RATING	DIMENSIONS	UNITS	DIGITAL/ANALOG
THDGPCKT	-40°F to 500°F (-40°C to 260°C)	Probe: 4.75" (121 mm)	Celsius, Fahrenheit	Digital



THDGBL

Gourmet Digital Thermometer **NEW**

- Smooth comfort grip handle
- Stainless steel probe
- Sheath and pocket clip

ITEM	COLOR	TEMP RATING	DIMENSIONS	UNITS	DIGITAL/ANALOG
THDG*	BK (Black) BL (Blue)	-49°F to 392°F (-45°C to 200°C)	Probe: 4.75" (121 mm)	Celsius, Fahrenheit	Digital



Digital Probe Thermometer **NEW**

- Oven-safe 40" silicon cord
- Stainless steel probe
- Magnetic and kickstand display

ITEM	TEMP RATING	DIMENSIONS	UNITS	DIGITAL/ANALOG
THDGP	32°F to 392°F (0°C to 200°C)	Probe: 7" (178 mm). Display: 2.25"H x 3.25"W x 0.5"D (57 x 83 x 13 mm)	Celsius, Fahrenheit	Digital



* Specify desired color after item number. Example: THDGBL



Advanced Digital Thermometer **NEW**

- Back light display
- Water-resistant
- Display hold function

ITEM	TEMP RATING	DIMENSIONS	UNITS	DIGITAL/ANALOG
THDGA	-49°F to 392°F (-45°C to 200°C)	Probe: 2.88" (73 mm)	Celsius, Fahrenheit	Digital



Oven Safe Meat Thermometer **NEW**

- Target cooking temperatures on dial face
- Stainless steel probe
- Dishwasher safe

ITEM	TEMP RATING	DIMENSIONS	UNITS	DIGITAL/ANALOG
THDLOSM	140°F to 190°F (60°C to 87°C)	Probe: 4.75" (121 mm) Dial: 2.4" (61 mm)	Celsius, Fahrenheit	Analog



Instant Read Dial Thermometer **NEW**

- Dishwasher safe
- Shatterproof lens

ITEM	TEMP RATING	DIMENSIONS	UNITS	DIGITAL/ANALOG
THDLF	0°F to 220°F	Probe: 5" (127 mm) Dial: 1" (25 mm)	Fahrenheit	Analog
THDLF2 (2 PACK)	0°F to 220°F	Probe: 5" (127 mm) Dial: 1" (25 mm)	Fahrenheit	Analog
THDLC	-10°C to 100°C	Probe: 5" (127 mm) Dial: 1" (25 mm)	Celsius	Analog



THDLC

Instant Read Large Dial Thermometer **NEW**

- Highly-visible analog display
- Shatterproof lens
- Magnified dial

ITEM	TEMP RATING	DIMENSIONS	UNITS	DIGITAL/ANALOG
THDLLD	0°F to 220°F (-10°C to 100°C)	Probe: 5" (127 mm) Dial: 1.75" (44 mm)	Celsius, Fahrenheit	Analog



Instant Read Beverage Thermometer **NEW**



- Dishwasher safe
- Optimal temperature range indicated on dial
- Vessel clip for hands free use

ITEM	TEMP RATING	DIMENSIONS	UNITS	DIGITAL/ANALOG
THDLBEV	0°F to 220°F (-10°C to 100°C)	Probe: 5" (127 mm) Dial: 1.75" (44 mm)	Celsius, Fahrenheit	Analog



Deep Fry/Candy Thermometer **NEW**



- Dishwasher safe
- Stainless steel vessel clip
- Heat-resistant handle

ITEM	TEMP RATING	DIMENSIONS	UNITS	DIGITAL/ANALOG
THDLCDF	100°F to 392°F (40°C to 200°C)	8.5"H x 1.5"W x 0.88"D (216 x 38 x 22 mm)	Celsius, Fahrenheit	Analog



Dial Refrigerator/Freezer Thermometer **NEW**



- Dishwasher safe
- Easy read dial
- Safe operating temps indicated on dial

ITEM	TEMP RATING	DIMENSIONS	UNITS	DIGITAL/ANALOG
THDLRFSS	-20°F to 70°F (-30°C to 20°C)	Dial: 2.9" (74 mm)	Celsius, Fahrenheit	Analog



Mini Refrigerator/Freezer Thermometer **NEW**

- Safe operating temp indicated on display
- Suction cup or hook mounting

ITEM	TEMP RATING	DIMENSIONS	UNITS	DIGITAL/ANALOG	QUANTITY
THDLRFM	-20°F to 100°F (-30°C to 40°C)	3.5"H x 0.75"W x 0.5"D (89 x 19 x 13 mm)	Celsius, Fahrenheit	Analog	20



Refrigerator/Freezer Thermometer **NEW**

- Safe operating temp indicated on display
- Shatterproof lens
- Magnified face

ITEM	TEMP RATING	DIMENSIONS	UNITS	DIGITAL/ANALOG
THDLRFG	-40°F to 80°F (-40°C to 27°C)	1.25"H x 4.75"W x 0.75"D (32 x 121 x 19 mm)	Celsius, Fahrenheit	Analog



Digital Refrigerator/Freezer Thermometer **NEW**

- Large, easy to read display
- Magnetic back
- Kickstand or hanging display

ITEM	TEMP RATING	DIMENSIONS	UNITS	DIGITAL/ANALOG
THDGRF	-4°F to 122°F (-20°C to 50°C)	1.75"H x 2.75"W x 0.5"D (44 x 70 x 13 mm)	Celsius, Fahrenheit	Digital





Oven Thermometer **NEW**

- Oven safe
- HACCP hot food handling temp reminders
- Easy read dial

ITEM	TEMP RATING	DIMENSIONS	UNITS	DIGITAL/ANALOG
THDLOV	40°F to 500°F (10°C to 260°C)	Dial: 2.4" (61 mm)	Celsius, Fahrenheit	Analog



Gourmet Digital Thermometer Countertop Display **NEW**

- Excellent point-of-purchase display
- Each thermometer individually tagged with barcode for easy resale
- Includes 18 Gourmet Digital Thermometers: (6) Black, (4) Red, (3) Blue, (2) Green, (3) Orange

ITEM	TEMP RATING	DIMENSIONS	UNITS	DIGITAL/ANALOG
THDGPK18	-49°F to 392°F (-45°C to 200°C)	Display: 10"H x 6"W x 7.5"D (254 x 152 x 191 mm) Thermometer: 8"H x 0.75"W x 0.5"D (203 x 19 x 13 mm)	Celsius, Fahrenheit	Digital



T-Stick

- Single-use thermometer
- Ensure that your food is perfectly cooked
- Reduces cross-contamination risk



TST9343

ITEM	DESCRIPTION
TST9341	Green 140°F (60°C) Disposable, sanitary thermometer sticks
TST9343	Black 160°F (71°C) Disposable, sanitary thermometer sticks
TST9345	Brown 170°F (77°C) Disposable, sanitary thermometer sticks

TIMERS

- Effectively monitor time/temperature control

Extra Large Display Digital Timer **NEW**

- Counts up & down
- Flashing LED & loud alarm
- Magnetic back

ITEM	MAXIMUM TIME	DIMENSIONS	BATTERIES
TMDGXL	99 minutes, 59 seconds	3.5"H x 3.25"W x 0.75"D (89 x 83 x 19 mm)	Batteries included



Touch Screen Digital Timer **NEW**

- Counts up & down
- Power-saving touch display
- Magnetic back

ITEM	MAXIMUM TIME	DIMENSIONS	BATTERIES
TMDGTS	99 minutes, 59 seconds	3"H x 3"W x 1"D (76 x 76 x 25 mm)	Batteries included



Triple Event Digital Timer **NEW**

- Counts up & down
- Timer, stopwatch & clock
- Magnetic back

ITEM	MAXIMUM TIME	DIMENSIONS	BATTERIES
TMDGTE	19 hours, 59 minutes, 59 seconds	3.75"H x 2.75"W x 0.5"D (95 x 70 x 13 mm)	Batteries included



Mini Digital Timer Countertop Display **NEW**

- Excellent point-of-purchase display
- Each mini timer individually tagged with barcode for easy resale
- Includes 12 Mini Digital Timers: (4) Silver, (2) Red, (2) Blue, (2) Green, (2) Orange

ITEM	MAXIMUM TIME	DIMENSIONS	BATTERIES	QUANTITY
TMDGM12	99 minutes, 59 seconds	Display: 7"H x 6"L x 4.5"D (178 x 152 x 114 mm) Timer: 2.75"H x 2"W x 0.3"D (70 x 51 x 8 mm)	Batteries included	12



PERSONAL SAFETY

Employee safety in the kitchen should always be top-of-mind.

Cuts and burns from exposure to extreme temperatures, cleaning solutions and sharp implements are a constant safety risk. Guard against bodily injuries with San Jamar's comprehensive line of personal protective gear.

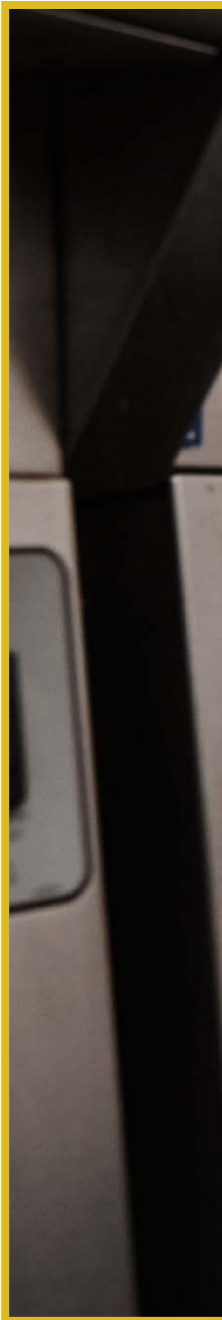

TEMPERATURE
PROTECTION MITTS

TEMPERATURE
PROTECTION
GLOVES & SLEEVES



TEMPERATURE
PROTECTION
HOLDERS

CUT
PROTECTION

CHEMICAL
PROTECTION

TEMPERATURE PROTECTION

HIGH PERFORMANCE

VALUE-ADDED

ECONOMY



MITTS



With
Built-in
magnet

FX17

FlexGuard™ **NEW**

- Pure silicone shell provides high heat & steam protection
- Seamless construction protects against liquids
- Textured surface for excellent grip during tasks

ITEM	LENGTH	COLOR	DESCRIPTION	TEMPERATURE PROTECTION
FX*	15" (381 mm) 17" (432 mm)	Black	Conventional Style	Up to 685°F (363°C) for 45 sec

After dishwashing, invert cotton liner to allow for thorough drying.



PERSONAL SAFETY

* Specify desired length: Example: FX15

HIGH PERFORMANCE

Cool Touch Flame™ Oven Mitt



- Flame-resistant and extra durable due to Nomex® and Kevlar® surface
- Provides flame, heat and steam protection
- Integrated magnet allows for easy storage and immediate availability

ITEM	LENGTH	COLOR	DESCRIPTION	TEMPERATURE PROTECTION
KT0212	13" (330 mm)	Dark Red	Conventional Style	Up to 535°F (280°C) for 30 sec
KT0215	15" (381 mm)	Dark Red	Conventional Style	Up to 535°F (280°C) for 30 sec
KT0218	17" (432 mm)	Dark Red	Conventional Style	Up to 535°F (280°C) for 30 sec
KT0224	24" (610 mm)	Dark Red	Conventional Style	Up to 535°F (280°C) for 30 sec
KT0112K	13" (330 mm)	Dark Red	Puppet Style	Up to 535°F (280°C) for 30 sec
KT0115K	15" (381 mm)	Dark Red	Puppet Style	Up to 535°F (280°C) for 30 sec
KT0118K	17" (432 mm)	Dark Red	Puppet Style	Up to 535°F (280°C) for 30 sec
KT0124K	24" (610 mm)	Dark Red	Puppet Style	Up to 535°F (280°C) for 30 sec



Cool Touch™ Oven Mitt



- Made with Kevlar® WebGuard™ for extra protection
- Provides heat and steam protection
- Integrated magnet allows for easy storage and immediate availability

ITEM	LENGTH	COLOR	DESCRIPTION	TEMPERATURE PROTECTION
CTC*	13" (330 mm)	Red	Conventional Style	Up to 500°F (260°C) for 15 sec
	15" (381 mm)			
	17" (432 mm)			
	24" (610 mm)			
CTP*	13" (330 mm)	Red	Puppet Style	Up to 500°F (260°C) for 15 sec
	15" (381 mm)			
	17" (432 mm)			
	24" (610 mm)			



EZ-Kleen™ Oven Mitt **NEW**

- Removable liner
- Easy to wipe clean; exterior & liner
- Provides heat and steam protection



ITEM	LENGTH	COLOR	DESCRIPTION	TEMPERATURE PROTECTION
EZK15	15" (381 mm)	Red	Conventional Style	Up to 450°F (232°C) for 15 sec
EZK17	17" (432 mm)	Red	Conventional Style	Up to 450°F (232°C) for 15 sec

Oven Mitt with Kevlar®

- Durable, ambidextrous and ideal for handling abrasive items
- Made with fire-resistant Kevlar®
- Machine washable

ITEM	LENGTH	COLOR	DESCRIPTION	TEMPERATURE PROTECTION
KM*	15" (381 mm) 17" (432 mm)	Gold	Conventional Style	Up to 500°F (260°C) for 30 sec



UltiGrips® Oven Mitt

- Non-slip, textured Neoprene material repels stains and provides superior grip ability in hot or cold applications
- WebGuard™ for extra protection & comfort

ITEM	LENGTH	COLOR	DESCRIPTION	TEMPERATURE PROTECTION
UCMX*BK	13" (330 mm) 15" (381 mm) 17" (432 mm)	Black	Conventional Style	-109°F (-78°C) up to 500°F (260°C) for 15 sec
UPM*BK	15" (381 mm) 17" (432 mm)	Black	Puppet Style	-109°F (-78°C) up to 500°F (260°C) for 15 sec



UCMX17BK



BestGrip™ Oven Mitt

- Non-slip, textured Neoprene material repels stains and provides superior grip ability in hot applications
- Rinse in sink or wipe clean with damp cloth

ITEM	LENGTH	COLOR	DESCRIPTION	TEMPERATURE PROTECTION
810CM*	15" (381 mm) 17" (432 mm)	Tan/Black	Conventional Style	-109°F (-78°C) up to 500°F (260°C) for 60 sec
810PM*	15" (381 mm) 17" (432 mm)	Tan/Black	Puppet Style	-109°F (-78°C) up to 500°F (260°C) for 60 sec



810CM17

With Built-in magnet



Terry Oven Mitt

- Made with heavy-duty, institutional grade terry cloth
- Machine washable
- Steam barrier option available

ITEM	LENGTH	COLOR	DESCRIPTION	TEMPERATURE PROTECTION
8*TM	13" (330 mm) 17" (432 mm) 24" (610 mm)	Natural	Conventional Style	Up to 500°F (260°C) for 30 sec
817TM-BR	17" (432 mm)	Brown	Conventional Style	Up to 500°F (260°C) for 30 sec
8*TM-SB	13" (330 mm) 17" (432 mm)	Natural	With Steam Barrier	Up to 500°F (260°C) for 30 sec



813TM

* Specify desired length: Example: CTCI 3

Kevlar® and Nomex® are registered trademarks of DuPont™



BestGuard® Oven Mitt with Kevlar® WebGuard™

- Ambidextrous & fire retardant with steam protection
- WebGuard™ with Kevlar® for extra durability and protection
- Wipes clean with a damp cloth

ITEM	LENGTH	COLOR	DESCRIPTION	TEMPERATURE PROTECTION
800FG*	13" (330 mm)	Tan	Conventional Style	Up to 450°F (232°C) for 30 sec
	15" (381 mm)			
	17" (432 mm)			
	24" (610 mm)			
800FG*-BK	13" (330 mm)	Black	Conventional Style	Up to 450°F (232°C) for 30 sec
	15" (381 mm)			
	17" (432 mm)			
	24" (610 mm)			



Wool Oven Mitt

- 100% cotton exterior with wool insulation
- Machine washable

ITEM	LENGTH	COLOR	DESCRIPTION	TEMPERATURE PROTECTION
OM17-GYW	17" (432 mm)	Gray	Conventional Style	Up to 450°F (232°C) for 30 sec



Bestan® Oven Mitt

- Rinses clean
- Non-stick coating

ITEM	LENGTH	COLOR	DESCRIPTION	TEMPERATURE PROTECTION
811TG*	13" (330 mm)	Tan	Conventional Style	Up to 450°F (232°C) for 15 sec
	15" (381 mm)			
	17" (432 mm)			

Tri-Flex Oven Mitt

- Separate index finger for dial or push button use
- Ambidextrous & fire retardant
- Wipes clean with a damp cloth

ITEM	LENGTH	COLOR	DESCRIPTION	TEMPERATURE PROTECTION
850TF17	17" (432 mm)	Tan	Separate index finger	Up to 400°F (204°C) for 15 sec



CE
COMPLIANT

Silicone Oven/Freezer Mitt

- Rinses clean
- Non-stick coating
- Works well with hot or cold surfaces

ITEM	LENGTH	COLOR	DESCRIPTION	TEMPERATURE PROTECTION
801SG*	13" (330 mm)	Silver	Conventional Style	0°F (-18°C) up to 400°F (204°C) for 15 sec
	15" (381 mm)			
	17" (432 mm)			



* Specify desired length after item number. Example: 800FG13

Kevlar® is a registered trademark of DuPont™

TEMP PROTECTION GLOVES &

HOT OIL GLOVES

TEMPERATURE GLOVES

TEMPERATURE SLEEVES

HOT OIL GLOVES

- San Jamar's hot oil gloves are ideal for restaurant deep fryer grease applications and rotisserie pits
- The cotton flocked inner lining provides ease of slipping gloves on and off



SLEEVES



6786RMT

Fryer Oven Mitt

- Liquid-proof, seamless construction
- Cotton flocked inner lining
- Machine washable

ITEM	LENGTH	MATERIALS	TEMPERATURE PROTECTION
6786RMT	14" (356 mm)	Neoprene rubber	Up to 500°F (260°C) for 15 sec
6786RMT-XL	17" (432 mm)	Neoprene rubber	Up to 500°F (260°C) for 15 sec



T1212

The Rotissi Glove

- Ideal for use in rotisserie pits
- Cotton flocked inner lining

ITEM	LENGTH	MATERIALS	TEMPERATURE PROTECTION
T12*	12" (305 mm) 17" (432 mm)	Neoprene rubber	Up to 500°F (260°C) for 15 sec

* Specify desired length after item number. Example: T1217

TEMPERATURE GLOVES



Hot Mill Knit Glove

- Excellent dexterity
- Knitted wrist for a tighter fit
- Grippy surface

ITEM	SIZE	MATERIALS	TEMPERATURE PROTECTION
ML5000	One size fits most	Heavy duty cotton	Up to 400°F (204°C) for 15 sec



Frozen Food Glove

- Easy on/off
- Non-stick surface
- Great dexterity

ITEM	SIZE	MATERIALS	TEMPERATURE PROTECTION
FGI-OR	One size fits most	PVC with cotton jersey liner	As low as 0°F (-18°C) for 60 sec

California Residents: Di(2-ethylhexyl)phthalate
WARNING (See Appendix B on page 183)



5312-M

White Waiter's Glove

- Fine stitching
- Great dexterity

ITEM	SIZE	DESCRIPTION	MATERIALS
5312WH-*	M, L	Dotted palm for additional grip ability	Cotton
IG100	One size fits most	Clean, upscale look	Cotton

TEMPERATURE SLEEVES

EZ-Kleen™ Sleeve **NEW**

- Easy to wipe clean
- Provides heat and steam protection

ITEM	LENGTH	MATERIALS	TEMPERATURE PROTECTION
EZKSL	16" (406 mm)	Coated Poly-Cotton	Up to 150°F (66°C) for 15 sec



Sleeve with Kevlar®

- Protects forearm against inadvertent heat contact
- Machine washable

ITEM	LENGTH	MATERIALS	TEMPERATURE PROTECTION
SLK16	18" (457 mm)	Kevlar®	Up to 500°F (260°C) for 15 sec

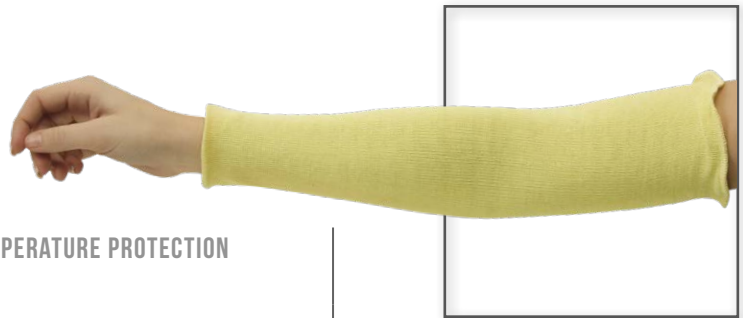

Terry Sleeve

- Knitted wrist
- Heavy-duty institutional grade terry cloth
- Machine washable

ITEM	LENGTH	MATERIALS	TEMPERATURE PROTECTION
SLWT16	18" (457 mm)	100% cotton terry	Up to 350°F (177°C) for 15 sec



* Specify desired size after item number. Example: 5312WH-M

Kevlar® is a registered trademark of DuPont™

TEMPERATURE PROTECTION

POT HOLDERS

PAN GRABBERS

HANDLE HOLDERS

POT HOLDERS



HOLDERS



EZ-Kleen™ Hot Pad **NEW**

- Easy to wipe clean
- Provides heat and steam protection
- Wrist strap for ease of use
- Hanging loop

ITEM	SIZE	MATERIAL	TEMPERATURE PROTECTION
EZKHP88	8" x 8" (203 x 203 mm)	Coated Poly-Cotton	Up to 450°F (232°C) for 15 sec



Cool Touch Flame™ Hot Pads

- Flame, heat, and steam-resistant due to Nomex® surface
- Wrist strap for ease of use
- Machine washable

ITEM	SIZE	MATERIAL	TEMPERATURE PROTECTION
CTFHP88	8" x 8" (203 x 203 mm)	Nomex®	Up to 535°F (280 °C) for 30 sec



UltiGrips® Hot Pads

- Flexible and dishwasher safe
- Provides superior grip ability in hot or cold applications

ITEM	SIZE	MATERIAL	TEMPERATURE PROTECTION
UHP55BK	5.5" x 5.5" (140 x 140 mm)	Non-slip, textured, Neoprene	-109° F (-78° C) up to 500°F (260°C) for 15 sec
UHP77BK	7" x 7" (178 x 178 mm)	Non-slip, textured, Neoprene	-109° F (-78° C) up to 500°F (260°C) for 15 sec
UHP1010BK	10" x 10" (254 x 254 mm)	Non-slip, textured, Neoprene	-109° F (-78° C) up to 500°F (260°C) for 15 sec



BestGuard® Terry Pot Holder

- Hanging loop
- Two sided construction: non-stick BestGuard® on one side, terry on the other

ITEM	SIZE	MATERIAL	TEMPERATURE PROTECTION
802TF	8" x 8" (203 x 203 mm)	BestGuard®/Terry cloth	Up to 500°F (260°C) for 30 sec



Terry Cloth Pot Holder

- Hanging loop
- Machine washable

ITEM	SIZE	MATERIAL	TEMPERATURE PROTECTION
802TPH	8" x 8" (203 x 203 mm)	Heavy-duty terry cloth	Up to 500°F (260°C) for 30 sec

Nomex® is a registered trademark of DuPont™

Silicone Pot Holder

- Non-stick coating
- Wipes clean

ITEM	SIZE	MATERIAL	TEMPERATURE PROTECTION
802SPH	7" x 7" (178 x 178 mm)	Cotton/Silicone	Up to 350°F (177°C) for 15 sec



Round Pot Holder

- Hanging loop
- Machine washable

ITEM	SIZE	MATERIAL	TEMPERATURE PROTECTION
813RPH	8" (203 mm)	Heavy-duty terry cloth	Up to 500°F (260°C) for 30 sec



Bestan® Pot Holder

- Non-stick coating
- Wipes clean

ITEM	SIZE	MATERIAL	TEMPERATURE PROTECTION
812TPH	7" x 7" (178 x 178 mm)	Bestan®/Cotton	Up to 350°F (177°C) for 30 sec



PAN GRABBERS



Pan Grabber (BAKER'S PAD WITH SLIT)

- Convenient wrist slit for easier use
- Easy to use with sheet pans
- Machine washable

ITEM	SIZE	MATERIAL	TEMPERATURE PROTECTION
835PG	10" x 11" (254 x 279 mm)	Terry cloth	Up to 500°F (260°C) for 30 sec



Pan Grabber (BAKER'S PAD)

- Machine washable
- Durable and economical

ITEM	SIZE	MATERIAL	TEMPERATURE PROTECTION
823TPH	10" x 11" (254 x 279 mm)	Terry cloth	Up to 500°F (260°C) for 30 sec



803PG

Pan Grabber (BAKER'S PAD WITH WRIST STRAP)

- Elastic wrist strap
- Customize with your logo
- Machine washable
- Steam protection

ITEM	SIZE	MATERIAL	TEMPERATURE PROTECTION
803PG	9½" x 11" (241 x 279 mm)	Bestex™/Terry cloth	Up to 400°F (204°C) for 15 sec
803PG-LOGO	9½" x 11" (241 x 279 mm)	Bestex™/Terry cloth	Up to 400°F (204°C) for 15 sec

Customization Available: for imprinted version please call customer service for your personalized logo item number



Junior Pan Grabber (BAKER'S PAD WITH POCKET)

- Pouch pocket provides easy on/off
- Machine washable
- Steam protection

ITEM	SIZE	MATERIAL	TEMPERATURE PROTECTION
845PG	6" x 8" (152 x 203 mm)	Cotton/Canvas	Up to 350°F (177°C) for 15 sec

HANDLE HOLDERS

Silicone Handle Holder™ **NEW**

- Contoured for most cast iron pans
- Dishwasher safe
- Hanging hole for easy storage

ITEM	COLOR	SIZE	MATERIAL	TEMPERATURE PROTECTION
806SHH-BK	Black	2" x 5½" (51 x 140 mm)	Silicone	Up to 450°F (232°C) for 15 sec
806SHH-PR	Purple	2" x 5½" (51 x 140 mm)	Silicone	Up to 450°F (232°C) for 15 sec



806SHH-PR



BestGuard® Handle Holder

- Fire retardant coating
- Wipes clean with damp cloth

ITEM	COLOR	SIZE	MATERIAL	TEMPERATURE PROTECTION
804BG	Tan	3¼" x 6½" (83 x 165 mm)	BestGuard®/Cotton	Up to 450°F (232°C) for 15 sec
804BG-BK	Black	3¼" x 6½" (83 x 165 mm)	BestGuard®/Cotton	Up to 450°F (232°C) for 15 sec



804BG

Bestan® Handle Holder

- Non-stick surface
- Wipes clean with damp cloth

ITEM	COLOR	SIZE	MATERIAL	TEMPERATURE PROTECTION
804HH	Tan	3¼" x 6½" (83 x 165 mm)	Bestan®/Cotton	Up to 350°F (177°C) for 15 sec



CUT PROTECTION

SAFETY AIDS

CUT PROTECTION GLOVES

SAFETY AIDS

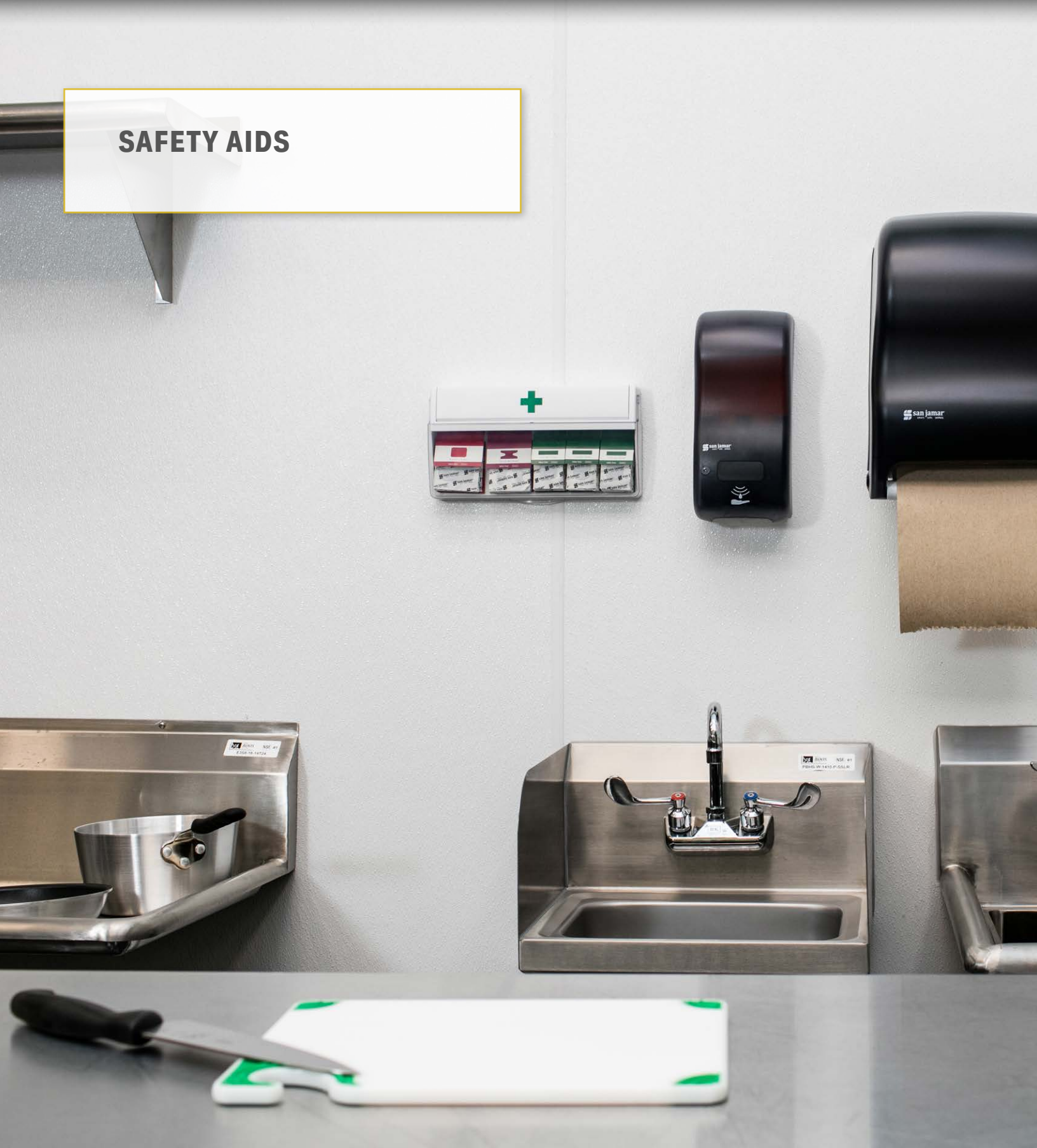



Mani-Kare® Bandage Dispenser **NEW**

- Pilferage-resistant with locked upper compartment
- Simple one-handed operation for ease of use
- One-at-a-time dispensing to reduce waste
- Wall-mounted to save space
- Blue colored, metal detectable bandages to avoid serving contaminated food
- Beige colored bandages also available

ITEM	DESCRIPTION	BANDAGE COLOR	DIMENSIONS
MKBD100	Dispenser with Blue Bandage Cartridges Includes: (1) Large Patch, (1) Knuckle, (3) Strip Bandage cartridges, (1) Quick User Guide, (1) Screw Pack	Blue	6.38"H x 12"W x 2"D (162 x 305 x 51 mm)
MKBD100BE	Dispenser with Beige Bandage Cartridges Includes: (1) Large Patch, (1) Knuckle, (3) Strip Bandage cartridges, (1) Quick User Guide, (1) Screw Pack	Beige	6.38"H x 12"W x 2"D (162 x 305 x 51 mm)
REFILLS			
MKBR901	Blue Strip Bandage (3) cartridges of 15	Blue	1"H x 3"W (25 x 76 mm)
MKBR901BE	Beige Strip Bandage (3) cartridges of 15	Beige	1"H x 3"W (25 x 76 mm)
MKBR903	Blue Knuckle Bandage (3) cartridges of 10	Blue	1.5"H x 3"W (38 x 76 mm)
MKBR903BE	Beige Knuckle Bandage (3) cartridges of 10	Beige	1.5"H x 3"W (38 x 76 mm)
MKBR905	Blue Large Patch Bandage (3) cartridges of 10	Blue	2"H x 3"W (51 x 76 mm)
MKBR905BE	Beige Large Patch Bandage (3) cartridges of 10	Beige	2"H x 3"W (51 x 76 mm)
USER GUIDE			
MKQUG	Mani-Kare Quick User Guide Laminated wall chart	Blue	4"H x 12"W (102 x 305 mm)
MKQUGBE	Mani-Kare Quick User Guide Laminated wall chart	Beige	4"H x 12"W (102 x 305 mm)





Blue bandages are easy to see, so you won't serve contaminated food – a food safety disaster!

Mani-Kare® Bandages

- Latex-free
- Flexible & breathable
- Non-food blue colored bandages are easy to see



MK0909

ITEM	SHAPE	DESCRIPTION	DIMENSIONS	QUANTITY
MK0901		Strip bandages	1"L x 3"W (25 x 76 mm)	300 bandages (6 boxes of 50)
MK0902		Small fingertip bandages	1¾"L x 2"W (44 x 51 mm)	240 bandages (6 boxes of 40)
MK0903		Knuckle bandages	1½"L x 3"W (38 x 76 mm)	240 bandages (6 boxes of 40)
MK0904		Large fingertip bandages	1¾"L x 3"W (44 x 76 mm)	150 bandages (6 boxes of 25)
MK0905		Large Patch bandages	2"L x 3"W (51 x 76 mm)	150 bandages (6 boxes of 25)
MK0906	Assorted	Value pack: 2 boxes of MK0901; 1 box of MK0902; 1 box of MK0903; 1 box of MK0904; 1 box of MK0905	Assorted	100 strips (2 boxes), 40 small fingertips (1 box), 40 knuckles (1 box), 25 large fingertips (1 box) & 25 large patches (1 box)
MK0909	Assorted	1 storage box with 1 MK0906	Assorted	Storage box with 100 strips (2 boxes), 40 small fingertips (1 box), 40 knuckles (1 box) & 25 large fingertips (1 box) & 25 large patches (1 box)

Standard Mani-Kare Bandages are not compatible with MKBD100 or MKBD100BE

BreadGuard™

- Provides a safe and sanitary barrier between one's hand and the food
- Ribbed grips for improved gripping ability
- Provides cut protection

ITEM	COLOR	QUANTITY
BG100	Red	1 each



Bag Boa™ Bag Cutter and Squeegee **NEW**

- Safely opens food bags
- Integrated squeegee eliminates food waste
- High-density plastic with stainless steel safety-type blade

ITEM	DIMENSIONS
BB100	13.5"L x 1.75"W x 0.25"D (330 x 44.5 x 6 mm)

Not intended for use on cardboard cartons. For carton use, please see Klever Kutter™



Klever Kutter™ Carton Opener

- Tough high-density plastic with stainless steel safety-type blades
- No need to change blades
- Prevents costly injuries to employees and damage to products

ITEM	COLOR
KK401	Red
KK401BL	Blue
KK401YL	Yellow
KK403 (RETAIL 3-PACK)	Red



KK401

CUT PROTECTION GLOVES

- Cut-Resistant Gloves are available in many different materials including: Dyneema®- The world's strongest fiber™, Stainless Steel, Nylon Cord, and Natural Rubber
- HACCP food safety colors allow for dedicated use, preventing cross-contamination
- ANSI Level A6 and ANSI Level A7 Cut-Resistant Gloves available
- Wristband color indicates glove size



Cut-Resistant Glove with Dyneema®

WITH EXCLUSIVE DOUBLE GUARD™ ANTIMICROBIAL AGENT

- 10 gauge Dyneema fiber
- Ambidextrous, lightweight & machine washable
- ANSI Level A7 cut protection

ITEM	COLOR	SIZE	LENGTH	MATERIAL	CUT PROTECTION
SG10-*	White	S, M, L, XL	11" (279 mm)	Dyneema composite yarn	Meets OSHA standard (29 CFR) 1910.132 - Tested in accordance with ASTM Spec 177.20
SG10-**	Blue (BL) Green (GN) Red (RD) Yellow (Y) Purple (PR)	S, M, L	11" (279 mm)	Dyneema composite yarn	Meets OSHA standard (29 CFR) 1910.132 - Tested in accordance with ASTM Spec 177.20



* Specify desired size after item number. Example: SG10-S

** Specify desired color and size after item number. Example: SG10-BL-S

Dyneema® is a registered trademark of Royal DSM N.V. under license of Double D Knitting & Glove, Inc.

Stainless Steel Mesh Cut-Resistant Glove

- Non-corrosive & easy to clean
- Antimicrobial wrist strap
- Great for deboning

ITEM	SIZE	MATERIAL
MGA515*	XS, S, M, L, XL	Stainless steel mesh



Cut-Resistant Butcher Glove

WITH EXCLUSIVE DOUBLE GUARD™ ANTI-MICROBIAL AGENT

- 10 gauge yarn
- Ambidextrous, lightweight & machine washable
- ANSI Level A6 cut protection

ITEM	SIZE	MATERIAL	CUT PROTECTION
PBS301-*	XS, S, M, L, XL	Stainless steel/nylon cord	ANSI Level A6 cut protection



D-Shield™ Cut-Resistant Glove

- 10 gauge Dyneema® fiber
- Ambidextrous & machine washable
- ANSI Level A6 cut protection

ITEM	SIZE	MATERIAL	CUT PROTECTION
DFG1000-*	S, M, L, XL	Dyneema®	ANSI Level A6 cut protection



Cut Glove with Kevlar®

- 10 gauge terry cloth and Kevlar fibers
- PVC dot coating for improved grip during tasks
- ANSI level 3 cut protection

ITEM	SIZE	CUT PROTECTION
KG1000	One size fits most	ANSI Level 3 cut protection



Oyster Shucking Glove

- Liquid-proof, cotton lining and easy to clean
- Heavy-duty latex palm coating
- Excellent wet or dry grip

ITEM	SIZE	MATERIAL
1000	One size fits most	Natural rubber latex/cotton



* Specify desired size after item number. Example: MGA515XS
Kevlar® is a registered trademark of DuPont™.

CHEMICAL PROTECTION

APRONS

GLOVES

PROTECTIVE APPAREL

APRONS





EZ-Kleen™ Apron **NEW**

- Easy to wipe clean
- Provides heat and steam protection

ITEM	COLOR	THICKNESS	DIMENSIONS	MATERIAL
EZKAPR	Red	20 mil	25½"W x 36"L (65 x 91 cm)	Coated Poly-Cotton

615NBA-Y



Neo-Flex™ Bib Apron

- Heat-resistant, fire retardant and cut-resistant
- Repels liquid and grease
- Adjustable neck strap

ITEM	COLOR	THICKNESS	DIMENSIONS	MATERIAL
615NBA-*	Y, BK	25 mil	29"W x 43"L (74 x 109 cm)	Neo-Flex™

California Residents: Di(2-ethylhexyl)phthalate
WARNING (See Appendix B on page 183)



Economy Vinyl Bib Apron

- A great look for a very affordable price

ITEM	COLOR	THICKNESS	DIMENSIONS	MATERIAL
604VBA-E	Brown	15 mil	25"W x 28"L (64 x 71 cm)	Vinyl

California Residents: Di(2-ethylhexyl)phthalate
WARNING (See Appendix B on page 183)



614DVA-WH20

20 mil Vinyl Apron

- Protects against fats, liquids and abrasions
- Extra-long ties for added comfort

ITEM	COLOR	THICKNESS	DIMENSION	MATERIAL
614DVA20-GN	Green	20 mil	36"W x 45"L (91 x 114 cm)	Institutional grade quality vinyl
614DVA-WH20	White	20 mil	36"W x 45"L (91 x 114 cm)	Institutional grade quality vinyl

California Residents: Di(2-ethylhexyl)phthalate
WARNING (See Appendix B on page 183)



Heavy Duty Vinyl Apron **NEW**

- Designed for heavy use
- Made in the USA

ITEM	COLOR	THICKNESS	DIMENSION	MATERIAL
5610AP005	Brown	37 mil	25"W x 25.75"L (64 x 65 cm)	Vinyl

California Residents: Di(2-ethylhexyl)phthalate
WARNING (See Appendix B on page 183)

Vinyl Dish Washing Apron

- Includes heavy-duty braided ties

ITEM	COLOR	THICKNESS	DIMENSIONS	MATERIAL
614DVA-WH-**	White	6 mil, 8 mil	36"W x 43"L (91 x 109 cm)	Institutional grade quality vinyl
614DVA-BL	Blue	8 mil	36"W x 43"L (91 x 109 cm)	Institutional grade quality vinyl
614DVA	Clear	12 mil	36"W x 43"L (91 x 109 cm)	Institutional grade quality vinyl

California Residents: Di(2-ethylhexyl)phthalate
WARNING (See Appendix B on page 183)



Vinyl Bib Apron

- Heavyweight
- Waterproof and fire retardant

ITEM	COLOR	THICKNESS	LENGTH	DIMENSIONS	MATERIAL
604VBA-BR	Brown	25 mil	Regular	25"W x 28"L (64 x 71 cm)	Vinyl
604VBA37-BR	Brown	25 mil	Long	25"W x 37"L (64 x 94 cm)	Vinyl

California Residents: Di(2-ethylhexyl)phthalate
WARNING (See Appendix B on page 183)



Disposable Bib Apron

- Lightweight
- Economical
- Durable

ITEM	COLOR	THICKNESS	DIMENSIONS	MATERIAL
8706	White	2 mil	28"W x 46"L (71 x 117 cm)	Polyethylene

* Specify desired color after item number; Example: 615NBA-Y
 ** Specify desired thickness after item number; Example: 614DVA-WH-6



GLOVES



Nitrile Glove

- 22 mil
- Protection against abrasions, punctures and chemicals

ITEM	SIZE	LENGTH	MATERIAL	TEMPERATURE PROTECTION
19NU-*	S, M, L, XL	19" (482 mm)	Nitrile rubber	Protects to 185°F (85°C)

California Residents: Styrene

WARNING (See Appendix C on page 183)



Nitrile Flock Lined Glove

- 15 mil
- Embossed grip
- FDA compliant (21CFR, 170-199)

ITEM	SIZE	LENGTH	MATERIAL	TEMPERATURE PROTECTION
13NU-*	M, L	13" (330 mm)	Nitrile rubber/flock	Up to 195°F (91°C)

California Residents: Styrene

WARNING (See Appendix C on page 183)



Neoprene Flock Lined Glove

- 30 mil, cotton flocked lining & embossed grip
- Resistant to chlorinated solvents, inorganic acids and petroleum products
- FDA compliant (21CFR, 170-199)

ITEM	SIZE	LENGTH	MATERIAL	TEMPERATURE PROTECTION
238SF-*	M, L	15½" (394 mm)	Neoprene	Up to 185°F (85°C)

Latex Flock Lined Glove

- 18 mil
- Embossed grip
- FDA compliant (21CFR, 170-199)

ITEM	SIZE	LENGTH	MATERIAL
620-*	S, M, L, XL	12" (305 mm)	Natural rubber latex



Heavy-Duty Neoprene & Latex Glove

- 28 mil, flock lined and tear-resistant with embossed grip
- Resistant to caustics, alcohols, acids, & detergents
- FDA compliant (21CFR, 170-199)

ITEM	SIZE	MATERIAL
720-*	S, M, L, XL	Neoprene & latex blend



Heavy-Duty Rubber Glove

- 40 mil, unlined with embossed grip
- Resistant to light chemicals

ITEM	SIZE	LENGTH	MATERIAL	TEMPERATURE PROTECTION
R93517	One size fits most	17" (432 mm)	Natural rubber	Up to 185°F (85°C)



* Specify desired size after item number. Example: I3NU-M



ProGrip™

- 45 mil cuff/50 mil palm
- Cut and abrasion-resistant
- FDA compliant (21CFR, 170-199)

ITEM	SIZE	LENGTH	MATERIAL
CP14-*	S, M, L, XL	14" (356 mm)	Nitrile/cotton liner

California Residents: Styrene
WARNING (See Appendix C on page 183)



Neoprene Shoulder-Length Glove

- Liquid Proof
- Full arm protection for chemical or food processing protection
- FDA compliant (21CFR, 170-199)

ITEM	SIZE	LENGTH	MATERIAL	TEMPERATURE PROTECTION
P31	One size fits most	31" (787 mm)	Neoprene	Up to 185°F (85°C)

PVC Glove

- Interior cotton interlock lining
- Rough grip for improved handling
- Oil and chemical-resistant



884

ITEM	SIZE	LENGTH	MATERIAL	TEMPERATURE PROTECTION
884	One size fits most	14" (356 mm)	PVC/Cotton	Up to 185°F (85°C)
887	One size fits most	18" (457 mm)	PVC/Cotton	Up to 185°F (85°C)

California Residents: Di(2-ethylhexyl)phthalate
WARNING (See Appendix B on page 183)



Neoprene Glove

- Liquid proof & steam-resistant
- Jersey-lined for extra heat protection & coated with protective Neoprene rubber
- Heavy duty, launderable, FDA compliant (21 CFR, 170-199)



1217EL

ITEM	SIZE	LENGTH	MATERIAL	TEMPERATURE PROTECTION
1214	One size fits most	14" (356 mm)	Neoprene	Up to 350°F (177°C)
1217EL	One size fits most	17" (432 mm)	Neoprene	Up to 350°F (177°C)



* Specify desired size after item number: Example: CPI4-S

PROTECTIVE APPAREL



EZ-Kleen™ Shin Guards **NEW**

- Easy to wipe clean
- Heat & steam-resistant

ITEM	COLOR	DIMENSIONS	MATERIAL
EZKSHG	Red	12½"W x 23¾"L (32 x 60 cm)	Coated Poly-Cotton



EZ-Kleen™ Face Shield **NEW**

- Easy to wipe clean
- Heat & steam-resistant

ITEM	COLOR	DIMENSIONS	MATERIAL
EZKFS	Yellow	8"W x 15½"L (20 x 39 cm)	Plastic

California Residents: Bisphenol A

WARNING (See Appendix A on page 183)



EZ-Kleen™ Kit **NEW**

Hot grease, boiling water, exposure to dangerous chemicals and vapors are no longer a problem with our new Full Body Protection Kit. The quality construction of every item holds up to the wear and tear of any job.

ITEM	INCLUDES
EZKKIT	2 ea EZK15, 1 ea EZKAPR, 1 pair EZKSHG, 1 ea EZKFS

California Residents: Bisphenol A

WARNING (See Appendix A on page 183)

8*TM	153	B4061INL	120	C52XC	53	C5450C	51
8*TM-SB	153	B4093L	112	C54XC	53	C5450C18	51
9VADAP	140	B4122INL	120	C2010C	52	C5450SM	54
13NU-*	176	B4124L	112	C2210C	52	C6200C	53
19NU-*	176	B4155L	112	C2210C18	52	C6400C	53
238SF-*	176	B4186L	112	C2210CBK	52	C6500C	53
604VBA37-BR	175	B4246L	112	C2210SM	54	C8003WF	50
604VBA-BR	175	B4300	109	C2410C	51	C8003WFS	50
604VBA-E	174	B4702INL	120	C2410C18	51	C8005WF	50
614DVA	175	B4706INL	120	C2410CBK	51	C8005WFS	50
614DVA20-GR	174	B5522	109	C2410SM	54	C8500S	50
614DVA20-WH	174	B5522D	109	C2510C	52	C8503WF	50
614DVA-BL	175	B5532	109	C2802	49	C8503WFD	50
614DVA-WH-**	175	B5532D	109	C2803	49	C8504WF	50
615NBA-*	174	B5542	109	C2804	49	C8504WFD	50
620-*	177	B5542D	109	C2852	48	C9002	49
720-*	177	B5624SG	109	C2853	48	C2400350	52
800FG*	154	B5636SG	109	C2854	48	C2400363	52
800FG*-BK	154	B6180	119	C2901	49	C2400368	52
801SG*	155	B6183INL	120	C2901BK	49	C2400413	52
802SPH	163	B6183L	112	C2902	49	C2400450	52
802TF	162	B6186L	112	C2902BK	49	CB1008	117
802TPH	162	B6706INL	120	C2903	49	CB1218KC	99
803PG	164	B6766L	112	C2903BK	49	CB1218QS	99
803PG-LOGO	164	BB100	116, 169	C2951BK	48	CB1520KC	99
804BG	165	BD100S	111	C2952BK	48	CB1520QS	99
804BG-BK	165	BD101	111	C2953BK	48	CB1824KC	99
804HH	165	BD102	111	C3000EWH	57	CB1824QS	99
807FB*	116	BD103	111	C3000PSS	57	CB6912WH	101, 108
807FBPK	116	BD104	111	C3165*	56	CB12181WH	100
810CM*	153	BD105	111	C3165TBL20	56	CB15201WH	100
810PM*	153	BD106	111	C3200EF	55	CB18241WH	100
811TG*	154	BD110	111	C3200EH	55	CB101212*	99
812TPH	163	BD2001	110, 118	C3200EV	55	CB101212WH	100
813RPH	163	BD2002	110, 118	C3200P	55	CB121812*	99
817TM-BR	153	BD2002CAR	110, 118	C3250SS	56	CB121812GVWH	100
823TPH	164	BD2003	110, 118	C3260*	56	CB121812WH	100
835PG	164	BD2004CAL	110, 118	C3400EF	55	CB121834*	99
845PG	164	BD2004NL	110, 118	C3400EH	55	CB121834WH	100
850TF17	155	BD4003	110, 118	C3400EV	55	CB152012*	99
884	178	BD4004	110, 118	C3400P	55	CB152012GVWH	100
887	178	BD4005E	110	C3450SS	56	CB152012WH	100
1000	171	BD4005S	110	C3500EF	55	CB152034WH	100
1214	178	BD4006S	110	C3500EH	55	CB182412*	99
1217EL	178	BD4014	110, 118	C3500EV	55	CB182412GVWH	100
5312WH-*	158	BD4023S	110	C3500P	55	CB182412WH	100
5610AP005	174	BDRX400	111	C3604	50	CB182434*	99
6786RMT	157	BDS2203	111, 119	C3620	50	CB182434GVWH	100
6786RMT-XL	157	BDS2204NL	111, 119	C4150SS	56	CB182434WH	100
8706	175	BDS2401NL	111, 119	C4160*	56	CB183012WH	100
1178902	103	BDS2483NL	111, 119	C4180*	56	CB183034WH	100
1179944	103	BDS4206	111, 119	C4200PF	57	CB242412WH	100
A		BDS4266	111, 119	C4210PFSD	57	CB242434WH	100
ASZ121812SYS	74, 89	BDSX100	111, 119	C4210PRD	57	CBB6*	103
ASZTHERMW	74, 89	BG100	169	C4400PF	57	CBB6PR	76
B		BM1018	108	C4410PFSD	57	CBCWLTST	95, 103
B400BK	109	BT12	117	C4410PRD	57	CBG912*	97
B416	112	BT30	117	C4500PF	57	CBG912PR	77
B432	112	C		C5250C	51	CBG1218KC	98
B500	109	C22XC	53	C5250C18	51	CBG1520KC	98
		C24XC	53	C5250SM	54	CBG1824KC	98

CBG6938*	97, 98, 108
CBG6938PR	77
CBG121812*	97
CBG121812PR	77
CBG152012*	97
CBG152012PR	77
CBG182412*	97
CBGW912*	98
CBGW912QS	98
CBGW152012*	98
CBGW152012QS	98
CBL601201	102
CBL6012012	102
CBL6012034	102
CBM1016	103
CBM1318	103
CBM1622	103
CBMASZ1212	73, 89
CBMASZ2430	73, 89
CI7001*	87
CI7002*	87
CI7003*	87
CI7004*	87
CI7015*	87
CI7016H	87
CI7016NL	87
CI7016P	87
CI7025	87
CI7111L	87
CI7111NL	87
CI7113L	87
CI7114L	87
CK6512A	129
CK6518A	129
CK6524A	129
CK6530A	129
CK6536A	129
CK6544A	129
CK6548A	129
CK6560A	129
CNCRK	103
CP14*	178
CSD100	66
CTC*	152
CTFHP88	162
CTP*	152
D	
DFG1000*	171
E	
ETW4222*	69
ETW4232*	69
ETW4636*	69
EZK15	152
EZK17	152
EZKAPR	173
EZKFS	179
EZKHP88	161
EZKKIT	179
EZKSHG	179
EZKSL	159

F	
FC1212-RD	131
FC2212-RD	131
FGI-OR	158
FK1000	94
FP8244FL	119
FP8245NL	119
FP9125FL	119
FP9248FL	119
FPED	140
FX*	151
G	
G-10	116
G-10-R	116
G-40	116
G-40-R	116
G-80	116
G0801	33
G0802	33
G0803	33
G0804	33
G0805	33
H	
H400CTBK	45
H900*	45
H985*	45
H2000*	44
H2000SS12	44
H2001*	44
H2001CLSS12	44
H2001SS12	44
H2003CLBK	44, 59
H2003CLBK12	44
H2003CLSC	44, 59
H2003CLSS	44
H2003CLSS12	44
H2005CLBK	44, 59
H2005CLSC	44
H2005CLSS	44
H2005SC	44
H3001*	43
H3005CLXC	43
H4000	45
H4000TBK	45
H4001XC	45
H4003TBK	45
H4004TBK	45
H4005CTBK	45
H4005TBK	45
H4006TBK	45
H5000*	42
H5000P*	43
H5000S*	42
H5003*	42
H5003P*	43
H5004*	42
H5004P*	43
H5005*	42
H5005P*	43

H5005S*	42
HACCPKIT	95
HWWLCT	95
I	
IC2200SM	127
IG100	158
K	
KA600	130
KA1950RD	130
KA1951RD	130
KA2000	130
KA3200	130
KA3244	130
KA4400	130
KA5500	130
KG1000	171
KK401	169
KK401BL	169
KK401YL	169
KK403	169
KLC28C	94
KLP200	107
KLP250	107
KLRST	103
KM15	153
KM17	153
KM1100	132
KM1100B	132
KM1140B	133
KM1200	132
KM1200B	132
KM1240B	133
KM2100	132
KM2100B	132
KM2200B	132
KM4100BK	133
KM4360BK	133
KP97*	92
KP196*	92
KP196KCB	92
KP196KCGN	92
KP196KCRD	92
KP196KCYL	92
KP196PR	75
KP256*	92
KP320*	92
KP320WH	93
KP500	93
KP550GN	93
KPP97*	91
KPP196*	91
KPP256*	91
KPPS97	91
KPPS97WM	91
KPPS196	91
KPPs196WM	91
KPPS256	91
KPPS256WM	91
KPS97	92
KPS97WM	92

KPS196	92
KPS196WM	92
KPS256WM	92
KT0112K	152
KT0115K	152
KT0118K	152
KT0124K	152
KT0212	152
KT0215	152
KT0218	152
KT0224	152
L	
L22C2951BK	47
L22CS2951BK	47
L24C2951BK	47
L320C	59
L360C	67
L1014	60
L1022	60
L1035	112
L2100	66
L2150	66
L2200C	58
L2202	58
L2203	58
L2204	58
L2400C	58
L2900	67
L2910BK	58
L2912BK	58
L2913BK	58
L2920BK	58
L2923BK	58
L3200	60
L3400	60
L3402	60
L3500	60
L3502	60
LK100	117
LK200W	117
M	
MGA515*	171
MK0901	168
MK0902	168
MK0903	168
MK0904	168
MK0906	168
MK0909	168
MKBD100	167
MKBD100BE	167
MKBR901	167
MKBR901BE	167
MKBR903	167
MKBR903BE	167
MKBR905	167
MKBR905BE	167
MKqug	167
MKqugBE	167
ML5000	158
MODBASE	65, 122

MODBD2002.....	64	P9712.....	124	RP15.....	117	SHF970*.....	31
MODBD2002KIT.....	64	P9713.....	124	RP18.....	117	SI2000.....	81
MODBD20021.....	64	P9715.....	124	RW107 80 1228.....	36	SI2000BK.....	81
ModBFD.....	64	P9723.....	127	RW107 80 1230.....	36	SI4550.....	81
MODCC100.....	65, 122	P9724.....	124	RW107 80 1231.....	36	SI5000.....	82
MODCL100.....	65, 122	P9725.....	124	RW107 80 1232.....	36	SI5500.....	82
MODGH100.....	66	P9770.....	127	RW107 80 1234.....	36	SI6000.....	79
MODH6003OGN.....	41, 65	P9776CL.....	130	RW107 80 1235.....	36	SI6000BPAF.....	80
MODH6003SN.....	41, 65	P9777CL.....	130	RW107 80 1255.....	36	SI6100.....	79
MODH6005OGN.....	41, 65	P9800.....	123	S		SI6500.....	79, 80
MODH6005SN.....	41, 65	P9810.....	123	S30*.....	32	SI7000.....	82
MODL2900KIT.....	63	P9825.....	125	S46*.....	32	SI7000BG.....	108
MODL29001.....	63	P9826.....	125	S890*.....	32	SI7500.....	82
MODL29002.....	63	PB17.....	131	S900*.....	31	SI7700.....	82
MODMP16.....	64	PB20-6.....	131	S970*.....	31	SI7750.....	82
ModMP16Kit.....	64	PB20-12.....	131	S1300*.....	31	SI7800.....	82
MODMP161.....	64	PB25.....	131	SCDG2LP.....	139	SI7850.....	82
MODP4900CC.....	65, 122	PBS301-*.....	171	SCDG11*.....	138	SI8500.....	80
MODP4900CL.....	65, 122	PCL2.....	61	SCDG11PLT*.....	140	SI9000.....	83
MODTRAY.....	65, 122	PCL3ADJ.....	61	SCDG11PLTPR.....	76	SI9000SAM.....	83
MP12.....	115	PL010*.....	113	SCDG13.....	137	SI9500.....	83
MP13.....	115	PL040*.....	113	SCDG13LP.....	139	SICART60.....	79
MP14.....	115	PPP60.....	108	SCDG15BK.....	138	SICART61.....	79
MP16.....	115	Q		SCDG30LFT.....	136	SILD6000.....	81
MP19.....	115	QSWLCT.....	95, 103	SCDG33BK.....	137	SLK16.....	159
MPL12PR.....	75, 115	R		SCDG33WD.....	139	SLWT16.....	159
MPL13PR.....	75, 115	R200XC.....	27	SCDG125GR.....	137	ST250.....	59
MPL14PR.....	75, 115	R260XC.....	27	SCDG264.....	137	ST250WM.....	59
MPL16PR.....	75, 115	R1200XC.....	27	SCDG600GR.....	137	ST500.....	59
MPL19PR.....	75, 115	R1500*.....	26	SCDGLPPLT*.....	140	STK1006.....	74, 89
O		R2000*.....	29	SCDGLPPLTPR.....	76	STK1006GRL.....	89
OM17-GYW.....	154	R2070*.....	29	SCDGM33.....	138	STK1006PRL.....	74, 89
P		R2090*.....	29	SCDGM66.....	138	STK1006RDL.....	89
P31.....	178	R3000*.....	28	SCDGP11*.....	138	STK1006YLL.....	89
P417.....	121, 123	R3090*.....	28	SCDGPC13.....	136	STK1008.....	89
P4000BK.....	123	R3500*.....	26	SCDGPCM13.....	136	STL511.....	88
P4100.....	121	R3590*.....	26	SCDGSL33.....	135	SW12.....	88
P4100BK.....	121	R3600*.....	25	SCDLB2.....	139	SW18.....	88
P4710.....	121	R3670*.....	25	SCDLB11.....	139	SW1218.....	88
P4710BK.....	121	R3690*.....	25	SCMDL2.....	139	SW1218SC.....	88
P4800.....	122	R3800*.....	26	SCMDL5.....	139	SWX100.....	88
P4800BK.....	122	R4000*.....	28	SCMDL25.....	139	T	
P4826.....	123	R4070*.....	28	SCMDL50.....	139	T12*.....	157
P4826BK.....	123	R4090*.....	28	SERVSAFEBOOK.....	95	T400*.....	17
P4900.....	121	R5000*.....	28	SF30*.....	32	T410*.....	17
P4900BK.....	121	R6000*.....	29	SF900*.....	31	T450*.....	17
P7300.....	125	R6500*.....	29	SF970*.....	31	T451XC.....	17
P7300BK.....	125	R93517.....	177	SF1300*.....	31	T800WH.....	19
P7310.....	125	RCU64.....	86	SFC1200CL.....	94	T850*.....	19
P7400.....	126	RCU64V2.....	85	SFC1200QT.....	94	T950*.....	18
P7410.....	126	RCU64V2RD.....	85	SFC1250CL.....	94	T970*.....	18
P7500.....	126	RCU128.....	86	SFC1250QT.....	94	T990*.....	18
P7510.....	126	RCU128V2.....	85	SFCROLLCL.....	94	T1100*.....	18
P8004.....	116	RCU128V2RD.....	85	SFCROLLQT.....	94	T1190*.....	18
P8008.....	116	RCU256.....	86	SG10-*.....	170	T1300*.....	15
P8012.....	116	RCU642.....	86	SG10-**.....	170	T1370*.....	15
P8024.....	116	RCU1282.....	86	SG10-PR*.....	77	T1370BKBKCLAI.....	15
P8400.....	126	RCU1282.....	86	SH900*.....	31	T1370WHCLAI.....	15
P8509.....	126	RCUBRKT.....	86	SH970*.....	31	T1390*.....	15
P9700BK.....	127	RCUCAPPAK.....	86	SHF900*.....	31	T1400*.....	14
		RCUWLCT.....	86, 95				

T1400TBKHW*	14	T8408SSUNV	16	THDLC.....	143	UL540*.....	113
T1470*.....	14	T8490*.....	14	THDLCDF.....	144	UPM15BK.....	153
T1490*.....	14	TC7501	101	THDLF.....	143	UPM17BK.....	153
T1700*.....	21	TC7502	101	THDLF2.....	143	V	
T1720*.....	21	TC7503	101	THDLLD	143	VM5180BK.....	113
T1730TBK.....	32	TC121812.....	101	THDLOSM	143	VM5280*.....	113
T1740*.....	21	TC121812GV	101	THDLOV	146	VM5280*-12.....	113
T1750*.....	20	TC152012.....	101	THDLRFG	145	W	
T1755*.....	20	TC152012GV	101	THDLRFM.....	145	WD1010*	33
T1759*.....	20	TC182412.....	101	THDLRFSS.....	144	WP107 80 1202.....	35
T1770*.....	20	TC182412GV	101	TMDGM12	147	WP107 80 1203.....	35
T1790*.....	21	TC481201	102	TMDGTE	147	WP1202MB	36
T1800*.....	23	TC4812012.....	102	TMDGTS	147	WP1202TW	36
T1900*.....	22	TC4812014.....	102	TMDGXL	147	WP9070*.....	35
T1905*.....	22	TC4812034.....	102	TS510*.....	33	X	
T1950XC.....	23	THDG*.....	142	TST9341	146	X101924	50
T7400*.....	13	THDGA	143	TST9343	146	X101987	50
T7470*.....	13	THDGLD.....	141	TST9345	146	XC2022	52
T7490*.....	13	THDGP	142	U		XC2226	52
T8000*.....	16	THDGPKCT	142	UCMX13BK	153	XC2226BK	52
T8006BKADA.....	16	THDGPK18.....	146	UCMX15BK	153	XC2426	52
T8008BKUNV	16	THDGPN.....	141	UCMX17BK	153	XC2426BK	52
T8090*.....	16	THDGRF	145	UHP55BK	162	XC2526	52
T8300TBK.....	15	THDGTMTS	142	UHP77BK	162	XT800SS.....	16
T8370*.....	15	THDGWL	141	UHP1010BK.....	162		
T8400*.....	14	THDGWP	141	UL510*.....	113		
T8406SSADA.....	16	THDLBEV	144				

APPENDIX A, B, C

Appendix A:

WARNING: This product can expose you to chemicals including Bisphenol A, which is known to the state of California to cause birth defects or other reproductive harm. For more information go to www.P65Warnings.ca.gov.

Appendix B:

WARNING: This product can expose you to chemicals including Di(2-ethylhexyl)phthalate, which is known to the state of California to cause cancer and birth defects or other reproductive harm. For more information go to www.P65Warnings.ca.gov.

Appendix C:

WARNING: This product can expose you to chemicals including Styrene, which is known to the state of California to cause cancer and birth defects or other reproductive harm. For more information go to www.P65Warnings.ca.gov.

1. Terms and Method of Payment

- a. All orders are subject to approval and acceptance by SELLER. No order accepted by SELLER shall be subject to cancellation, termination, suspension, change, reduction, cutback or other modification except with SELLER'S prior written consent.
- b. Our standard terms of payment are net 30 days from invoice date. The amount of terms of credit, if extended, may be changed or credit withdrawn by SELLER at any time. No orders will be shipped on a COD basis.
- c. Prices do not include federal, state or local taxes, duties or other levies, now or hereafter enacted, applicable to the items deliverable under the sales order or invoice (hereinafter called ITEMS), which taxes, duties, or other levies will be added by SELLER to the sales price and will be paid by BUYER unless BUYER provides SELLER with a proper exemption certificate.
- d. Packaging for commercial shipment is included in the contract price. Any special packaging, crating or shipping instructions must be noted on BUYER'S original order and acknowledged by SELLER.

2. Title and Delivery

The ITEMS shall be delivered F. O. B. SELLER'S plant, and title thereto shall pass to BUYER, upon SELLER'S delivery of the ITEMS to a common carrier for shipment to BUYER. All items from the San Jamar catalog may be combined to obtain prepaid freight, regardless of the shipping point. Freight is prepaid on all orders totaling \$2,000 net or more to one destination within the contiguous 48 United States. Freight on prepaid International Shipments will be paid on normal ground transportation from shipping point to the consignee. When the order qualifies for prepaid freight, Seller shall have the right to select the means of transportation. If Buyer requires a means of transportation other than the one normally selected by Seller, any extra cost incurred by reason of using such other means shall be paid by Buyer. Palletized international orders requiring heat treated pallets will be charged \$4.25 net per pallet. International orders requiring heat treated certified bark-free pallets will be charged \$18.50 net per pallet. Any accessorial charges incurred because of a customer request will be the responsibility of the requester. Any items backordered from a prepaid shipment will be forwarded prepaid. Items backordered from ex works shipments will be forwarded ex works.

3. Inspection and Acceptance

Thoroughly inspect all shipments. Do not accept a damaged or short shipment until exception is noted on the freight bill. BUYER will be held responsible for all shipments with freight bills signed free and clear. If concealed damage is discovered, contact the freight company immediately for inspection. Concealed damage must be reported to the carrier within 7 days of receipt. All damaged goods and shortages that are not properly documented and reported upon receipt become the sole responsibility of the BUYER.

4. Patent Indemnification

SELLER shall protect and indemnify BUYER and its directors, officers, agents and employees against all claims for damages or profits, including all reasonable costs incurred by BUYER in connection therewith, arising from infringement of patents, copyrights, trademarks or misappropriation of designs.

5. Returns and Cancellations

No returns will be accepted without an authorization number from Carlisle Customer Service. An authorization number may be obtained by calling 800 248 9826 and requesting a Return Authorization from Customer Service. All requests for return must occur within 90 days of the original shipment of the product unless special authorization is obtained. Merchandise returned without authorization will be refused and returned to the customer, freight collect.

Any merchandise must be returned freight prepaid, and is subject to a minimum of 20% restocking charge.

All returned goods must reference the original invoice and purchase order. Returned goods must be in original standard packs and in unused salable condition. Special Order Products and discontinued items will not be accepted for exchange or return.

This includes any articles custom imprinted or modified for purchaser.

6. General

- a. All prices are list and subject to change without notice. Orders from authorized accounts will be accepted with the understanding that prices are those in effect at the time of shipment. These prices are exclusive of all sales taxes which may be levied by State, Federal, or City governments.
- b. Orders less than \$100.00 net will be charged a \$10.00 handling fee. The initial order requirement for a new customer is \$2,000 net, and must be accompanied by a tax exemption certificate.
- c. Orders calling for less than a standard case pack will be charged \$5.00 net each per broken case.
- d. Orders requiring 3rd party freight billing will be accessed a \$5.00 per order processing charge. .
- e. No ITEMS to be furnished hereunder shall be exported by BUYER unless SELLER is first notified in writing of the intention to so export and all applicable regulations and licenses are complied with and obtained by BUYER or its customer.
- f. SELLER hereby certifies that the goods described herein of its manufacture will be produced in compliance with all applicable requirements of Sections 6, 7 and 12 of the Fair Labor Standards Act, as amended, and all order of the United States Department of Labor issued under Section 14 thereof. SELLER further certifies that it is in compliance with the Equal Employment Opportunity clause in Section 202, paragraphs 1 through 7 of Executive Order 11246, as amended, relative to equal employment opportunity and the implementing Rules and Regulations of the Office of Federal Contract Compliance.
- g. SELLER is not responsible for typographical errors made in any of its publications or for stenographic or clerical errors made in preparation of quotations, sales orders, acknowledgments, or invoices. All such errors are subject to correction.
- h. This agreement shall be governed by the laws of the state of Wisconsin.
- i. SELLER'S "Terms and Conditions" as set forth above shall govern all transactions. Any inconsistent terms of BUYER wherever set forth and whether oral or written, shall not be binding upon SELLER unless agreed to by SELLER in writing. No waiver or exception to any of the hereinabove enumerated conditions or any of the special terms and provisions relating to any order shall be binding upon SELLER unless agreed to in writing by SELLER.
- j. SELLER reserves the right to change or discontinue the color, design, component content or price of any ITEMS in SELLER'S catalog or published price lists without prior notice at any time.

The specifications and prices listed in this document are subject to change. San Jamar does not assume responsibility for typographical errors.

Limited Warranty – San Jamar warrants to the original purchaser of each new product of its manufacture for a period of one (1) year from the date of shipment, (or if shorter, the period of the product’s normal useful life) that all parts shall be free from defects in material and workmanship under normal use and service.

The warranties defined herein shall not apply to any damage or defects created or arising from accident, misapplication, abuse, misuse, neglect, alteration, acts of God, vandalism, flood, fire or any other occurrences beyond the control of San Jamar.

Claims under the foregoing warranty will be honored only if San Jamar (i) has received the entire payment of the purchase price for the product with respect to which any such claim is made (ii) has received notification of the claim prior to the expiration of the one (1) year (or shorter) warranty period described above, and (iii) determines upon examination of the returned product that it is defective under the terms of such warranty.

San Jamar’s sole obligation under the foregoing warranty and other claims related to any product shall be limited to, at San Jamar’s option (i) repairing or (ii) replacing F.O.B. factory or any product which San Jamar determines is defective under the terms of such warranty.

THE FOREGOING WARRANTY AND REMEDIES ARE EXCLUSIVE AND IN LIEU OF ANY OTHER WARRANTIES AND REMEDIES WHATSOEVER, EXPRESSED OR IMPLIED, INCLUDING BUT NOT LIMITED TO ANY IMPLIED WARRANTIES OF MERCHANTABILITY OR FITNESS FOR PARTICULAR PURPOSE, ALL OF WHICH SAN JAMAR HEREBY EXPRESSLY DISCLAIMS.

Return Policy – Product returned to San Jamar must have a Returned Goods Authorization (RGA) number from the Customer Care Department. It will be the customer’s responsibility to cover freight charges, and a 20% Restocking Charge will be applicable to all returned product. To receive credit for returned goods, they must be returned in unopened cartons, be less than 90 days from date of invoice and not be an obsolete or phased out product, labeled with the RGA number, and returned within 30 days of the RGA being issued. Returns consistent with these parameters may be made at any time between January 1st and November 30th of any calendar year. No returns will be accepted in the month of December. Credit will be determined upon receipt and inspection of product. Any shipping discrepancies (i.e. shortages, damage, etc.) must be reported to the Customer Care department within 10 business days of receipt of product. Should you have any questions, please contact Customer Care at 800-248-9826 or orders@sanjamar.com.

SMART

SAFE

SANITARY

San Jamar

555 Koopman Lane
Elkhorn, Wisconsin 53121
USA
T: +1.262.723.6133
F: +1.262.226.8664
info@sanjamar.com
www.sanjamar.com

Canada

3280 Bloor Street West
Suite 1140
11th Floor, Centre Tower
Toronto, ON M8X 2X3
CANADA
T: +1.262.723.6133
F: +1.262.226.8664
canada@sanjamar.com

Europe

Schoorstraat 26a, bus 1
2220 Heist-op-den-Berg
BELGIUM
T: +32 15 22 81 40
F: +32 15 22 81 48
emea@sanjamar.com

México

Av. Paseo de la Reforma No. 350 - 10
Col. Juárez
Deleg. Cuauhtemoc, CP 06600
MEXICO, D.F.
T: +52 (55) 3626 0772
mexico@sanjamar.com