



RELIABILITY BUILT IN™

T&S BRASS

G-12
PRODUCT
CATALOG





The Alliance For Water Efficiency is a national nonprofit organization that advocates for water efficiency and conservation among its diverse membership.



T&S is a member of the U.S. Green Building Council (USGBC), an independent accrediting body that has developed a rating system, the Leadership in Energy and Environmental Design (LEED®) to measure energy efficiency and sustainable building practices.



As a WaterSense Partner we signed an agreement with the U.S. Environmental Protection Agency (EPA) to show our commitment to promote its goals for national water efficiency.



T&S is deeply committed to water and energy conservation and sustainable practices in manufacturing the industry's most energy-efficient foodservice and plumbing products. We are proud to be affiliated with these three organizations.

The "LEED Certification Mark" is a registered trademark owned by the U.S. Green Building Council and is used by permission.

Company History

With a steadfast commitment to quality, T&S Brass and Bronze Works, Inc. for 70 years has set the standard of excellence for the plumbing industry.

Founded in 1947, T&S originally developed foodservice plumbing equipment, including the markets' first pre-rinse unit, which became the industry standard. In 1950, we introduced its full line of foodservice plumbing products, establishing T&S as the premier manufacturer in the industry. By 1953, T&S introduced the foot pedal valve, the next T&S product to become the industry standard.

Over the next four decades, we entered new markets within the plumbing industry. In 1956, T&S made its debut into the laboratory market with its Lab-Flo line of laboratory service fittings. Four years later, the company expanded into nonresidential markets with industrial grade faucets for institutional applications, and penetration of the commercial plumbing market began.

Today, T&S produces faucets, fittings and specialty products for foodservice, industrial, commercial plumbing and laboratory markets. Our products have become the standard for the majority of U.S. hospitals, schools, restaurants, prisons, and public facilities.

T&S expansion, however, has not been limited to the borders of the United States. During the last thirty years, the company has significantly increased overseas exports. Today, representatives sell T&S products around the world – in Europe, Australia, the Middle East, Canada, Japan, southeast Asia and Central and South America.

To support its growing global distribution system, T&S has established facilities on several continents. More than 200 employees manufacture products and service customers from company headquarters in Travelers Rest, South Carolina, with a second U.S. distribution center in Simi Valley, California to more efficiently serve the west coast. An overseas office and distribution center is located in Europe.

Leading the way in innovation, quality manufacturing and customer service, T&S will remain dedicated to the same level of excellence which established its reputation and what our customers rely on – Reliability Built In™.

Warranty Information

All T&S products are warranted to be free from defects in material and workmanship for a period of one (1) year from the date of purchase. Liability is limited thereunder to factory repair and/or replacement of material found to be defective, after examination by T&S, during the warranty period. No claims for labor, shipping costs or consequential damages will be accepted or honored.

Replacement and/or repair under this warranty will be made within a reasonable time after receipt by T&S of the allegedly defective item.

Items which have received secondary finishing or have been altered in any way after purchase are not covered by this warranty. Claims resulting from damaged cartons must be filed with the carrier.

Some states do not allow limitations on how long an implied warranty lasts or on the exclusion of incidental or consequential damages, so all the limitations or exclusions appearing herein may not be permitted by your state and, therefore, your local statutes should be consulted with respect thereto or with respect to any other rights which your state statutes may specifically confer on you.

After receiving proper authorization, all returns of merchandise which are claimed defective under this warranty must be sent to T&S Brass and Bronze Works, Inc., P.O. Box 1088, 2 Saddleback Cove, Travelers Rest, SC 29690, clearly marked to the attention of the Warranty Repair Department. Shipping charges, both ways, shall be paid by the customer.



RELIABILITY BUILT IN™

ACS Accessories



A Pre-Rinse Units



B Pot, Kettle and Glass Fillers



C Faucets and Components



CP ChekPoint™ Electronic Faucets



D Institutional, Medical and Lab Products



E Washdown and Clean-Up Solutions



F Safe-T-Link Gas and Water Appliance Connectors



G Parts Kits



H Emergency Safety Equipment by Haws



I Equip Plumbing Products



J Pet Care Plumbing Products



T&S BRASS
G-12
PRODUCT OVERVIEW



T&S Brass

Your Source for Buy American Act Products



T&S Brass is pleased to produce over 5,000 products and parts that comply with the requirements of the Buy American Act.

Please request a copy of our Buy American brochure for a complete list of Buy American products or visit our website, www.tsbrass.com

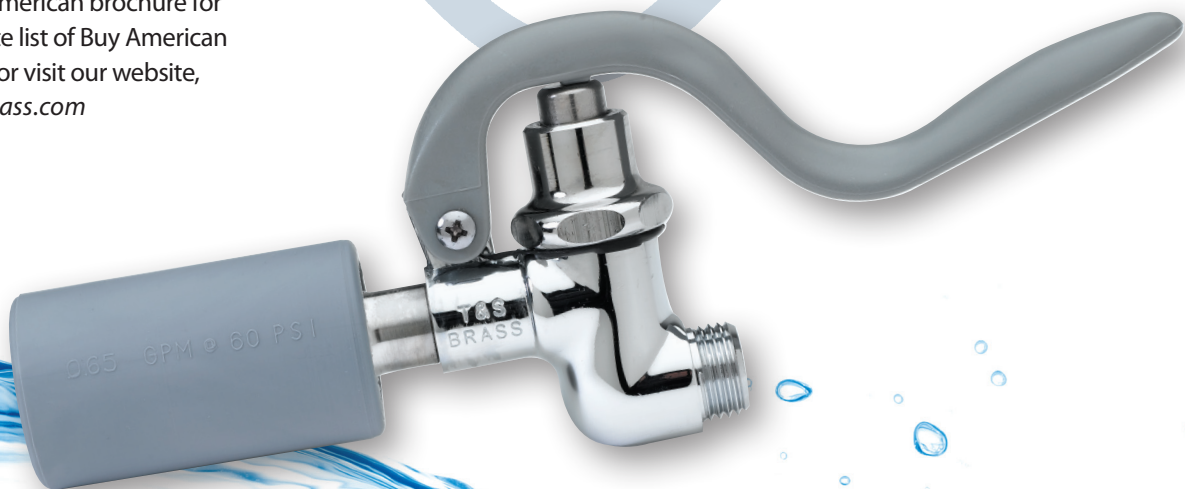

ACS Accessories	Nozzles, Goosenecks and Spouts • Aerators, Laminar Flow Outlets and Non-Aerated Spray Devices • Cartridge Assemblies • Hot and Cold Spindle Assemblies • Adapters • Handles • Inlet Product Options • Hoses
A Pre-Rinse Units	Single Hole Deck-Mount Pre-Rinse • 8" Deck-Mount Pre-Rinse • 8" Wall-Mount Pre-Rinse • Swivel for Pre-Rinse Units • Accessory Tees • Spray Valve, Faucet and Hose Assemblies • Spray Valve / Pre-Rinse Accessories
B Pot, Kettle and Glass Fillers	Glass Fillers and Water Stations • Water Filtration Models • Pot and Kettle Fillers • Range Faucets and Pot Fillers • Kettle Kaddy Spray Stanchions • Big-Flo Faucets • Dipperwell Faucets • Accessories
C Faucets and Components	Swivel/Rigid Single and Double Pantry Faucets • Wall Mount Adjustable Centers Dual Temp Faucets • Workboard Faucets • Water-Saving Faucet Models • Waste Valves • T&S Product Adaptability • Faucet-Nozzle Charts
CP ChekPoint™ Electronic Faucets	ChekPoint™ Sensor Faucets with Above Deck Electronics • Below Deck Electronic Faucets • Thermostatic Mixing Valve Models • Hydrogenerator Models • Features and Options Charts • Ware-Washing Rinse Faucet
D Institutional, Medical and Lab Products	Single Lever Faucets • Lavatory Faucets • Pedal Valves, Dummy Goosenecks and Bubblers • Service Sink and Sill Faucets • Concealed Widespread Faucets • Bedpan Washers • Vacuum Breakers • Laboratory Models
E Washdown and Clean-Up Solutions	Stainless Steel Open and Enclosed Retractable Hose Reels • Painted Steel Open and Enclosed Retractable Hose Reels • Complete Hose Reel Systems Charts • Water Guns and Spray Valves • Washdown Stations / Accessories
F Safe-T-Link Gas and Water Appliance Connectors	Gas Appliance Connectors and Accessories • Water Appliance Connectors and Accessories • SwiveLink and FreeSpin Fittings • Quick-Disconnects • POSI-SET Wheel Placement System For Moveable Cooking Equipment
G Parts Kits	Parts, Repair and Installation Kits / Pre-Rinse and Spray Valve Parts • Cartridges and Spindle Assemblies • Faucet and Handle Parts Kits • Plumbing and Waste Valve Kits • Glass Filler and Vacuum Breaker Repair Kits
H Emergency Safety Equipment by Haws	Emergency Safety Equipment For On-the-Job Eye Safety / Eye and Face Wash Units • Eyewash Stations • Counter-Mounted Eye/Face Wash Unit • Tempered Water Blending Valve • Safety Recording, Parts and Repair Kits
I Equip Plumbing Products	Equip Electronic Faucets / Equip Deck- and Wall-Mount Pre-Rinse Units • Equip Faucets • Equip Glass Fillers • Equip Hose Reels, Water Guns and Spray Valves • Swing Nozzles and Goosenecks • Accessories
J Pet Care Plumbing Products	Wash and Rinse Pre-Rinse and Faucets / Pet Grooming Stations • Wall and Deck Mount Faucets with Sprays • Equip Electronic and Hands-Free Faucets • Hose Reels • Sprays / Water Guns • Washdown Station • Eyewash Safety
IN Master Index	



Product Adaptability

T&S Brass offers unparalleled product adaptability. Our extensive product lines include base faucets, nozzles, aerators, goosenecks, spouts, handles and inlet options, and many combinations of T&S components are available.

Nozzles, Goosenecks and Spouts

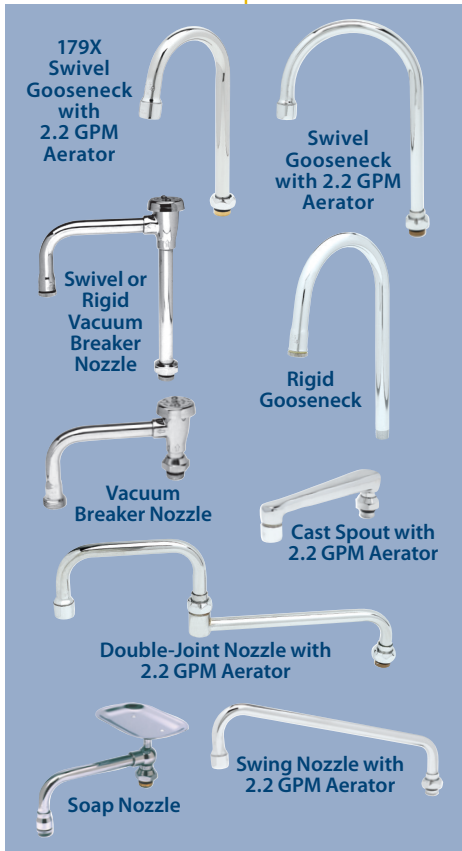

Handles



Inlets



Outlets



T&S Swivel or Rigid Faucets can combine with a wide variety of T&S Goosenecks, Nozzles, Spouts, Handles, Inlets and Aerators

For example to customize your faucet, you could specify:

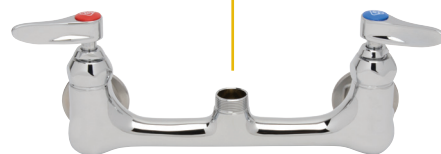

B-0230-LN Faucet with Lever Handles and Quarter-Turn Eterna Cartridges + Swivel Gooseneck with 2.2 GPM Vandal-Resistant Aerator = 8" Wall Mount Mixing Faucet

If Your World Is Ceramic, Choose **T&S Cerama**

The Commercial Grade Ceramic Cartridge Built to Last a Lifetime

T&S offers the first truly commercial ceramic cartridge designed for heavy use in both foodservice and plumbing applications and backed by a lifetime guarantee. Cerama represents the latest in ceramic disc technology and is made from the finest materials. Precision-polished to form a perfect fit, the discs create a watertight seal that will not leak.

Only the T&S Cerama offers the benefits of true commercial construction. Cerama has a solid brass spindle and body, which provides rugged durability. Cerama's sturdy spline gives a solid permanent lock and provides superior torque resistance. Cerama can withstand temperatures up to 180°F, and integrated cartridge baffles at the outlets reduce water hammer and provide quiet operation.



**U.S. Patent
5,996,614**

As an added benefit for applications with valves downstream, T&S Cerama is the only ceramic cartridge (U.S. Patent # 5,996,614) that comes with an optional integral check valve, which is critical for stopping cross flow in applications.

T&S Cerama – manufactured to the highest standards to bring you quality and maintenance-free performance backed by a lifetime guarantee.

T&S Cartridge Water Savings - GPM Chart

	At 60 PSI	At 60 PSI (with spring checks)
T&S Eterna	8 GPM per side	6 GPM per side
T&S Cerama	6 GPM per side	5 GPM per side

If Your World Is Compression, Choose **T&S Eterna**

The Compression Cartridge That Specifiers and End-Users Have Relied on For Over 50 Years

T&S Eterna cartridges “rule” the compression world. Tried and true, the Eterna cartridge has impressed specifiers and end-users alike with its rugged quality, flexibility, common sense design and superior value. Eterna is a proven compression cartridge backed by experience and the excellent T&S standard warranty. Its solid brass body is the mark of a true commercial grade product.



Certification

As a leader in quality manufacturing, T&S Brass proudly displays certificates that demonstrate that we have met the stringent standards developed by the International Standardization Organization (ISO), ASME International, NSF International and CSA International (Canadian Standards Association).

Our company's ISO-9001:2015 certification is based on an evaluation of its performance of the various jobs and processes that potentially affect product quality. T&S guarantees its products will be manufactured to the highest standards in the industry with the finest craftsmanship possible.



Underwriters Laboratories plays a key role in evaluating how T&S meets the ISO-9001:2015 standard. As the Quality Systems Registrar, UL DQS Inc. was responsible for the entire registration process and oversees periodic assessments to help T&S maintain its goal of exceeding customer expectations for quality manufacturing and service.

CSA International handles the vast majority of third-party testing and certifications for T&S Brass products. These product certifications are a further demonstration of our company's commitment to the needs of our customers and their communities. Following an evaluation for both the leaching of contaminants into drinking water from faucets and the mechanical quality standards, T&S pre-rinse units, drinking water products and lavatory faucets meet or exceed the NSF/ANSI Standard 61, Section 9 standard for Drinking Water Systems (Health Effects) and the ASME A112.18.1 / CSA B125.1 standard for mechanical quality. In short, T&S products are both safe for use within any drinking water system and adhere to the mechanical quality standards for ease of installation, operation, and reliability.

By meeting or exceeding the standards set by these internationally recognized organizations, we demonstrate our commitment to deliver the highest quality products to customers around the world.



At T&S Brass, we are pleased to take a leading role in innovating and developing AB1953-compliant fixture fittings. Look to T&S's website, www.tsbrass.com for news and products related to AB1953 and the newly released NSF/ANSI 372 Drinking Water Systems Components – Lead Content. Contact your sales representative or T&S customer service for more information. And enjoy the confidence that comes with Reliability Built In™.



Attention: California Residents

California's Proposition 65 requires that California consumers receive warnings about any products which contain chemicals known to the State of California to cause cancer or birth defects or other reproductive harm. The State of California requires the following notice: **WARNING:** This product contains chemicals known to the State of California to cause cancer, and birth defects or other reproductive harm.

Associations





RELIABILITY BUILT IN™

G-12

ACS Accessories



Accessories – ACS

NEW T&S PRODUCTS:
 • Redesigned Faucet Cartridges, Nozzles, Spouts, Aerators and Handles ACS 3-19

Faucets and FittingsACS3-13

- NEW!** Nozzles, Goosenecks, Spouts 3-8
- Big-Flo Nozzles 8
- Custom Goosenecks and Nozzles 9
- NEW!** Aerators Chart 10
- Laminar Flow Outlets Chart 11
- Non-Aerated Spray Devices Chart 11
- Other Outlets (Series 1 and 2) 12

NEW! Cartridge Assemblies ACS14-19

- Eterna Charts (Old and New Style) 14-15
- Eterna Assembly Models/Parts 16
- Big-Flo Assembly Models/Parts 16
- Push Button and Wrist-Action Metering Cartridge Models/Parts 16
- B-1100 Series Previous Design Spindle Assembly Charts 17
- Cerama Charts (Old and New Style) 18-19

NEW! Handles and Other Faucet Accessories ACS20-21

- Handles 20-21
- Vandal-Resistant Keys 21
- Soap Dishes and Deck Plates 21

Inlet Product Options ACS22-24

- Union Coupling Inlets 22
- Inlet Extensions 23
- Supply Nipple Kits 23
- Elbows and Tees 24

Adapters, Risers, Connectors ACS24-26

- Adapters, Inlets and Supply Connectors 24
- Risers and Connectors 25
- Conversion and Inlet Adapters 25-26

NOTE:
 A comprehensive Index By Model or Part Number and Page can be found in the G-12 General Product Catalog Master Index section (IN).

Replacement Hoses ACS28-29

- Flexible Stainless Steel, PVC, Vinyl
- Hose Chart: Stainless, PVC and Vinyl Hoses

T&S Brass and Water Conservation ACS30

- Definitions and Use: T&S Water Conservation Products
- Aerators, Laminar Flow Outlets and Non-Aerated Spray Device Outlets
- Plain End Outlets with Flow Control

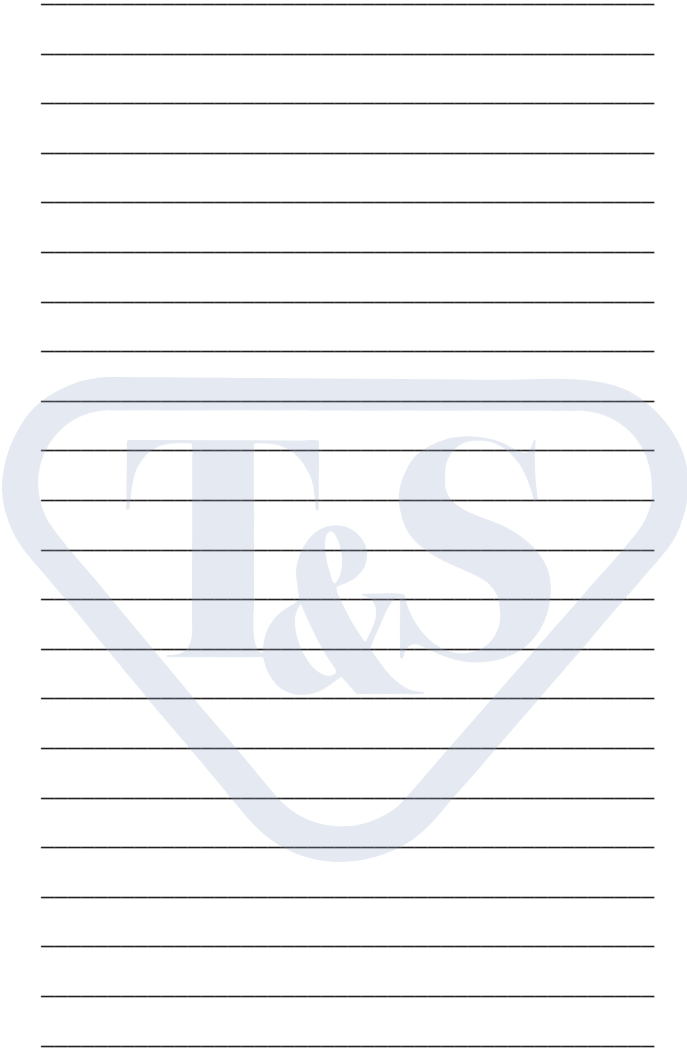

? Can't find the T&S product you're looking for?
 Please visit www.tsbrass.com for a complete product listing.

Nozzles, Goosenecks and Spouts

Swing Nozzles

SERIES
1
OUTLETS

- Nozzle tip has 55/64-27 UN male threads for Series 1 outlets and stream regulator (B-PT)

NEW DESIGN! Updated full flow stream regulator



- 059XM Master Box (12)
- 060XM Master Box (12)
- 061XM Master Box (12)
- 062XM Master Box (12)
- 063XM Master Box (12)
- 064XM Master Box (12)
- 065XM Master Box (12)

Note: See p. ACS 10-11 for other Series 1 outlets used with these swing nozzles

Model No.	Standard Sizes Length	Height	Clearance	Outlet/Series	GPM
059X	6" (153 mm)	5-1/8" (130 mm)	2" (51 mm)	B-PT Stream Regulator Outlet	—
059X-A12	6" (153 mm)	5-1/8" (130 mm)	2" (51 mm)	B-0199-01-F12 Aerator	1.2 GPM
059X-A22	6" (153 mm)	5-1/8" (130 mm)	2" (51 mm)	B-0199-01 Aerator	2.2 GPM
059X-V12	6" (153 mm)	5-1/8" (130 mm)	2" (51 mm)	B-0199-06-F12 VR Aerator	1.2 GPM
059X-V22	6" (153 mm)	5-1/8" (130 mm)	2" (51 mm)	B-0199-06 VR Aerator (Ser. 1)	2.2 GPM
060X	8" (203 mm)	5-11/16" (144 mm)	2-9/16" (66 mm)	B-PT Stream Regulator Outlet	—
060X-A22	8" (203 mm)	5-11/16" (144 mm)	2-9/16" (66 mm)	B-0199-01 Aerator	2.2 GPM
061X	10" (254 mm)	6-3/8" (163 mm)	3-1/4" (83 mm)	B-PT Stream Regulator Outlet	—
061X-A22	10" (254 mm)	6-3/8" (163 mm)	3-1/4" (83 mm)	B-0199-01 Aerator	2.2 GPM
061X-V22	10" (254 mm)	6-3/8" (163 mm)	3-1/4" (83 mm)	B-0199-06 VR Aerator (Ser. 1)	2.2 GPM
062X	12" (305 mm)	7-1/16" (179 mm)	3-15/16" (100 mm)	B-PT Stream Regulator Outlet	—
062X-A12	12" (305 mm)	7-1/16" (179 mm)	3-15/16" (100 mm)	B-0199-01-F12 Aerator	1.2 GPM
062X-A15	12" (305 mm)	7-1/16" (179 mm)	3-15/16" (100 mm)	B-0199-01-WS Aerator	1.5 GPM
062X-A22	12" (305 mm)	7-1/16" (179 mm)	3-15/16" (100 mm)	B-0199-01 Aerator	2.2 GPM
063X	14" (356 mm)	7-3/4" (197 mm)	4-5/8" (117 mm)	B-PT Stream Regulator Outlet	—
063X-A22	14" (356 mm)	7-3/4" (197 mm)	4-5/8" (117 mm)	B-0199-01 Aerator	2.2 GPM
063X-V15	14" (356 mm)	7-3/4" (197 mm)	4-5/8" (117 mm)	B-0199-06-WS Aerator	1.5 GPM
063X-V22	14" (356 mm)	7-3/4" (197 mm)	4-5/8" (117 mm)	B-0199-06 VR Aerator (Ser. 1)	2.2 GPM
064X	16" (407 mm)	8-9/16" (217 mm)	5-7/16" (138 mm)	B-PT Stream Regulator Outlet	—
064X-A22	16" (407 mm)	8-9/16" (217 mm)	5-15/16" (152 mm)	B-0199-01 Aerator	2.2 GPM
065X	18" (457 mm)	9-1/16" (230 mm)	5-15/16" (152 mm)	B-PT Stream Regulator Outlet	—
065X-A22	18" (457 mm)	9-1/16" (230 mm)	5-15/16" (152 mm)	B-0199-01 Aerator	2.2 GPM

ACS3

Accessories

SUFFIX KEY

-A12	Aerator, 1.2 GPM
-A15	Aerator, 1.5 GPM
-A22	Aerator, 2.2 GPM
-LAM	Laminar Flow Outlet
-VR	Vandal-Resistant
-V05	Non-Aerated Spray Device, Vandal-Resistant, 0.5 GPM
-V12	Aerator, Vandal-Resistant, 1.2 GPM
-V15	Aerator, Vandal-Resistant, 1.5 GPM
-V22	Aerator, Vandal-Resistant, 2.2 GPM

Nozzles, Goosenecks and Spouts

ACS4

Accessories

Double-Joint Nozzles

SERIES
1
OUTLETS

- Nozzle tip has 55/64-27 UN male threads Series 1 outlets and stream regulator (B-PT)

NEW DESIGN! Updated full flow stream regulator



Double-Joint Nozzle Sections:

151X	6" (152 mm) back section
152X	9" (229 mm) back section
153X	6" (152 mm) front section

Note: See p. ACS 10-11 for other Series 1 outlets used with these double-joint swing nozzles

Model No.	Standard Sizes Back Section	Front Section	Total Length	Height	Clearance	Outlet	GPM
066X	6" (151X) (153 mm)	6" (153X) (152 mm)	12" (305 mm)	7-3/16" (182 mm)	3-15/16" (101 mm)	B-PT Stream Reg. Outlet	–
066X-A22	6" (151X) (153 mm)	6" (153X-A22) (152 mm)	12" (305 mm)	7-3/16" (182 mm)	3-15/16" (101 mm)	B-0199-01 Aerator	2.2 GPM
067X	9" (152X) (229 mm)	6" (153X) (152 mm)	15" (381 mm)	7-3/16" (182 mm)	3-15/16" (101 mm)	B-PT Stream Reg. Outlet	–
067X-A22	9" (152X) (229 mm)	6" (153X-A22) (152 mm)	15" (381 mm)	7-3/16" (182 mm)	3-15/16" (101 mm)	B-0199-01 Aerator	2.2 GPM
068X	12" (002871-40) (305 mm)	6" (153X) (152 mm)	18" (457 mm)	7-3/16" (182 mm)	3-15/16" (101 mm)	B-PT Stream Reg. Outlet	–
068X-A22	12" (002871-40) (305 mm)	6" (153X-A22) (152 mm)	18" (457 mm)	7-3/16" (182 mm)	3-15/16" (101 mm)	B-0199-01 Aerator	2.2 GPM
069X	12" (002871-40) (305 mm)	12" (006186-40) (305 mm)	24" (610 mm)	6-11/16" (169 mm)	3-1/2" (90 mm)	B-PT Stream Reg. Outlet	–
069X-A22	12" (002871-40) (305 mm)	12" (019602-40) (152 mm)	24" (610 mm)	6-11/16" (169 mm)	3-1/2" (90 mm)	B-0199-01 Aerator	2.2 GPM

Swivel Gooseneck

SERIES
1
OUTLETS

SERIES
2
OUTLETS

- Swivel gooseneck with various outlets
- Fits all standard T&S swivel outlets



Swivel Gooseneck/Stream Regulator:

131XM	Master Box (6)
132XM	Master Box (6)
133XM	Master Box (6)
135XM	Master Box (6)

Note: See p. ACS 10-11 for other Series 1 or Series 2 outlets used with these goosenecks

Model No.	Standard Sizes Spread	Height	Clearance	Outlet/Series	GPM
131X	2-15/16" (74 mm)	4-3/4" (121 mm)	2-3/16" (56 mm)	B-PT Stream Regulator (Series 1)	–
131X-A22	2-15/16" (74 mm)	4-3/4" (121 mm)	2-3/16" (56 mm)	B-0199-01 Aerator (Ser. 1)	2.2 GPM
132X	2-7/8" (73 mm)	8-9/16" (217 mm)	5-9/16" (141 mm)	B-LT Stream Regulator (Series 2)	–
132X-A22	2-7/8" (73 mm)	8-9/16" (217 mm)	5-9/16" (141 mm)	B-0199-01 Aerator (Ser. 1)	2.2 GPM
132X-V05	2-7/8" (73 mm)	8-9/16" (217 mm)	5-9/16" (141 mm)	B-0199-06-N05 VR Non-Aer.Spray Device (Ser. 1)	0.5 GPM
133X	5-3/4" (146 mm)	10-5/16" (262 mm)	5-7/8" (150 mm)	B-PT Stream Regulator (Ser. 1)	–
133X-A12	5-3/4" (146 mm)	10-5/16" (262 mm)	5-7/8" (150 mm)	B-0199-01-F12 Aerator (Ser.1)	1.2 GPM
133X-A15	5-3/4" (146 mm)	10-5/16" (262 mm)	5-7/8" (150 mm)	B-0199-01-WS Aerator (Ser. 1)	1.5 GPM
133X-A22	5-3/4" (146 mm)	10-5/16" (262 mm)	5-7/8" (150 mm)	B-0199-01 Aerator (Ser. 1)	2.2 GPM
133X-LAM	5-3/4" (146 mm)	10-5/16" (262 mm)	5-7/8" (150 mm)	B-0199-21 Laminar Flow Device (Ser. 1)	2.2 GPM
133X-LAM-VR	5-3/4" (146 mm)	10-5/16" (262 mm)	5-7/8" (150 mm)	B-0199-21-VRF VR Lam. Flow Device (Ser. 1)	2.2 GPM
133X-V12	5-3/4" (146 mm)	10-5/16" (262 mm)	5-7/8" (150 mm)	B-0199-06-F12 VR Aerator (Ser. 1)	1.2 GPM
133X-V22	5-3/4" (146 mm)	10-5/16" (262 mm)	5-7/8" (150 mm)	B-0199-06 VR Aerator (Ser.1)	2.2 GPM
134X	7-3/4" (197 mm)	11-7/16" (291 mm)	5-9/16" (141 mm)	B-LT Stream Regulator (Ser. 2)	–
135X	8-3/4" (222 mm)	12-1/16" (306 mm)	5-5/8" (143 mm)	B-LT Stream Regulator (Ser. 2)	–
135X-A22	8-13/16" (224 mm)	12-1/16" (307 mm)	5-1/8" (130 mm)	B-0199-02 Aerator (Ser. 2)	2.2 GPM
135X-LAM	8-3/4" (222 mm)	12-1/16" (306 mm)	5-13/16" (148 mm)	B-0199-21 Laminar Flow Device (Ser. 1)	2.2 GPM
135X-LAM-VR	8-3/4" (222 mm)	12-1/16" (306 mm)	5-13/16" (148 mm)	B-0199-21-VRF VR Lam. Flow Device (Ser. 1)	2.2 GPM
135X-V22	8-3/4" (222 mm)	12-1/16" (306 mm)	5-5/16" (135 mm)	B-0199-06 VR Aerator (Ser.1)	2.2 GPM

Nozzles, Goosenecks and Spouts

179X Series Swivel Gooseneck

SERIES 1
OUTLETS



- Swivel gooseneck with various outlets
- Fits all standard T&S swivel outlets (Series 1)

Model No.	Standard Sizes Spread	Height	Clearance	Outlet/Series	GPM
179X	4-3/8" (111 mm)	9-1/4" (235 mm)	5-5/8" (143 mm)	B-PT Stream Regulator	–
179X-A22	4-3/8" (111 mm)	9-1/4" (235 mm)	5-5/8" (143 mm)	B-0199-01 Aerator	2.2 GPM
179X-L15	4-3/8" (111 mm)	9-1/4" (235 mm)	5-5/8" (143 mm)	B-0199-29VR VR Laminar Flow Device	1.5 GPM (VR)
179X-V12	4-3/8" (111 mm)	9-1/4" (235 mm)	5-5/8" (143 mm)	B-0199-06-F12 VR Aerator	1.2 GPM (VR)
179X-V22	4-3/8" (111 mm)	9-1/4" (235 mm)	5-5/8" (143 mm)	B-0199-06 VR Aerator	2.2 GPM (VR)
187X	3-5/8" (92 mm)	8-3/4" (222 mm)	5-1/2" (140 mm)	B-PT Stream Regulator	–
187A15	3-5/8" (92 mm)	8-3/4" (222 mm)	5-1/2" (140 mm)	B-0199-01-WS Aerator	1.5 GPM

Rigid Gooseneck

SERIES 2
OUTLETS



- Rigid gooseneck with various outlets

Rigid Gooseneck/Stream Regulator:
120XM Master Box (6)

Note: See p. ACS 10-11 for other Series 2 outlets for these goosenecks

Model No.	Standard Sizes Spread	Height	Clearance	Outlet	GPM
119X	2-5/8" (67 mm)	8-3/4" (222 mm)	5-1/4" (133 mm)	B-LT Stream Regulator Outlet	–
120X	5-1/2" (140 mm)	10-1/4" (260 mm)	5-1/4" (133 mm)	B-LT Stream Regulator Outlet	–
120X-LAM	5-9/16" (141 mm)	10-1/4" (260 mm)	4-13/16" (122 mm)	B-0199-21 Laminar Flow Device	2.2 GPM
120X-LAM-VR	5-9/16" (141 mm)	10-1/4" (260 mm)	4-3/4" (121 mm)	B-0199-21-VRF VR Laminar Flow Device	2.2 GPM
122X	5-1/2" (140 mm)	11-1/2" (292 mm)	6-1/2" (165 mm)	B-LT Stream Regulator Outlet	–
123X	5-1/2" (140 mm)	12-1/2" (318 mm)	7-1/2" (191 mm)	B-LT Stream Regulator Outlet	–
125X	5-1/2" (140 mm)	14-1/2" (368 mm)	9-1/2" (241 mm)	B-LT Stream Regulator Outlet	–
126X	5-1/2" (140 mm)	15-1/2" (394 mm)	10-1/2" (267 mm)	B-LT Stream Regulator Outlet	–
127X	7-5/8" (194 mm)	11-1/12" (292 mm)	5-1/2" (140 mm)	B-LT Stream Regulator Outlet	–
127X-V12	7-11/16" (195 mm)	11-1/12" (292 mm)	5" (127 mm)	B-0199-07-F12 VR Aerator	1.2 GPM
129X	8-1/2" (216 mm)	11-3/4" (298 mm)	5-7/16" (138 mm)	B-LT Stream Regulator Outlet	–
130X	12-3/16" (310 mm)	13-3/8" (340 mm)	4-1/2" (114 mm)	B-LT Stream Regulator Outlet	–
165X	4-1/16" (103 mm)	9-1/4" (235 mm)	5-13/16" (148 mm)	B-LT Stream Regulator Outlet	–

SUFFIX KEY

-A12	Aerator, 1.2 GPM	-LAM	Laminar Flow Outlet
-A15	Aerator, 1.5 GPM	-LAM-VR	Laminar Flow Outlet, Vandal-Resistant
-A22	Aerator, 2.2 GPM	-L15	Laminar Flow Device, Vandal-Resistant, 1.5 GPM
-F05	0.5 GPM flow disc in swivel piece	-VR	Vandal-Resistant
-F10	1.0 GPM flow disc in swivel piece	-V05	Non-Aerated Spray Device, Vandal-Resistant, 0.5 GPM
-F12	1.2 GPM flow disc in swivel piece	-V12	Aerator, Vandal-Resistant, 1.2 GPM
-F15	1.5 GPM flow disc in swivel piece	-V22	Aerator, Vandal-Resistant, 2.2 GPM
-F22	2.2 GPM flow disc in swivel piece		

XP Nozzles and Goosenecks with Plain End Outlet

ACS6

Accessories

XP Models
Swing Nozzles

Model No.	Standard Sizes Spread	Height	Clearance	Outlet	GPM
062XP	12" (305 mm)	7-3/8" (188 mm)	4-3/4" (121 mm)	Plain End	–

XP Models
Swivel Gooseneck

Model No.	Standard Sizes Spread	Height	Clearance	Outlet	GPM
132XP Model					
132XP	2-9/16" (66 mm)	8-3/4" (222 mm)	6" (153 mm)	Plain end	–

133XP Models

133XP	5-11/16" (144 mm)	10-5/16" (262 mm)	6-5/16" (163 mm)	Plain end	–
133XP-F05	5-11/16" (144 mm)	10-5/16" (262 mm)	6-5/16" (163 mm)	0.5 GPM flow disc in swivel piece	
133XP-F10	5-11/16" (144 mm)	10-5/16" (262 mm)	6-5/16" (163 mm)	1.0 GPM flow disc in swivel piece	
133XP-F12	5-11/16" (144 mm)	10-5/16" (262 mm)	6-5/16" (163 mm)	1.2 GPM flow disc in swivel piece	
133XP-F15	5-11/16" (144 mm)	10-5/16" (262 mm)	6-5/16" (163 mm)	1.5 GPM flow disc in swivel piece	
133XP-F22	5-11/16" (144 mm)	10-5/16" (262 mm)	6-5/16" (163 mm)	2.2 GPM flow disc in swivel piece	

134XP Model

134XP	7-11/16" (196 mm)	11-3/16" (284 mm)	6-1/16" (154 mm)	Plain end	–
-------	-------------------	-------------------	------------------	-----------	---

135XP Models

135XP	8-11/16" (221 mm)	11-13/16" (300 mm)	6-1/8" (155 mm)	Plain end	–
135XP-F05	8-11/16" (221 mm)	11-13/16" (300 mm)	6-1/8" (155 mm)	0.5 GPM flow disc in swivel piece	
135XP-F22	8-11/16" (221 mm)	11-13/16" (300 mm)	6-1/8" (155 mm)	2.2 GPM flow disc in swivel piece	
179XP	4-1/4" (108 mm)	9-5/16" (237 mm)	6-1/4" (159 mm)	Plain end	
179XP-F05	4-1/4" (108 mm)	9-5/16" (237 mm)	6-1/4" (159 mm)	0.5 GPM flow disc in swivel piece	



133XP



133XP-F12



135XP-F22



179XP-F05

XP Models
Rigid Gooseneck

Model No.	Standard Sizes Spread	Height	Clearance	Outlet	GPM
119XP	2-5/8" (67 mm)	8" (203 mm)	4-3/4" (121 mm)	Plain end	–
120XP	5-1/2" (140 mm)	9-1/2" (241 mm)	4-11/16" (120 mm)	Plain end	–



119XP



120XP

SUFFIX KEY

-F05	0.5 GPM flow disc in swivel piece	-F15	1.5 GPM flow disc in swivel piece
-F10	1.0 GPM flow disc in swivel piece	-F22	2.2 GPM flow disc in swivel piece
-F12	1.2 GPM flow disc in swivel piece		

Nozzles, Goosenecks and Spouts

Soap Dish Nozzle

SERIES 2
OUTLETS

- Swing nozzle assembly with soap dish attachment
- Nozzle tip has 3/8" NPSM female thread for Series 2 outlets and stream regulator (B-LT)
- Fits all standard T&S swivel outlets



Model No.	Length
160X	6" (152 mm)
161X	8" (203 mm)
162X	12" (305 mm)

Note: See p. ACS10-11 for other Series 2 outlets used with these nozzles

OCS6 Swivel Cast Spout

SERIES 2
OUTLETS

- Polished chrome plated cast nozzle with 3/8" NPSM female threads
- OCS models all have Series 2 outlets



Model No.	Length	Height	Clearance	Outlet	GPM
OCS6	6" (152 mm)	2-3/8" (60 mm)	11/16" (24 mm)	B-0199-02	2.2 GPM
OCS6-V05	6" (152 mm)	2-5/16" (59 mm)	11/16" (24 mm)	B-0199-07-N05	0.5 GPM (VR)
OCS6-V22	6" (152 mm)	2-5/16" (59 mm)	11/16" (24 mm)	B-0199-07	2.2 GPM (VR)
OCS8	8" (203 mm)	5-1/8" (130 mm)	3-1/2" (88 mm)	B-0199-02	2.2 GPM
OCS8-LT	8" (203 mm)	5-1/8" (130 mm)	4" (101 mm)	B-LT	-

Note: See p. ACS 10-11 for other Series 2 outlets used with these spouts

ACS7

Accessories

Swivel Vacuum Breaker Nozzle

SERIES 2
OUTLETS

- Nozzle tip has 3/8" NPSM female thread for Series 2 outlets and stream regulator (B-LT)
- **B-0406-02, -03, -04**
Rigid polished chrome plated nozzle with 3/8" NPT male inlet, swivel vacuum breaker – swivels at vacuum breaker
- **B-0407-02, -03, -04**
Swivel polished chrome plated nozzle with vacuum breaker – swivels at base. Fits all standard T&S swivel outlets (B-0407 models only)



Model No.	Spread	Height	Clearance
B-0406-02	5-9/16" (142 mm)	8-15/16" (227 mm)	4-5/8" (118 mm)
B-0406-03	8-9/16" (218 mm)	8-15/16" (227 mm)	4-5/8" (118 mm)
B-0406-04	11-9/16" (294 mm)	8-15/16" (227 mm)	4-5/8" (118 mm)
B-0407-02	5-5/8" (142 mm)	9-1/8" (232 mm)	4-13/16" (123 mm)
B-0407-03	8-9/16" (218 mm)	9-1/8" (232 mm)	4-13/16" (123 mm)
B-0407-04	11-9/16" (294 mm)	9-1/8" (232 mm)	4-13/16" (123 mm)

Note: See p. ACS10-11 for other Series 2 outlets used with these goosenecks

Rigid Vacuum Breaker Nozzle

SERIES 2
OUTLETS

- Rigid polished chrome plated nozzle with vacuum breaker
- 3/8" NPT male inlet
- Nozzle tip has 3/8" NPSM female thread for Series 2 outlets and stream regulator (B-LT)
- Fits all standard T&S rigid outlets



Model No.	Spread	Height	Clearance
B-0405-02	5-5/8" (142 mm)	8-7/8" (225 mm)	4-9/16" (116 mm)
B-0405-03	8-5/8" (219 mm)	8-7/8" (225 mm)	4-9/16" (116 mm)
B-0405-04	11-9/16" (294 mm)	8-7/8" (225 mm)	4-9/16" (116 mm)

Note: See p. ACS10-11 for other Series 2 outlets used with these goosenecks

Nozzles, Goosenecks and Spouts

AC8

Accessories

Vacuum Breaker Swing Nozzle with Stream Regulator

SERIES
2
OUTLETS

- Polished chrome plated swing nozzle with vacuum breaker
- Nozzle tip has 3/8" NPSM female thread for Series 2 outlets and stream regulator (B-LT)
- Fits all standard T&S swivel outlets



Model No.	Spread	Height
B-0408-02	5-9/16" (142 mm)	3-11/16" (93 mm)
B-0408-03	8-9/16" (218 mm)	3-11/16" (93 mm)
B-0408-04	11-9/16" (294 mm)	3-11/16" (93 mm)

Note: See p. ACS10-11 for other Series 2 outlets used with these nozzles

Vacuum Breaker Swing Nozzle with Garden Hose Thread

- Nozzle has 3/4" garden hose thread outlet (B-GH)
- Fits all standard T&S swivel outlets



Model No.	Spread	Height
B-0409-02	5-9/16" (142 mm)	3-11/16" (93 mm)
B-0409-03	8-9/16" (218 mm)	3-11/16" (93 mm)
B-0409-04	11-9/16" (294 mm)	3-11/16" (93 mm)

Note: See p. ACS10-11 for other Series 2 outlets used with these nozzles

Big-Flo Nozzles

Big-Flo Double Joint Swing Nozzle

- Plain end outlet
- Fits all standard T&S Big-Flo faucets



Model No.	Standard Sizes		
	Front Section	Back Section	Clearance
116X	12" (305 mm)	12" (305 mm)	6-13/16" (173 mm)
117X	12" (305 mm)	—	11/16" (17 mm)
118X	—	12" (305 mm)	—

Big-Flo Swing Nozzles

- Plain end outlet
- Fits all standard T&S Big-Flo swivel outlets



Model No.	Standard Sizes		
	Length	Clearance	Height
110X	8" (203 mm)	2-5/8" (67 mm)	6-5/16" (160 mm)
112X	10" (254 mm)	3-1/4" (83 mm)	6-15/16" (176 mm)
114X	12" (305 mm)	4" (102 mm)	7-5/8" (194 mm)
115X	18" (457 mm)	6-1/16" (154 mm)	9-11/16" (246 mm)

Aerators



ACS10
Accessories

	Series 1	Series 2	Series 3	Series 4	Series 5
	<ul style="list-style-type: none"> • 55/64-27 UN female aerator threads • Fits all swing nozzles and 131X and 133X goosenecks 	<ul style="list-style-type: none"> • Includes 3/8" NPSM male thread adapter (044A) and washer (001043-45) • Fits goosenecks except 131X and 133X 	<ul style="list-style-type: none"> • 13/16-27 UN male aerator thread • Fits lavatory spouts 	<ul style="list-style-type: none"> • 15/16-27 UN male aerator thread • Fits single lever line 	<ul style="list-style-type: none"> • 13/16-24 UN female thread • Fits other manufacturer's faucets • Includes adapter and washer
Flow Rate					

Stream Regulators

- Stream regulators:
 - Full flow rate
 - Stream regulators straighten the water flow

Full flow	 B-PT • Female aerator thread	 B-LT • 3/8" male thread • Plain outlet	–	–	–
------------------	--	---	---	---	---

Aerators

- Aerators:
 - Non-splash stream

2.2 GPM (8.3 L/min)	B-0199-01	B-0199-02	B-0199-03	B-0199-04	–
1.5 GPM (5.7 L/min)	B-0199-01-WS	B-0199-02-WS	B-0199-03-WS	B-0199-04-WS	B-0199-05-WS
1.2 GPM (4.54 L/min)	B-0199-01-F12	B-0199-02-F12	B-0199-03-F12	B-0199-04-F12	–
1.0 GPM (3.8 L/min)	B-0199-01-F10	B-0199-02-F10	B-0199-03-F10	–	–

Vandal-Resistant Aerators

- VR Aerators:
 - Non-splash stream
 - Vandal-resistant key included to attach and remove outlet (015425-45)

2.2 GPM (8.3 L/min)	B-0199-06	B-0199-07	B-0199-08	B-0199-09	–
1.5 GPM (5.7 L/min)	B-0199-06-WS	B-0199-07-WS	B-0199-08-WS	B-0199-09-WS	B-0199-10-WS
1.2 GPM (4.54 L/min)	B-0199-06-F12	B-0199-07-F12	B-0199-08-F12	B-0199-09-F12	–
1.0 GPM (3.8 L/min)	B-0199-06-F10	B-0199-07-F10	B-0199-08-F10	–	–

Laminar Flow Outlets and Non-Aerated Spray Devices



	Series 1	Series 2	Series 3	Series 4	Series 5
	<ul style="list-style-type: none"> • 55/64-27 UN female aerator threads • Fits all swing nozzles and 131X and 133X goosenecks 	<ul style="list-style-type: none"> • Includes 3/8" NPSM male thread adapter (044A) and washer (001043-45) • Fits goosenecks except 131X and 133X 	<ul style="list-style-type: none"> • 13/16-27 UN male aerator thread • Fits lavatory spouts 	<ul style="list-style-type: none"> • 15/16-27 UN male aerator thread • Fits single lever line 	<ul style="list-style-type: none"> • 13/16-24 UN female thread • Fits other manufacturer's faucets • Includes adapter and washer

	Flow Rate					
Laminar Flow Devices <ul style="list-style-type: none"> • Non-aerated stream • Screenless 	2.2 GPM (8.3 L/min)	B-0199-21	-	B-0199-26	B-0199-25	-
	1.5 GPM (5.7 L/min)	B-0199-29	-	-	-	-
	1.2 GPM (4.54 L/min)	B-0199-01-LF12	-	-	B-0199-04-LF12	-
Vandal-Resistant Laminar Flow Devices <ul style="list-style-type: none"> • Non-aerated stream • Screenless • Vandal-resistant with key (015425-45) • -VR - female thread • -VRF - female thread • -VRM - male thread 	2.2 GPM (8.3 L/min)	B-0199-21-VRF	-	B-0199-28	B-0199-27	-
	1.5 GPM (5.7 L/min)	B-0199-29VR	-	B-0199-08-LF15	B-0199-09-LF15	-
	1.0 GPM (3.8 L/min)	B-0199-06-LF10	-	B-0199-08-LF10	B-0199-09-LF10	-
	1.2 GPM (4.54 L/min)	B-0199-06-LF12	-	-	-	-
Non-Aerated Spray Devices <ul style="list-style-type: none"> • Non-aerated spray pattern • Screenless • For use in medical facilities to prevent bacteria from entering water stream 	0.35 GPM (1.3 L/min)	B-0199-01-N035	B-0199-02-N035	B-0199-03-N035	B-0199-04-N035	B-0199-05-N035
	0.5 GPM (1.9 L/min)	B-0199-01-N05	B-0199-02-N05	B-0199-03-N05	B-0199-04-N05	B-0199-05-N05
Vandal Resistant Non-Aerated Spray Devices <ul style="list-style-type: none"> • Non-aerated spray pattern • Screenless • For use in medical facilities to prevent bacteria from entering water stream • Vandal-resistant key included to attach and remove outlet (015425-45) 	0.35 GPM (1.3 L/min)	B-0199-06-N035	B-0199-07-N035	B-0199-08-N035	B-0199-09-N035	B-0199-10-N035
	0.5 GPM (1.9 L/min)	B-0199-06-N05	B-0199-07-N05	B-0199-08-N05	B-0199-09-N05	B-0199-10-N05

Outlets

ACS12
Accessories

Series 1 Outlets

SERIES 1
OUTLETS

- 55/64-27 UN female aerator threads
- Fits all swing nozzles and 131X, 133X goosenecks

B-0103-01 Rosespray

- 55/64-27 UN female aerator thread
- Solid brass construction



B-GFE Garden Hose Outlet

- 55/64-27 UN female aerator thread
- Fits on end of nozzle or gooseneck to convert aerator male thread to 3/4" male garden hose thread



B-0199-22 Swivel Aerator

- 55/64-27 UN female inlet
- Includes 15/16-27 UN male adapter
- Swivel outlet
- 2.2 GPM
- Dual spray pattern: aerator or rosespray



Series 2 Outlets

SERIES 2
OUTLETS

- 3/8" NPSM male thread
- Fits goosenecks

B-0103 Rosespray

- Solid brass construction
- 3/8" NPSM male thread



B-0103-FDXX Series Rosespray

- Solid brass construction
- 3/8" NPSM male thread
- B-0103-FDXX models with flow disc regulator and 3/8" NPSM male thread – refer to *Flow Disc Chart* below to specify flow desired

Flow Disc Chart

Model No.	Flow (GPM)	Flow Disc Color
B-0103-FD10	1.00	Grey
B-0103-FD12	1.20	Pink
B-0103-FD15	1.50	Green

B-GH Garden Hose Outlet

- 3/8" NPSM male x 3/4" male garden hose thread adapter



B-0198 Serrated Hose End

- 3/8" NPT male inlet thread
- Serrated hose end accepts rubber or plastic tubing up to 1/2" I.D.



B-0198-FDxx Series Serrated Hose End

- 3/8" NPT male inlet thread
- Straight serrated hose tip with flow disc and retainer assembly
- End accepts rubber or plastic tubing up to 1/2" I.D.
- Refer to *Flow Disc Chart* below to specify flow desired

Flow Disc Chart

Model No.	Flow (GPM)	Flow Disc Color
B-0198-FD05	0.5	–
B-0198-FD10	1.0	Grey
B-0198-FD12	1.2	Pink
B-0198-FD15	1.5	Green

For Serrated Hose End

To order:
Select flow desired, then add suffix to model number.

Ex.: B-0198-FD10 for 1.0 GPM

Lined area for notes with horizontal blue lines.

T&S Eterna Cartridge Assemblies

Our longstanding Eterna Cartridges are the standard on many T&S pre-rinse units, faucets and fittings.

Eterna Cartridge (Old Style) without Spring Check

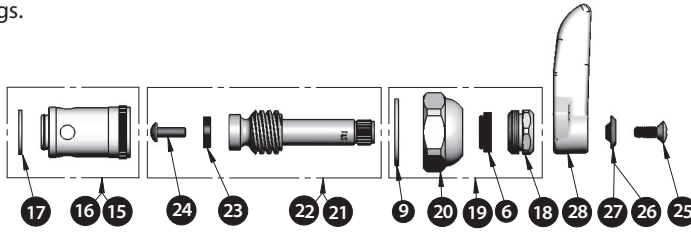

Quarter-Turn Eterna Cartridge (Old Style) without Spring Check

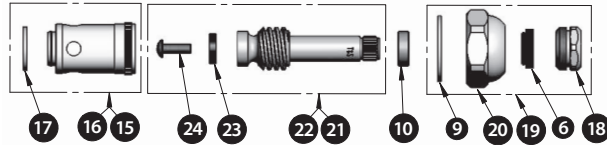

Eterna Cartridge (New Style) with Spring Checks
Used on New Product ID Models

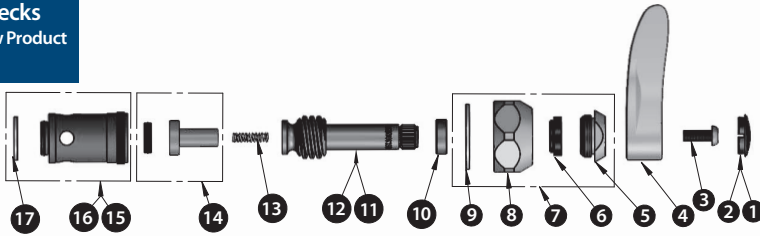

New Style Big-Flo Assembly (-NS)

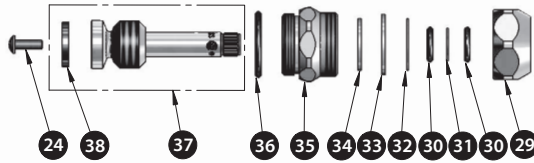

ETERNA – Manual Faucets:

With Lever Handle, Index and Screw

- Cold 002713-40
- Hot 002714-40

No Handle

- Cold 005959-40
- Hot 005960-40

Teflon Seat Washer (for Wrist-Action Handle)

- Cold 006009-40
- Hot 006010-40



Quarter-Turn Cartridge

- Cold 005959-40QT
- Hot 005960-40QT

Quarter-Turn Cartridge with Teflon Seat Washer (for Wrist-Action Handle)

- Cold 006009-40QT
- Hot 006010-40QT



Eterna Quarter-Turn and Spring Check With Lever Handle, Index and Screw (NS)

- Cold 002711-40NS
- Hot 002712-40NS

No Handle

- Cold 012442-40NS
- Hot 012443-40NS



Big-Flo Faucets (-NS):

NEW STYLE Cartridges

- Cold Side for use with Lever Handle (RTC) 006481-40NS
- Cold or Hot Side for use with 4-Arm Handle (LTC) 006482-40NS

Item	Part No.	Description
1	001193-19NS	Red Button Index, Press-In (Hot)
2	018506-19NS	Blue Button Index, Press-In (Cold)
3	000925-45	Handle Screw (New Style)
4	001638-45NS	Lever Handle (New Style)
5	000718-25NS	Packing Nut
6	001098-45	Bonnet Packing Seal
7	000607-40NS	Eterna Bonnet Assembly (New Style)
8	009744-45NS	Eterna Bonnet (New Style)
9	002601-45	Washer
10	001466-20	Quarter-turn Sleeve
11	001907-25	Eterna Cartridge Spindle RTC (Hot)
12	001908-25	Eterna Cartridge Spindle LTC (Cold)
13	001479-45	Spring Check

Item	Part No.	Description
14	003164-45	Spring Check Plunger
15	000788-20	Eterna Removable Insert RTC (Hot) 64L
16	000789-20	Eterna Removable Insert LTC (Cold) 66L
17	001022-45	Bottom Gasket
18	000718-25	Packing Nut (Old Style)
19	000607-40	Eterna Bonnet Assembly (Old Style)
20	009744-45	Eterna Bonnet (Old Style)
21	000811-25	Eterna Spindle (Hot) 18L
22	000812-25	Eterna Spindle (Cold) 67L
23	001092-45	Seat Washer
24	000933-45	Seat Washer Screw
25	000922-45	Lever Handle Screw (Old Style)
26	001661-45	Red Index (Hot) (Old Style)

Item	Part No.	Description
27	001660-45	Blue Index (Cold) (Old Style)
28	001638-45	Lever Handle (Old Style)
29	009750-25NS	Big-Flo Bonnet (New Style)
30	001075-45	'O'-Ring
31	009752-45	Washer, Bonnet, Brass
32	002726-45	Washer, Bonnet, Stainless
33	001042-45	Washer
34	000976-45	Washer
35	000685-40NS	RH Insert, Big-Flo (New Style)
36	002721-45	'O'-Ring
37	000794-25	RH Spindle
38	001088-45	Seat Washer

238A Push Button and Wrist-Action Metering Cartridges

See the *Parts Kits* section, p. G7, for the metering cartridge repair kit (B-238RK)

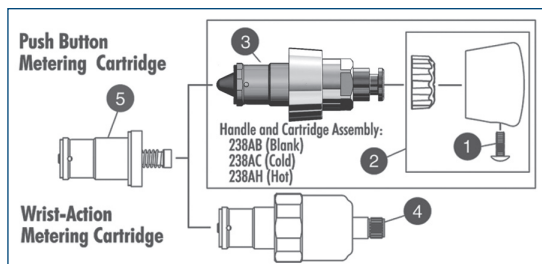

- 1 014145-45 Screw
- 2 014193-40 Push Button Handle, Screw and Insulator (Blank)
- 014194-40 Push Button Handle, Screw and Insulator (Hot)
- 014195-40 Push Button Handle, Screw and Insulator (Cold)
- 3 238A Push Button Metering Cartridge
- 4 012449-40 Wrist-Action Metering Cartridge
- 5 014152-40 Common Metering Barrel Assembly

ACS16
Accessories

Handles

Antimicrobial
Handles Available

B-WH4-NS Wrist-Action Handle

- NEW DESIGN!** Streamlined and modern style for redesigned cartridges (NS)
- New style is the default for all new wrist action handle cartridges and faucets
 - Chrome plated metal wrist-action handle, 4" (102 mm) long
 - Cold index: 018506-19NS
 - Hot index: 001193-19NS
 - Screw only: 000925-45



Model	Description (New Style -NS)
B-WH4-NS	4" (102 mm) Wrist-action handle only
B-WH4H-NS	4" Wrist-action handle, with red (hot) index button and screw
B-WH4C-NS	4" Wrist-action handle, with blue (cold) index button and screw

Old Style B-WH4 Wrist-Action Handle

- Chrome plated metal wrist-action handle, 4" (102 mm) long
- Cold index: 001686-45
- Hot index: 001194-45
- Screw only: 000925-45
- Available with anti-microbial coating (-AM models)



Model	Description (Old Style)
B-WH4	4" (102 mm) Wrist-action handle only
B-WH4H	4" Wrist-action handle, with red (hot) index button and screw
B-WH4C	4" Wrist-action handle, with blue (cold) index button and screw
B-WH6	6" (152 mm) Wrist-action handle only
B-WH6H	6" Wrist-action handle, hot index button and screw
B-WH6C	6" Wrist-action handle, cold index button and screw
B-WH4H-AM	4" Wrist-action handle with red (hot) index and screw with anti-microbial coating
B-WH4C-AM	4" Wrist-action handle with blue (cold) index and screw with anti-microbial coating
B-WH4-AM	4" Wrist-action handle with blank index and screw with anti-microbial coating

Lever Handle

- NEW DESIGN!** Streamlined and modern style for redesigned cartridges (NS)
- New style is the default for all new lever handle cartridges and faucets
 - Chrome plated metal handle
 - Fits most T&S faucets



Model	Description (New Style -NS)
001636-45NS	Lever handle with blue (cold) index and screw
001637-45NS	Lever handle with red (hot) index and screw
001638-45NS	Lever handle only

Old-Style Lever Handle

- Chrome plated metal handle
- Fits most T&S faucets
- Available with antimicrobial coating (see -AM models)



Model	Description (Old Style)
001636-45	Lever handle with blue (cold) index and screw
001637-45	Lever handle with red (hot) index and screw
001638-45	Lever handle with no Index
010027-40	Chrome plated solid brass lever handle
001636-45AM	Lever handle with blue (cold) index and screw, with anti-microbial coating
001637-45AM	Lever handle with red (hot) index and screw, with anti-microbial coating
001638-45AM	Lever handle only with anti-microbial coating

Handles

Antimicrobial Handles Available

002521-45NS Four-Arm Handle

- Chrome plated metal four-arm handle
- Available with antimicrobial coating (-AM models)
- Order index for hot or cold separately
 - Hot handle index (red): 001193-19NS
 - Cold handle index (blue): 018506-19NS
- Handle screw only (000925-45)



Model	Description
175FCNS	Four-arm handle with blue (cold) index and screw
175FHNS	Four-arm handle with red (hot) index and screw
002521-45NS	Four-arm handle only
002521-45KNS	Four-arm handle kit (handle, indexes and screw)
002521-45KNS-VR	Four-arm handle kit (handle, indexes and vandal-resistant screw) and spanner bit

Pivot Action Metering Handle

- Chrome plated metal handle for pivot action metering faucets
- Available with antimicrobial coating (-AM models)



Model	Description
PA-H	Hot pivot action handle with retaining nut and spanner bit
PA-C	Cold pivot action handle with retaining nut and spanner bit
PA-B	Blank pivot action handle with retaining nut and spanner bit

Vandal-Resistant Keys

B-0199-VR-KEY Pro Key

- Pro key for vandal-resistant aerators
- Two-sided for female or male VR aerators



015425-45 Vandal-Resistant Key

- Dual vandal-resistant aerator key for removing VR aerators



Soap Dishes

B-SD Soap Dish

- Chrome plated
- Must be used with soap dish nozzle or B-SDA soap dish assembly



Push Button Handle

- Chrome plated metal handle for push button metering faucets
- Available with anti-microbial coating (-AM model)



Model	Description
014194-40	Hot, with vandal resistant screw and spanner bit
014195-40	Cold, with vandal resistant screw and spanner bit
014193-40	Blank, with vandal resistant screw and spanner bit

Club Handle

- Chrome plated metal decorative handle



Model	Description
009332-41	Club handle with hot index and screw
009331-41	Club handle with cold index and screw
017181-41	Club handle with blank index and screw
000922-45	Handle screw only

Deck Plates

013433-40 and 013434-40 4" and 8" Deck Plates for Single Hole Faucets

Deck Plate features:

- Universal vandal-resistant deck plates
- 4" c/c and 8" c/c available
- Chrome plated brass
- Allow single-hole faucets to be installed in nearly any sink by covering and sealing unused holes
- Mounting hardware included; holds plates securely
- Gaskets provide a tight seal
- Vandal-resistant plates include threaded studs and flange nuts



013433-40
4" Deck Plate



013434-40
8" Deck Plate

Union Coupling Inlets

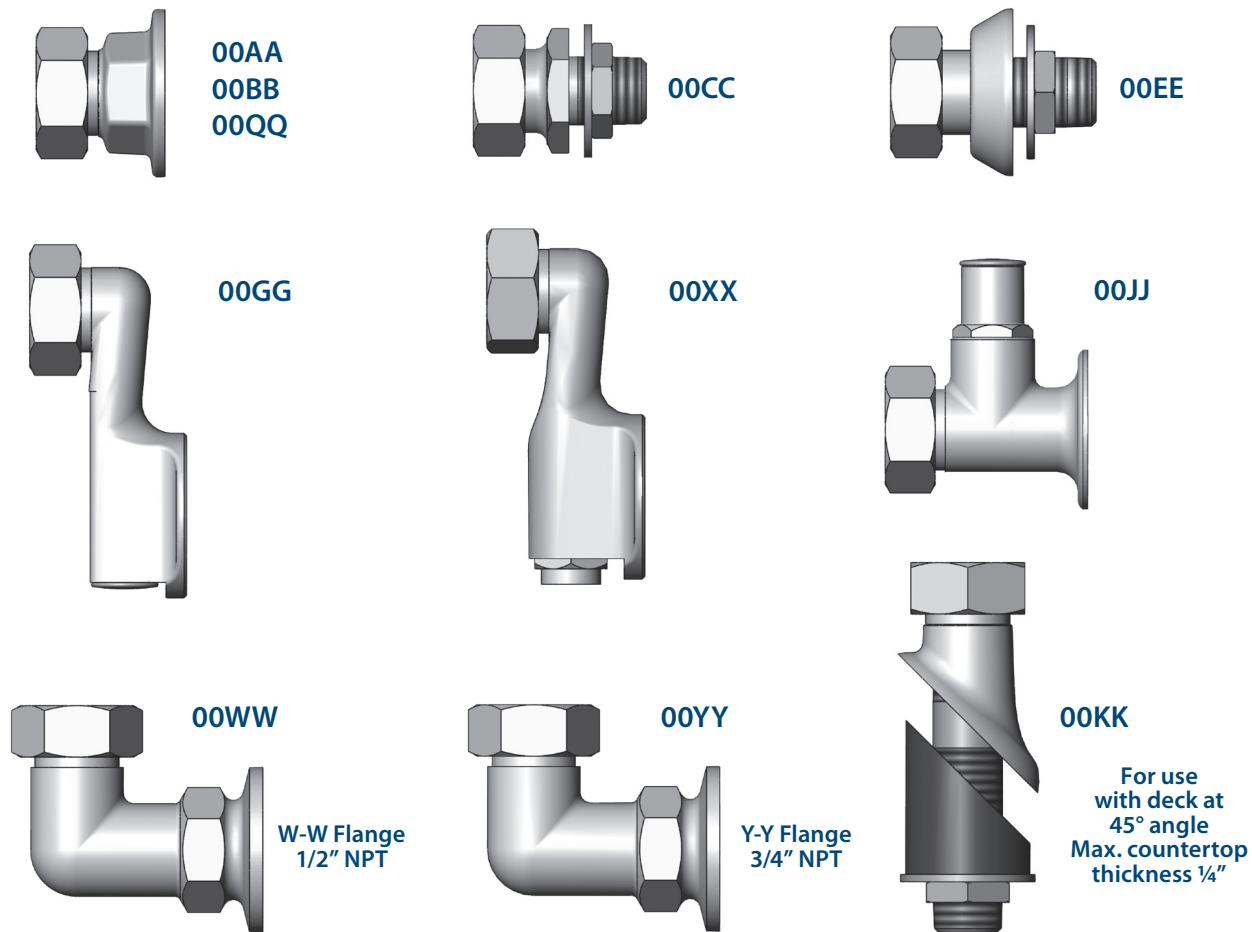

Union Coupling Inlets

The following inlets are polished chrome plated and used on mixing faucets to meet varying conditions of installation. All are interchangeable and are used in lieu of the "00AA" inlets which are ordinarily furnished on faucets using union coupling inlets.

Inlets with an asterisk (*) are available in rough chrome by adding -RGH suffix (ex. 00JJ-RGH).

To order, add suffix letter to faucet model number.

For example: "B-0230-CC" Sink mixing faucet with 1/2" NPT male inlet, 1" (25 mm) long.

- 00AA** 1/2" NPT female eccentric flanged inlet
- 00BB** 3/4" NPT female eccentric flanged inlet
- 00CC** 1/2" NPT male inlet, 1" (25 mm) long
- 00EE** 1/2" NPT male inlet with adjustable flange, 1" (25 mm) long
- 00GG*** 1/2" NPT female flanged adjustable arm inlet
- 00XX*** 1/2" NPT female flanged adjustable arm inlet with screwdriver stop
- 00JJ** 1/2" NPT female inlet with loose key stop
- 00WW** 1/2" NPT female flange 90° inlet
- 00YY** 3/4" NPT female flange 90° inlet
- 00KK** 1/2" NPT male inlet for use on 45° decks. Inlet is at 45° angle to mounting face
- 00QQ** 3/8" NPT female eccentric flanged inlet

Inlet Extensions

- All inlet extensions are:
 • Polished chrome plated

B-0440, B-0441, B-0442, B-0443

B-0440, B-0441, B-0442 and B-0443

- Used on the inlets of either wall- or deck-mounted union coupling style mixing faucets to extend inlets
- 00AA 1-1/4" (32 mm) inlet standard on typical wall-mounted faucets. Ex.: B-0230

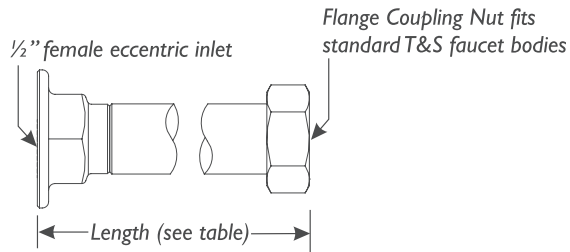

MODEL	INLET	OUTLET	LENGTH	NOTES
B-0440	1/2" NPT Female Eccentric	Flange Coupling Nut	3" (76 mm)	Adds 1-3/4" (44 mm) length to standard 00AA inlet
B-0441	1/2" NPT Female Eccentric	Flange Coupling Nut	4" (102 mm)	Adds 2-3/4" (70 mm) length to standard 00AA inlet
B-0442	1/2" NPT Female Eccentric	Flange Coupling Nut	5-3/4" (146 mm)	Adds 4-1/2" (114 mm) length to standard 00AA inlet
B-0443	1/2" NPT Female Eccentric	Flange Coupling Nut	6-3/4" (171 mm)	Adds 5-1/2" (140 mm) length to standard 00AA inlet
B-0445	1/2" NPT Female	1/2" NPT Female	1" (25 mm)	Used to extend faucets with 1/2" NPT male inlets

B-0445

- This inlet extension is used to extend faucets with 1/2" NPT male inlets.
 Ex.: B-0704 faucet with B-0445 inlet extension

B-0445

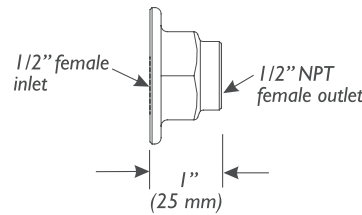

Supply Nipple Kits Includes Lock Nut and Washer

B-0423

1/2" Supply Nipple

- 1/2" NPT x 1-1/4" long

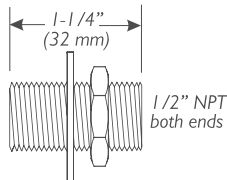

B-0424

1/2" Supply Nipple

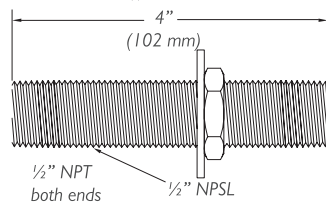

B-0425

1/2" Supply Nipple

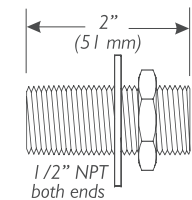

B-0425-M Master Box (2)

B-0426

1/2" Supply Nipple

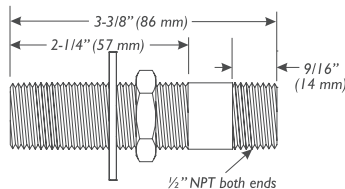

B-0427

3/4" Supply Nipple

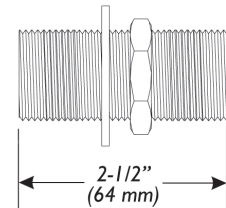

B-0428

3/8" Supply Nipple

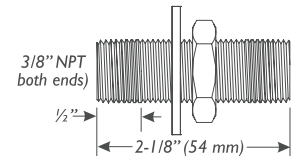

B-0429

3/8" Supply Nipple

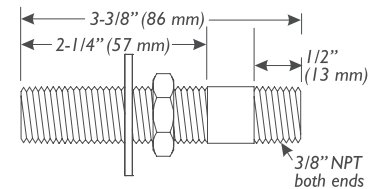

Elbow and Tees

00LL

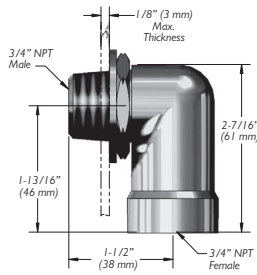

148X

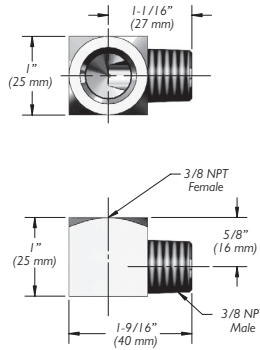

Elbows	
Model No.	Description
148X	3/8" Street Elbow
001355-40	3/8" Cast Elbow
006895-20	1/2" Short Elbow, plain brass
150X	1/2" Street Elbow
001357-40	1/2" Cast Elbow
00LL	3/4" Short Elbow, plain brass
001720-40	3/4" Cast Elbow

150X

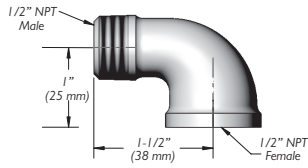

001355-40

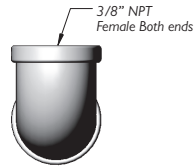

001357-40

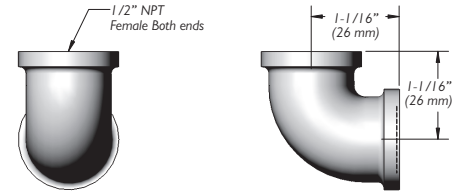

001720-40

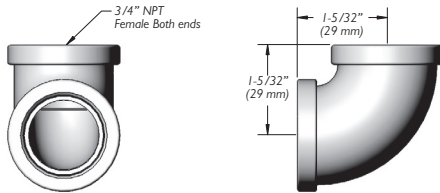

006895-20

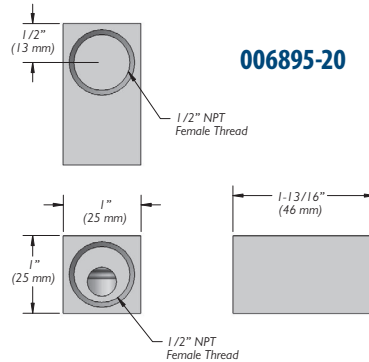

Adapters, Inlet and Supply Connectors

Adapter Chart

Dimensions	Model
3/8 NPSM male x 3/4-11 1/2 G.H. male	B-GH
1/2 NPT male x 3/8 NPT female (Hex bushing)	001359-40
3/4-14 male x 1/4 NPT male (Fisher adapter)	002584-25 (172A)
3/4-14 male x 1/4 NPT female	052A
3/4-14 male x 3/8 NPT male (Chicago adapter)	053A
3/4-14 male x 3/8 NPT female (Hex stock)	054A
3/4 G.H. female x 1/2 NPT male	003105-40
3/4-14 male x 5/8-27 female	000552-25
3/4-14 male x 3/4 NPT male	057A
3/4-14 male x 3/4 NPT female	058A
3/4-14 male x 3/4-14 male	098A
55/64-27 male x 1/8 NPT female	001624-25
55/64-27 male x 5/8-27 female	000554-25
55/64-27 female x 3/4-11 1/2 G.H. male	B-GFE

150A Union Coupling Tailpiece

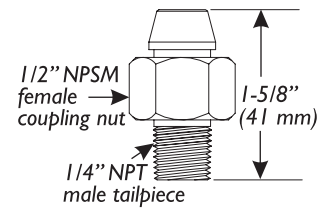

- 1/4" NPT tailpiece with nut fits 1/2" NPT and NPS faucet shanks with 30° tapered inlet

Risers and Connectors

3/8" Riser Lengths

3/8" NPT male both ends



Model No.	Length	Model No.	Length
000357-40	2" (51 mm)	000369-40	18" (457 mm)
000358-40	3" (76 mm)	000372-40	24" (610 mm)
000361-40	5" (127 mm)	000376-40	32" (813 mm)
000363-40	7" (178 mm)	Contact factory for sizes not shown.	

Couplings

- Used to connect two (2) pipes
- Same thread size on both ends
- Chrome plated brass

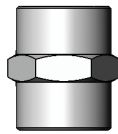

Model No.	Dimension	Length
001769-40	3/8" NPT	1-1/8" (29 mm)
001684-25	1/2" NPT	1-5/16" (33 mm)
004710-25	3/4" NPT	1-7/16" (37 mm)

Close Nipples

- Same male thread size on both ends
- Close nipple will be completely concealed

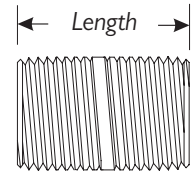

Model No.	Dimension	Length
002535-25	3/8" NPT	1" (25 mm)
002534-25	1/2" NPT	1-1/8" (29 mm)
004741-25	3/4" NPT	1-3/8" (35 mm)

Check Valves

- Rough brass finish
- Designed for water use only
- For horizontal or vertical use



B-CVH1-2	1/2" NPT female connections	2-3/8" length
B-CVH3-4	3/4" NPT female connections	2-7/8" length
B-CVH3-8	3/8" NPT female connections	2-5/16" length

Conversion Adapters

B-0412 Adapter

- Rigid to swivel adapter
- Use for field conversion where a faucet with 3/8" NPT outlet is installed and a swivel gooseneck or nozzle is required



B-0412-M Master Box (2)

B-0413 Adapter

- Swivel to rigid adapter
- Used for field conversion where a faucet with swivel outlet is installed and a 3/8" rigid gooseneck is required



B-0413-M Master Box (2)
B-0413-M50 Master Box (50)

B-0414 Adapter

- Gooseneck coupling
- Converts 3/8" rigid gooseneck to swivel on a 3/8" NPT female outlet faucet



B-0414-M Master Box (2)

EZ-SWIVEL-CZ Swivel Adapter

- Swivel adapter for Chicago and Zurn faucets



EZ-SWIVEL-FM Swivel Adapter

- Swivel adapter for Fisher faucets



B-0411-FXX Swivel to Swivel Adapter

- Swivel to swivel adapter with flow tower
- Includes washer
- Refer to *Flow Tower Chart*, at right, to specify flow desired and add numbers to model suffix
- Use for field conversion where a faucet with a standard swivel outlet requires a swivel flow control outlet
- For use on lavatory faucets to conserve water

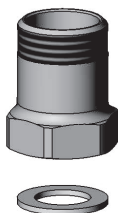

B-0411-FXX Flow Tower Chart

Model No.	Flow (GPM)	Flow Tower Color
B-0411-F10	0.90	Grey
B-0411-F12	1.20	Pink
B-0411-F15	1.40	Green

Conversion Adapters

B-0412-FXX Low Flow Adapter

- Rigid to swivel adapter with flow tower
- Refer to *Flow Tower Chart*, at right, to specify flow desired and add numbers to model suffix
- Use for field conversion where a faucet with 3/8" NPT outlet is installed and a swivel gooseneck or nozzle is required
- For use on lavatory faucets to conserve water



B-0412-FXX Flow Tower Chart		
Model No.	Flow (GPM)	Flow Tower Color
B-0412-F10	1.00	Grey
B-0412-F12	1.20	Orange
B-0412-F15	1.40	Purple
B-0412-F20	2.00	Yellow
B-0412-F05	0.40	Brown

B-1100-K Parts Kit

- Includes 2 each:
1/2" NPT male x female short ELs

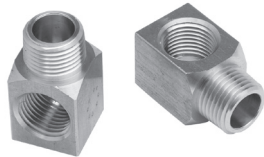

B-0230-KIT Inlet Parts Kit

- Parts included:
2 (017420-45) 24" flexible supply hoses
2 (B-0230-K) 1/2" NPT male elbow installation kit

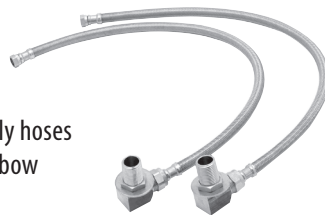

B-0230-K 1/2" NPT Male Elbow Installation Kit

- Includes 2 each:
1/2" NPT supply nipple, lock nut and washer
1/2" NPT male x female short EL

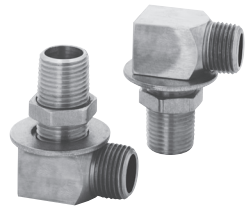

B-0230-K-M12 Master Pack of 12

Inlet Adapters

B-0466 Wall Mount Faucet Adapter For T&S Faucet To Chicago/Zurn Inlets

- Parts included:
(2) Faucet adapters
(1) santoprene seal per adapter
(1) nitrile or EPDM seal per adapter
- 1-3/8" (35 mm) hex nut with internal threads to fit T&S body
- Threads fit Chicago and Zurn inlet flanges



B-0467 Wall Mount Faucet Adapter For T&S Faucet To Fisher Inlets

- Parts included:
(2) Faucet adapters
(2) Santoprene seals per adapter (one each end)
- 1-3/8" (35 mm) swivel hex nut with internal threads to fit T&S body
- Threads fit Fisher inlet flanges



B-0468 Wall-Mount Faucet Adapter For T&S Faucet To Wolverine Brass Inlets

- Parts included:
(2) Faucet adapters
(2) santoprene seals per adapter (one each end)
- 1-3/8" (35 mm) hex nut with internal threads to fit T&S body
- Threads fit Wolverine Brass inlet flanges

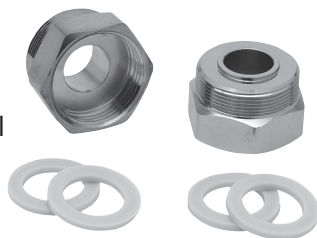

B-0469 Wall Mount Faucet Adapter For T&S Faucet To Krowne Inlets

- Parts included:
(2) Adapters
(1) Coupling nut washer per adapter
(1) Washer, 3/4 I.D. x 15/16 O.D. x 1/8 thick per adapter
- 1-3/8" (35 mm) hex nut with internal threads to fit T&S body
- Threads fit Krowne inlet flanges

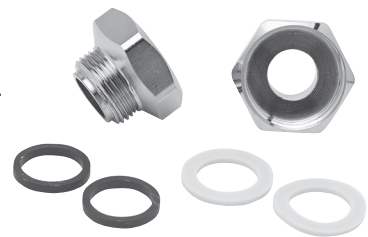



A series of horizontal lines for writing notes, spanning the width of the page.

Hoses

- Stainless steel, PVC and vinyl replacement hoses
- Three-year warranty on all stainless steel (-H) hoses
- See complete list of available hoses on p. ACS29

ACS28

Accessories

B-0044-H Flexible Stainless Steel Hose

- Flexible stainless steel hose and grip handle
- Overall length = 44" (1118 mm)
- Polyurethane inner tubing
- Supplied on most pre-rinse units with overhead spring action gooseneck
- 5/16" hose I.D.



B-0044-H-SWV Flexible Stainless Steel Hose with Pre-Rinse Swivel

NEW MODEL!

- Includes (018200-40) pre-rinse swivel for 360° rotation and grip handle
- Flexible stainless steel hose
- Overall length = 44-15/16" (1141 mm)
- Polyurethane inner tubing
- 5/16" hose I.D.

Note: See Pre-rinse section, p. A7-9 for more information about the swivel



B-0044-R PVC Hose

- PVC hose with grip handle
- Overall length = 44" (1118 mm)
- Extremely durable
- Limited 2 year warranty
- 3/8" hose I.D.



B-0044-V9 Pre-Rinse Hose with Backflow Preventer

- Flexible stainless steel hose and grip handle
- Overall length = 44" (1118 mm)
- Backflow preventer (B-0970-FE) for continuous pressure use
- 5/16" hose I.D.

Note: Not recommended for pre-rinse with overhead spring



013E-36H Flexible Stainless Steel Hose

- Flexible stainless steel hose
- Overall length = 36" (914 mm)
- 1/4" hose I.D.



013E- Hose Models (-H, -R and -V)

For 013E- HOSES/Suffix: H = 7/16" I.D. R = 3/8" I.D. V = 5/16" I.D.

- 013E-36H** 36" Flexible stainless steel hose
- 013E-36R** 36" Reinforced PVC hose
- 013E-48H** 48" Flexible stainless steel hose
- 013E-60H** 60" Flexible stainless steel hose
- 013E-60V** 60" Vinyl hose
- 013E-72H** 72" Flexible stainless steel hose
- 013E-84H** 84" Flexible stainless steel hose

Hose Adapters

Hose Adapter Chart

When specified, these adapters will be provided in place of the 1/2" NPT male adapter normally furnished.

052A 1/4" NPT female	057A 3/4" NPT male
053A 3/8" NPT male (Chicago)	058A 3/4" NPT female
054A 3/8" NPT female	059A Garden Hose female
055A 1/2" NPT male	172A 1/4" NPT male (Fisher)
056A 1/2" NPT female	098A Connect two hoses – includes 2 washers (010476-45)

Hoses

Flexible Stainless Steel, PVC and Vinyl Hoses

For B- HOSES/Suffix: R = 3/8" I.D. H = 5/16" I.D. V = 5/16" I.D.

- B-0015-H** 15" flexible stainless steel hose
- B-0018-H** 18" flexible stainless steel hose
- B-0018-R** 18" reinforced PVC hose
- B-0020-H** 20" flexible stainless steel hose
- B-0020-H2A** 20" flexible stainless steel hose, less grip handle
- B-0020-HM** 20" flexible stainless steel hose Master Box (10)
- B-0020-R** 20" reinforced PVC hose
- B-0023-H** 23" flexible stainless steel hose
- B-0024-H** 24" flexible stainless steel hose
- B-0024-H-SWV** 24" flexible stainless steel hose and pre-rinse swivel
- B-0024-H2A** 24" flexible stainless steel hose, less grip handle
- B-0026-H** 26" flexible stainless steel hose
- B-0026-H2A** 26" flexible stainless steel hose, less grip handle
- B-0026-HM** 26" flexible stainless steel hose Master Box (10)
- B-0028-H** 28" flexible stainless steel hose
- B-0028-H2A** 28" flexible stainless steel hose, less grip handle
- B-0032-H** 32" flexible stainless steel hose
- B-0032-H2A** 32" flexible stainless steel hose, less grip handle
- B-0036-H** 36" flexible stainless steel hose
- B-0036-H-SWV** 36" flexible stainless steel hose and pre-rinse swivel
- B-0036-H2A** 36" flexible stainless steel hose, less grip handle
- B-0040-H2A** 40" flexible stainless steel hose, less grip handle
- B-0042-H2A** 42" flexible stainless steel hose, less grip handle
- B-0044-H** 44" flexible stainless steel hose
- B-0044-H-SWV** 44" flexible stainless steel hose and pre-rinse swivel
- B-0044-H2A** 44" flexible stainless steel hose, less grip handle
- B-0044-H2A-SWV** 44" flexible stainless steel hose, less grip handle with pre-rinse swivel
- B-0044-H2AML** 44" flexible stainless steel hose Master Box (25) less grip handle
- B-0044-H2AMS** 44" flexible stainless steel hose Master Box (10) less grip handle
- B-0044-HF** 44" flexible stainless steel hose with 1/4" NPT male Fisher adapter
- B-0044-HML** 44" flexible stainless steel hose Master Box (25)
- B-0044-HMS** 44" flexible stainless steel hose Master Box (10)
- B-0044-R** 44" reinforced PVC hose
- B-0044-R2A** 44" reinforced PVC hose less grip handle
- B-0044-RML** 44" reinforced PVC hose Master Box (25)
- B-0044-RMS** 44" reinforced PVC hose Master Box (10)
- B-0044-RV9** 44" reinforced PVC hose with B-9670-FE Vacuum breaker
- B-0044-V** 44" vinyl hose
- B-0044-V9** 44" vinyl hose with vacuum breaker
- B-0048-H** 48" flexible stainless steel hose
- B-0050-H** 50" flexible stainless steel hose
- B-0050-H2A** 50" flexible stainless steel hose, less grip handle
- B-0054-H** 54" flexible stainless steel hose
- B-0054-H2A** 54" flexible stainless steel hose, less grip handle
- B-0054-V** 54" vinyl hose
- B-0056-H** 56" flexible stainless steel hose
- B-0056-H2A** 56" flexible stainless steel hose, less grip handle
- B-0056-HMS** 56" flexible stainless steel hose Master Box (10)
- B-0060-H** 60" flexible stainless steel hose
- B-0066-H2A** 66" flexible stainless steel hose, less grip handle
- B-0068-H** 68" flexible stainless steel hose
- B-0068-H-SWV** 68" flexible stainless steel hose and pre-rinse swivel
- B-0068-H2A** 68" flexible stainless steel hose, less grip handle
- B-0068-HML** 68" flexible stainless steel hose Master Box (25)
- B-0068-HMS** 68" flexible stainless steel hose Master Box (10)
- B-0068-R** 68" reinforced PVC hose
- B-0072-H** 72" flexible stainless steel hose
- B-0080-H** 80" flexible stainless steel hose
- B-0084-H** 84" flexible stainless steel hose
- B-0084-V** 84" vinyl hose
- B-0096-H** 96" flexible stainless steel hose
- B-0104-H** 104" flexible stainless steel hose
- B-0108-HOSE** 108" flexible stainless steel hose
- B-0144-H** 144" flexible stainless steel hose

Definitions and Use

T&S Water Conservation Products



Aerator Outlets

Faucet aerators introduce air into the water stream to produce a larger white stream soft to the touch and non-splashing. (See page 10).



Laminar Flow Outlets

Laminar flow (laminar stream) straighteners produce a non-aerated water stream. Ideal for high flow applications or healthcare facilities (no mix water/air). Laminar spout-end devices deliver a crystal clear and non-splashing stream. (See page 11).



Non-Aerated Spray Outlets

When the flow rate is too low to produce an aerated or laminar stream, a spray device is used to produce a miniature shower pattern to provide full coverage of the hands during washing. Sprays are recommended for use in public lavatories. (See page 11).



Plain End Outlets with Flow Control

Plain-end nozzles are unthreaded at the outlet area to prevent the usage of aerators or other screw-on devices, so the maximum flow rate permissible by code or job specification must be controlled by other means. T&S Brass recommends that a flow control disc (available in various flow rates) be installed in the base of the nozzle to achieve maximum customer satisfaction.



RELIABILITY BUILT IN™

G-12

A *Pre-Rinse Units*



Pre-Rinse Units – A

INTRODUCTORY PAGES / FEATURED T&S PRODUCTS:

- EasyInstall Pre-Rinse Units/Features A3
- Pre-Rinse Unit Parts /Accessories Reference A4
- B-0107-J Spray Valve with 1.07 GPM A5
- T&S Low Profile Pre-Rinse Units A6
- T&S Swivel for Pre-Rinse Units and Spray Assemblies (018200-40) A7-9
- DuraPull Pull-Down Pre-Rinse Units A10-11
- B-5100 Series Workboard Base Faucet Pre-Rinse Units A12

018200-40 Swivel for PRUs and Spray Assemblies **A7-9, 56**

NEW! DuraPull Pull-Down Pre-Rinse Units **A10-11**

NEW! B-5100 Series Workboard Pre-Rinse Units **A12-14**

B-0113 Single Hole Deck Mount Mixing Base Faucet Pre-Rinse Units **A15-19**

- B-0113-08 and B-0113-08C Series A15
- B-0113-C, B-0113-BC and B-0107-J A16-17
- B-0113-B Series A18-19

B-0123 8" Deck Mount Mixing Base Faucet Pre-Rinse Units **A20-22**

- B-0123-08 and B-0123-08C Series A20
- B-0123-C, B-0123-BC and B-0107-J A21
- B-0123-B Series A22

TIP

- Find this section's Parts and Repair Kits in the **Parts Kits section (G)**.
- Find Hoses and other accessories for the models in this section in the **Accessories section (ACS)**.

NOTE:
 A comprehensive Index By Model or Part Number and Page can be found in the G-12 General Product Catalog Master Index section (IN).

B-0133 8" Wall Mount Base Faucet Pre-Rinse Units **A24-30**

- B-0133-08 and B-0133-08C Series A24-25
- B-0133-B Series A26-27
- B-0133-C and B-0107-J A28-29
- B-2278 Series A30

Other T&S Pre-Rinse Units **A31-42**

- Overhead Spring Pre-Rinse Units A34
- Overhead Swivel Arm Pre-Rinse Units A35-37
- Roto-Flex Design Pre-Rinse Units A38-39
- Overhead Swivel with Balancing Unit A40-41
- Big Flo Pre-Rinse Units A42

Spray Valve, Faucet and Hose Assemblies **A43-50**

- Spray Valve Assemblies A43-45
- Spray Valve Assemblies and Faucets A46-49
- Quick-Connect Spray Assemblies A50

Spray Valves and Pre-Rinse Accessories **A51-57**

- B-0108 Series Ergonomic Spray Valve A51
- Add-On Faucets for Pre-Rinse Units A52
- Spray Valve Comparison Chart A53
- Standard and Low Flow Spray Valves A54-55
- Pre-Rinse Accessories: Wall Brackets, Supply Nipples, Wall Hook Outlets, Vacuum Breakers, Add-On Accessory Tees (Swivel & Rigid) A56-57



? Can't find the T&S product you're looking for?
 Please visit www.tsbrass.com for a complete product listing.



The Superior Features of a T&S **EasyInstall** Pre-Rinse Unit

W



S

B-0107
1.15 GPM
Flow Rate

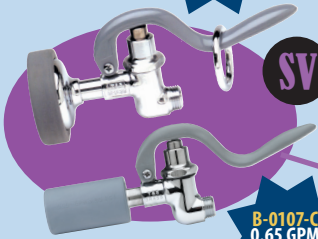

SV

B-0107-C
0.65 GPM
Flow Rate

B-0107-J
1.07 GPM
Flow Rate

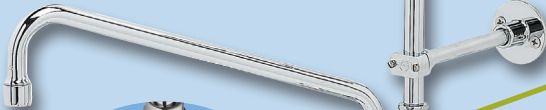

E



F

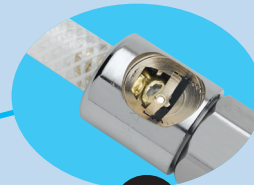

H

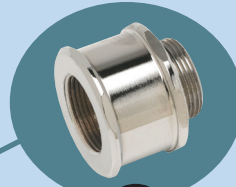

PS



T



C

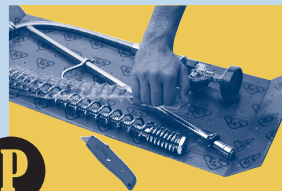

P

EasyInstall

- C** **CARTRIDGES**
 - Interchangeable
 - Self-contained and easily replaced
 - Spring checks or Check valves
- E** **EASYINSTALL**
 - Patented design
 - Unique "pop-and-lock" riser connection that takes as little as 10 minutes to install
- F** **FAUCETS**
 - Forged one-piece base faucet eliminates leaks
 - Copper layer over casting makes smoother surface
 - Thick chrome plating
- H** **HOSES**
 - Stainless steel hoses with double interlocked covers for long life
 - Sealed ends prevent tears
 - Vinyl nylon reinforced inner hose tested to 1200 PSI
- P** **PACKAGING**
 - Pre-assembled parts are ready for quick installation
 - Fewer parts to misplace
- PS** **PRE-RINSE SWIVEL**
 - Provides 360° rotation capability
 - Ergonomic and ultra-smooth
 - Significantly cuts down on user strain and fatigue
- S** **SPRING**
 - Specially designed spring reinforced at the stress point where hose connects
 - Protects and extends life of hose
- SV** **SPRAY VALVES**
 - Significant water savings with low-flow rates
 - Uncompromising performance
 - Tested to over 1.5 million cycles
- T** **ACCESSORY TEE**
 - B-TEE-RGD provides additional water source in kitchen
- W** **WARRANTY**
 - Long three-year warranty on your T&S EasyInstall PRU

A
3

Pre-Rinse Units PARTS & ACCESSORIES **Easy Install**

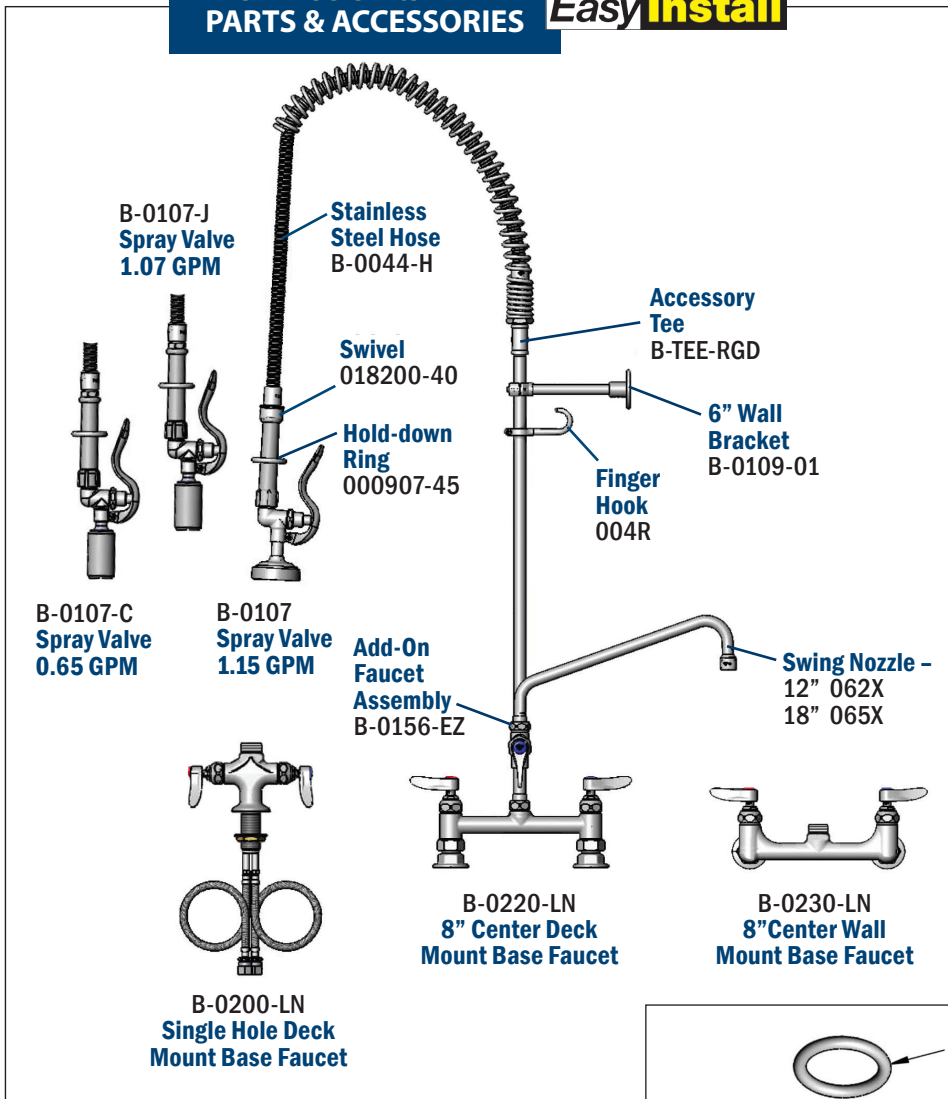

B-0107 Spray Valve EXPLODED VIEW

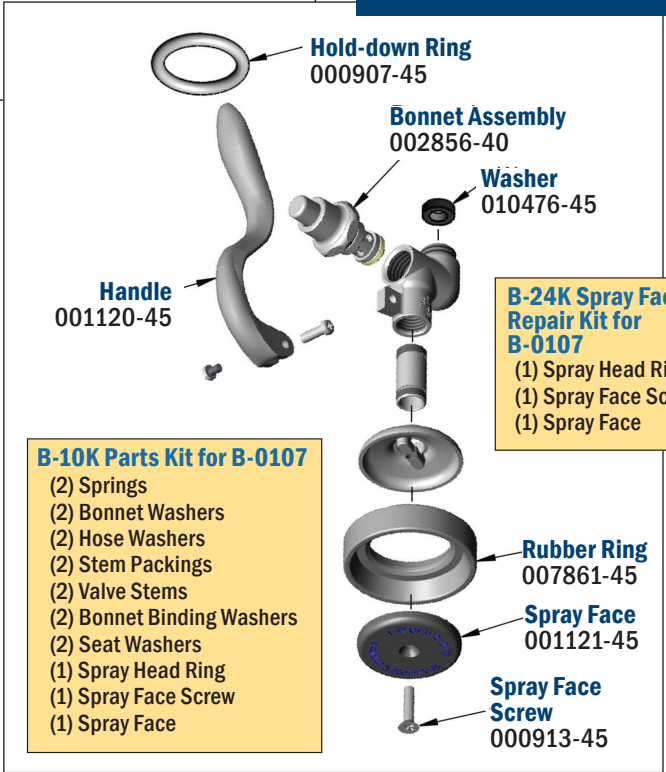

- B-10K Parts Kit for B-0107**
- (2) Springs
 - (2) Bonnet Washers
 - (2) Hose Washers
 - (2) Stem Packings
 - (2) Valve Stems
 - (2) Bonnet Binding Washers
 - (2) Seat Washers
 - (1) Spray Head Ring
 - (1) Spray Face Screw
 - (1) Spray Face

Pre-Rinse Units OTHER ACCESSORIES

018200-40
 Pre-Rinse Swivel
 360° rotation for pre-rinse spray valves



B-TEE-RGD
 Pre-Rinse Accessory Tee



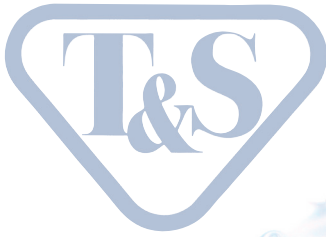

Helping You Save Money.

One Gallon at a Time.

The B-0107-J
Low Flow Spray Valve has
CLEANING POWER!

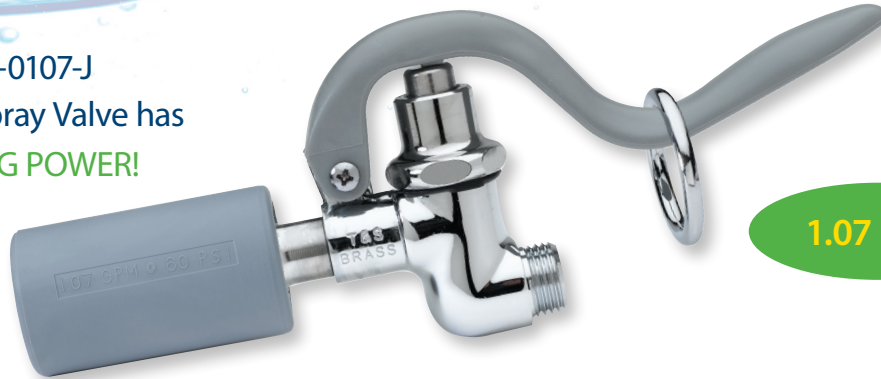

1.07 GPM

**A
5**

Check out the B-0107-J with a 1.07 GPM Flow Rate

The T&S Brass B-0107-J low flow spray valve features significant water- and energy-savings while making pre-rinse tasks easier. With its powerful cleaning capability, tough baked-on foods will come off faster when using the B-0107-J. It is built to withstand all that a commercial kitchen dishes out on a daily basis, along with T&S's reputation for durability and reliability.

B-0107-J features:

- Its intensified power rinsing quickly gets rid of tough baked-on foods
- It consumes 33% less water than other DOE 2019 compliant valves (at 1.6 GPM)
- NSF 372 & ANSI/NSF Standard 61 compliant
- T&S's quality, reliability and performance
- Is interchangeable with Fisher spray valves

Model	Description
B-0107-J	1.07 GPM Low-Flow Spray Valve
B-0107-J90	1.07 GPM 90° Angled Low-Flow Spray Valve
B-0107-J-SWV	1.07 GPM Low-Flow Spray Valve with Pre-Rinse Swivel

See pages A54-55 for more information about these low-flow spray valves

Other Water-Saving Spray Valves in the T&S B-0107-C Family



The B-0107-C is endorsed by the Green Restaurant Association (GRA), which recommends environmentally responsible products for the restaurant industry.



B-0107-C

B-0107-C35

Model	Description
B-0107-C	0.65 GPM Ultimate Low-Flow Spray Valve
B-0107-C35	0.65 GPM Ultimate 35° Angled Low-Flow Spray Valve
B-0107-C90	0.65 GPM Ultimate 90° Angled Low-Flow Spray Valve

See pages A54-55 for more information about these low-flow spray valves

The T&S Brass **EasyInstall** Low Profile Pre-Rinse Line



The T&S Pre-Rinse Solution For Limited Kitchen Space

In 1947, we introduced the market's first pre-rinse unit to the foodservice industry. Today, T&S pre-rinse units remain the industry standard.

Leading the way in innovation, we are pleased to introduce our new line of T&S Low Profile Pre-Rinse Units, designed to fit in compact kitchens and in tight spaces.

All T&S Low Profile Pre-Rinse Units include many of the same high-quality components and features you already find with our standard-sized pre-rinses:

- EasyInstall design saves significant installation time
- B-0109-01 6" Wall Bracket for added stability
- Add-On Faucet with Swing Nozzle for pot and kettle filling convenience
- 2019 DOE Compliant water-conserving Pre-Rinse Spray Valves

- Wall- or deck-mount Base Faucet with your choice of Cerama or Compression Cartridges
- Compact Spring with Flexible Stainless Steel Hose and Finger Hook

Customizing Made Easy

Options available for each T&S Low Profile Pre-Rinse Unit allow you to order exactly what you need.



Examples of Available Models

MPY-2DCN-06 – Single deck-mount base faucet, add-on faucet, 6" swing nozzle, compact spring and hose, B-0107-C spray valve, 6" wall bracket, club handles

MPZ-2DCN-06 – Single deck-mount base faucet, add-on faucet, 6" swing nozzle, compact spring and hose, B-0107 spray valve, 6" wall bracket, club handles

MPZ-2DLN-06 – Single deck-mount base faucet, add-on faucet, 6" swing nozzle, compact spring and hose, B-0107 spray valve, 6" wall bracket, lever handles

MPZ-8WCN-06 – 8" Wall-mount mixing faucet, add-on faucet, 6" swing nozzle, compact spring and hose, B-0107 spray valve, 6" wall bracket, club handles

MPZ-8WLN-06 – 8" Wall-mount mixing faucet, add-on faucet, 6" swing nozzle, compact spring and hose, B-0107 spray valve, 6" wall bracket, lever handles

NEW KITS!

MPZ-KIT-LN06 Retrofit kit with B-0107, Eterna cartridges, add-on faucet with 6" swing nozzle and lever handles

MPZ-KIT-LN06-CR Retrofit kit with B-0107, Cerama cartridges, add-on faucet with 6" swing nozzle and lever handles



Low Profile Pre-Rinse Unit Configurator – Build Your Own Low Profile Pre-Rinse!

MP

Spray Valve	PRU Body	Handle	Add-On Faucet Nozzle	Cerama Cartridge
Z B-0107	2D Single Hole Base (B-0113 style)	L Lever	06 6" Swing Nozzle	CR Cerama cartridge
Y B-0107-C	8D Deck mount with 8" centers (B-0123 style)	W 4" Wrist Action	08 8" Swing Nozzle	Note: The Eterna compression cartridge is the default cartridge installed in the Low Profile Pre-Rinse Unit.
X B-0107-035	8W Wall Mount with 8" centers (B-0133 style)	C Club (decorative)		
W B-0107-C35				
L B-0107-J35				
J B-0107-J				
			Vacuum Breaker	
			V Atmospheric Vacuum Breaker (B-0970-FEZ)	
			N No Vacuum Breaker	

“What Could Make Our Customer's Work Easier – and Save Them Money?”

That is the question the T&S foodservice product engineering team considered before it ultimately designed the new T&S Pre-Rinse Swivel (018200-40).

In a busy commercial kitchen, we saw the need for a simple, ergonomic device, either already installed or easily retrofitted between a spray handle and hose. The T&S Pre-Rinse Swivel most importantly gives you full 360° rotation capability while using your spray assembly or pre-rinse unit spray valve.

The swivel's unimpeded and ultra smooth rotation significantly cuts down on strain and fatigue on the user's wrist and joints, not to mention extends the life of the pre-rinse hose and spray. And because you won't spend time wrestling with a pre-rinse spray valve that doesn't rotate the way you may want it to, it will ultimately save you time, water and money.

The Pre-Rinse Swivel is also factory installed on select T&S Pre-Rinse Units and Spray Assemblies (see the chart below for available models). The T&S Pre-Rinse Swivel works seamlessly with all T&S, Equip and many other manufacturer's Spray Valve models.



You won't spend extra time wrestling with a pre-rinse spray valve that doesn't do what you want it to do.

Result: The T&S Pre-Rinse Swivel will ultimately save you time, water and money.

A
7

SAVE ENERGY
WATER
MONEY

T&S Pre-Rinse Swivel MODELS

Model	Description
018200-40	Pre-Rinse Swivel Kit with (2) washers for retrofit installations (shown, p. A8)
B-0036-H-SWV	36" flexible stainless steel hose and Swivel ¾-14 Female
B-0044-H-SWV	44" flexible stainless steel hose and Swivel ¾-14 Female
B-0044-H2A-SWV	44" flexible stainless steel hose, less handle and Swivel ¾-14 Female
B-0068-H-SWV	68" flexible stainless steel hose and Swivel ¾-14 Female
B-0100-SWV	B-0107 Spray Valve (1.15 GPM) with B-0044-H flexible stainless steel hose and Swivel ½" NPT Male (shown, p. A8)
B-0100-C-SWV	B-0107-C Low-Flow Spray Valve (0.65 GPM) with B-0044-H flexible stainless steel hose and Swivel ½" NPT Male (shown, p. A8)
B-0100-J-SWV	B-0107-J Low-Flow Spray Valve (1.07 GPM) with B-0044-H flexible stainless steel hose and Swivel ½" NPT Male (shown, p. A8)
B-0113-B-SWV Easy Install	EasyInstall Pre-Rinse Unit, single deck-mount faucet, B-0107 (1.15 GPM) spray valve with Swivel, wall bracket (shown, p. A8)
B-0113-SWV Easy Install	EasyInstall Pre-Rinse Unit, single deck-mount faucet, B-0107 (1.15 GPM) spray valve with Swivel
B-0133-B-SWV Easy Install	EasyInstall Pre-Rinse Unit, 8" C/C wall-mount mixing faucet, B-0107 (1.15 GPM) spray valve, Swivel, wall bracket
B-0133-SWV Easy Install	EasyInstall Pre-Rinse Unit, 8" C/C wall-mount mixing faucet, B-0107 (1.15 GPM) spray valve with Swivel
B-0133-B08-SWV Easy Install	EasyInstall Pre-Rinse Unit, 8" C/C wall-mount mixing faucet, B-0108 (1.07 GPM) JeTSpray valve with Swivel
B-0133-CR-B8SWX Easy Install	EasyInstall Pre-Rinse Unit, 8" C/C wall-mount mixing faucet, Cerama cartridges, B-0108 (1.07 GPM) JeTSpray valve with Swivel, wall bracket, club handles

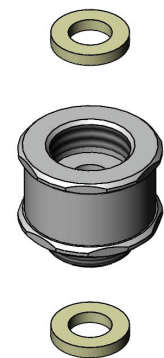

018200-40
Pre-Rinse Swivel Kit includes (2) Washers

Available for retrofit installations

The T&S *Pre-Rinse Swivel*



RELIABILITY BUILT IN™

FEATURES and BENEFITS

- Solid heavy-duty construction – robust and long-lasting
- Stainless steel concealed ball bearings provide ultra-smooth operation and will not corrode
- Chrome plated brass finish is durable and will not rust
- Spray valve with handle rotates easily and independently from the hose
- Its ergonomic design puts less stress on the wrist and joints
- Less torque being put on the hose and handle means it is less prone to breakage or failure
- It can be conveniently retrofitted on all T&S and Equip hose assemblies and many other major manufacturer's models
- Retrofit installation is easily done with a 5/16" hex wrench; the pre-rinse swivel (018200-40) includes two replacement washers (see p.A9 for installation)
- All T&S Pre-Rinse Swivel models fully comply with:
 - ASME A112.18.1 / CSA B125.1
 - ANSI/NSF 61 - Section 9
 - California Health and Safety Code 116875 (AB1953-2006)
 - NSF/ANSI 372 ~ Low Lead Content (0.25% Max)
 - DOE 2019

A
8

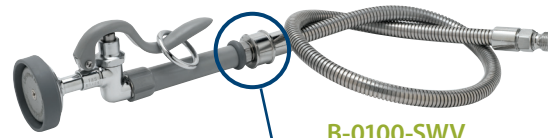

B-0100-SWV
Spray Assembly



018200-40
Pre-Rinse Swivel

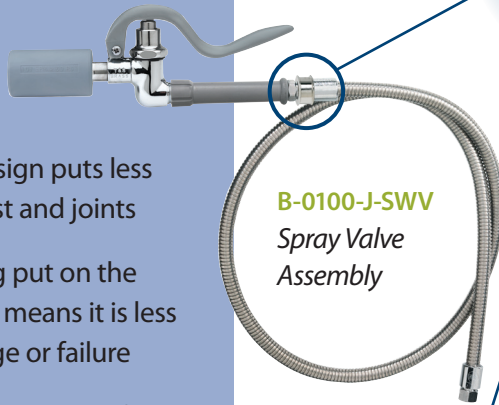

B-0100-J-SWV
Spray Valve Assembly



B-0100-C-SWV
Spray Valve Assembly

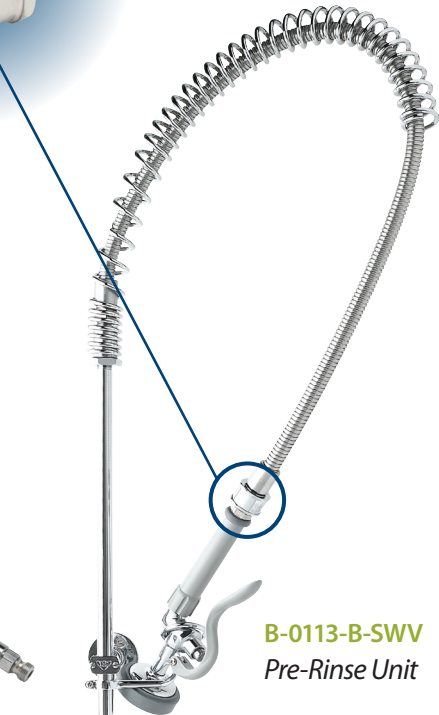

B-0113-B-SWV
Pre-Rinse Unit

Easy Install



How Do I Add the T&S Pre-Rinse Swivel...

...to my Pre-Rinse Spray Valve?

The T&S Pre-Rinse Swivel RETROFIT INSTALLATION

1. Unscrew the gray handle from the hose (see exploded view, below) and place a new (001014-45) washer in the hose barrel.
2. Start threading the male end of the pre-rinse swivel to the hose. With a 5/16" hex L-key firmly tighten the pre-rinse swivel to the hose.
3. Place the second washer (001014-45) in the pre-rinse swivel end and screw the spray valve handle* into the pre-rinse swivel. Tighten firmly.

* If you have a B-0108 series spray valve, tighten the pre-rinse swivel directly to the spray valve.



B-0100-SWV



B-0100-C-SWV

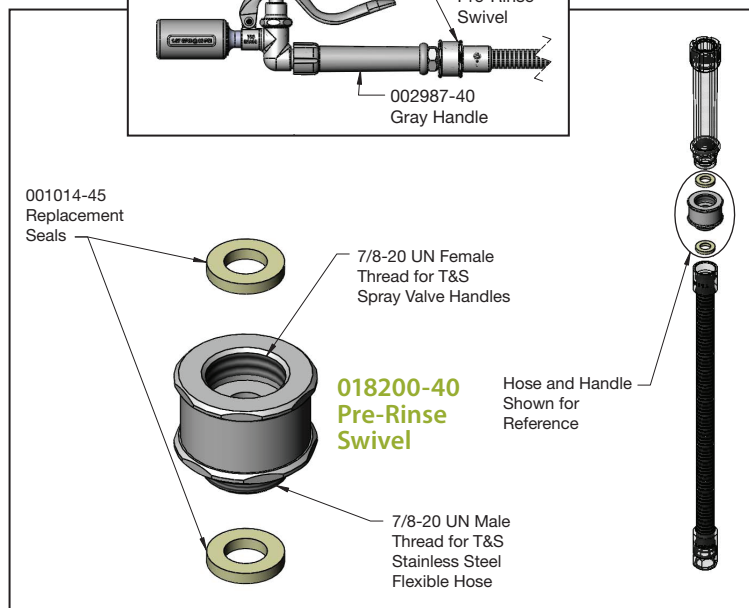
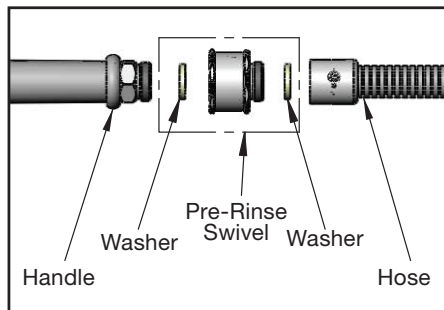
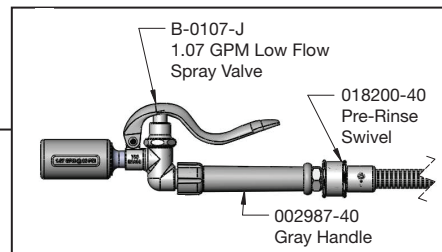

T&S Brass and Bronze Works, Inc.
www.tsbrass.com

2 Saddleback Cove • P.O. Box 1088 • Travelers Rest, SC 29690
Phone 800.476.4103 • Fax 864.834.3518



Meet the Newest T&S Pre-Rinse Line!

Our Pull Down Pre-Rinse Units Are the Latest in T&S Innovations

When high volume demands the highest performance, T&S delivers an all-new line of reliable pre-rinse units. With a premium design that feels right at home in any high-end kitchen, each T&S pre-rinse unit offers pull-down activation that allows users to easily switch water flow on and off.

Not only does the unit's pull-down activation and automatic shut-off function reduce stress and fatigue on the operator, it also eliminates the spray valve handle and hold-down ring – making it easy to conserve water.

NEW! T&S Pull Down Pre-Rinse Unit Models

Model	Mount	Cartridge	Add-On Fct.	Tee
B-0113-CR-B8P	Single hole	Cerama	N	N
B-0113-12-CRB8P	Single hole	Cerama	Y*	N
B-0123-CR-B8P	8" Deck	Cerama	N	N
B-0123-12-CRB8P	8" Deck	Cerama	Y*	N
B-0133-CR-B8P	8" Wall	Cerama	N	N
B-0133-12-CRB8P	8" Wall	Cerama	Y*	N
B-0113-CR-B8TP	Single hole	Cerama	N	Y
B-0113-12-CRB8TP	Single hole	Cerama	Y*	Y
B-0123-CR-B8TP	8" Deck	Cerama	N	Y
B-0123-12-CRB8TP	8" Deck	Cerama	Y*	Y
B-0133-CR-B8TP	8" Wall	Cerama	N	Y
B-0133-12-CRB8TP	8" Wall	Cerama	Y*	Y
B-5110-CR-B8P	4" Deck	Cerama	N	N
B-5110-12-CRB8P	4" Deck	Cerama	Y*	N
B-5115-CR-B8P	4" Wall	Cerama	N	N
B-5115-12-CRB8P	4" Wall	Cerama	Y*	N
B-5120-CR-B8P	8" Deck	Cerama	N	N
B-5120-12-CRB8P	8" Deck	Cerama	Y*	N
B-5125-CR-B8P	8" Wall	Cerama	N	N
B-5125-12-CRB8P	8" Wall	Cerama	Y*	N
B-5110-CR-B8TP	4" Deck	Cerama	N	Y
B-5110-12-CRB8TP	4" Deck	Cerama	Y*	Y
B-5115-CR-B8TP	4" Wall	Cerama	N	Y
B-5115-12-CRB8TP	4" Wall	Cerama	Y*	Y
B-5120-CR-B8TP	8" Deck	Cerama	N	Y
B-5120-12-CRB8TP	8" Deck	Cerama	Y*	Y
B-5125-CR-B8TP	8" Wall	Cerama	N	Y
B-5125-12-CRB8TP	8" Wall	Cerama	Y*	Y

* All Add-On Faucets include a 12" swing nozzle

DURAPULL



1.07 GPM JeTSpray
flow rate meets
2019 DOE regulations

B-0113-12-CRB8P

Pull Down Pre-Rinse Unit

EasyInstall



ALL PULL DOWN MODELS FEATURE:

- Dual temperature
- Cerama cartridges
- JeTSpray (1.07 GPM)
- Pull down activation and automatic shut-off

DURAPULL



B-0133-12-CRB8P

Pull Down Pre-Rinse Unit

EasyInstall



Workboard Pre-Rinses: **Another T&S Innovation!**

Our B-5100 Series Workboard Pre-Rinse Units Come With Many Updated Features

**B-5120-B
Workboard
Pre-Rinse Unit**

NEW!
EasyInstall



New!
EasyInstall
"Pop and Lock"
riser installation



New!
Redesigned
bonnet,
handles, indexes

**B-5125-12-BJ
Workboard
Pre-Rinse Unit**

NEW!
EasyInstall

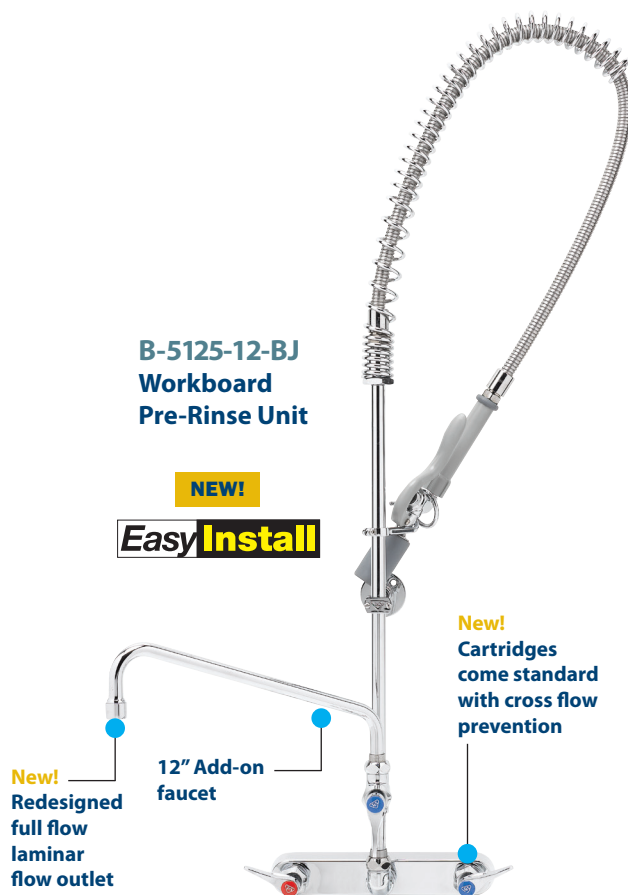

New!
Redesigned
full flow
laminar
flow outlet

**12" Add-on
faucet**

New!
Cartridges
come standard
with cross flow
prevention

Introducing our **NEW EasyInstall Workboard Pre-Rinse Assemblies!**

This new family of T&S pre-rinse units is based on our very popular B-1100 workboard faucet line.

This new line has the same high-quality features you find in all T&S pre-rinse units, including:

- A new, modern design for T&S bonnets, handles and indexes
- A redesigned full flow laminar flow outlet
- Cerama or Eterna cartridges that come standard with cross flow prevention
- DOE 2019 Compliant low flow spray valves
- EasyInstall "Pop and Lock" riser installation that makes installation fast and easy

NEW! Workboard Pre-Rinse Unit Models

Model	Mount	Cartridge	12" ADF	Spray Valve
B-5125-12-B	8" Wall	Eterna	Y	B-0107
B-5125-12-BJ	8" Wall	Eterna	Y	B-0107-J
B-5125-B	8" Wall	Eterna	N	B-0107
B-5125-BJ	8" Wall	Eterna	N	B-0107-J
B-5125-12-CR-B	8" Wall	Cerama	Y	B-0107
B-5125-12-CRBJ	8" Wall	Cerama	Y	B-0107-J
B-5125-CR-B	8" Wall	Cerama	N	B-0107
B-5125-CR-BJ	8" Wall	Cerama	N	B-0107-J
B-5120-12-B	8" Deck	Eterna	Y	B-0107
B-5120-12-BJ	8" Deck	Eterna	Y	B-0107-J
B-5120-B	8" Deck	Eterna	N	B-0107
B-5120-BJ	8" Deck	Eterna	N	B-0107-J
B-5120-12-CR-B	8" Deck	Cerama	Y	B-0107
B-5120-12-CRBJ	8" Deck	Cerama	Y	B-0107-J
B-5120-CR-B	8" Deck	Cerama	N	B-0107
B-5120-CR-BJ	8" Deck	Cerama	N	B-0107-J

NEW! Low Profile Workboard Pre-Rinse Unit Models

Model	Mount	Cartridge	8" ADF	Spray Valve
MPJ-4CLN-08-CR	4" Deck	Cerama	Y	B-0107-J
MPJ-8CLN-08-CR	8" Deck	Cerama	Y	B-0107-J

All Pre-rinse Units listed above are standard with lever handles and a B-0109-01 6" wall bracket

B-5120 series deck mount workboard pre-rinse units with the B-0107 (1.15 GPM) and B-0107-J (1.07 GPM) spray valves feature:

- B-0107 and B-0107-J spray valves are powerful and efficient
- All workboard pre-rinse units are equipped with quarter-turn cartridges including cross flow prevention
- Hot Eterna Cartridge – 012443-40NS • Cold Eterna Cartridge – 012442-40NS
- Hot Cerama Cartridge – 012394-25NS • Cold Cerama Cartridge – 012395-25NS

B-5120-B Workboard Pre-Rinse Unit

- B-0107 Spray Valve (1.15 GPM)
- B-0107-J Low Flow JetSpray Valve (1.07 GPM)

- 8" center deck mount workboard faucet with EasyInstall™ "pop and lock" riser installation feature – pre-assembled parts
- Quarter-turn cartridges with cross flow prevention
- B-0107 spray valve
- Redesigned lever handles with new indexes
- ½" NPT male inlets
- B-0044-H flexible stainless steel hose with handle

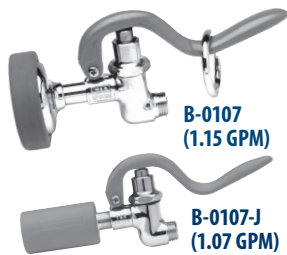

EasyInstall

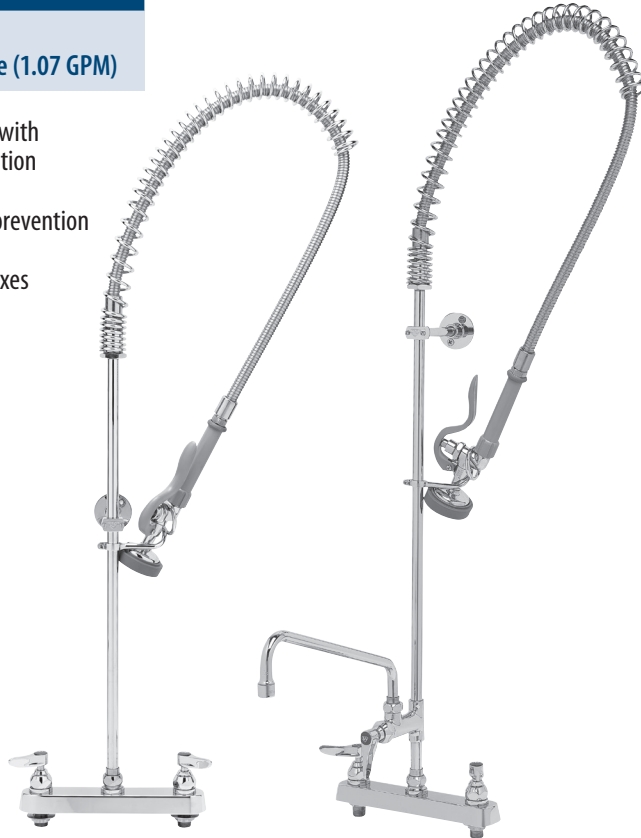

B-5120-B

B-5120-12-CR-B

MPJ-4CLN-08-CR Low Profile Pre-Rinse Unit

EasyInstall



- 4" center deck mount base faucet
- 8" swing nozzle with add-on faucet
- Compact spring and hose
- Low flow spray valve (B-0107-J)
- Wall bracket (B-0109-01)
- Low profile fits in limited kitchen spaces
- Redesigned lever handles, indexes and bonnet

MPJ-8CLN-08-CR same as MPJ-4CLN-08-CR except with 8" deck mount base faucet

B-5120 WORKBOARD FAUCET PRU	1/4-Turn CARTRIDGE w/Cross Flow Prevention	SPRAY VALVE / GPM	WALL BRACKET	ADD-ON FAUCET	NOZZLE LENGTH	OVERALL HEIGHT	NOTES
B-5120-B	Eterna	B-0107 (1.15 GPM)	B-0109-01 (6")	N	–	39-15/16" (1014 mm)	See photo above
B-5120-BJ	Eterna	B-0107-J (0.65 GPM)	B-0109-01 (6")	N	–	39-15/16" (1014 mm)	
B-5120-CR-B	Cerama	B-0107 (1.15 GPM)	B-0109-01 (6")	N	–	39-15/16" (1014 mm)	
B-5120-CR-BJ	Cerama	B-0107-J (1.07 GPM)	B-0109-01 (6")	N	–	39-15/16" (1014 mm)	
Add-On Faucet Models:							
B-5120-12-B	Eterna	B-0107 (1.15 GPM)	B-0109-01 (6")	Y	12" (305 mm)	44-1/8" (1122 mm)	
B-5120-12-BJ	Eterna	B-0107-J (1.07 GPM)	B-0109-01 (6")	Y	12" (305 mm)	44-1/8" (1122 mm)	
B-5120-12-CR-B	Cerama	B-0107 (1.15 GPM)	B-0109-01 (6")	Y	12" (305 mm)	44-1/8" (1122 mm)	See photo above
B-5120-12-CRBJ	Cerama	B-0107-J (1.07 GPM)	B-0109-01 (6")	Y	12" (305 mm)	44-1/8" (1122 mm)	
Low Profile Models:							
MPJ-4CLN-08-CR	Cerama	B-0107-J (1.07 GPM)	B-0109-01 (6")	Y	8" (204 mm)	22-11/16" (576 mm)	See photo above
MPJ-8CLN-08-CR	Cerama	B-0107-J (1.07 GPM)	B-0109-01 (6")	Y	8" (204 mm)	22-11/16" (576 mm)	

B-5125 series wall mount workboard pre-rinse units with the B-0107 (1.15 GPM) and B-0107-J (1.07 GPM) spray valves feature:

- B-0107 and B-0107-J spray valves are powerful and efficient
- All workboard pre-rinse units are equipped with quarter-turn cartridges including cross flow prevention
- Hot Eterna Cartridge – 012442-40NS • Cold Eterna Cartridge – 012443-40NS
- Hot Cerama Cartridge – 012395-25NS • Cold Cerama Cartridge – 012394-25NS

**B-5125-B
Workboard Pre-Rinse Unit**

B-0107 Spray Valve (1.15 GPM)
B-0107-J Low Flow Spray Valve (1.07 GPM)

Easy Install

**A
14**

- 8" center wall mount workboard faucet with EasyInstall™ "pop and lock" riser installation feature – pre-assembled parts
- Quarter-turn cartridges with cross flow prevention
- B-0107 spray valve
- Redesigned lever handles with new indexes
- ½" NPT male inlets
- B-0044-H flexible stainless steel hose with handle

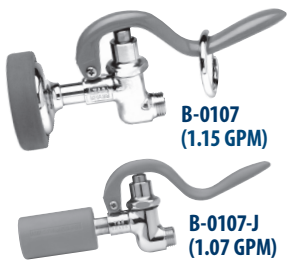

B-5125-B

B-5125-12-CRBJ

B-5125 WORKBOARD FAUCET PRU	1/4-Turn CARTRIDGE w/Cross Flow Prevention	SPRAY VALVE / GPM	WALL BRACKET	ADD-ON FAUCET	NOZZLE LENGTH	OVERALL HEIGHT	NOTES
B-5125-B	Eterna	B-0107 (1.15 GPM)	B-0109-01 (6")	N	–	33-3/16" (843 mm)	See photo above
B-5125-BJ	Eterna	B-0107-J (1.07 GPM)	B-0109-01 (6")	N	–	33-3/16" (843 mm)	
B-5125-CR-B	Cerama	B-0107 (1.15 GPM)	B-0109-01 (6")	N	–	33-3/16" (843 mm)	
B-5125-CR-BJ	Cerama	B-0107-J (1.07 GPM)	B-0109-01 (6")	N	–	33-3/16" (843 mm)	
Add-On Faucet Models:							
B-5125-12-B	Eterna	B-0107 (1.15 GPM)	B-0109-01 (6")	Y	12" (305 mm)	37-7/16" (951 mm)	
B-5125-12-BJ	Eterna	B-0107-J (1.07 GPM)	B-0109-01 (6")	Y	12" (305 mm)	37-7/16" (951 mm)	
B-5125-12-CR-B	Cerama	B-0107 (1.15 GPM)	B-0109-01 (6")	Y	12" (305 mm)	37-7/16" (951 mm)	
B-5125-12-CRBJ	Cerama	B-0107-J (1.07 GPM)	B-0109-01 (6")	Y	12" (305 mm)	37-7/16" (951 mm)	See photo above



B-0113 series pre-rinse units with the B-0108 (1.07 GPM) and B-0108-C (0.65 GPM) JeTSpray valves feature:

- Ergonomic B-0108 and B-0108-C JeTSpray valves are powerful and efficient
- All pre-rinse units are equipped with quarter-turn cartridges including cross flow prevention
- Hot Eterna Cartridge – 012443-40NS • Cold Eterna Cartridge – 012442-40NS

B-0113-08 and B-0113-08C Pre-Rinse Units

- B-0108 JeTSpray Valve (1.07 GPM)
- B-0108-C Low Flow JeTSpray Valve (0.65 GPM)

Easy Install

- Single hole deck mount base faucet assembly (B-0200-LN) with EasyInstall™ “pop and lock” riser installation feature
- Overhead spring
- 18” (457 mm) flexible inlets with 5/8” compression / 1/2” NPSM male couplings
- Quarter-turn cartridges with cross flow prevention
- 24” (610 mm) riser (000372-40)
- B-0044-H2A 44” flexible stainless steel hose
- Finger hook (004R)



B-0113-B08

**A
15**

B-0113 BASE FAUCET PRU	1/4-Turn CARTRIDGE w/Cross Flow Prevention	SPRAY VALVE / GPM	WALL BRACKET	ADD-ON FAUCET	NOZZLE LENGTH	OVERALL HEIGHT	NOTES
B-0113-08	Eterna	B-0108 (1.07 GPM)	N	N	–	42-1/16” (1068 mm)	
B-0113-08C	Eterna	B-0108-C (0.65 GPM)	N	N	–	42-1/16” (1068 mm)	
B-0113-B08	Eterna	B-0108 (1.07 GPM)	B-0109-01 (6”)	N	–	42-1/16” (1068 mm)	See photo above
B-0113-B08C	Eterna	B-0108-C (0.65 GPM)	B-0109-01 (6”)	N	–	42-1/16” (1068 mm)	
Add-On Faucet Models:							
B-0113-A06-08	Eterna	B-0108 (1.07 GPM)	N	Y	6” (152 mm)	46-1/4” (1175 mm)	
B-0113-A06-B08	Eterna	B-0108 (1.07 GPM)	B-0109-01 (6”)	Y	6” (152 mm)	46-1/4” (1175 mm)	
B-0113-A06-B08C	Eterna	B-0108-C (0.65 GPM)	B-0109-01 (6”)	Y	6” (152 mm)	46-1/4” (1175 mm)	
B-0113-A10-08C	Eterna	B-0108-C (0.65 GPM)	N	Y	10” (254 mm)	46-1/4” (1175 mm)	
B-0113-A12-B08	Eterna	B-0108 (1.07 GPM)	B-0109-01 (6”)	Y	12” (305 mm)	46-1/4” (1175 mm)	
B-0113-A12-08C	Eterna	B-0108-C (0.65 GPM)	N	Y	12” (305 mm)	46-1/4” (1175 mm)	See photo above
B-0113-A12-B08C	Eterna	B-0108-C (0.65 GPM)	B-0109-01 (6”)	Y	12” (305 mm)	46-1/4” (1175 mm)	



B-0113 series pre-rinse units with the B-0107-C (0.65 GPM) and B-0107-J (1.07 GPM) low flow spray valves feature:

- B-0107-C and B-0107-J spray valves are powerful and efficient
- All pre-rinse units are equipped with quarter-turn cartridges including cross flow prevention
- Hot Eterna Cartridge – 012443-40NS • Cold Eterna Cartridge – 012442-40NS
- Hot Cerama Cartridge – 012394-25NS • Cold Cerama Cartridge – 012395-25NS

B-0113-C and B-0113-J Pre-Rinse Units

Easy Install

- B-0107-C Ultimate Low Flow Spray Valve (0.65 GPM)
- B-0107-J Low Flow Spray Valve (1.07 GPM)

**A
16**

- Single hole deck mount base faucet assembly (B-0200-LN) with EasyInstall™ "pop and lock" riser installation feature
- Overhead spring
- 18" (457 mm) flexible inlets with 5/8" compression / 1/2" NPSM male couplings
- Quarter-turn cartridges with cross flow prevention
- B-0044-H 44" flexible stainless steel hose
- Finger hook (004R)



B-0113-BC



B-0113-BJ-SWV-T



B-0113-12CRBJST



B-0113 series pre-rinse units with the B-0107 (1.15 GPM) and B-0107-J (1.07 GPM) spray valves feature:

- All pre-rinse units are equipped with quarter-turn cartridges including cross flow prevention
- Hot Eterna Cartridge – 012443-40NS • Cold Eterna Cartridge – 012442-40NS
- Hot Cerama Cartridge – 012394-25NS • Cold Cerama Cartridge – 012395-25NS

B-0113-B Pre-Rinse Units	
B-0107	Spray Valve (1.15 GPM)
B-0107-J	Low Flow Spray Valve (1.07 GPM)

Easy Install



B-0113-B

**A
18**

- Single hole deck mount base faucet assembly (B-0200-LN) with EasyInstall™ "pop and lock" riser installation feature
- Overhead spring
- 18" (457 mm) flexible inlets with 5/8" compression / 1/2" NPSM male couplings
- B-0109-01 6" (152 mm) wall bracket
- Quarter-turn cartridges with cross flow prevention
- B-0044-H 44" flexible stainless steel hose
- Finger hook (004R)

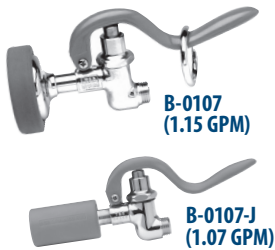

B-0113-ADF12-B



B-0113-B-TEE

Pre-Rinse and Spray Valve Options

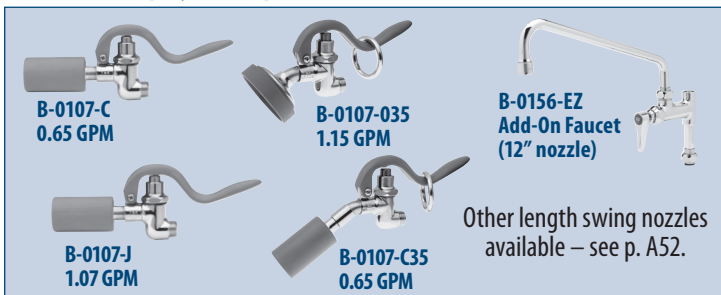

See complete line of pre-rinse accessories on pages A51-57



**B-0113-B
Pre-Rinse Units**

Easy Install

- B-0107 Spray Valve
- B-0107-J Low Flow Spray Valve (1.07 GPM)

B-0113 BASE FAUCET PRU	1/4-Turn CARTRIDGE w/Cross Flow Prevention	SPRAY VALVE / GPM	WALL BRACKET	ADD-ON FAUCET	NOZZLE LENGTH	OVERALL HEIGHT	NOTES
B-0113	Eterna	B-0107 (1.15 GPM)	N	N	—	42-1/16" (1068 mm)	
B-0113-079X-V-B	Eterna	B-0107 (1.15 GPM)	B-0109-01 (6")	N	—	32-7/8" (835 mm)	Includes B-0970-FEZ vacuum breaker, 10" riser
B-0113-B	Eterna	B-0107 (1.15 GPM)	B-0109-01 (6")	N	—	42-1/16" (1068 mm)	See photo p. A18
B-0113-B-TEE	Eterna	B-0107 (1.15 GPM)	B-0109-01 (6")	N	—	44-1/8" (1121 mm)	B-TEE-RGD accessory fitting tee; See photo p. A18
B-0113-B9	Eterna	B-0107 (1.15 GPM)	B-0109-02 (9")	N	—	42-1/16" (1068 mm)	9" wall bracket
B-0113-BM	Eterna	B-0107 (1.15 GPM)	B-0109-01 (6")	N	—	42-1/16" (1068 mm)	B-0113-B Master Box (6)
B-0113-BR	Eterna	B-0107 (1.15 GPM)	B-0109-01 (6")	N	—	42-1/16" (1068 mm)	B-0044-R PVC hose
B-0113-CR	Cerama	B-0107 (1.15 GPM)	N	N	—	42-1/16" (1068 mm)	
B-0113-CR-B	Cerama	B-0107 (1.15 GPM)	B-0109-01 (6")	N	—	42-1/16" (1068 mm)	
B-0113-CR-V-B	Cerama	B-0107 (1.15 GPM)	B-0109-01 (6")	N	—	41-3/4" (1060 mm)	B-0970-FEZ EasyInstall vacuum breaker
B-0113-M	Eterna	B-0107 (1.15 GPM)	N	N	—	42-1/16" (1068 mm)	B-0113 Master Box (6)
B-0113-SWV	Eterna	B-0107 (1.15 GPM)	N	N	—	42-1/16" (1068 mm)	018200-40 pre-rinse swivel on spray valve for 360° rotation
Add-On Faucet Models:							
B-0113-ADF06	Eterna	B-0107 (1.15 GPM)	N	Y	6" (152 mm)	49-7/16" (1255 mm)	
B-0113-ADF08-B	Eterna	B-0107 (1.15 GPM)	B-0109-01 (6")	Y	8" (203 mm)	49-7/16" (1255 mm)	
B-0113-ADF10-B	Eterna	B-0107 (1.15 GPM)	B-0109-01 (6")	Y	10" (254 mm)	49-7/16" (1255 mm)	
B-0113-ADF12	Eterna	B-0107 (1.15 GPM)	N	Y	12" (305 mm)	49-7/16" (1255 mm)	
B-0113-ADF12-B	Eterna	B-0107 (1.15 GPM)	B-0109-01 (6")	Y	12" (305 mm)	49-7/16" (1255 mm)	See photo p. A18
B-0113-A12B-TEE	Eterna	B-0107 (1.15 GPM)	B-0109-01 (6")	Y	12" (305 mm)	48-3/8" (1229 mm)	B-TEE-RGD accessory tee; see p. A5
B-0113-12-CRBJ	Cerama	B-0107-J (1.07 GPM)	B-0109-01 (6")	Y	12" (305 mm)	46-1/4" (1175 mm)	
B-0113-12-CR-B	Cerama	B-0107 (1.15 GPM)	B-0109-01 (6")	Y	12" (305 mm)	42-1/4" (1073 mm)	
B-0113-12-CRVB	Cerama	B-0107 (1.15 GPM)	B-0109-01 (6")	Y	12" (305 mm)	46" (1168 mm)	B-0970-FEZ vacuum breaker



B-0123 series pre-rinse units with the B-0108 (1.07 GPM) and B-0108-C (0.65 GPM) JeTSpray valves feature:

- Ergonomic B-0108 and B-0108-C JeTSpray valves are powerful and efficient
- All pre-rinse units are equipped with quarter-turn cartridges including cross flow prevention
- Hot Eterna Cartridge – 012443-40NS • Cold Eterna Cartridge – 012442-40NS
- Hot Cerama Cartridge – 012394-25NS • Cold Cerama Cartridge – 012395-25NS

B-0123-08 and B-0123-08C Pre-Rinse Units

- B-0108 JeTSpray Valve (1.07 GPM)
- B-0108-C Low Flow JeTSpray Valve (0.65 GPM)

Easy Install

- 8" (203 mm) deck mount base faucet assembly (B-0220-LN) with EasyInstall™ "pop and lock" riser installation feature
- Overhead spring
- Quarter-turn cartridges with cross flow prevention
- 1/2" NPT female eccentric flanged inlets (00AA)
- B-0044-H2A 44" flexible stainless steel hose
- Finger hook (004R)

Note: Supply nipples sold separately – B-0425 (2 required, see *Accessories* section, p. ACS21).

A
20

JeTSpray



B-0123-B08

B-0123-A12-B08C

B-0123 BASE FAUCET PRU	1/4-Turn CARTRIDGE w/Cross Flow Prevention	SPRAY VALVE / GPM	WALL BRACKET	ADD-ON FAUCET	NOZZLE LENGTH	OVERALL HEIGHT	NOTES
B-0123-08	Eterna	B-0108 (1.07 GPM)	N	N	–	41-3/4" (1061 mm)	
B-0123-08C	Eterna	B-0108-C (0.65 GPM)	N	N	–	41-3/4" (1061 mm)	
B-0123-B08	Eterna	B-0108 (1.07 GPM)	B-0109-01 (6")	N	–	41-3/4" (1061 mm)	See photo above
B-0123-B08C	Eterna	B-0108-C (0.65 GPM)	B-0109-01 (6")	N	–	41-3/4" (1061 mm)	
Add-On Faucet Models:							
B-0123-A06-B08	Eterna	B-0108 (1.07 GPM)	B-0109-01 (6")	Y	6" (152 mm)	46-3/8" (1178 mm)	
B-0123-A06-B08C	Eterna	B-0108-C (0.65 GPM)	B-0109-01 (6")	Y	6" (152 mm)	46-3/8" (1178 mm)	
B-0123-A08-B08	Eterna	B-0108 (1.07 GPM)	B-0109-01 (6")	Y	8" (203 mm)	46-3/8" (1178 mm)	
B-0123-A08-B08C	Eterna	B-0108-C (0.65 GPM)	B-0109-01 (6")	Y	8" (203 mm)	46-3/8" (1178 mm)	
B-0123-A10-B08	Eterna	B-0108 (1.07 GPM)	B-0109-01 (6")	Y	10" (254 mm)	46-3/8" (1178 mm)	
B-0123-A10-B08C	Eterna	B-0108-C (0.65 GPM)	B-0109-01 (6")	Y	10" (254 mm)	46-3/8" (1178 mm)	
B-0123-A12-08	Eterna	B-0108 (1.07 GPM)	N	Y	12" (305 mm)	46-3/8" (1178 mm)	
B-0123-A12-B08	Eterna	B-0108 (1.07 GPM)	B-0109-01 (6")	Y	12" (305 mm)	46-3/8" (1178 mm)	
B-0123-A12-08C	Eterna	B-0108-C (0.65 GPM)	N	Y	12" (305 mm)	46-3/8" (1178 mm)	
B-0123-A12-B08C	Eterna	B-0108-C (0.65 GPM)	B-0109-01 (6")	Y	12" (305 mm)	46-3/8" (1178 mm)	See photo above



B-0123 series pre-rinse units with the B-0107-C (0.65 GPM) and B-0107-J (1.07 GPM) low flow spray valves feature:

- B-0107-C and B-0107-J spray valves are powerful and efficient
- All pre-rinse units are equipped with quarter-turn cartridges including cross flow prevention
- Hot Eterna Cartridge – 012443-40NS • Cold Eterna Cartridge – 012442-40NS
- Hot Cerama Cartridge – 012394-25NS • Cold Cerama Cartridge – 012395-25NS

B-0123-C and B-0123-J Pre-Rinse Units

- B-0107-C Ultimate Low Flow Spray Valve (0.65 GPM)**
- B-0107-J Low Flow Spray Valve (1.07 GPM)**

- 8" (203 mm) deck mount base faucet assembly (B-0220-LN) with EasyInstall™ "pop and lock" riser installation feature
- Overhead spring
- Quarter-turn cartridges with cross flow prevention
- 1/2" NPT female eccentric flanged inlets (00AA)
- B-0044-H 44" flexible stainless steel hose
- Finger hook (004R)

Note: Supply nipples sold separately – B-0425 (2 required, see *Accessories* section, p. ACS21).

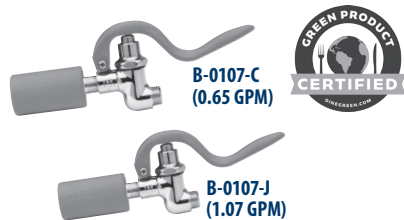

Easy Install



B-0123-BC



B-0123-ADF12-BJ

B-0123 BASE FAUCET PRU	1/4-Turn CARTRIDGE w/Cross Flow Prevention	SPRAY VALVE / GPM	WALL BRACKET	ADD-ON FAUCET	NOZZLE LENGTH	OVERALL HEIGHT	NOTES
B-0123-BC	Eterna	B-0107-C (0.65 GPM)	B-0109-01 (6")	N	–	41-3/4" (1061 mm)	See photo above
B-0123-C	Eterna	B-0107-C (0.65 GPM)	N	N	–	41-3/4" (1061 mm)	
B-0123-CR-BC	Cerama	B-0107-C (0.65 GPM)	B-0109-01 (6")	N	–	41-3/4" (1061 mm)	
B-0123-CR-J	Cerama	B-0107-J (1.07 GPM)	N	N	–	41-3/4" (1061 mm)	
B-0123-J	Eterna	B-0107-J (1.07 GPM)	N	N	–	41-3/4" (1061 mm)	
B-0123-V-BC	Eterna	B-0107-C (0.65 GPM)	B-0109-01 (6")	N	–	46-9/16" (1183 mm)	B-0970-FEZ Vacuum breaker
Add-On Faucet Models:							
B-0123-12-CR-BC	Cerama	B-0107-C (0.65 GPM)	B-0109-01 (6")	Y	12" (305 mm)	46" (1168 mm)	
B-0123-12CRBJST	Cerama	B-0107-J (1.07 GPM)	B-0109-01 (6")	Y	12" (305 mm)	42" (1066 mm)	B-TEE-RGD accessory tee and swivel; see p. A57
B-0123-12CRCVBC	Cerama	B-0107-C (0.65 GPM)	B-0109-01 (6")	Y	12" (305 mm)	45-3/16" (1148 mm)	B-0970-FEZ Vacuum breaker
B-0123-A12-V-BC	Eterna	B-0107-C (0.65 GPM)	B-0109-01 (6")	Y	12" (305 mm)	45-1/8" (1146 mm)	B-0970-FEZ Vacuum breaker
B-0123-ADF12-BJ	Eterna	B-0107-J (1.07 GPM)	B-0109-01 (6")	Y	12" (305 mm)	46" (1168 mm)	See photo above



B-0123 series pre-rinse units with the B-0107 (1.15 GPM) spray valve feature:

- B-0107 spray valve is powerful and efficient
- All pre-rinse units are equipped with quarter-turn cartridges including cross flow prevention
- Hot Eterna Cartridge – 012443-40NS • Cold Eterna Cartridge – 012442-40NS
- Hot Cerama Cartridge – 012394-25NS • Cold Cerama Cartridge – 012395-25NS

B-0123-B Series Pre-Rinse Units

B-0107 Spray Valve

- 8" (203 mm) deck mount base faucet assembly (B-0220-LN) with EasyInstall™ "pop and lock" riser installation feature
- Overhead spring
- Quarter-turn cartridges with cross flow prevention
- 1/2" NPT female eccentric flanged inlets (00AA)
- B-0044-H 44" flexible stainless steel hose
- Finger hook (004R)

Note: Supply nipples sold separately – B-0425 (2 required, see *Accessories* section, p. ACS21).



Easy Install



B-0123-B

B-0123-ADF08-B

B-0123 BASE FAUCET PRU	1/4-Turn CARTRIDGE w/ Cross Flow Prevention	SPRAY VALVE / GPM	WALL BRACKET	ADD-ON FAUCET	NOZZLE LENGTH	OVERALL HEIGHT	NOTES
B-0123	Eterna	B-0107 (1.15 GPM)	N	N	–	41-3/4" (1061 mm)	
B-0123-B	Eterna	B-0107 (1.15 GPM)	B-0109-01 (6")	N	–	41-3/4" (1061 mm)	See photo above
B-0123-B9	Eterna	B-0107 (1.15 GPM)	B-0109-02 (9")	N	–	41-3/4" (1061 mm)	
B-0123-BM	Eterna	B-0107 (1.15 GPM)	B-0109-01 (6")	N	–	41-3/4" (1061 mm)	B-0123-B Master Box (6)
B-0123-CR	Cerama	B-0107 (1.15 GPM)	N	N	–	41-3/4" (1061 mm)	
B-0123-CR-CCV-B	Cerama	B-0107 (1.15 GPM)	B-0109-01 (6")	N	–	41" (1041 mm)	B-0970-FEZ Vacuum Breaker; 00CC 1/2" NPT inlets
B-0123-CR-B	Cerama	B-0107 (1.15 GPM)	B-0109-01 (6")	N	–	41-3/4" (1061 mm)	
B-0123-M	Eterna	B-0107 (1.15 GPM)	N	N	–	41-3/4" (1061 mm)	B-0123 Master Box (6)

Add-On Faucet Models:

B-0123-ADF06-B	Eterna	B-0107 (1.15 GPM)	B-0109-01 (6")	Y	6" (152 mm)	46" (1169 mm)	
B-0123-ADF08	Eterna	B-0107 (1.15 GPM)	N	Y	8" (203 mm)	46" (1169 mm)	
B-0123-ADF08-B	Eterna	B-0107 (1.15 GPM)	B-0109-01 (6")	Y	8" (203 mm)	46" (1169 mm)	See photo above
B-0123-ADF10-B	Eterna	B-0107 (1.15 GPM)	B-0109-01 (6")	Y	10" (254 mm)	46" (1169 mm)	
B-0123-ADF12	Eterna	B-0107 (1.15 GPM)	N	Y	12" (305 mm)	46" (1169 mm)	
B-0123-ADF12-B	Eterna	B-0107 (1.15 GPM)	B-0109-01 (6")	Y	12" (305 mm)	46" (1169 mm)	

Lined writing area consisting of multiple horizontal blue lines.

**B-0133-08 and B-0133-08C
Pre-Rinse Units**

Easy Install

B-0108	JeTSpray Valve (1.07 GPM)
B-0108-C	Low Flow JeTSpray Valve (0.65 GPM)

B-0133 BASE FAUCET PRU	1/4-Turn CARTRIDGE w/ Cross Flow Prevention	SPRAY VALVE / GPM	WALL BRACKET	ADD-ON FAUCET	NOZZLE LENGTH	OVERALL HEIGHT	NOTES
B-0133-08	Eterna	B-0108 (1.07 GPM)	N	N	—	33-5/16" (846 mm)	
B-0133-B08	Eterna	B-0108 (1.07 GPM)	B-0109-01 (6")	N	—	33-5/16" (846 mm)	See photo p. A24
B-0133-B08-SWV	Eterna	B-0108 (1.07 GPM)	B-0109-01 (6")	N	—	33-5/16" (846 mm)	018200-40 pre-rinse swivel on spray valve for 360° rotation
B-0133-CR-B08	Cerama	B-0108 (1.07 GPM)	B-0109-01 (6")	N	—	33-5/16" (846 mm)	
B-0133-CR-B08W4	Cerama	B-0108 (1.07 GPM)	B-0109-01 (6")	N	—	33-5/16" (846 mm)	4" Wrist-action handles
B-0133-CR-B8SWX	Cerama	B-0108 (1.07 GPM)	B-0109-01 (6")	N	—	23-5/16" (592 mm)	018200-40 pre-rinse swivel on spray valve for 360° rotation; club handles; 8" riser; B-0032-H2A 32" hose

**A
25**

Add-On Faucet Models:

B-0133-A06-08	Eterna	B-0108 (1.07 GPM)	N	Y	6" (152 mm)	37-9/16" (954 mm)	
B-0133-A08-08	Eterna	B-0108 (1.07 GPM)	N	Y	8" (203 mm)	37-9/16" (954 mm)	
B-0133-A08-B08	Eterna	B-0108 (1.07 GPM)	B-0109-01 (6")	Y	8" (203 mm)	37-9/16" (954 mm)	
B-0133-A10-B08	Eterna	B-0108 (1.07 GPM)	B-0109-01 (6")	Y	10" (254 mm)	37-9/16" (954 mm)	
B-0133-A12-08	Eterna	B-0108 (1.07 GPM)	N	Y	12" (305 mm)	37-9/16" (954 mm)	
B-0133-A12-B08	Eterna	B-0108 (1.07 GPM)	B-0109-01 (6")	Y	12" (305 mm)	37-9/16" (954 mm)	

**B-0133
BASE FAUCET
PRU**

B-0108-C

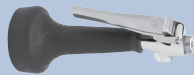

Low-Flow JeTSpray Valve (0.65 GPM)

B-0133-08C	Eterna	B-0108-C (0.65 GPM)	N	N	—	33-5/16" (846 mm)	
B-0133-B08C	Eterna	B-0108-C (0.65 GPM)	B-0109-01 (6")	N	—	33-5/16" (846 mm)	
B-0133-CR-B08C	Cerama	B-0108-C (0.65 GPM)	B-0109-01 (6")	N	—	33-5/16" (846 mm)	
B-0133-EE-CR-8C	Cerama	B-0108-C (0.65 GPM)	N	N	—	33-5/16" (846 mm)	00EE 1/2" NPT Male Inlets w/ adj. flanges

Add-On Faucet Models:

B-0133-01-CR-8C	Cerama	B-0108-C (0.65 GPM)	B-0109-02 (9")	Y	14" (356 mm)	37-9/16" (954 mm)	B-0056-H2A 56" Hose
B-0133-A06-08C	Eterna	B-0108-C (0.65 GPM)	N	Y	6" (152 mm)	37-9/16" (954 mm)	
B-0133-A08-B08C	Eterna	B-0108-C (0.65 GPM)	B-0109-01 (6")	Y	8" (203 mm)	37-9/16" (954 mm)	
B-0133-A10-08C	Eterna	B-0108-C (0.65 GPM)	N	Y	10" (254 mm)	37-9/16" (954 mm)	
B-0133-A10-B08C	Eterna	B-0108-C (0.65 GPM)	B-0109-01 (6")	Y	10" (254 mm)	37-9/16" (954 mm)	
B-0133-A12-08C	Eterna	B-0108-C (0.65 GPM)	N	Y	12" (305 mm)	37-9/16" (954 mm)	
B-0133-A12-B08C	Eterna	B-0108-C (0.65 GPM)	B-0109-01 (6")	Y	12" (305 mm)	37-9/16" (954 mm)	See photo, p. A24
B-0133-A12-B8CX	Eterna	B-0108-C (0.65 GPM)	B-0109-01 (6")	Y	12" (305 mm)	29-9/16" (751 mm)	10" (254 mm) Riser



All B-0133 series pre-rinse units with the B-0107 (1.15 GPM) spray valve feature:

- B-0107 spray valve is powerful and efficient
- All pre-rinse units are equipped with quarter-turn cartridges including cross flow prevention
- Hot Eterna Cartridge – 012443-40NS • Cold Eterna Cartridge – 012442-40NS
- Hot Cerama Cartridge – 012394-25NS • Cold Cerama Cartridge – 012395-25NS

B-0133-B Series Pre-Rinse Units

B-0107 Spray Valve (1.15 GPM)

Easy Install

- 8" (203 mm) wall mount base faucet assembly (B-0230-LN) with EasyInstall™ "pop and lock" riser installation feature
- Quarter-turn cartridges with cross flow prevention
- Overhead spring
- B-0109-01 6" (152 mm) wall bracket
- 1/2" NPT female eccentric flanged inlets (00AA)
- B-0044-H 44" flexible stainless steel hose
- Finger hook (004R)

Note: Installation Kit sold separately – B-0230-K (1 required, see *Parts Kits* section, p. G9, or order a B-0133-B-02).

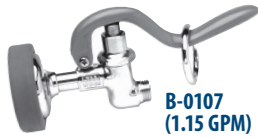

B-0107
(1.15 GPM)



B-0133-B



B-0133-ADF08-B

B-0133 BASE FAUCET PRU	1/4-Turn CARTRIDGE w/Cross Flow Prevention	SPRAY VALVE / GPM	WALL BRACKET	ADD-ON FAUCET	NOZZLE LENGTH	OVERALL HEIGHT	NOTES
B-0133	Eterna	B-0107 (1.15 GPM)	N	N	–	33-5/16" (846 mm)	
B-0133-B	Eterna	B-0107 (1.15 GPM)	B-0109-01 (6")	N	–	33-5/16" (846 mm)	See photo above
B-0133-B-02	Eterna	B-0107 (1.15 GPM)	B-0109-01 (6")	N	–	33-5/16" (846 mm)	B-0230-K Installation Kit
B-0133-B-SWV	Eterna	B-0107 (1.15 GPM)	B-0109-01 (6")	N	–	33-5/16" (846 mm)	018200-40 pre-rinse swivel on spray valve for 360° rotation
B-0133-B-TEE	Eterna	B-0107 (1.15 GPM)	B-0109-01 (6")	N	–	35-9/16" (903 mm)	B-TEE-RGD accessory tee
B-0133-B9	Eterna	B-0107 (1.15 GPM)	B-0109-02 (9")	N	–	33-5/16" (846 mm)	
B-0133-BM	Eterna	B-0107 (1.15 GPM)	B-0109-01 (6")	N	–	33-5/16" (846 mm)	Master Box (6)
B-0133-BQD	Eterna	B-0107 (1.15 GPM)	B-0109-01 (6")	N	–	33-5/16" (846 mm)	Quick-disconnect Hose
B-0133-BR	Eterna	B-0107 (1.15 GPM)	B-0109-01 (6")	N	–	33-5/16" (846 mm)	B-0044-R PVC Hose
B-0133-CC	Eterna	B-0107 (1.15 GPM)	N	N	–	33-5/16" (846 mm)	00CC 1/2" NPT Male Inlets
B-0133-CCB	Eterna	B-0107 (1.15 GPM)	B-0109-01 (6")	N	–	33-5/16" (846 mm)	00CC 1/2" NPT Male Inlets
B-0133-CCB-CR	Cerama	B-0107 (1.15 GPM)	B-0109-01 (6")	N	–	33-5/16" (846 mm)	00CC 1/2" NPT Male Inlets
B-0133-CCB-M	Eterna	B-0107 (1.15 GPM)	B-0109-01 (6")	N	–	33-5/16" (846 mm)	00CC 1/2" NPT Male Inlets; Master Box (6)
B-0133-CR	Cerama	B-0107 (1.15 GPM)	N	N	–	33-5/16" (846 mm)	
B-0133-CR-B	Cerama	B-0107 (1.15 GPM)	B-0109-01 (6")	N	–	33-5/16" (846 mm)	
B-0133-CR-V-BE	Cerama	B-0107 (1.15 GPM)	B-0109-01 (6")	N	–	37" (940 mm)	B-0970-FEZ V.B.; B-0230-K Inst. Kit

B-0133-B Series Pre-Rinse Units

Easy Install

B-0107 Spray Valve (1.15 GPM)



B-0133-B

B-0133-B Series PRE-RINSE UNITS, cont.

B-0133 BASE FAUCET PRU	1/4-Turn CARTRIDGE w/Cross Flow Prevention	SPRAY VALVE / GPM	WALL BRACKET	ADD-ON FAUCET	NOZZLE LENGTH	OVERALL HEIGHT	NOTES
B-0133-EE-B	Eterna	B-0107 (1.15 GPM)	B-0109-01 (6")	N	—	33-5/16" (846 mm)	00EE 1/2" NPT Male Inlets
B-0133-EE-BM	Eterna	B-0107 (1.15 GPM)	B-0109-01 (6")	N	—	33-5/16" (846 mm)	Master Box (6)
B-0133-LB	Eterna	B-0107 (1.15 GPM)	N	N	—	—	Riser, Hose and Spray Valve less Base Faucet
B-0133-M	Eterna	B-0107 (1.15 GPM)	N	N	—	33-5/16" (846 mm)	B-0133 Master Box (6)
B-0133-SWV	Eterna	B-0107 (1.15 GPM)	N	N	—	33-5/16" (846 mm)	018200-40 pre-rinse swivel w/ 360° rotation
B-0133-V-B	Eterna	B-0107 (1.15 GPM)	B-0109-01 (6")	N	—	36-7/8" (937 mm)	B-0970-FEZ V.B.
B-0133-V-B-68H	Eterna	B-0107 (1.15 GPM)	B-0109-01 (6")	N	—	36-7/8" (937 mm)	V.B.; 68" Flexible Stain. Steel Hose
Add-On Faucet Models:							
B-0133-12-CRVBE	Cerama	B-0107 (1.15 GPM)	B-0109-01 (6")	Y	12" (305 mm)	41-1/8" (1044 mm)	Vacuum Breaker and B-0230-K Kit
B-0133-14-CR-B	Cerama	B-0107 (1.15 GPM)	B-0109-01 (6")	Y	14" (356 mm)	37-9/16" (954 mm)	
B-0133-18DJ-CRB	Cerama	B-0107 (1.15 GPM)	B-0109-01 (6")	Y	—	37-5/8" (956 mm)	Double-joint add-on faucet
B-0133-A12B-TEE	Eterna	B-0107 (1.15 GPM)	B-0109-01 (6")	Y	12" (305 mm)	39-5/8" (1006 mm)	B-TEE-RGD accessory tee
B-0133-ADF06	Eterna	B-0107 (1.15 GPM)	N	Y	6" (152 mm)	37-9/16" (954 mm)	
B-0133-ADF06-B	Eterna	B-0107 (1.15 GPM)	B-0109-01 (6")	Y	6" (152 mm)	37-9/16" (954 mm)	
B-0133-ADF08	Eterna	B-0107 (1.15 GPM)	N	Y	8" (203 mm)	37-9/16" (954 mm)	
B-0133-ADF08-B	Eterna	B-0107 (1.15 GPM)	B-0109-01 (6")	Y	8" (203 mm)	37-9/16" (954 mm)	
B-0133-ADF10-B	Eterna	B-0107 (1.15 GPM)	B-0109-01 (6")	Y	10" (254 mm)	37-9/16" (954 mm)	
B-0133-ADF10-BR	Eterna	B-0107 (1.15 GPM)	B-0109-03 (12")	Y	10" (254 mm)	37-9/16" (954 mm)	Brush attachment, Supply Stops, 36" Supply Lines, B-0230-K Kit
B-0133-ADF12	Eterna	B-0107 (1.15 GPM)	N	Y	12" (305 mm)	37-9/16" (954 mm)	
B-0133-ADF12-B	Eterna	B-0107 (1.15 GPM)	B-0109-01 (6")	Y	12" (305 mm)	37-9/16" (954 mm)	
B-0133-ADF12-BM	Eterna	B-0107 (1.15 GPM)	B-0109-01 (6")	Y	12" (305 mm)	37-9/16" (954 mm)	Master Box (6)
B-0133-ADF12-BR	Eterna	B-0107 (1.15 GPM)	B-0109-03 (12")	Y	12" (305 mm)	37-9/16" (954 mm)	Brush attachment, Supply Stops, 36" Supply Lines, B-0230-K Kit
B-0133-A12-CCB	Eterna	B-0107 (1.15 GPM)	B-0109-01 (6")	Y	12" (305 mm)	37-9/16" (954 mm)	00CC 1/2" NPT Male Inlets
B-0133-01	Eterna	B-0107 (1.15 GPM)	B-0109-02 (9")	Y	14" (356 mm)	37-9/16" (954 mm)	B-0056-H Hose, 00CC 1/2" NPT Male Inlets
B-0133-01-36H	Eterna	B-0107 (1.15 GPM)	B-0109-02 (9")	Y	14" (356 mm)	37-9/16" (954 mm)	00CC 1/2" NPT Male Inlets, B-0036-H Hose
B-0133-01-CR	Cerama	B-0107 (1.15 GPM)	N	Y	14" (356 mm)	37-9/16" (954 mm)	B-0056-H Hose
B-0133-A14-CCB	Eterna	B-0107 (1.15 GPM)	B-0109-01 (6")	Y	14" (356 mm)	37-9/16" (954 mm)	00CC 1/2" NPT Male Inlets
B-0133-ADF14-B	Eterna	B-0107 (1.15 GPM)	B-0109-01 (6")	Y	14" (356 mm)	37-9/16" (954 mm)	
B-0133-ADF14-BR	Eterna	B-0107 (1.15 GPM)	B-0109-03 (12")	Y	14" (356 mm)	37-9/16" (954 mm)	Brush attachment, Supply Stops, 36" Supply Lines, B-0230-K Kit
B-0133-A16-CR-B	Cerama	B-0107 (1.15 GPM)	B-0109-01 (6")	Y	16" (406 mm)	37-9/16" (954 mm)	
B-0133-ADF16-B	Eterna	B-0107 (1.15 GPM)	B-0109-01 (6")	Y	16" (406 mm)	37-9/16" (954 mm)	
B-0133-ADF16-BR	Eterna	B-0107 (1.15 GPM)	B-0109-03 (12")	Y	16" (406 mm)	37-9/16" (954 mm)	Brush attachment, Supply Stops, 36" Supply Lines, B-0230-K Kit
B-0133-ADF-LN	Eterna	B-0107 (1.15 GPM)	B-0109-01 (6")	Y	Less nozzle	37-9/16" (954 mm)	Less nozzle



All B-0133 series pre-rinse units with the B-0107-C (0.65 GPM) and B-0107-J (1.07 GPM) low flow spray valves feature:

- B-0107-C and B-0107-J spray valves are powerful and efficient
- All pre-rinse units are equipped with quarter-turn cartridges including cross flow prevention
- Hot Eterna Cartridge – 012443-40NS • Cold Eterna Cartridge – 012442-40NS
- Hot Cerama Cartridge – 012394-25NS • Cold Cerama Cartridge – 012395-25NS

B-0133-C and B-0133-J Pre-Rinse Units

B-0107-C Ultimate Low Flow Spray Valve (0.65 GPM)
B-0107-J Low Flow Spray Valve (1.07 GPM)

Easy Install

**A
28**

- 8" (203 mm) wall mount base faucet assembly (B-0230-LN) with EasyInstall™ "pop and lock" riser installation feature
- Quarter-turn cartridges with cross flow prevention
- Overhead spring
- B-0109-01 6" (152 mm) wall bracket (-B models)
- 1/2" NPT female eccentric flanged inlets (00AA)
- B-0044-H 44" flexible stainless steel hose with handle
- Finger hook (004R)

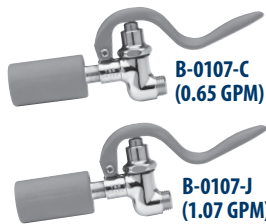

B-0133-BC

B-0133-ADF12-BC

B-0133 BASE FAUCET PRU	1/4-Turn CARTRIDGE w/ Cross Flow Prevention	SPRAY VALVE / GPM	WALL BRACKET	ADD-ON FAUCET	NOZZLE LENGTH	OVERALL HEIGHT	NOTES
B-0133-C	Eterna	B-0107-C (0.65 GPM)	N	N	—	33-5/16" (846 mm)	
B-0133-BC	Eterna	B-0107-C (0.65 GPM)	B-0109-01 (6")	N	—	33-5/16" (846 mm)	See photo, above
B-0133-BJ	Eterna	B-0107-J (1.07 GPM)	B-0109-01 (6")	N	—	33-5/16" (846 mm)	
B-0133-BJ-SWV-T	Eterna	B-0107-J (1.07 GPM)	B-0109-01 (6")	N	—	33-7/16" (849 mm)	018200-40 pre-rinse swivel; B-TEE-RGD accessory tee
B-0133-CR-BC	Cerama	B-0107-C (0.65 GPM)	B-0109-01 (6")	N	—	33-5/16" (846 mm)	
B-0133-CR-BJ-SK	Cerama	B-0107-J (1.07 GPM)	B-0109-01 (6")	N	—	33-5/16" (846 mm)	B-0230-K Inst. Kit
B-0133-CR-C	Cerama	B-0107-C (0.65 GPM)	N	N	—	33-5/16" (846 mm)	
B-0133-CR-J	Cerama	B-0107-J (1.07 GPM)	N	N	—	33-3/8" (848 mm)	
B-0133-CR-V-BCE	Cerama	B-0107-C (0.65 GPM)	B-0109-01 (6")	N	—	36-7/8" (937 mm)	B-0970-FEZ V.B.; B-0230-K Inst. Kit
B-0133-V-BC	Eterna	B-0107-C (0.65 GPM)	B-0109-01 (6")	N	—	36-7/8" (937 mm)	B-0970-FEZ V.B.
Add-On Faucet Models:							
B-0133-ADF12-BC	Eterna	B-0107-C (0.65 GPM)	B-0109-01 (6")	Y	12" (305 mm)	37-9/16" (954 mm)	See photo, above
B-0133-ADF12-BJ	Eterna	B-0107-J (1.07 GPM)	B-0109-01 (6")	Y	12" (305 mm)	37-9/16" (954 mm)	
B-0133-A12-BC4	Eterna	B-0107-C (0.65 GPM)	B-0109-01 (6")	Y	12" (305 mm)	35-3/16" (894 mm)	Four way cross



**B-0133-C and B-0133-J
Pre-Rinse Units**

Easy Install

- B-0107-C Ultimate Low Flow Spray Valve (0.65 GPM)
- B-0107-J Low Flow Spray Valve (1.07 GPM)
- B-0108 JetSpray Valve (1.07 GPM)

B-0133 PRE-RINSE UNITS, cont.

B-0133 BASE FAUCET PRU	1/4-Turn CARTRIDGE w/ Cross Flow Prevention	SPRAY VALVE / GPM	WALL BRACKET	ADD-ON FAUCET	NOZZLE LENGTH	OVERALL HEIGHT	NOTES
Add-On Faucet Models:							
B-0133-10CRBJST	Cerama	B-0107-J (1.07 GPM)	B-0109-01 (6")	Y	10" (254 mm)	39-1/2" (1003 mm)	018200-40 pre-rinse swivel; B-TEE-RGD accessory tee; B-0230-K Inst. Kit
B-0133-12-CRBJ	Cerama	B-0107-J (1.07 GPM)	B-0109-01 (6")	Y	12" (305 mm)	37-9/16" (954 mm)	
B-0133-12ACB8ST	Cerama	B-0107-J (1.07 GPM)	B-0109-01 (6")	Y	12" (305 mm)	39-1/2" (1003 mm)	018200-40 pre-rinse swivel; B-TEE-RGD accessory tee
B-0133-12ACBJST	Cerama	B-0107-J (1.07 GPM)	B-0109-01 (6")	Y	12" (305 mm)	39-1/2" (1003 mm)	018200-40 pre-rinse swivel; B-TEE-RGD accessory tee
B-0133-12ACRB8S	Cerama	B-0108 (1.07 GPM)	B-0109-01 (6")	Y	12" (305 mm)	37-9/16" (954 mm)	018200-40 pre-rinse swivel; VR aerator with add-on faucet (2.2 GPM)
B-0133-12ACRB8T	Cerama	B-0108 (1.07 GPM)	B-0109-01 (6")	Y	12" (305 mm)	39-1/2" (1003 mm)	B-TEE-RGD accessory tee
B-0133-12CRBJK	Cerama	B-0107-J (1.07 GPM)	B-0109-01 (6")	Y	12" (305 mm)	37-9/16" (954 mm)	B-0230-K Inst. Kit
B-0133-12CRBJSK	Cerama	B-0107-J (1.07 GPM)	B-0109-01 (6")	Y	12" (305 mm)	37-9/16" (954 mm)	B-0230-K Inst. Kit; 018200-40 pre-rinse swivel
B-0133-12CRBJST	Cerama	B-0107-J (1.07 GPM)	B-0109-01 (6")	Y	12" (305 mm)	39-1/2" (1003 mm)	B-0230-K Inst. Kit; B-TEE-RGD accessory tee; 018200-40 pre-rinse swivel
B-0133-12CRVBCE	Cerama	B-0107-C (0.65 GPM)	B-0109-01 (6")	Y	12" (305 mm)	41-1/8" (1044 mm)	B-0230-K Inst. Kit; B-0970-FEZ Vac. Brkr.
B-0133-14-CRBJ	Cerama	B-0107-J (1.07 GPM)	B-0109-01 (6")	Y	14" (356 mm)		
B-0133-14CRBJSX	Cerama	B-0107-J (1.07 GPM)	B-0109-01 (6")	Y	14" (356 mm)	37-9/16" (954 mm)	018200-40 pre-rinse swivel; B-TEE-RGD accessory tee; B-0230-K Inst. Kit
B-0133-18CRBJST	Cerama	B-0107-J (1.07 GPM)	B-0109-01 (6")	Y	14" (356 mm)	38-7/16" (976 mm)	018200-40 pre-rinse swivel; B-TEE-RGD accessory tee; B-0230-K Inst. Kit



All B-2200 series pre-rinse units with the B-0107 (1.15 GPM) spray valve feature:

- B-0107 spray valve is powerful and efficient
- All pre-rinse units are equipped with quarter-turn cartridges including cross flow prevention
- Hot Eterna Cartridge – 012443-40NS • Cold Eterna Cartridge – 012442-40NS
- Hot Cerama Cartridge – 012394-25NS • Cold Cerama Cartridge – 012395-25NS

B-2278 Series Pre-Rinse Units

- B-0107 Spray Valve (1.15 GPM)
- B-0107-C Ultimate Low Flow Spray Valve (0.65 GPM)

Easy Install

A
30

- 8" (203 mm) wall mount base faucet assembly (B-0230-LN) with EasyInstall™ "pop and lock" riser installation feature
- Quarter-turn cartridges with cross flow prevention
- Overhead spring
- B-0109-01 6" (152 mm) wall bracket
- Includes supply nipples (B-0425)
- B-0970-FEZ vacuum breaker
- 1/2" NPT female eccentric flanged inlets (00AA)
- B-0044-H 44" flexible stainless steel hose with handle
- Finger hook (004R)

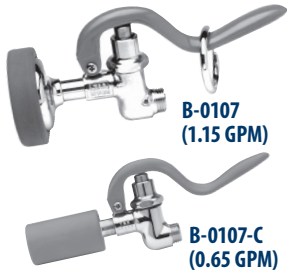

B-2278

B-2278-01

B-0133 BASE FAUCET PRU	1/4-Turn CARTRIDGE w/ Cross Flow Prevention	SPRAY VALVE / GPM	WALL BRACKET	ADD-ON FAUCET	NOZZLE LENGTH	OVERALL HEIGHT	NOTES
B-2278	Eterna	B-0107 (1.15 GPM)	B-0109-01 (6")	N	—	36-7/8 (937 mm)	See photo, above
B-2278-02	Eterna	B-0107-C (0.65 GPM)	B-0109-01 (6")	N	—	36-7/8 (937 mm)	
B-2278-02-CR	Cerama	B-0107-C (0.65 GPM)	B-0109-01 (6")	N	—	36-7/8 (937 mm)	
B-2278-0440-CR	Cerama	B-0107 (1.15 GPM)	B-0109-01 (6")	N	—	36-7/8 (937 mm)	B-0440 extensions
B-2278-B9	Eterna	B-0107 (1.15 GPM)	B-0109-02 (9")	N	—	36-7/8 (937 mm)	
B-2278-CR	Cerama	B-0107 (1.15 GPM)	B-0109-01 (6")	N	—	36-7/8 (937 mm)	
B-2278-CR-C-EL	Cerama	B-0107-C (0.65 GPM)	B-0109-01 (6")	N	—	36-7/8 (937 mm)	Short els with 1/2" NPT female inlets
Add-On Faucet Models:							
B-2278-01	Eterna	B-0107 (1.15 GPM)	B-0109-01 (6")	Y	12" (305 mm)	41-1/8" (1045 mm)	See photo, above
B-2278-01-CR	Cerama	B-0107 (1.15 GPM)	B-0109-01 (6")	Y	12" (305 mm)	41-1/8" (1045 mm)	
B-2278-A12CRCEL	Cerama	B-0107-C (0.65 GPM)	B-0109-01 (6")	Y	12" (305 mm)	41-1/8" (1045 mm)	Short els with 1/2" NPT female inlets
B-2278-ADF	Eterna	B-0107 (1.15 GPM)	B-0109-01 (6")	Y	12" (305 mm)	41-1/8" (1045 mm)	





Pre-rinse units with the B-0107 (1.15 GPM) spray valve

B-0143 Pre-Rinse Unit

- Concealed mixing faucet (B-0512)
- Rigid deck flange (B-0430)
- 1/2" NPSM shank with 150A tailpiece and nut for 1/4" NPT connections
- 38-15/16" (988 mm) high
- 14-1/16" (357 mm) overhang
- 9-5/16" (237 mm) clearance
- 24" (610 mm) riser (000372-40)
- B-0107 spray valve (1.15 GPM)
- B-0044-H 44" flexible stainless steel hose with handle

Note: This pre-rinse unit requires separate check valves. Piping between remote control valve and pre-rinse supplied by others.

B-0143-01 same as B-0143 except less B-0512 remote valve

Check Valves for B-0143

B-CVH3-8 for horizontal or vertical use, 1/2" NPT female
Furnished in rough brass



B-0153 Pre-Rinse Unit

- With double pedal valve (B-0502)
- Rigid deck flange (B-0430)
- 1/2" NPSM shank with 150A tailpiece and nut for 1/4" NPT connections
- 38-15/16" (989 mm) high
- 14-3/4" (374 mm) overhang
- 10-15/16" (277 mm) clearance
- 24" (610 mm) riser (000372-40)
- Spray head (001AS) with adapter (000552-25)
- B-0044-H 44" flexible stainless steel hose

Note: This pre-rinse unit requires separate check valves. Piping between remote control valve and pre-rinse supplied by others.

Check Valves for B-0153

B-CVH1-2 for horizontal or vertical use, 1/2" NPT female

B-CVH3-4 for horizontal or vertical use, 3/4" NPT female
Furnished in rough brass



B-0173 Pre-Rinse Unit

- Single hole base faucet
- Quarter-turn Eterna cartridge with spring check (012443-40NS)
- 18" flexible inlet hoses (compression fittings for 5/8" O.D. tubing or 1/2" NPSM male thread)
- 42-5/16" (1075 mm) high
- 14-1/16" (357 mm) overhang
- 12-13/16" (325 mm) clearance
- 24" (610 mm) riser (000372-40)
- B-0107 spray valve (1.15 GPM)
- B-0044-H 44" flexible stainless steel hose
- Finger hook (004R)
- Mechanical temperature mixing valve with integral check valves

B-0173-B with B-0109-01 6" (152 mm) wall bracket

B-0173-BC with B-0109-01 6" (152 mm) wall bracket and B-0107-C low flow spray valve

B-0173-BR with B-0109-01 6" (152 mm) wall bracket and 44" rubber hose (B-0044-R)



B-0163 Pre-Rinse Unit

- 4" (102 mm) concealed faucet (002837-40)
- 33-3/16" (842 mm) high
- 14-3/16" (361 mm) overhang
- 3-9/16" (91 mm) clearance
- 1/2" NPT female inlets (facing down)
- 18" (457 mm) riser (000369-40)
- B-0107 spray valve (1.15 GPM)
- B-0044-H 44" flexible stainless steel hose

Note: This pre-rinse unit requires separate check valves.

Check Valves for B-0163

B-CVH1-2 for horizontal or vertical use, 1/2" NPT female

B-CVH3-4 for horizontal or vertical use, 3/4" NPT female
Furnished in rough brass





Pre-rinse units with the B-0107 (1.15 GPM) spray valve

B-2187 Pre-Rinse Unit

EasyInstall

- 8" (203 mm) wall mount faucet
- Quarter-turn Eterna cartridges with spring checks
- 37-11/16" (957 mm) high
- 14-1/16" (357 mm) overhang
- 7-1/2" (191 mm) clearance
- 18" (457 mm) riser (00369-40)
- B-0044-R 44" rubber hose
- 1/2" NPT female eccentric flanged inlets (00AA)
- B-0107 spray valve (1.15 GPM)
- B-0109-01 6" (152 mm) wall bracket
- EasyInstall add-on faucet with 14" swing nozzle (B-0158)
- Finger hook (004R)

Note: Installation Kit sold separately – B-0230-K (1 required, see *Parts Kits* section, p. G9).

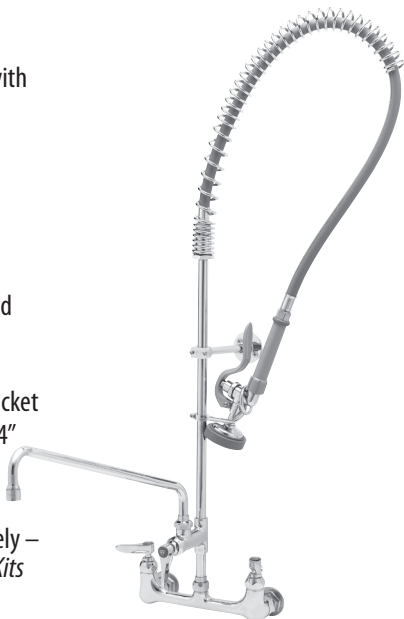

B-2187-01 Pre-Rinse Unit

EasyInstall

- 8" (203 mm) wall mount faucet
- Quarter-turn Eterna cartridges with spring checks
- 37-11/16" (957 mm) high
- 14-1/16" (357 mm) overhang
- 7-1/2" (191 mm) clearance
- 18" (457 mm) riser (00369-40)
- B-0044-H 44" flexible stainless steel hose with handle
- 1/2" NPT female eccentric flanged inlets (00AA)
- B-0107 spray valve (1.15 GPM)
- B-0109-01 6" (152 mm) wall bracket
- EasyInstall add-on faucet with 14" swing nozzle (B-0158)
- Finger hook (004R)

Note: Installation Kit sold separately – B-0230-K (1 required, see *Parts Kits* section, p. G9).



B-2180 Rigid base with 18" (457 mm) add-on faucet, 44" flexible stainless steel hose with handle, B-0109-03 12" (305 mm) wall bracket

B-2194 With 16" (406 mm) add-on faucet, 44" flexible stainless steel hose with handle and B-0109-03 12" (305 mm) wall bracket (right)

B-2194



Note: The two PRU models below are NOT EasyInstall:

B-2223 Pre-Rinse Unit

- 6" (152 mm) deck mount base faucet (008963-40)
- Eterna cartridges with spring checks
- 41-11/16" (1059 mm) high
- 14-1/16" (357 mm) overhang
- 12-3/16" (310 mm) clearance
- 24" (610 mm) riser (000372-40)
- B-0044-H 44" flexible stainless steel hose with handle
- 1/2" NPT female eccentric flanged inlets (00AA)
- B-0107 spray valve (1.15 GPM)
- B-0109-01 6" (152 mm) wall bracket
- Finger hook (004R)

Note: Supply nipples sold separately – B-0425 (2 required, see *Accessories* section, p. ACS21).



B-2261-B Pre-Rinse Unit

- Wall mount base faucet with 00GG inlet arms adjustable from 2-1/2" to 8-1/4" (64 mm to 210 mm) centers
- Quarter-turn Eterna cartridges with spring checks
- 33-7/16" (849 mm) high
- 14-1/16" (357 mm) overhang
- 3-9/16" (91 mm) clearance
- 18" (457 mm) riser (000369-40)
- B-0044-H 44" flexible stainless steel hose with handle
- 1/2" NPT female inlets
- B-0107 spray valve (1.15 GPM)
- B-0109-01 6" (152 mm) wall bracket
- Finger hook (004R)

B-2261 Without B-0109-01 6" (152 mm) wall bracket





Pre-rinse units with the B-0107 (1.15 GPM) Spray Valve feature:

- All pre-rinse units (unless noted) are equipped with quarter-turn cartridges with cross flow prevention
- Hot Eterna Cartridge – 012443-40NS • Cold Eterna Cartridge – 012442-40NS
- Hot Cerama Cartridge – 012394-25NS • Cold Cerama Cartridge – 012395-25NS

B-0111 Pre-Rinse Unit

Easy Install

- Single hole deck mount base faucet with EasyInstall™ “pop and lock” riser installation feature (B-0200-LN)
- 18” flexible inlet hoses (compression fittings for 5/8” O.D. tubing or 1/2” NPSM male thread)
- Quarter-turn Eterna cartridges with spring checks
- 12” (305 mm) overhead swivel arm (002882-40)
- B-0107 spray valve (1.15 GPM)
- B-0020-H 20” flexible stainless steel hose
- Finger hook (004R)

See chart below for additional models:



B-0121 Pre-Rinse Unit

Easy Install

- 8” (203 mm) deck mount faucet (B-0220-LN)
- Quarter-turn Eterna cartridges with spring checks
- 1/2” NPT female eccentric flanged inlets (00AA)
- 38-3/8” (975 mm) high
- 11-5/16” (287 mm) overhang
- 9-3/16” (234 mm) clearance
- 12” (305 mm) overhead swivel arm (002882-40)
- 32” (823 mm) riser (000376-40)
- B-0107 spray valve (1.15 GPM)
- B-0020-H 20” flexible stainless steel hose
- Finger hook (004R)

Note: Supply nipples sold separately – B-0425 (2 required, see Accessories section, p. ACS21).



B-0121-12-CRBJ Same as B-0121 except with B-0107-J spray valve (1.07 GPM), B-0156-EZ add-on faucet, B-0109-01 6” (152 mm) wall bracket and Cerama cartridges with check valves

B-0122 With 18” (457 mm) swivel arm, 38” (969 mm) riser (000377-40), 44-3/8” (1127 mm) high and B-0026-H 26” flexible stainless steel hose (right)

B-0111 SERIES Pre-Rinse Unit	1/4-turn CARTRIDGE w/ Cross Flow Prevention	SPRAY VALVE / GPM	WALL BRACKET	ADD-ON FAUCET	OVERALL HEIGHT	NOTES
B-0111	Eterna	B-0107 (1.15 GPM)	N	N	38-3/4” (984 mm)	
B-0111-B	Eterna	B-0107 (1.15 GPM)	B-0109-01 (6”)	N	38-3/4” (984 mm)	
B-0111-BC	Eterna	B-0107-C (0.65 GPM)	B-0109-01 (6”)	N	38-3/4” (984 mm)	See photo above, left
B-0111-C	Eterna	B-0107-C (0.65 GPM)	N	N	38-3/4” (984 mm)	
B-0111-02	–	B-0107 (1.15 GPM)	B-0109-01 (6”)	N	35” (889 mm)	Less base faucet
B-0112	Eterna	B-0107 (1.15 GPM)	N	N	44-3/8” (1127 mm)	B-0200-LN rigid base faucet; 18” (457 mm) swivel arm; B-0026-H 26” flex. stainless steel hose; 38” (965 mm) riser



Standard B-0107 Spray Valve Pre-Rinse Units with Overhead Swivel Arm



Pre-rinse units with the B-0107 (1.15 GPM) Spray Valve and B-0107-C Ultimate Low-flow Spray Valve (0.65 GPM) feature:

- All pre-rinse units (unless noted) are equipped with quarter-turn cartridges including cross flow prevention
- Hot Eterna Cartridge – 012443-40NS • Cold Eterna Cartridge – 012442-40NS
- Hot Cerama Cartridge – 012394-25NS • Cold Cerama Cartridge – 012395-25NS

B-0131 Pre-Rinse Unit

Easy Install

- 8" (203 mm) wall mount mixing faucet (B-0230-LN)
- Quarter-turn cartridges with cross flow prevention
- 1/2" NPT female eccentric flanged inlets (00AA)
- 12" (305 mm) overhead swivel arm (002882-40)
- B-0107 spray valve (1.15 GPM)
- B-0020-H 20" flexible stainless steel hose
- Finger hook (004R)

Note: Installation Kit sold separately – B-0230-K (1 required, see *Parts Kits* section, p. G9).

**A
36**



B-0131



B-0131-12-CRBJK

B-0131 SERIES Pre-Rinse Unit	1/4-Turn CARTRIDGE w/Cross Flow Prevention	SPRAY VALVE / GPM	WALL BRACKET	ADD-ON FAUCET	NOZZLE LENGTH	OVERALL HEIGHT	NOTES
B-0131	Eterna	B-0107 (1.15 GPM)	N	N	–	30-1/16" (763 mm)	See photo above
B-0131-B	Eterna	B-0107 (1.15 GPM)	B-0109-01 (6")	N	–	30-1/16" (763 mm)	
B-0131-BC	Eterna	B-0107-C (0.65 GPM)	B-0109-01 (6")	N	–	30-1/16" (763 mm)	
B-0131-BC-28H	Eterna	B-0107-C (0.65 GPM)	B-0109-01 (6")	N	–	30-1/16" (763 mm)	B-0028-H hose
B-0131-BC-425	Eterna	B-0107-C (0.65 GPM)	B-0109-01 (6")	N	–	30-1/16" (763 mm)	B-0425 Supply kit
B-0131-C	Eterna	B-0107-C (0.65 GPM)	N	N	–	30-1/16" (763 mm)	
B-0131-CR-B	Cerama	B-0107 (1.15 GPM)	B-0109-01 (6")	N	–	30-1/16" (763 mm)	
B-0131-CR-BC28H	Cerama	B-0107-C (0.65 GPM)	B-0109-01 (6")	N	–	30-1/16" (763 mm)	B-0028-H hose
B-0131-CR-B08C	Cerama	B-0108-C (0.65 GPM)	B-0109-01 (6")	N		29-5/8" (753 mm)	
B-0132	Eterna	B-0107 (1.15 GPM)	N	N	–	35-5/8" (905 mm)	18" (457 mm) swivel arm; 32" (823 mm) riser; B-0026-H 26" hose
Add-On Faucet Models:							
B-0131-ADF12-BC	Eterna	B-0107-C (0.65 GPM)	B-0109-01 (6")	Y	12" (305 mm)	33-13/16" (858 mm)	
B-0131-ADF14-B	Eterna	B-0107 (1.15 GPM)	B-0109-01 (6")	Y	14" (356 mm)	33-7/8" (860 mm)	
B-0131-12-CRBJK	Cerama	B-0107-J (1.07 GPM)	B-0109-01 (6")	Y	12" (305 mm)	34-5/16" (871 mm)	B-0230-K 1/2" NPT Male elbow installation kit; see photo above





Pre-rinse units with the B-0107 Spray Valve and B-0107-C Ultimate Low-flow Spray Valve (0.65 GPM) feature:

- All pre-rinse units (unless noted) are equipped with quarter-turn cartridges including cross flow prevention
- Hot Eterna Cartridge – 012443-40NS • Cold Eterna Cartridge – 012442-40NS
- Hot Cerama Cartridge – 012394-25NS • Cold Cerama Cartridge – 012395-25NS

B-0131-C Pre-Rinse Unit

Easy Install

- 8" (203 mm) wall mount faucet (B-0230-LN)
- Quarter-turn Eterna cartridges with spring checks
- 30-1/16" (763 mm) high
- 11-5/16" (287 mm) overhang
- 1/2" (13 mm) clearance
- 1/2" NPT female eccentric flanged inlets (00AA)
- 12" (305 mm) overhead swivel arm (002882-40)
- 26" (660 mm) riser (000373-40)
- B-0107-C Ultimate low-flow spray valve (0.65 GPM)
- B-0020-H 20" flexible stainless steel hose
- Finger hook (004R)

Note: Installation Kit sold separately – B-0230-K (1 required, see *Parts Kits* section, p. G9).

B-0131-12-CRBJK Same as B-0131-C except with 12" (305 mm) add-on faucet, Cerama cartridges, 6" wall bracket (152 mm), B-0107-J spray valve (1.07 GPM) and B-0230-K Installation Kit

B-0131-ADF12-BC Same as B-0131-C except with 12" (305 mm) add-on faucet and 6" (152 mm) wall bracket

B-0131-ADF14-B Same as B-0131-ADF12-BC except with 14" (356 mm) add-on faucet and B-0107 spray valve

B-0131-B Same as B-0131 except with 6" (152 mm) wall bracket

B-0131-BC Same as B-0131-B except with B-0107-C Ultimate low flow spray valve (0.65 GPM)

B-0141 Pre-Rinse Unit

- Remote control valve (B-0512)
- 35-5/8" (906 mm) high
- 11-5/16" (287 mm) overhang
- 6-1/2" (165 mm) clearance
- Rigid deck flange (B-0430)
- 1/2" NPSM male shank with 150A tailpiece and nut for 1/4" NPT connections
- 12" (305 mm) overhead swivel arm (002882-40)
- 32" (889 mm) riser (000376-40)
- B-0107 spray valve (1.15 GPM)
- B-0020-H 20" flexible stainless steel hose
- Finger hook (004R)

Note: This unit requires separate check valves.

Check Valves for B-0141

B-CVH3-8 for horizontal or vertical use, 3/8" NPT female
Furnished in rough brass



B-0131-C

Pre-Rinse Accessories

See complete line of pre-rinse accessories on pages A51-57



B-0107 Spray Valve
1.15 GPM

B-0107-C Spray Valve
0.65 GPM



B-0107-J Spray Valve
1.07 GPM



B-0107-035 Spray Valve
1.15 GPM



B-0156-EZ Add-On Faucet
with 12" swing nozzle

Various length swing nozzles available; see p. A52.

B-0171 Pre-Rinse Unit

- Single hole deck mount base faucet (B-0205-LN)
- Quarter-turn Eterna cartridge with spring check (012443-40NS)
- 18" flexible inlet hoses (compression fittings for 5/8" O.D. tubing or 1/2" NPSM male thread)
- 39" (991 mm) high
- 11-5/16" (287 mm) overhang
- 9-7/8" (251 mm) clearance
- 12" (305 mm) overhead swivel arm (02882-40)
- 32" (823 mm) riser (000376-40)
- B-0107 spray valve (1.15 GPM)
- B-0020-H 20" flexible stainless steel hose
- Finger hook (004R)
- Mechanical temperature mixing valve with integral check valves

B-0171-01 Same as B-0171 except with B-0119 bi-pod support rods wall bracket and 18" (457 mm) swivel arm



Standard B-0107 Spray Valve Pre-Rinse Units



with Roto-Flex Design

Pre-rinse units with the B-0107 Spray Valve (1.15 GPM) feature:

- All pre-rinse units are equipped with quarter-turn cartridges including cross flow prevention
- Hot Eterna Cartridge – 012443-40NS • Cold Eterna Cartridge – 012442-40NS

B-0114-01B Pre-Rinse Unit

- Single hole deck mount base faucet (B-0200-LN)
- Quarter-turn Eterna cartridges with spring checks
- 18" flexible inlet hoses (compression fittings for 5/8" O.D. tubing or 1/2" NPSM male thread)
- Fits countertops up to 1-1/2" thick
- 42" (1067 mm) high at normal hanging position
- 21-1/2" (646 mm) overhang at maximum pull down position
- 1" (25 mm) clearance in maximum pull down position
- B-0107 spray valve (1.15 GPM)

B-0114-01 Without B-0109-01
6" (152 mm) wall bracket

B-0114-01B-WH4 With wall bracket
and 4" wrist action handles (right)

B-0114-02 35-1/2" (902 mm) high in
normal hanging
position

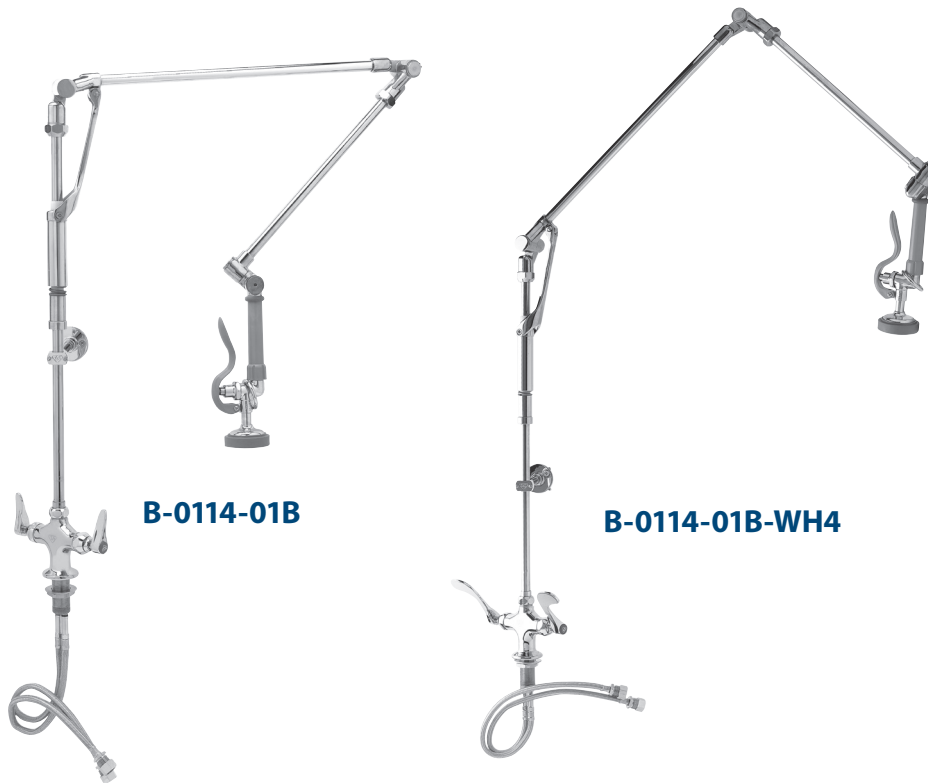

B-0114-01B

B-0114-01B-WH4

B-0124 Pre-Rinse Unit

- 8" (203 mm) deck mount faucet (B-0220-LN)
- Quarter-turn Eterna cartridges with spring checks
- 1/2" NPT female eccentric flanged inlets (00AA)
- 41" (1041 mm) high at normal hanging position
- 21-1/2" (646 mm) overhang at maximum pull down position
- 2-3/4" (70 mm) clearance in maximum pull down position
- B-0107 spray valve (1.15 GPM)

Note: Supply nipples sold separately – B-0425 (2 required, see *Accessories* section, p. ACS21).



B-0134 Pre-Rinse Unit

- 8" (203 mm) wall-mount faucet (B-0230-LN)
- Quarter-turn Eterna cartridges with spring checks
- 1/2" NPT female eccentric flanged inlets (00AA)
- 40" (1016 mm) high at normal hanging position
- 21-1/2" (646 mm) overhang at maximum pull down position
- 1" (25 mm) clearance in maximum pull down position
- B-0107 spray valve (1.15 GPM)

B-0134-B With
B-0109-01 6"
(152 mm) wall
bracket (shown,
right)

Note: Installation Kit sold separately – B-0230-K (1 required, see *Parts Kits* section, p. G9).

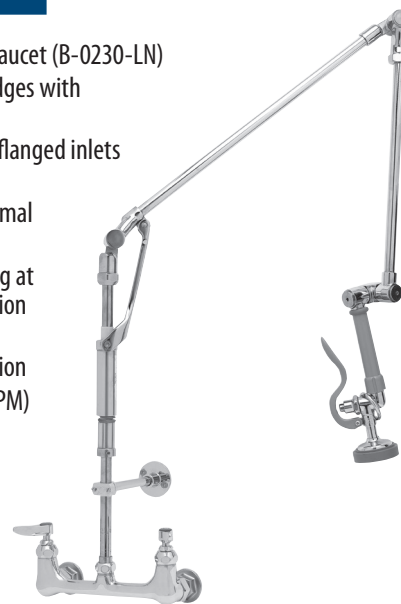



Pre-rinse units with the B-0107-C Ultimate Low Flow Spray Valve (0.65 GPM) feature:

- All pre-rinse units are equipped with cross flow prevention
- Hot Eterna Cartridge – 012443-40NS
- Cold Eterna Cartridge – 012442-40NS

B-0117 Pre-Rinse Unit

- Single hole deck mount base faucet (B-0200-LN)
- Quarter-turn Eterna cartridges with spring checks
- 18" flexible inlet hoses (compression fittings for 5/8" O.D. tubing or 1/2" NPSM male thread)
- 42" (1067 mm) high at normal hanging position
- 21-1/2" (546 mm) overhang at maximum pull down position
- 1/2" (13 mm) clearance in maximum pull down position
- B-0020-H 20" flexible stainless steel hose
- B-0109-01 6" (152 mm) wall bracket
- B-0107-C spray valve (0.65 GPM)



B-0137 Pre-Rinse Unit

- 8" (203 mm) wall mount faucet (B-0230-LN)
- Quarter-turn Eterna cartridges with spring checks
- 39" (990 mm) high at normal hanging position
- 21-1/2" (546 mm) overhang at maximum pull down position
- 6" (152 mm) clearance in maximum pull down position
- 1/2" NPT female eccentric flanged inlets (00AA)
- B-0020-H 20" flexible stainless steel hose
- B-0109-01 6" (152 mm) wall bracket
- B-0107-C spray valve (0.65 GPM)



Note: Installation Kit sold separately – B-0230-K (1 required, see *Parts Kits* section, p. G9).



Pre-rinse units with the B-0107-C and B-0107-C35 Angled Low Flow Spray Valves (0.65 GPM) feature:

- All pre-rinse units are equipped with quarter-turn cartridges including cross flow prevention
- Hot Eterna Cartridge – 012443-40NS • Cold Eterna Cartridge – 012442-40NS
- Hot Cerama Cartridge – 012394-25NS • Cold Cerama Cartridge – 012395-25NS

B-0126 Pre-Rinse Unit

- Pre-rinse unit with balancing assembly (005311-40)
- Single hole deck-mount base faucet (B-0200-LN)
- Quarter-turn Eterna cartridges with spring checks
- 18" flexible inlet hoses (compression fittings for 5/8" O.D. tubing or 1/2" NPSM male thread)
- B-0107-C35 35° angled low flow spray valve (0.65 GPM)
- Long reach – 5 ft. (1524 mm) in either direction
- B-0068-H 68" flexible stainless steel hose
- Hose life substantially increased
- Lever handles with color coded indexes
- Two B-0109-01 6" (152 mm) wall brackets
- 55" (1397 mm) high
- 14" (356 mm) clearance (approximate)

Note: Other hose lengths available as modifications; see *Accessories* section, p. ACS26-27.



B-0126 Series Pre-Rinse Unit	CARTRIDGE w/Cross Flow Prevention	SPRAY VALVE / GPM	WALL BRACKET	ADD-ON FAUCET	NOZZLE LENGTH	OVERALL HEIGHT	NOTES
B-0126	Eterna	B-0107-C35 (0.65 GPM)	(2) B-0109-01 (6")	N	–	55" (1397 mm)	
B-0126-CR	Cerama	B-0107-C35 (0.65 GPM)	(2) B-0109-01 (6")	N	–	55" (1397 mm)	
B-0126-VB	Eterna	B-0107-C35 (0.65 GPM)	(2) B-0109-01 (6")	N	–	55" (1397 mm)	Includes B-0970-FE vacuum breaker for hose
B-0129	Eterna	B-0107-C35 (0.65 GPM)	(2) B-0109-01 (6")	N	–	52-7/8" (1343 mm)	8" wall-mount base faucet; eccentric 00AA inlets
B-0129-VB	Eterna	B-0107-C35 (0.65 GPM)	(2) B-0109-01 (6")	N	–	52-7/8" (1342 mm)	8" wall-mount base faucet; eccentric 00AA inlets; B-0970-FE vacuum breaker for hose
B-0129-VB-08	Eterna	B-0108 (1.07 GPM)	(2) B-0109-01 (6")	N	–	53" (1346 mm)	B-0970-FE vacuum breaker for hose
B-0130	Eterna	B-1420 with quick-disconnect outlet	(2) B-0109-01 (6")	N	–	52-9/16" (1335 mm)	8" wall-mount base faucet; B-0970-FE vacuum breaker for hose; B-1420 quick-disconnect outlet for spray accessories B-1424 and B-1428; DOE 2019 Non-compliant



Low Flow B-0107-C Spray Valve Pre-Rinse Units



with Overhead Swivel with Balancing Unit

Pre-rinse units with the B-0107-C35 Ultimate Low Flow Spray Valve (0.65 GPM) feature:

- All pre-rinse units are equipped with quarter-turn cartridges including cross flow prevention
- Hot Eterna Cartridge – 012443-40NS • Cold Eterna Cartridge – 012442-40NS
- Hot Cerama Cartridge – 012394-25NS • Cold Cerama Cartridge – 012395-25NS

B-0126-R Retrofit for B-0126

- Retrofit kit
- Pre-rinse unit with balancing assembly (005311-40)
- Provides other pre-rinse units with easy upgrade – 3/8" NPT coupling connects to existing riser
- B-0107-C35 angled ultimate low flow spray valve (0.65 GPM)
- 28-5/8" (727 mm) high
- B-0068-H 68" flexible stainless steel hose
- Includes B-0109-01 6" (152 mm) wall bracket

B-0126-VBR With B-0970-FE vacuum breaker hose



B-0140 Pre-Rinse Unit

- 8" (203 mm) wall-mount faucet with Cerama cartridges with check valves and lever handles
- Balancer assembly with B-0970-FE vacuum breaker
- B-0107-C35 angled ultimate low flow spray valve (0.65 GPM)
- B-0068-H 68" flexible stainless steel hose
- B-0156-CR-LN add-on faucet with Cerama cartridge and lever handle and 12" swing nozzle (062X) with B-PT stream regulator
- Two B-0109-01 6" (152 mm) wall brackets
- 18" and 24" risers, 3/8" NPT
- 1/2" NPT female eccentric flanged inlets

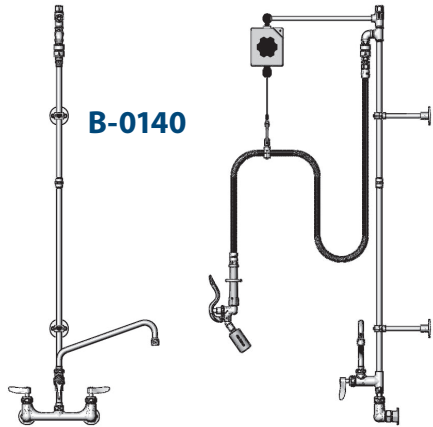

B-0140-01 Pre-Rinse Unit

- 8" (203 mm) wall-mount faucet with Cerama cartridges with check valves and lever handles
- Balancer assembly
- B-0970-FE vacuum breaker
- B-0107-C35 angled ultimate low flow spray valve (0.65 GPM)
- B-0068-H 68" flexible stainless steel hose
- Two B-0109-01 6" (152 mm) wall brackets
- 18" and 24" risers, 3/8" NPT
- 1/2" NPT female eccentric flanged inlets

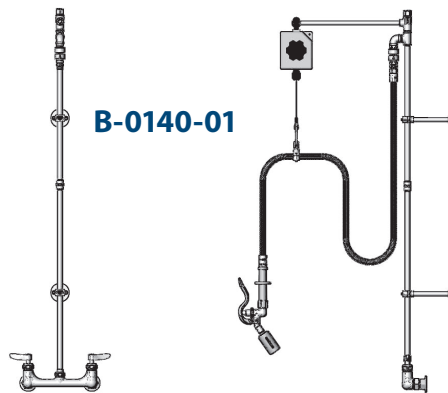

B-0140-08 Pre-Rinse Unit

- 8" (203 mm) wall-mount faucet with Cerama cartridges with check valves and lever handles
- Balancer assembly
- B-0970-FE vacuum breaker
- B-0108 JeTSpray valve (1.07 GPM)
- B-0068-H 68" flexible stainless steel hose with handle
- B-01556-CR-LN add-on faucet with Cerama cartridge and lever handle and 12" swing nozzle (062X) with B-PT stream regulator
- Two B-0109-01 6" (152 mm) wall brackets
- 18" and 24" risers, 3/8" NPT
- 1/2" NPT female eccentric flanged inlets (00AA)

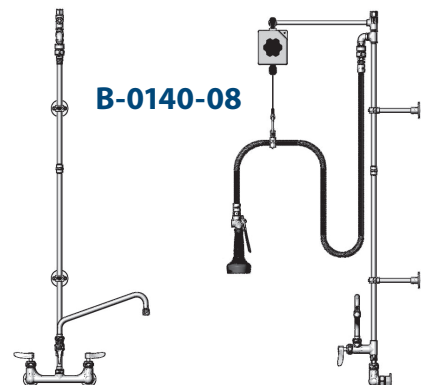

T&S Spray Valve Assemblies

• B-0107 (1.15 GPM)	• B-0107-035 (1.15 GPM)
• B-0107-J (1.07 GPM)	• B-0108 (1.07 GPM)
• B-0107-C (0.65 GPM)	• B-0108-C (0.65 GPM)

New Lower Flow Rate!



B-0100 Spray Valve Assembly

This chart includes all T&S Spray Valve Assemblies on pages A44-45

Spray Valve Assemblies	SPRAY VALVE / OUTLET / GPM	HOSE / LENGTH	HOSE TYPE	OVERALL LENGTH	NOTES
B-0100	B-0107 (1.15 GPM)	B-0044-H 44"	Flex. stainless steel	49-1/8" (1248 mm)	055A 1/2" NPT male adapter
B-0100-08	B-0108 (1.07 GPM)	B-0044-H2A 44"	Flex. stainless steel	47-7/16" (1205 mm)	055A 1/2" NPT male adapter
B-0100-08C	B-0108-C (0.65 GPM)	B-0044-H2A 44"	Flex. stainless steel	47-7/16" (1205 mm)	055A 1/2" NPT male adapter
B-0100-32H	B-0107 (1.15 GPM)	B-0032-H 32"	Flex. stainless steel	37-1/8" (943 mm)	055A 1/2" NPT male adapter
B-0100-60H	B-0107 (1.15 GPM)	B-0060-H 60"	Flex. stainless steel	65-1/8" (1654 mm)	055A 1/2" NPT male adapter
B-0100-C	B-0107-C (0.65 GPM)	B-0044-H 44"	Flex. stainless steel	50-1/16" (1272 mm)	055A 1/2" NPT male adapter
B-0100-C-SWV	B-0107-C (0.65 GPM)	B-0044-H-SWV 44"	Flex. stainless steel	51" (1295 mm)	018200-40 pre-rinse swivel for 360° rotation; 055A 1/2" NPT male adapter
B-0100-CM	B-0107-C (0.65 GPM)	B-0044-H 44"	Flex. stainless steel	50-1/16" (1272 mm)	Master Box (6)
B-0100-J-SWV	B-0107-J (1.07 GPM)	B-0044-H-SWV 44"	Flex. stainless steel	51" (1295 mm)	018200-40 pre-rinse swivel for 360° rotation; 055A 1/2" NPT male adapter
B-0100-M	B-0107 (1.15 GPM)	B-0044-H 44"	Flex. stainless steel	49-1/8" (1248 mm)	Master carton of 6
B-0100-SWV	B-0107 (1.15 GPM)	B-0044-H-SWV 44"	Flex. stainless steel	50-1/16" (1272 mm)	018200-40 pre-rinse swivel for 360° rotation; 055A 1/2" NPT male adapter
B-0101	002857-40 angle spray valve with rosespray outlet	013E-36H 36"	Flex. stainless steel	41-1/16" (1043 mm)	Push button auto shut-off spray valve; for use with B-KF deck flange; DOE 2019 Non-Compliant
B-0101-A	002858-40 angle spray valve with B-0199-02 aerator (2.2 GPM)	013E-36H 36"	Flex. stainless steel	40-3/4" (1035 mm)	For use with B-KF deck flange; DOE 2019 Non-Compliant; 055A 1/2" NPT male adapter
B-0101-A60	002858-40 angle spray valve with B-0199-02 aerator (2.2 GPM)	013E-60H 60"	Flex. stainless steel	64-3/4" (1645 mm)	For use with B-KF deck flange; DOE 2019 Non-Compliant; 055A 1/2" NPT male adapter
B-0101-A68	002858-40 angle spray valve with B-0199-02 aerator (2.2 GPM)	013E-60H 68"	Flex. stainless steel	72-3/4" (1848 mm)	For use with B-KF deck flange; DOE 2019 Non-Compliant; 055A 1/2" NPT male adapter
B-0101-60H	002857-40 angle spray valve with rosespray outlet	013E-60H 60"	Flex. stainless steel	65-3/16" (1656 mm)	DOE 2019 Non-Compliant; 055A 1/2" NPT male adapter
B-0101-E72-053A	002857-40 angle spray valve with rosespray outlet	013E-72H 72"	Flex. stainless steel	77-3/16" (1961 mm)	053A adapter, 3/8" NPT x 3/4-14 UNS; DOE 2019 Non-Compliant
B-0106	005963-40 angle spray valve with brush attachment (1.15 GPM)	B-0044-H 44"	Flex. stainless steel	49-1/8" (1248 mm)	Spray valve with BR-10 brush attachment; 055A 1/2" NPT male adapter
B-0950	B-0107-035 angle spray valve (1.15 GPM)	B-0044-H 44"	Flex. stainless steel	49-1/8" (1248 mm)	055A 1/2" NPT male adapter
B-0950-01	B-0107-035 angle spray valve (1.15 GPM)	B-0068-H 68"	Flex. stainless steel	73-1/8" (1857 mm)	055A 1/2" NPT male adapter
B-0950-54H	B-0107-035 angle spray valve (1.15 GPM)	B-0054-H 54"	Flex. stainless steel	59-1/8" (1502 mm)	055A 1/2" NPT male adapter
B-0955	B-0107 (1.15 GPM)	B-0044-R 44"	Reinforced Rubber	48-1/2" (1232 mm)	Rubber hose with internal braid
B-0956	B-0107-035 angle spray valve (1.15 GPM)	B-0044-R 44"	Reinforced Rubber	48" (1219 mm)	Rubber hose with internal braid
B-0957	B-0107 (1.15 GPM)	B-0044-V 44"	Clear Vinyl	48-1/2" (1232 mm)	Clear vinyl hose with internal braid

Spray Valve Assemblies with the B-0107 (1.15 GPM), B-0107-C (0.65 GPM), B-0107-035 (1.15 GPM), B-0107-J (1.07 GPM), B-0108 (1.07 GPM) and B-0108-C (0.65 GPM) Spray Valves

B-0100-SWV Pre-Rinse Spray Valve Assembly with Swivel



**A
44**

- Includes a swivel (018200-40) at base of handle for 360° rotation capability
- B-0044-H-SWV 44" flexible stainless steel hose
- Designed for heavy-duty use in industrial kitchens
- B-0107 (0.65 GPM) with automatic shut-off valve with spray head
- Hold-down ring for continuous spray
- 1/2" NPT male adapter (055A)
- 49-15/16" (1269 mm) overall length of unit

Note: See page A56 for more information about the Swivel (018200-40)

B-0100-C Low Flow Pre-Rinse Spray Unit



- Designed for heavy-duty use in industrial kitchens
- Conserves water and saves energy
- B-0107-C (0.65 GPM) Ultimate low flow spray valve with automatic shut-off
- Hold-down ring for continuous spray
- Fan jet with knife action spray
- B-0044-H 44" flexible stainless steel hose
- 1/2" NPT male adapter (055A)
- 50-1/16" (1272 mm) overall length of unit



B-0100-CM Ultimate low flow pre-rinse spray Master Box (6)

B-0100-C-SWV Low Flow Pre-Rinse Spray Unit with Swivel



- Includes a swivel (018200-40) at base of handle for 360° rotation capability
- Designed for heavy-duty use in industrial kitchens
- Conserves water and saves energy
- B-0107-C (0.65 GPM) Ultimate low flow spray valve with automatic shut-off
- Hold-down ring for continuous spray
- Fan jet with knife action spray
- B-0044-H-SWV 44" flexible stainless steel hose
- 1/2" NPT male adapter (055A)
- 51" (1295 mm) overall length of unit



Note: See page A56 for more information about the Swivel (018200-40)

B-0100-08 JeTSpray Pre-Rinse Spray Unit



JeTSpray

- Designed for heavy-duty use in industrial kitchens
- Conserves water and saves energy
- B-0108 (1.07 GPM) low flow JeTSpray valve
- Forged brass valve body
- Fast action stainless steel trigger with lock for continuous water flow
- Ergonomic design reduces fatigue caused by repetitive tasks
- Retrofits most pre-rinse hoses
- B-0044-H2A 44" flexible stainless steel hose
- 1/2" NPT male adapter (055A)
- 47-7/16" (1205 mm) overall length

B-0100-08C Same as B-0100-08 except with **B-0108-C** low flow JeTSpray valve (0.65 GPM)

T&S Spray Valve Assemblies

• B-0107 (1.15 GPM)	• B-0107-035 (1.15 GPM)
• B-0107-J (1.07 GPM)	• B-0108 (1.07 GPM)
• B-0107-C (0.65 GPM)	• B-0108-C (0.65 GPM)

New Lower Flow Rate!

B-0100-J-SWV Low Flow Pre-Rinse Spray Unit with Swivel

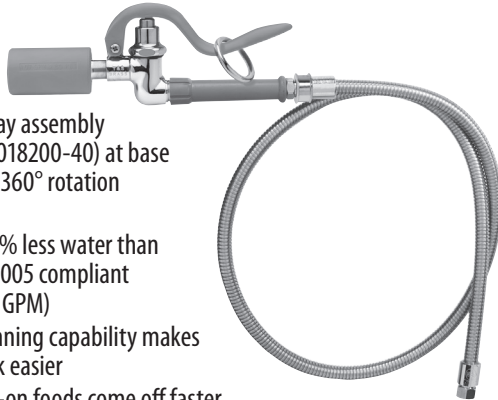

- Pre-rinse spray assembly with swivel (018200-40) at base of handle for 360° rotation capability
- Consumes 33% less water than other EPA Act 2005 compliant valves (at 1.6 GPM)
- Powerful cleaning capability makes pre-rinse task easier
- Tough baked-on foods come off faster
- Designed for heavy-duty use in industrial kitchens
- B-0107-J (1.07 GPM) low flow spray valve with automatic shut-off
- Hold-down ring for continuous water flow
- B-0044-H-SWV 44" flexible stainless steel hose with swivel
- 1/2" NPT male adapter (055A)
- 51" (1295 mm) overall length

B-0101 Spray with Flexible Stainless Steel Hose



- Spray valve assembly with rosespray outlet and push button automatic shut-off (002857-40)
- 013E-36H 36" flexible stainless steel hose
- 1/2" NPT male adapter (055A)
- See "Adapter Chart" p. A48 for alternate adapters
- 41-1/16" (1073 mm) overall length

B-0101-60H Same as B-0101 except with 013E-60H 60" stainless steel hose

B-0101-A Spray with Flexible Stainless Steel Hose

- Spray valve assembly with 2.2 GPM aerator outlet and push button automatic shut-off (002858-40)
- 013E-36H 36" flexible stainless steel hose
- 1/2" NPT male adapter (055A)
- See "Adapter Chart" p. A48 for alternate adapters
- 40-3/4" (1041 mm) overall length



B-0101-A60 Same as B-0101-A except with 013E-60H 60" stainless steel hose
B-0101-A68 Same as B-0101-A except with 013E-68H 68" stainless steel hose
B-0101-A84 Same as B-0101-A except with 013E-84H 84" stainless steel hose

B-0106 Pre-Rinse Brush Spray Unit



- Simultaneous brush and spray action
- Angle spray valve (005963-40) with automatic shut-off (1.15 GPM)
- Hold-down ring for continuous water flow
- Brush attachment with nylon bristles (BR-10)
- B-0044-H 44" flexible stainless steel hose
- 1/2" NPT male adapter (055A)
- 49-1/8" (1248 mm) overall length of unit

B-0950 Flexible Stainless Steel Hose with Self Closing Spray Valve



- B-0107-035 (1.15 GPM) 35° angle spray valve with automatic shut-off
- Hold-down ring for continuous water flow
- B-0044-H 44" flexible stainless steel hose
- 1/2" NPT male adapter (055A)
- Overall length 49-1/8" (1248 mm) of unit

B-0950-01 Same as B-0950 but with B-0068-H 68" stainless steel hose
B-0950-54H Same as B-0950 but with B-0054-H 54" stainless steel hose
B-0956 Same as B-0950 but with B-0044-R 44" reinforced rubber hose

T&S Spray Valve Assemblies

• B-0107 (1.15 GPM)	• B-0107-035 (1.15 GPM)	<i>New Lower Flow Rate!</i>
• B-0107-J (1.07 GPM)	• B-0108 (1.07 GPM)	
• B-0107-C (0.65 GPM)	• B-0108-C (0.65 GPM)	

B-0105 Spray Assembly and Faucet

- Concealed mixing valve (B-0512) with 3/8" NPT inlets and 3" (76 mm) centers
- Four arm faucet handles (175F) with color coded indexes
- B-0044-H 44" flexible stainless steel hose with handle
- B-0107 (1.15 GPM) spray valve
- Wall hook outlet (B-0104) with 3/8" NPT female inlet



Note: This unit requires separate check valves.

Check Valves for B-0105

Furnished in rough brass

B-CVH3-8 for horizontal or vertical use, 3/8" NPT female

B-0160 Deck Mount Base Faucet

- Single hole deck mount base faucet (014207-40)
- 18" (457 mm) flexible inlets with 5/8" compression /1/2" NPSM male couplings
- Quarter-turn Eterna cartridges with spring checks
- 90° swivel adapter (034A)
- B-0107-035 (1.15 GPM) angle spray valve with automatic shut-off
- Dummy wall hook (B-0104-D) holds hose when not in use

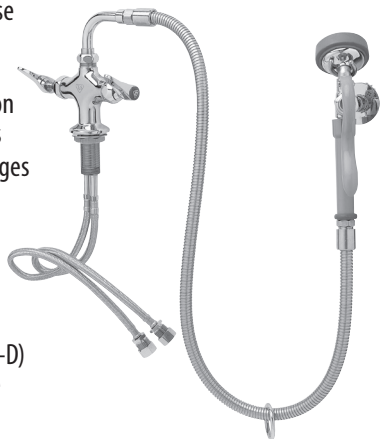

B-0165 Utility Hose and Spray Assembly

- For use with pre-rinse units
- Diverter valve (B-0155-LN)
- B-0104-H 104" flexible stainless steel hose
- 90° swivel adapter (034A)
- B-0107-035 (1.15 GPM) angle spray valve with automatic shut-off
- Hanger hook to hang hose and spray valve out of the way (B-0166)
- 3/8" NPT male fits standard pre-rinse base faucets
- 9' overall length of hose and spray unit



B-0165-C35-68H Washdown Hose Unit for Pre-Rinse Units

- Includes add-on faucet with quarter-turn cartridge and four-arm handle
- Add-on faucet controls flow to washdown hose; not a full shut-off
- B-0068-H 68" stainless steel hose connects to 90° swivel adapter (034A)
- B-0107-C35 (0.65 GPM) angle low-flow spray valve
- B-0166 hanger hook with chrome plated screws
- 3/8" NPT male inlet fits standard T&S rigid base faucets

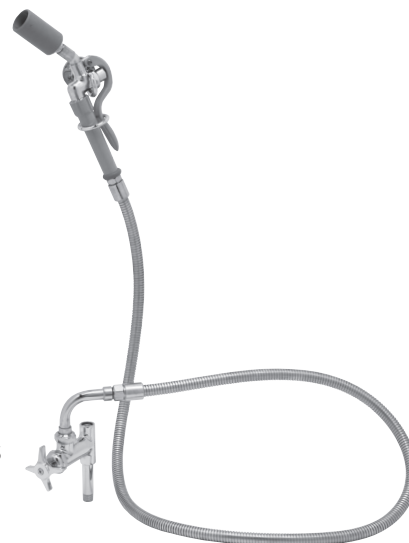

B-0167-HH Wall Mount Base Faucet

- 8" (203 mm) wall mount mixing faucet (002832-40)
- Quarter-turn Eterna cartridges with spring checks and lever handles with color coded indexes
- B-0044-H 44" flexible stainless steel hose
- 90° swivel adapter (034A)
- B-0107-035 (1.15 GPM) angle spray valve
- B-0970-01 vacuum breaker
- B-0104-D wall hook supplied with two screws
- 1/2" NPT female eccentric flanged inlets (00AA)

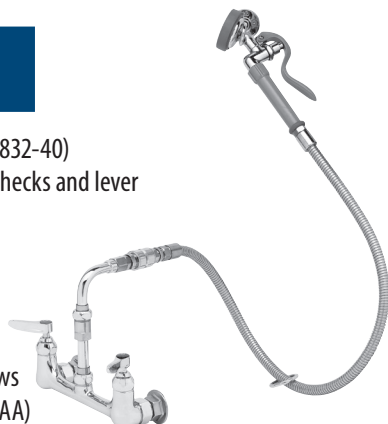

B-0167 Spray Unit with Mixing Control Valve

- 8" wall mount mixing faucet (B-0230-LN)
- EB-0068-H 68" flexible stainless steel hose with blue handle
- EB-0107-035 angle spray valve with automatic shut-off
- Lever handles with color coded indexes
- Finger hook holds hose when not in use (004R)
- Quarter-turn Eterna cartridges with spring checks to prevent cross flow of water
- 72" (1829 mm) overall length of hose and spray unit
- Atmospheric vacuum breaker (B-0968)
- 1/2" NPT female eccentric flanged inlets (00AA)

Note: Installation Kit sold separately; order B-0230-K (see *Parts Kits* section, p. G9).

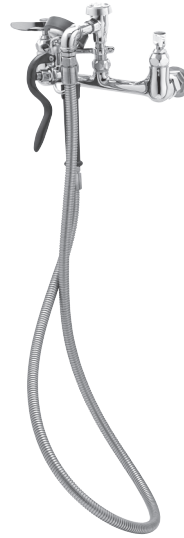

This is a DOE 2019 Non-Compliant spray valve

MODEL	SPRAY VALVE / GPM	HOSE / LENGTH	BASE FAUCET	NOTES
B-0167	EB-0107-035	EB-0068-H 68"	8" wall-mount with Vacuum Breaker	B-0968 atmospheric vacuum breaker; DOE 2019 Non-Compliant
B-0167-01	B-0107-035 (1.15 GPM)	B-0054-H 54"	8" wall-mount with 90° swivel adapter (034A)	B-0970-01 in-line vacuum breaker; DOE 2019 Non-Compliant
B-0168	Angle spray head w/out self-closing valve (005969-40)	B-0068-H 68"	8" C/C Wall-mount with Vacuum Breaker	DOE Compliant

B-0169 Wall Mount Base Faucet

- Single hole, single temperature wall mount faucet and vacuum breaker (B-0968)
- Eterna cartridge with four-arm handle and blue color coded index
- B-0068-H 68" flexible stainless steel hose
- B-0107-035 (1.15 GPM) 35° angle spray valve with automatic shut-off
- Finger hook holds hose when not in use (004R)
- 1/2" NPT female inlet

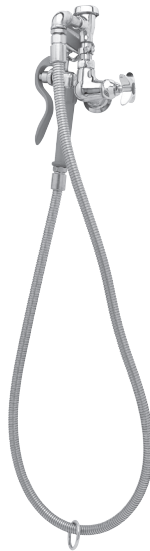

MODEL	SPRAY VALVE / GPM	HOSE / LENGTH	VACUUM BREAKER	NOTES
B-0169	B-0107-035 (1.15 GPM)	B-0068-H 68"	B-0968 3/8" NPT	Finger hook (004R)
B-0169-01	B-0107-035 (1.15 GPM)	B-0096-H 96"	B-0970-FE Inline	B-0166 wall hook
B-0169-102C-96H	(009937-40) 90° spray nozzle with 2.2 GPM aerator	B-0096-H 96"	B-0970-FE Inline	B-0166 wall hook; see illus. above
B-0170	35° Angle 1.15 GPM spray head w/out self-closing valve (005969-40)	B-0068-H 68"	B-0968 3/8" NPT	Finger hook (004R); DOE 2019 Compliant; see photo above

Faucets and Spray Valve Assemblies using the redesigned B-0107-035 Spray Valve (1.15 GPM)

B-0175 Faucet with Swing Nozzle and Spray Unit

- 8" (203 mm) wall mount mixing faucet (B-0230-LN)
- Add-on faucet with 12" (305 mm) swing nozzle (062X) and stream regulator outlet
- Quarter-turn Eterna cartridges with spring checks and lever handles with color coded indexes
- B-0104-H 104" flexible stainless steel hose
- B-0107-035 (1.15 GPM) 35° angle spray valve with automatic shut-off
- 90° swivel adapter (034A)
- Hanger hook holds hose when not in use (B-0166)
- 108" (2743 mm) overall length of hose and spray unit
- 1/2" NPT female eccentric flanged inlets (00AA)

Note: Use a B-0970-01 when a vacuum breaker is needed.

Installation Kit sold separately; order B-0230-K (1 required; see *Parts Kits* section, p. G9).

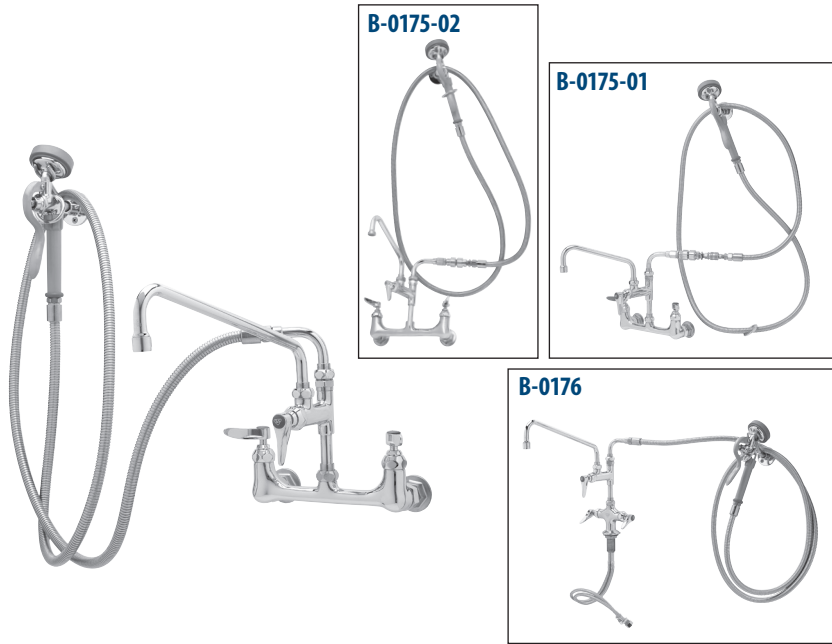

A
48

MODEL	SPRAY VALVE / GPM	HOSE / LENGTH	ADD-ON FAUCET	VACUUM BREAKER	NOTES
B-0175	B-0107-035 (1.15 GPM)	B-0104-H 104"	B-0155-LN w/ 12" swing nozzle (062X) w/ stream regulator	N	See photo, above
B-0175-01	B-0107-035 (1.15 GPM)	B-0096-H 96"	B-0155-LN w/ 8" swing nozzle (060X), stream regulator	B-0970-01	Quick-disconnect on hose; see photo, above
B-0175-02	B-0107-035 (1.15 GPM)	B-0096-H 96"	B-0155-LN w/ 8" swing nozzle (060X), stream regulator	B-0970-01	See photo, above
B-0175-03	B-0107-035 (1.15 GPM)	B-0104-H 104"	B-0155-LN w/ 12" swing nozzle (062X), stream regulator	B-0970-01	
B-0175-CR	B-0107-035 (1.15 GPM)	B-0104-H 104"	B-0155-CR-LN w/ 12" swing nozzle (062X), stream regulator	N	Cerama cartridges on base faucet and add-on faucet
B-0175-CRBJ-CGS	B-0107-J (1.07 GPM)	B-0044-H 44"	B-0155-CR-LN w/ 12" swing nozzle (062X), stream regulator	N	Cerama cartridges on base faucet and add-on faucet; spray valve w/swivel
B-0176	B-0107-035 (1.15 GPM)	B-0104-H 104"	B-0155-LN w/ 12" swing nozzle, B-0199-01 aerator (2.2 GPM)	N	Single hole deck-mount mixing faucet w/ 18" flex. inlets w/ 5/8" compression / 1/2" NPSM male couplings; see photo, above
B-0176-ER	B-0107 (1.15 GPM)	B-0060-H 60"	B-0155-LN w/ 18" swing nozzle (065X), stream regulator	B-0970-01	Single hole deck-mount mixing faucet w/ 18" flex. inlets w/ 5/8" compression / 1/2" NPSM male couplings; optional 10" riser

Adapter Chart

When specified, these adapters will be provided in place of the 1/2" NPT male adapter normally furnished.

052A 1/4" NPT female	057A 3/4" NPT male
053A 3/8" NPT male (Chicago)	058A 3/4" NPT female
054A 3/8" NPT female	059A Garden Hose female
055A 1/2" NPT male	172A 1/4" NPT male (Fisher)
056A 1/2" NPT female	098A Connect two hoses – includes 2 washers (010476-45)

Spray Valve Assemblies using the redesigned B-0107 Spray Valve (1.15 GPM)

B-0177 Faucet with Swing Nozzle and Spray Unit

- 8" (203 mm) deck mount mixing faucet (B-0220-LN)
- Add-on faucet with 12" (305 mm) swing nozzle (B-0156)
- B-0080-H 80" flexible stainless steel hose
- Angled 1.15 GPM spray head attached at end of the hose (005969-40)
- Vacuum breaker (B-0968)
- Manual on-off control to spray head
- B-0104-D wall hook holds hose when not in use
- 1/2" NPT female eccentric flanged inlets (00AA)

Note: Order B-0425 Installation Kit when necessary; (2 required, see *Accessories* section, p. ACS21).



B-1410 Flexible Stainless Steel Hose and Quick-Connect Spray Head



- Quick-connect squeeze valve (1.15 GPM) with automatic shut-off (B-1420)
- Quick-connect spray head (B-1421)
- 3" (75 mm) spray pattern at 30" (762 mm) from spray head
- B-0044-H 44" flexible stainless steel hose
- 1/2" NPT male inlet (055A)
- 49-3/4" (1264 mm) overall length of unit

B-1411 Flexible Stainless Steel Hose and Quick-Connect Jet Head



DOE 2019 Non-Compliant

- Quick-connect squeeze valve with DOE 2019 Non-Compliant automatic shut-off (B-1420)
- 1" (25 mm) diameter spray pattern at 30" (762 mm) from squeeze valve
- Quick-connect jet head (B-1422)
- B-0044-H 44" flexible stainless steel hose
- 1/2" NPT male inlet (see "*Adapter Chart*" on p. A48 for alternate adapters)
- 48" (1219 mm) overall length of unit

B-0178 Faucet with Swing Nozzle and Spray Unit

- 8" (203 mm) deck mount mixing faucet (B-0220-LN)
- Add-on faucet with 12" (305 mm) swing nozzle (B-0156)
- B-0020-H 20" flexible stainless steel hose
- B-0107 spray valve
- 1/2" NPT female eccentric flanged inlets (00AA)

Note: Order B-0425 Installation Kit when necessary; (2 required, see *Accessories* section, p. ACS21).



B-0184 Same as B-0178 except 8" wall-mount faucet with Quarter-turn Cerama cartridges (right)

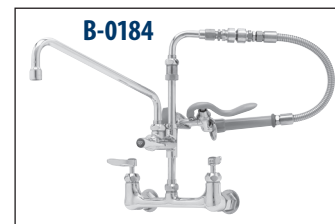

B-1412 Flexible Stainless Steel Hose and Quick-Connect Spray Head



- Quick-connect squeeze valve with automatic shut-off (B-1420)
- Quick-connect fan spray head (B-1423)
- B-0044-H 44" flexible stainless steel hose
- Fan spray pattern 8" (203 mm) wide by 3" (76 mm) thick at 30" (762 mm) from squeeze valve
- 1/2" NPT male inlet (see "*Adapter Chart*" on p. A48 for alternate adapters)
- 48" (1219 mm) overall length of unit

B-1420 Squeeze Valve with Quick-Connect Socket

- Automatic shut-off valve
- Accepts B-1421, B-1422, B-1423, B-1424, B-1425, B-1426, B-1427 and B-1428 outlets
- Valve attaches to flexible stainless steel hoses, PVC hoses and hose reels with handles
- (012504-40) Blue grip handle with 3/8" NPT female inlet connects to hose reels
- (002881-40) Gray grip handle with 3/8" NPT female inlet connects to hose reels



A
50

B-1421 Quick-Connect Spray Head

- Quick-connect spray head (1.15 GPM)
- 3" (76 mm) spray pattern at 30" (762 mm) from spray head
- Spray pattern same as B-0107



B-1423 Fan Spray Quick-Connect

- 8" (203 mm) wide spray pattern by 3" (76 mm) thick at 30" (762 mm) from squeeze valve



B-1425 Nozzle Quick-Connect

- Plain nozzle outlet



B-1427 Rosespray Quick-Connect



B-1422 Jet Quick-Connect

- 1" (25 mm) diameter jet pattern at 30" (762 mm) from squeeze valve



B-1424 Hook Nozzle Quick-Connect

- For filling pots and kettles



B-1426 Aerator Quick-Connect

- 2.2 GPM aerator outlet (B-0199-01)



B-1428 Fan Jet Spray Quick-Disconnect

- Fan jet spray head (0.65 GPM)
- DOE Compliant
- Spray pattern same as B-0107-C



Quick-Disconnect Coupling Set

B-0452 Quick-Disconnect Coupling Set

- Stainless steel
- 1/4" NPT male plug and 3/8" NPT male socket
- When 1/4" NPT plug is removed from quick-disconnect socket, flow is automatically shut off





JeTSpray
B-0108 Series
Ergonomic Spray Valves

Is it possible to “reinvent” something as utilitarian as a spray valve? **T&S has – our revolutionary ergonomic B-0108 JeTSpray, now with 1.07 GPM, another spray valve innovation by T&S Brass for the foodservice market.**

The **JeTSpray** is a breakthrough answer to pre-rinse tasks in the busy kitchen, and is packed with features that you’ll love. It’s built for comfort, with a natural contour and sure grip which fits the human hand. The **JeTSpray’s** ergonomic design helps reduce fatigue with repetitive tasks like rinsing dishes.



Its fast rinsing power and **DOE compliance** combine to give you power **and** efficiency.

The **JeTSpray** has been laboratory tested to over 2 million cycles, demonstrating its heavy-duty capabilities. Its “smart” one-handed lock and unlock feature saves time and makes the user more productive.

Best of all, the **JeTSpray** has the same reliability built into it that all other **T&S Brass** products have. Another innovation for the foodservice plumbing industry – from **T&S Brass**.

**A
51**

- Ergonomic design
- Fast action stainless steel trigger
- Quick change replacement parts
- Smart one-handed trigger lock
- Forged brass body
- Vandal resistant valve cap
- Enhanced maneuverability

- Impact and crush resistant grip
- Heat insulated touch points
- Retrofits most commercial pre-rinse units
- Quick change replacement parts
- Tested at 2 million cycles plus
- Fastest rinsing power in its class
- Removable screen filter

B-0108 Models	
B-0108	1.07 GPM <i>New flow rate!</i>
B-0108-C	0.65 GPM

B-0156 Add-On Faucet for Pre-Rinse Units

- Adds swing nozzle faucet to pre-rinse units
- 12" (152 mm) nozzle (062X)
- Stream regulator outlet (B-PT)
- Quarter-turn Eterna cartridge
- Lever handle
- 3/8" NPT female outlet and 3/8" NPT x 3" (76 mm) nipple for installation on existing rigid outlet base faucets (000358-40)



B-0156

Note: The B-0156 increases the height of a pre-rinse unit by approximately 4-1/4" (108 mm). Different length nozzle furnished upon request – single- or double-jointed. (See Accessories section, p. ACS3-4)

B-0155-LNEZ and B-0156-EZ EasyInstall Add-On Faucet for Pre-Rinse Units

- -EZ and -LNEZ models include the EasyInstall "pop-and-lock" riser installation feature for quick installation

EasyInstall



B-0155-LNEZ



B-0156-EZ



A
52

MODEL	CARTRIDGE	NOZZLE	HEIGHT	CLEARANCE	SPREAD	OUTLET	NOTES
B-0155	Eterna (1/4-turn)	6" Swing Nozzle (059X)	9-5/16"	6-3/16"	6"	B-PT Stream Regulator	3" (76 mm) nipple
B-0155-01LN	Eterna (1/4-turn)	—	—	—	—	—	4" (102 mm) nipple
B-0155-05	Eterna (1/4-turn)	6" Swing Nozzle (059X)	11-5/16"	8-3/16"	6"	B-PT Stream Regulator	5" (127 mm) nipple
B-0155-05CR	Cerama (1/4-turn)	6" Swing Nozzle (059X)	11-5/16"	8-3/16"	6"	B-PT Stream Regulator	5" (127 mm) nipple
B-0155-05LN	Eterna (1/4-turn)	—	—	—	—	—	Less nozzle
B-0155-064X	Eterna (1/4-turn)	16" Swing Nozzle (064X)	12-3/4"	9-5/8"	16"	B-PT Stream Regulator	3" (76 mm) nipple (see photo, left)
B-0155-CR	Cerama (1/4-turn)	6" Swing Nozzle (059X)	9-5/16"	6-3/16"	6"	B-PT Stream Regulator	3" (76 mm) nipple
B-0155-CR-LN	Cerama (1/4-turn)	—	—	—	—	—	Less nozzle
B-0155-LN	Eterna (1/4-turn)	—	—	—	—	—	Less nozzle
B-0155-LNEZ	Eterna (1/4-turn)	—	—	—	—	—	EasyInstall Add-on Faucet w/ "pop-n-lock" connection for easy installation on EasyInstall faucets; less nozzle (see photo)
B-0155-LNM	Eterna (1/4-turn)	—	—	—	—	—	-LN Master carton of 6
B-0155-M	Eterna (1/4-turn)	6" Swing Nozzle (059X)	9-5/16"	6-3/16"	6"	B-PT Stream Regulator	B-0155 Master carton of 6
B-0156	Eterna (1/4-turn)	12" Swing Nozzle (062X)	11-1/4"	8-1/8"	12"	B-PT Stream Regulator	3" (76 mm) nipple (see photo)
B-0156-05	Eterna (1/4-turn)	12" Swing Nozzle (062X)	13-1/4"	10-1/8"	12"	B-PT Stream Regulator	5" (127 mm) nipple
B-0156-CR	Cerama (1/4-turn)	12" Swing Nozzle (062X)	11-9/16"	8-1/8"	12"	B-PT Stream Regulator	3" (76 mm) nipple
B-0156-EZ	Eterna (1/4-turn)	12" Swing Nozzle (062X)	10-11/16"	8-7/16"	12"	B-PT Stream Regulator	EasyInstall Add-on Faucet w/ "pop-n-lock" connection for easy installation on EasyInstall faucets (see photo)
B-0156-M	Eterna (1/4-turn)	12" Swing Nozzle (062X)	11-1/4"	8-1/8"	12"	B-PT Stream Regulator	B-0156 Master carton of 6
B-0157	Eterna (1/4-turn)	18" Swing Nozzle (065X)	13-1/4"	10-1/8"	18"	B-PT Stream Regulator	3" (76 mm) nipple (see photo, left)
B-0157-05	Eterna (1/4-turn)	18" Swing Nozzle (065X)	15-1/4"	12-1/8"	18"	B-PT Stream Regulator	5" (127 mm) nipple
B-0157-CR	Cerama (1/4-turn)	18" Swing Nozzle (065X)	13-1/4"	10-1/8"	18"	B-PT Stream Regulator	3" (76 mm) nipple
B-0157-M	Eterna (1/4-turn)	18" Swing Nozzle (065X)	13-1/4"	10-1/8"	18"	B-PT Stream Regulator	B-0156 Master carton of 6
B-0158	Eterna (1/4-turn)	14" Swing Nozzle (063X)	11-15/16"	8-13/16"	14"	B-PT Stream Regulator	3" (76 mm) nipple
B-0158-CR	Cerama (1/4-turn)	14" Swing Nozzle (063X)	11-15/16"	8-13/16"	14"	B-PT Stream Regulator	3" (76 mm) nipple (see photo, left)





Note: Spray Valve features are available in this G-12 Pre-Rinse Unit section on pages A54-A55

SPRAY VALVE MODEL	DESCRIPTION	GPM (at 60 PSI)	CLEANABILITY (ASTM F2324)	KEY DIFFERENTIATOR	APPLICATION	
	B-0107	1.15 GPM/ (4.35 Lpm)	7.5 Ozf (212 Gramf)	The industry standard spray valve with legendary performance and reliability	Designed for heavy use in commercial kitchens. Superior quality and great for most general applications, and backed by decades of trusted satisfaction	
	B-0107-035					35° Angle Spray Valve
	B-0107-090					90° Angle Spray Valve
	B-0107-M					B-0107 Master carton (12)
	B-0107-QD	0.65 GPM/ (2.5 Lpm)	4.4 Ozf (125 Gramf)	B-0107-C models have the lowest flow rate of any commercial brand; is endorsed by the Green Restaurant Association	Rinsing trays and plates without baked-on residue. Choose this spray valve when water and energy conservation are the foremost need, but you want the B-0107 reputation	
	B-0107-C					Ultimate Low Flow Spray Valve
	B-0107-C35					Ultimate Low Flow 35° Angle Spray Valve
	B-0107-C90					Ultimate Low Flow 90° Angle Spray Valve
	B-0107-J	1.07 GPM (4.1 Lpm)	7.2 Ozf (204 Gramf)	Powerful cleaning capability; combines time, water and energy savings with a reduction in cleaning times	Clean baked-on or sticky residue while still conserving water. This spray valve saves time, energy and water while cleaning stubborn residue effectively	
	B-0107-J90					Low Flow 90° Angle Spray Valve
	B-0108	1.07 GPM/ (4.1 LPM)	7.2 Ozf (204 Gramf)	Unique ergonomic design and easy lock-down mechanism for reduced user fatigue and eliminated heat transfer. Now with 1.07 GPM energy- and water-saving flow rate	Designed for heavy use in commercial kitchens where employees use for extended periods. Superior quality and great for most general applications, and comfortable and easy to use	
	B-0108-C					JeTSpray Low Flow Ergonomic Spray Valve





Spray Valve Assemblies using the B-0107 (1.15 GPM) Spray Valve, the B-0107-C Ultimate Low Flow Spray Valve (0.65 GPM) and the B-0108 JeTSpray Valve (1.07 GPM)

B-0107 Pre-Rinse Spray Valve

- 1.15 GPM (4.35 Lpm) at 60 PSI
- Spray force 7.5 Ozf (212 Gramf)
- Connects directly to T&S flexible stainless steel hose with grip handle
- Designed for heavy use in commercial kitchens
- Self-closing cartridge shuts off when handle is released
- Includes hose washer and hold-down ring (000907-45)
- 3/4"-14 UN male thread inlet

B-0107 Spray Face (1.15 GPM)



B-0107 Spray Valve Exploded View

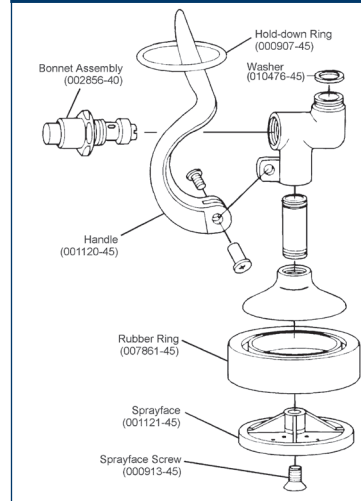

DID YOU KNOW?

70 years ago, the T&S Brass **B-0107** was the first spray valve introduced to the foodservice plumbing market

B-0107-035 Pre-Rinse Spray Valve

- 1.15 GPM (4.35 Lpm) at 60 PSI
- Spray force 7.5 Ozf (212 Gramf)
- 35° angle spray valve head
- Connects directly to T&S flexible stainless steel hose with grip handle
- Designed for heavy use in commercial kitchens
- Self-closing cartridge shuts off when handle is released
- Includes hose washer and hold-down ring (000907-45)
- 3/4-14 UN male thread inlet



B-0107-090 Pre-Rinse Spray Valve

- 1.15 GPM (4.35 Lpm) at 60 PSI
- Spray force 7.5 Ozf (212 Gramf)
- 90° angle spray valve head
- Connects directly to T&S flexible stainless steel hose with grip handle
- Designed for heavy use in commercial kitchens
- Self-closing cartridge shuts off when handle is released
- Includes hose washer and hold-down ring
- 3/4-14 UN male thread inlet

B-0107-QD Pre-Rinse Spray Valve

- 1.15 GPM (4.35 Lpm) at 60 PSI
- Spray force 7.5 Ozf (212 Gramf)
- Pre-rinse spray valve with quick-disconnect
- Connects directly to T&S hose reels
- Includes hose washer and hold-down ring
- Includes handle (002881-40) and stainless steel quick-disconnect (AW-5B)
- 3/8" NPT female inlet
- Requires (017960-25) adapter to connect to T&S hoses with 7/8-20 UN female ends (sold separately)

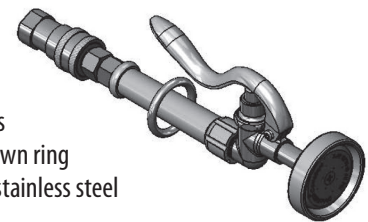

B-0107-C Ultimate Low Flow Spray Valve

- 0.65 GPM (2.5 Lpm) at 60 PSI
- Spray force 4.4 Ozf (125 Gramf)
- High performance fan jet with knife action spray
- Can be used with any T&S pre-rinse assembly instead of B-0107 spray valve
- Significantly saves water and energy
- 3/4-14 UN male thread inlet

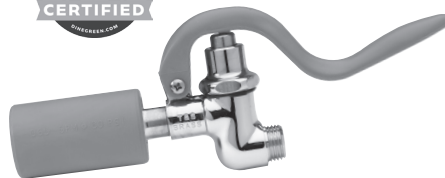

B-0107-CM Low flow spray valve Master Box (12)

Spray Valve Assemblies using the B-0107-C Ultimate Low Flow Spray Valve (0.65 GPM), the B-0108-C JeTSpray Valve (0.65 GPM) and B-0107-J (1.07 GPM)

B-0107-C35 Low Flow Spray Valve

- 0.65 GPM (2.5 Lpm) at 60 PSI
- Spray force 4.4 Ozf (125 Gramf)
- B-0107-C with 35° angle spray valve head
- Fan jet with knife action spray
- Can be used with any T&S pre-rinse assembly instead of B-0107
- Conserves water and saves energy
- 3/4-14 UN male thread inlet



B-0107-C Exploded Spray Valve

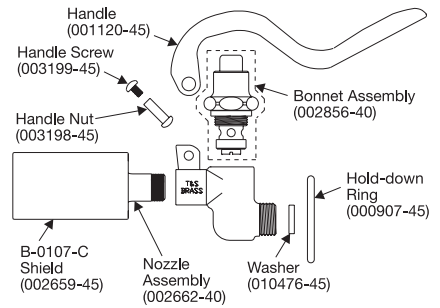

B-0107-C90 Same as B-0107-C35 except with 90° angle spray valve

B-0107-J Low Flow Spray Valve

- 1.07 GPM (4.1 Lpm) at 60 PSI
- Spray force 7.2 Ozf (204 Gramf)
- Powerful cleaning capability makes pre-rinse tasks easier
- Fan jet with knife action spray
- Tough baked-on foods come off faster
- Can be used with any T&S pre-rinse assembly
- Conserves water and saves energy
- 3/4-14 UN male thread inlet

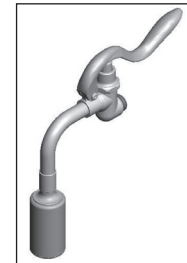
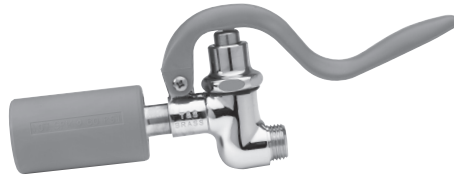

B-0107-J90 Low flow 90° angle spray valve

B-0108 JeTSpray Pre-Rinse Spray Valve



- 1.07 GPM (4.1 Lpm) at 60 PSI
- Spray force 7.2 Ozf (204 Gramf)
- Forged brass valve body – fast action stainless steel trigger
- Ergonomic design helps reduce fatigue caused by repetitive tasks
- Heat insulated touch points on handle with crush resistant grip
- Vandal resistant valve cap
- Tested to two million cycles plus
- Smart one-handed trigger lock
- Removable screen filter
- Quick change replacement parts
- Ergonomic design provides comfort for long periods of use
- 7/8-20 UN male thread inlet
- Connects to T&S "H2A" hose assemblies (without grip handle)



B-0108-C JeTSpray Low Flow Spray Valve



- 0.65 GPM (2.5 Lpm) at 60 PSI
- Spray force 4.6 Ozf (130 Gramf)
- Forged brass valve body – fast action stainless steel trigger
- Ergonomic design helps reduce fatigue caused by repetitive tasks
- Retrofits most commercial pre-rinse units and hoses
- Heat insulated touch points on handle with crush resistant grip
- Vandal resistant valve cap
- Tested to two million cycles plus
- Smart one-handed trigger lock
- Removable screen filter
- Quick change replacement parts
- Ergonomic design provides low flow and comfort for long periods of use
- 7/8-20 UN male thread inlet
- Connects to T&S "H2A" hose assemblies (without grip handle)



018200-40 Swivel For Pre-Rinse Spray Valves

- Includes: (1) 7/8-20 UN female and male swivel
(2) replacement seals
- Allows a 360° range of rotation and motion while using spray valves, reducing user fatigue
- Retrofit between hose handle and spray body
- Makes spray valve assemblies more ergonomic
- Available for use with any T&S pre-rinse spray valve
 - For **B-0108 Series** spray valves – install the swivel directly between the hose and spray valve
 - For **B-0107 Series** spray valves – install the swivel between the hose and grip handle

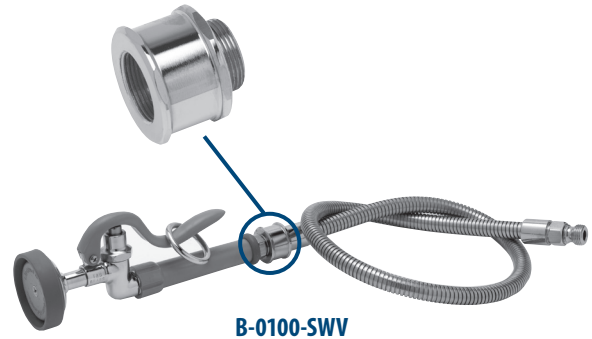
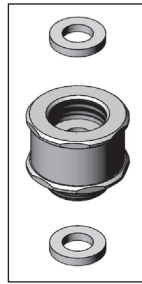

B-0100-SWV

B-0104 Wall Hook Outlet

- Wall mounted hose connection with flange
- 3/8" NPT female inlet
- 3/4"-14 male hose thread on outlet

B-0104-A Same as B-0104 except outlet is 3/8" NPT male



B-0104-D Dummy Wall Hook

- Attaches to wall with screws (furnished)
- Flange diameter 2" (51 mm)
- No inlet connection



B-0109-01 Wall Bracket

- 6" (152 mm) wall bracket (-B models)
- Fits 3/8" pre-rinse risers
- Adjustable length by field cutting unthreaded end of pipe



B-0109-01M Master Box (12)	B-0109-04 18" (457 mm)
B-0109-01VR 6" Vandal-resistant wall bracket assembly with vandal-resistant mounting hardware	B-0109-05 24" (610 mm)
B-0109-02 9" (229 mm)	B-0109-06 3" (76 mm)
B-0109-03 12" (305 mm)	B-0109-07 2-3/8" (60 mm)
B-0109-03VR 12" Vandal-resistant wall bracket assembly with vandal-resistant mounting hardware	B-0110 Same as B-0109-01 except fits 1/2" riser
	B-0159 Fits 3/4" NPT risers

B-0119 Riser Support

- "Bi-pod" clamp assembly
- For use where no walls are available for 3/8" riser support



B-0166 Dummy Wall Hook

- Attaches to wall with screws (furnished)
- Flange diameter 2" (51 mm)
- No inlet connection



B-0425 1/2" Supply Nipple

B-0425-M Master Box (2)

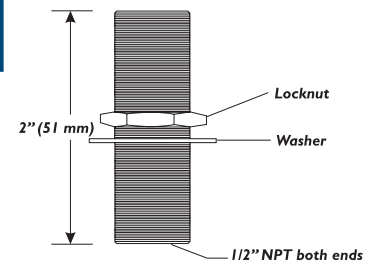

Other Supply Nipples:

Supply Nipple	Length
3/8" B-0428	2-1/8" (54 mm)
B-0429	3-3/8" (86 mm)
1/2" B-0425	2" (51 mm)
B-0426	3-3/8" (86 mm)
3/4" B-0427	2-1/2" (64 mm)

These brass supply nipples have tapered pipe threads on each end and a running thread between. They are used on faucets with female inlets to make up tightly to vertical or horizontal surfaces. Washer and nut included.

B-0970-FE
Dual Check Vacuum Breaker

- Designed for continuous pressure use
- 3/8" NPT female inlet and outlet
- Polished chrome plated
- Design prevents back siphonage and back-flow
- Certified to CSA-B64.8



BR-10
Brush Attachment

- High-quality nylon bristle brush with rubber collar
- For B-0107 pre-rinse spray valves
- Can be supplied on many T&S spray or pre-rinse assemblies



B-KF
Built-in Protective Flange

- For use when a disappearing hose arrangement is desired
- Flange fits 1-9/16" (40 mm) hole
- Fits surfaces up to 1/8" (3 mm) thick

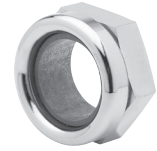

B-KG Same as B-KF but fits sheet metal 3/16" (5 mm) thick

SQ-0093
Wall Outlet

- 3/8" NPT flanged female inlet
- 2" (51 mm) diameter flange
- 3/4"-14 male hose thread on outlet



A
57

T&S Tees: the Solution to Add-On Accessory Tees in the Kitchen

Do you need an additional water source from your T&S EasyInstall pre-rinse unit or mixing faucet? Is it hard to install? **The T&S solution:** our B-TEE-RGD for pre-rinses, and the B-TEE-EZK for mixing faucets. T&S tees are easily retrofitted.

Tee Applications

Tees are used on pre-rinse units and mixing faucets to supply

water to accessory applications such as chemical injectors (for cleaning jobs, etc.) They are not intended to introduce chemicals into the T&S pre-rinse unit or mixing faucet. A backflow prevention device should be installed if it is not included with the accessory device.

B-TEE-EZK
Swivel Tee Assembly

Easy Install

- EasyInstall swivel tee assembly
- Designed for use with T&S mixing faucets with swivel outlets
- Swivel adapter accepts all T&S standard swing nozzles
- Chrome plated

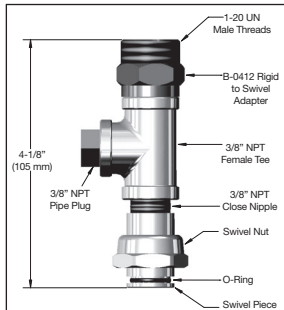

Note: Swivel to Rigid Star Washer Included

B-TEE-RGD
Rigid Tee Assembly

- Rigid tee assembly
- Designed for use with T&S pre-rinses
- Can be easily installed to add another water source in the kitchen
- Chrome plated

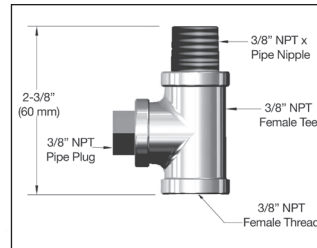

Note: 3/8" Hex L-Key included

B-0133-B-TEE
with B-TEE-RGD Rigid Tee Assembly

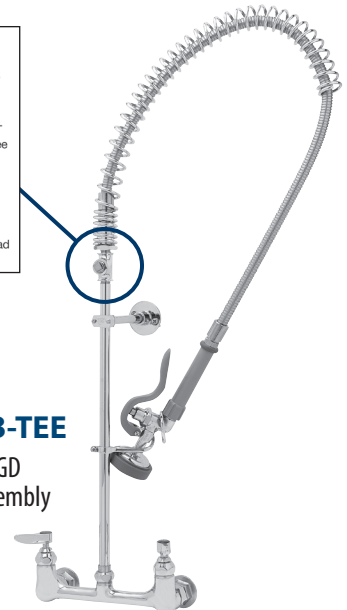



RELIABILITY BUILT IN™

G-12

B Pot, Kettle and Glass Fillers





RELIABILITY BUILT IN™

Tap Into T&S and Everpure's Tap Water Filtration Solution

Your Assurance of Serving the Best Tap Water

Why take a chance on serving tap water that does not meet your customer's expectations?

Tap water is one of the fastest-growing beverage orders in U.S. restaurants. Tap water orders currently make up to 8% of the 50 billion servings of beverages ordered in restaurants.¹ People today are more aware of the importance of drinking water in their daily lives, so the demand for high-quality tap water is increasing.

When customers order tap water, they expect it to be good-tasting, odor-free and contaminant-free. It is truly a clear reflection of the perceived cleanliness of one's restaurant or facility.

In response to this growing trend, **T&S Brass**, a leading manufacturer of foodservice plumbing products, and **Everpure**, the best-known name in water filtration systems around the world, are partnering to offer an optimal solution for serving great-tasting and safe tap water to your clientele.

We are now offering T&S glass fillers, bubblers and water stations with Everpure water filtration systems.

Besides restaurants and foodservice locales, hydration stations are becoming more and more available in public places. The reuse of personal water bottles is a growing trend; therefore the need for good-tasting tap water is a necessity.

Also, "green-minded" customers who opt for tap water are aware they are helping to reduce the environmental impact by not ordering bottled water.

Check out our T&S/Everpure water filtration models on pages B4-6.

"When customers receive good-tasting, odor-free and contaminant-free tap water, it is a clear reflection of the perceived cleanliness of your restaurant or facility."

Everpure's replaceable filter cartridge (B-WFC, left) and the docking station (B-WFDS, above)



B-1210-WFK glass filler model with water filtration system

Demand for serving good-tasting Filtered Tap Water is trending up in restaurants and other public places:

- Hydration stations
- Convenience stores
- Recreational facilities
- Outdoor activity centers
- Schools and churches
- Exercise studios/fitness centers
- Hospitals
- Airports and cruise ships

Additional benefits of serving the best Filtered Tap Water:

- It's more environmentally responsible than bottled water
- "Green" practices will save money for your restaurant



¹ Source URL <http://nrm.com/archive/customers-turn-tap-water-restaurants>

Glass Fillers and Water Stations

Deck Mount Pedestal Glass Fillers and Water Stations with Water Filtration

These three glass filler models include water filtration (see drawing below):

B-1210-WFK

- 8" height from base of flange to outlet

B-1210-01-WFK

- 10" height from base of flange to outlet

B-1210-12-WFK

- 12" height from base of flange to outlet



B-1230-WFK Water Station with Water Filtration

This complete solution includes pedestal glass filler, stainless steel drip pan, grid, drain and water filtration kit with supply lines



B
4

Glass Filler/Water Filtration Components

B-1210-WFK

This drawing shows a Glass Filler with Water Filtration components. See the B-WFK for individual parts included in Water Filtration models.

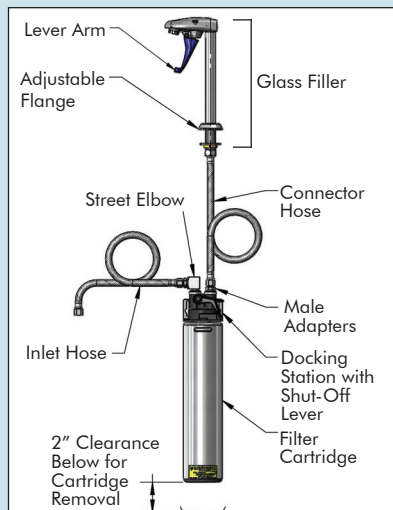

Docking Station, Water Filter Cartridge and Starter Kits

FEATURES

B-WFDS Docking Station

- Includes integral shut-off valve for easy cartridge replacement
- Includes mounting bracket and screws
- Engineered for durability, strength and longevity in foodservice applications
- Will not corrode
- Wetted parts pass NSF extraction tests
- Inlet-outlet size: 3/8" NPT female
- Accepts B-WFC water filter cartridge



B-WFDS

B-WFC Water Filter Cartridge

- Balanced cartridge for optimum performance in varying water conditions
- 15,000 gallon capacity
- 0.5 micron rating
- Reduces chlorine taste and odor
- NSF certified under NSF/ANSI standards 42 and 53



B-WFC

B-WFK Water Filtration Starter Kit

Includes docking station (B-WFDS), cartridge (B-WFC) and all necessary installation components:



- (1) 3/8" street elbow (148X)
- (2) 3/8" NPT x 3/8" compression male adapters (006101-45)
- (1) 20" stainless steel braided inlet hose 3/8" compression female (013146-45)
- (1) 18" polymer braided connector hose 3/8" compression female x 1/2" NPSM (5EF-0005)
- (2) mounting screws

Additional technical information and model specs available online at www.tsbrass.com





Glass Fillers with Water Filtration

NEW! T&S Glass Fillers and Water Stations with Everpure water filtration system

- Provides filtered tap water to ensure good-tasting, odor-free and contaminant-free water is served in your facility

B-1210-WFK Glass Filler with Water Filtration

Glass Filler:

- B-1210 countertop mounted push back glass filler, with 2" dia. (51 mm) adjustable flange at base of pedestal
- 8" (203 mm) high from base of flange to outlet
- Torx key adjustable flow outlet
- Dark blue push back arm
- Instantaneous shut-off
- Mounted height: 9-5/16" (236 mm)

Water Filtration:

Includes B-WFK docking station, filter cartridge and all necessary installation components:

- (1) 3/8" street elbow (148X)
- (2) 3/8" NPT x 3/8" compression male adapters (006101-45)
- (1) 20" polymer braided inlet hose 3/8" compression (013146-45)
- (1) 18" stainless steel braided connector hose 3/8" compression x 1/2" NPSM (5EF-0005)
- (2) mounting screws

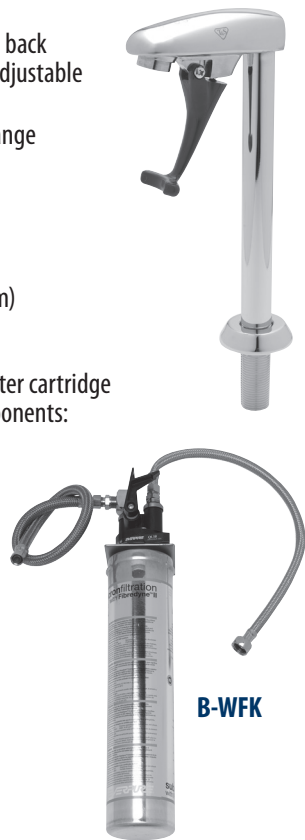

B-WFK

B-1210-01-WFK Same as B-1210-WFK except with 10" (254 mm) pedestal height
B-1210-12-WFK Same as B-1210-WFK except with 12" (305 mm) pedestal height

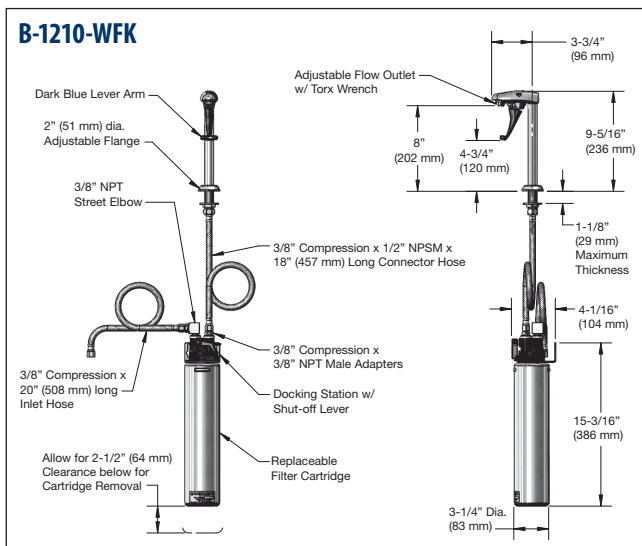

B-1230-WFK Water Station with Water Filtration

Water Station:

- B-1230 water station with B-1210 countertop mounted push-back pedestal glass filler with 2" dia. (51 mm) adjustable flange at base of pedestal
- 8" (203 mm) high from base of flange to outlet
- Torx key adjustable flow outlet
- Dark blue push back arm
- Instantaneous shut-off
- Mounted height: 9-5/16" (236 mm)
- Stainless steel drip pan (010123-45)
- Drip pan grid (183F)
- Drip pan drain with 1-1/4" dia. (32 mm) tailpiece (010126-45)

Water Filtration:

Includes B-WFK docking station, filter cartridge and all necessary installation components:

- (1) 3/8" street elbow (148X)
- (2) 3/8" NPT x 3/8" compression male adapters (006101-45)
- (1) 20" stainless steel braided inlet hose 3/8" compression female (013146-45)
- (1) 18" stainless steel braided connector hose 3/8" compression x 1/2" NPSM (5EF-0005)
- (2) mounting screws



B-WFK

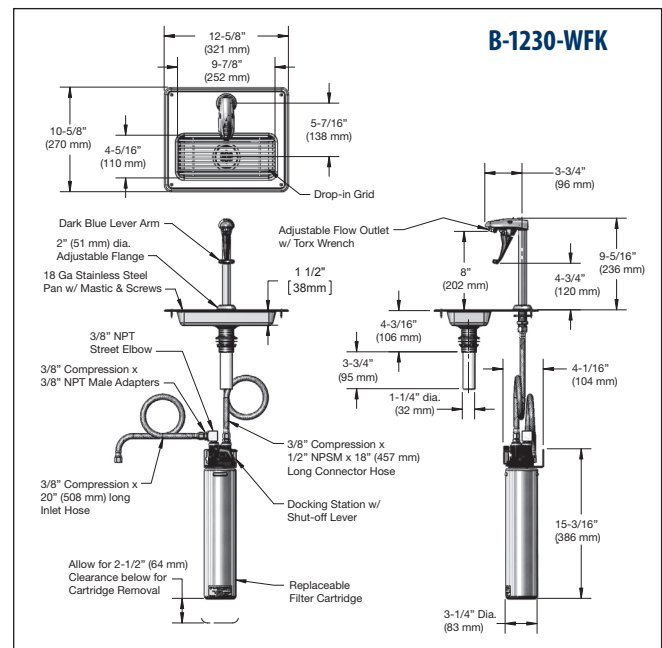

Water Filtration Components

NEW! T&S Glass Fillers and Water Stations with Everpure water filtration system

- Provides filtered tap water to ensure good-tasting, odor-free and contaminant-free water is served in your facility

B-WFDS

Water Filtration Docking Station

- Includes integral shut-off valve for easy cartridge replacement
- Includes mounting bracket and screws
- Engineered for durability, strength and longevity in foodservice applications
- Will not corrode
- Wetted parts pass NSF extraction tests
- Inlet-outlet size: 3/8" NPT female
- Accepts B-WFC water filter cartridge
- Change cartridges on a regular 6-month preventative maintenance program
- Change cartridges when capacity is reached or when pressure decreases
- Always flush the filter cartridge at time of installation and cartridge change



B-WFC

Water Filtration Cartridge

- Balanced cartridge for optimum performance in varying water conditions
- 15,000 gallon capacity
- 0.5 micron rating
- Reduces chlorine taste and odor
- NSF certified under NSF/ANSI standards 42 and 53
- Maximum flow rate: 2.5 GPM (9.5 LPM)
- Pressure requirements: 10-125 PSI, non-shock
- Temperature: 35°-100° F (2°-38° C)



**B
6**

B-WFK

Water Filtration Starter Kit

Includes a B-WFDS docking station, B-WFC filter cartridge and all necessary installation components:

- (1) 3/8" street elbow(148X)
- (2) 3/8" NPT x 3/8" compression male adapters (006101-45)
- (1) 20" stainless steel braided inlet hose 3/8" compression female (013146-45)
- (1) 18" stainless steel braided connector hose 3/8" compression female x 1/2" NPSM (5EF-0005)
- (2) mounting screws



B-1210-WFK Glass Filler model with water filtration system



Glass Fillers

B-1200

Push Back Glass Filler

- Wall-mount, 3/8" NPT female inlet
- 2" dia. (51 mm) adjustable slip flange
- Torx key adjustable flow outlet
- 5-3/16" (131 mm) from front of filler to wall
- Dark blue push back arm
- Instantaneous shut-off



B-1200-M Master Box (12)

B-1201 Same as B-1200 except without adjustable flange; 4-3/8" from front of filler to wall

B-1202

Push Back Glass Filler

Same as B-1200 except:

- Extended 3-3/4" (95 mm) nipple with 1/4" NPT male tailpiece for 1/4" sweat connection
- Use for mounting on ice cabinets up to 2-1/4" (57 mm) thick





Glass Fillers

All T&S Glass Fillers have:

- A dark blue actuation lever arm that allows for easy filling of pitchers and styrofoam cups
- Easy adjustment of flow control on torx key flow outlet

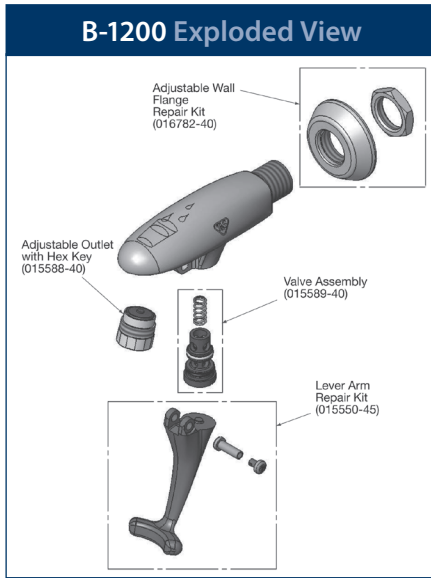

**B-1210
Pedestal Push Back Single Glass Filler**

- Countertop mounted glass filler
- 2" dia. (51 mm) adjustable flange on shank of pedestal
- 1/2" NPT male shank
- 8" (203 mm) base of flange to outlet
- Mounted height: 9-5/16" (236 mm)
- Torx key adjustable flow outlet
- Dark blue push back arm
- Instantaneous shut-off



- B-1210-01** Same as B-1210 except base of flange to outlet is 10" (254 mm)
- B-1210-01M** Master Box (6)
- B-1210-M** Master Box (6)
- B-1210-12** Same as B-1210 except base of flange to outlet is 12" (305 mm)
- B-1211** Same as B-1210 except base of flange to outlet is 4" (101 mm)

**B-1205
Push Back Glass Filler**

- Wall-mount with 3/8" NPT male inlet
- Torx key adjustable flow outlet
- 4-3/8" (111 mm) from front of filler to wall
- Dark blue push back arm
- Instantaneous shut-off



- B-1204** Same as B-1205 except with 1/2" NPT male inlet
- B-1205-M** Master Box (12)

**B-1215
Pedestal Push Back Double Glass Filler**

- Countertop mounted double glass filler
- 2" dia. (51 mm) adjustable flange on shank of pedestal
- 1/2" NPT male shank
- 8-1/4" (209 mm) base of flange to outlet
- Torx key adjustable flow outlet
- Valves mounted 180° opposite
- (2) Dark blue push back arms
- Instantaneous shut-off



**B
7**

**B-1220
Pedestal Push Back Glass Filler,
Female Inlet**

- Countertop mounted glass filler
- 2" dia. (51 mm) deck flange
- 3/8" NPT female inlet
- Designed especially for mounting on electric water coolers
- 8" (204 mm) base of flange to outlet
- Torx key adjustable flow outlet
- Dark blue push back arm
- Instantaneous shut-off



- B-1222** Same as B-1220 except inlet is 1/2" NPT female



Glass Fillers

All T&S Glass Fillers have:

- A dark blue actuation lever arm that allows for easy filling of pitchers and styrofoam cups
- Easy adjustment of flow control on torx key flow outlet

B-1225 Combination Glass and Pitcher Filler

- Dual purpose unit – glass filler for glasses, and 6" (152 mm) swing nozzle for pitchers (059X)
- 2" diameter (51 mm) adjustable flange on shank of pedestal
- 1/2" NPT male shank
- 8-11/16" (220 mm) base of flange to outlet
- 15-1/4" (387 mm) base of flange to outlet of pitcher filler
- 4-arm handle for water flow to gooseneck (175FC)
- Torx key adjustable flow outlet on glass filler
- Dark blue push back arm
- Instantaneous shut-off on glass filler



Adapter Chart

When specified, these adapters will be provided in place of the 1/2" NPT male adapter normally furnished.

052A	1/4" NPT female
053A	3/8" NPT male (Chicago)
054A	3/8" NPT female
055A	1/2" NPT male
056A	1/2" NPT female
057A	3/4" NPT male
058A	3/4" NPT female
059A	Garden Hose female
172A	1/4" NPT male (Fisher)
098A	Connect two hoses

B
8

B-1230 Water Station

- 10-5/8" (270 mm) x 12-5/8" (321 mm) stainless steel drip pan with drop-in grid
- B-1210 push back glass filler with 7-3/4" (197 mm) clearance from tip to pan (other heights available on request)
- Coupling nut and 1/4" (6 mm) sweat tailpiece for copper tube connection
- 2-1/4" diameter grid drain
- Drain 1-1/4" x 3-3/4" long, 17 gauge tailpiece



- B-1230-12** Same as B-1230 except with 12" (305 mm) outlet height from top of pan
- B-1231** Stainless steel drip pan, drop-in grid and drain

B-1230 Water Station Explosion

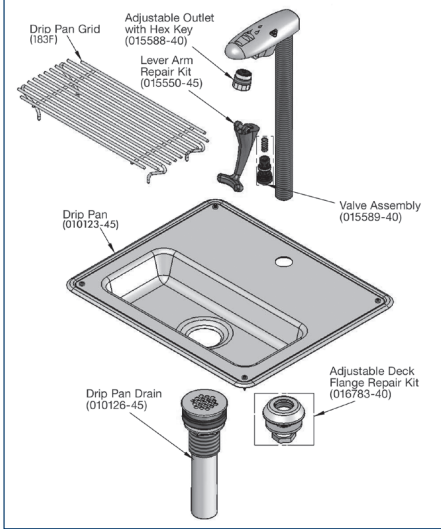

B-1235 Water Station with Splash Guard

- Same as B-1230 except with 6" (152 mm) high splash guard around back and sides to prevent excess water from splashing surrounding areas



Pot, Kettle and Glass Fillers

B-0102 Pot and Glass Filler

- Automatic shut-off valve with 90° plain end curved nozzle (002866-40)
- Hold-down ring for continuous flow of water
- B-0068-H 68" flexible stainless steel hose
- 73-5/16" (1862 mm) overall length
- 1/2" NPT male adapter (055A)



B-0102-B Pot and Glass Filler

- Same as B-0102, but with straight nozzle (002864-40)
- Hold-down ring for continuous flow of water
- 72-7/16" (1861 mm) overall length
- 1/2" NPT male adapter (055A)

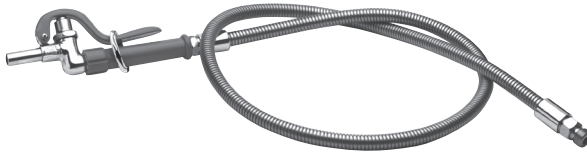

B-0107-A Filler Valve Unit

- Automatic shut-off valve with straight nozzle and 2.2 GPM aerator (B-0199-01)
- Hold-down ring for continuous flow of water (not shown)
- 3/4-14 UN male threads
- Not rated for commercial warewashing



B-1413 Pot and Kettle Filler

- Squeeze valve with quick-connect socket and automatic shut-off valve (B-1420)
- Quick connect hook nozzle (B-1424)
- Hold-down ring for continuous flow of water
- B-0068-H 68" flexible stainless steel hose
- 76-5/16" (1938 mm) overall length of unit
- 1/2" NPT male inlet adapter (055A)



B-0102-A Pot Filler Hose Assembly

- Automatic shut-off valve with plain end hook nozzle for use on large pots and steam kettles (002851-40)
- Hold-down ring for continuous flow of water
- B-0068-H 68" flexible stainless steel hose
- 75-1/2" (1918 mm) overall length
- 1/2" NPT male adapter



B-0102-C Pot and Glass Filler with Aerator

- Same as B-0102, but with B-0199-01 2.2 GPM aerator outlet (009937-40)
- Hold-down ring for continuous flow of water
- 73-5/16" (1863 mm) overall length
- 1/2" NPT male adapter (055A)



B-0107-B Spray Valve Unit

- Automatic shut-off valve with straight nozzle and rosespray outlet
- Hold-down ring for continuous flow of water (not shown)
- 3/4-14 UN male threads
- Not rated for commercial warewashing



Pot and Glass Filler Options

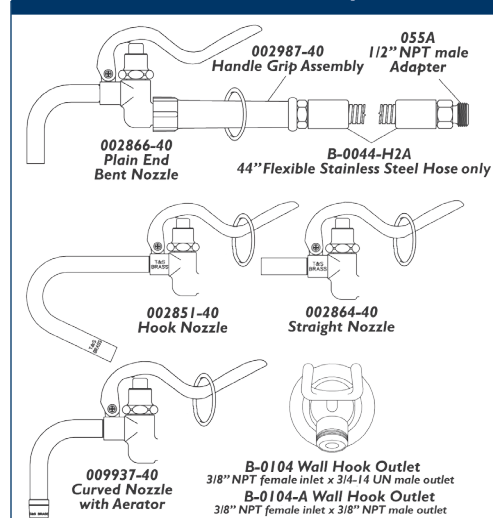

Dipperwell Faucets

B-2282 Dipperwell Faucet

- 6-1/16" (154 mm) overall height
- 1-11/16" (43 mm) clearance
- 2-3/4" (70 mm) shank
- 2-5/16" (58 mm) nozzle reach
- 1/2" NPSM shank with sweat fitting for 5/16" tubing
- Also available with flow control:

Model No. Flow (GPM)

B-2282-F03	0.25
B-2282-F05	0.40
B-2282-F07	0.70
B-2282-F10	0.90
B-2282-F12	1.20
B-2282-F15	1.40
B-2282-F20	2.00

To order:
Select flow desired,
then add suffix to
model number.

Ex.: B-2282-F03 for
0.25 GPM



006678-45 Dipperwell Bowl

- Keeps ice cream scoops and paddles clean and sanitized
- Stainless steel removable internal cup and outer bowl
- 1-1/2" (38 mm) brass tailpiece drain
- Sits flush with table top
- Drains quickly and easily



B-2282-01 Includes B-2282
Dipperwell faucet and
006678-45 Dipperwell bowl

B-2282-01-F05 Same as
B-2282-01 except with
0.40 GPM flow tower

B-2282-01-M10 Master pack
includes (10) B-2282-01
faucet and bowl assemblies

Elevated Kettle Filling Faucets

B-0270 Double Pantry Faucet with Elevated Swing Nozzle



- Single hole deck mount mixing faucet (B-0300-LN)
- Quarter-turn Eterna cartridges with crossflow prevention
- 18" (457 mm) swing nozzle (065X) with rigid to swivel adapter
- Swivels from top
- 3/8" NPT 18" riser (000369-40)
- 27-5/8" (702 mm) clearance
- Lever handles with color coded indexes
- 18" flexible inlet hoses (compression fittings for 5/8" O.D. tubing or 1/2" NPSM male thread)

B-0270-144XVF22 18" (456 mm) swing nozzle (065X), vandal resistant aerator and 6" (152 mm) riser, 15-15/16" (405 mm) clearance

B-0271 12" (305 mm) swing nozzle (062X), 25-1/4" (641 mm) clearance

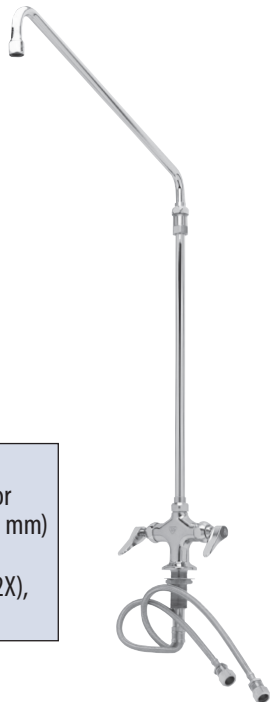

B-0275 Single Pantry Faucet with Elevated Swing Nozzle



- Single hole, single temperature faucet (B-0305-LN)
- Quarter-turn Eterna cartridge
- 18" (457 mm) swing nozzle (065X)
- Swivels from top
- 3/8" NPT 18" riser (000369-40)
- 27-1/4" (692 mm) clearance
- Lever handle with color coded index
- 1/2" NPSM male shank
- Tailpiece and nut for 1/4" NPT connection included (150A)

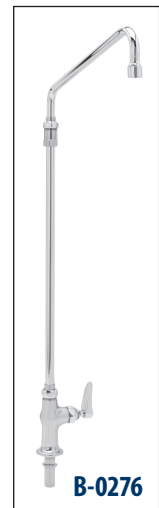
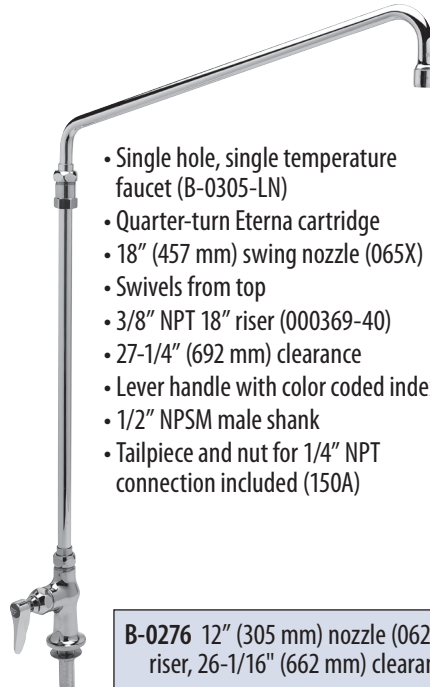

B-0276

B-0276 12" (305 mm) nozzle (062X), 18" (457 mm) riser, 26-1/16" (662 mm) clearance

"Wok Wand" Faucets

B-0575 Back Mount Range Faucet

- Back mount range faucet
- For cold water only
- 13-3/4" (349 mm) nozzle with 2.2 GPM aerator
- 3/8" NPT female inlet
- ON-OFF control with swing nozzle:
 - ON when nozzle is in center position
 - OFF when nozzle is swung to left or right



B-0576 Same as B-0575 except with 3/8" male inlet
B-0577 Same as B-0575 except with 1/2" male inlet
B-0577-09 Same as B-0577 except with 8-7/8" (225 mm) nozzle length and 1/2" NPSM male inlet

B-0578-01 "Wok Wand" Range Faucet

- Single hole wall mount range faucet
- 1/2" NPT male inlet
- 2" diameter (51 mm) slip flange
- 4" (102 mm) wrist action handle (B-WH4)
- 13-1/2" (334 mm) swing nozzle with 2.2 GPM aerator (002868-40)

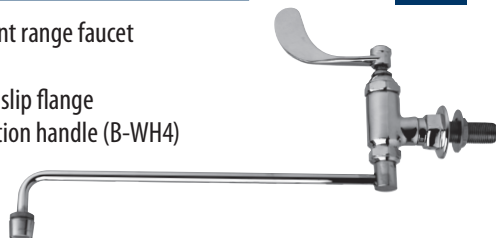

B-0579-01 Same as B-0578-01 except with 2" dia. (51 mm) flange with 1/2" BSPT NPT female inlet
B-0579 Same as B-0578-01 except with 1/2" BSPT female inlet

B-2343 Chinese Pedestal Faucet

- Pedestal mounted faucet
- 1/2" NPT male shank, 2" (51 mm) long
- 9" (229 mm) swing nozzle with 2.2 GPM aerator
- 6-1/4" (159 mm) clearance
- For cold water only
- ON-OFF control with swing nozzle:
 - ON when nozzle is in center position
 - OFF when nozzle is swung to left or right



**B
12**

Range Faucets and Pot Fillers

B-0300-102A-CR Pot Filler Faucet Assembly

- Single hole deck mount mixing faucet
- Ceramic cartridges with crossflow prevention
- Lever handles with color coded indexes
- B-0068-H 68" flexible stainless steel hose with spray valve hook nozzle (002851-40)
- 053A adapter connects to faucet
- (2) 18" long flex. stainless steel supply hose connectors, compression fittings
- Wall hook (B-0104-D)

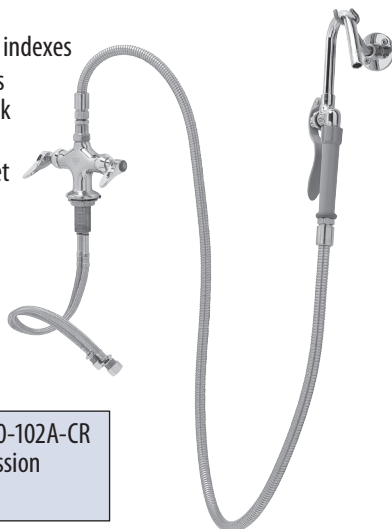

B-0300-102A Same as B-0300-102A-CR except with Eterna compression cartridges in mixing faucet

B-0300-PF Pot Filler Faucet Assembly

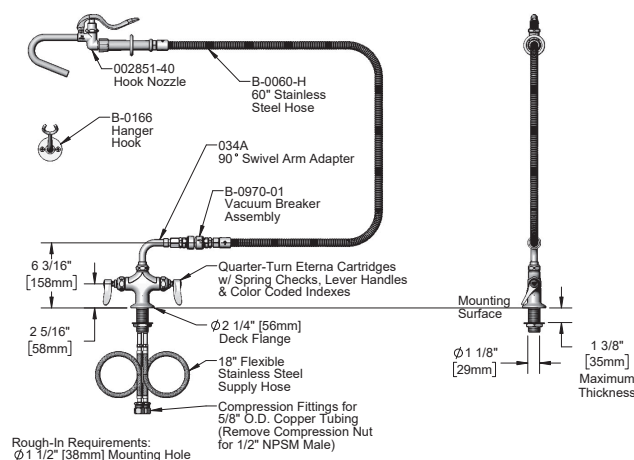

- Single hole deck mount mixing faucet
- Quarter-turn Eterna cartridges with crossflow prevention
- Lever handles with color coded indexes
- 90° swivel adapter (034A)
- Hook nozzle spray valve (002851-40)
- B-0060-H 60" flexible stainless steel hose
- B-0970-01 vacuum breaker assembly
- (2) 18" long flex. stainless steel supply hose connectors, compression fittings
- Wall hook (B-0166)

Range Faucets and Pot Fillers

B-0300-A16-WD
Pot Filler Faucet with Spray Unit

- Single hole deck mount mixing faucet
- Quarter-turn Eterna cartridges with crossflow prevention
- Lever handles with color coded indexes
- Add-on faucet with 16" swing nozzle with stream regulator outlet (064X) and 5" (127 mm) riser
- B-0107-C35 low flow (0.65 GPM) angle spray valve
- B-0060-H 60" stainless steel hose
- 90° swivel adapter (034A)
- B-0970-01 vacuum breaker assembly
- (2) 18" long flex. stainless steel supply hose connectors, compression fittings
- Wall hook (B-0166)
- 2019 DOE compliant pre-rinse spray valve

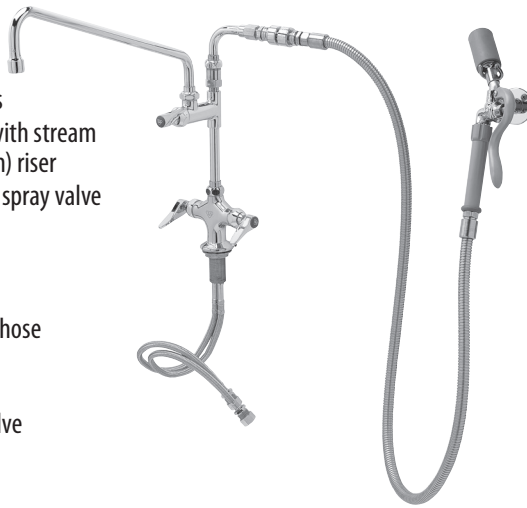

B-0305-102A-CR
Pot Filler Faucet Assembly



- Single control deck mount pantry faucet
- Quarter-turn ceramic cartridges
- Lever handle with color coded index
- 1/2" NPSM male threaded shank with optional 1/4" NPT tailpiece
- Hook nozzle spray valve (002851-40)
- B-0068-H 68" flexible stainless steel hose
- 053A adapter connects to faucet
- Wall hook (B-0104-D)

B-0305-PF96H-CR
Pot Filler Faucet Assembly

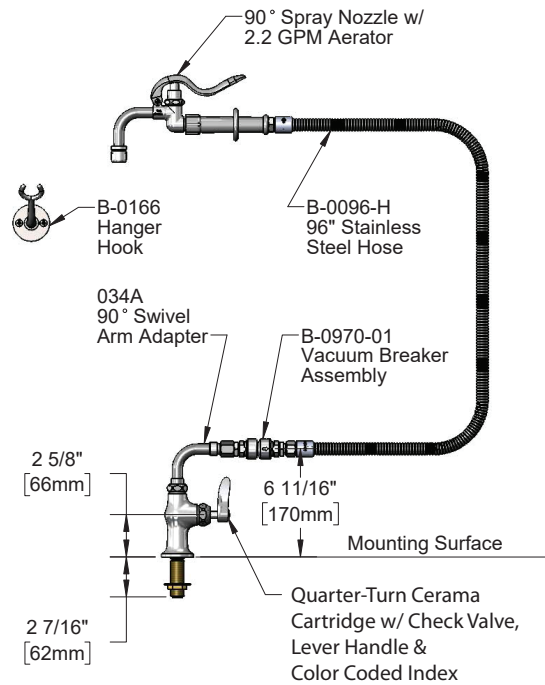

- Single control deck mount pantry faucet
- Quarter-turn ceramic cartridges
- Lever handle with color coded index
- 1/2" NPSM male threaded shank with optional 1/4" NPT tailpiece
- 90° spray nozzle with 2.2 GPM aerator
- B-0970-01 vacuum breaker assembly
- B-0096-H 96" flexible stainless steel hose
- 034A swivel arm adapter connects to faucet
- Wall hook (B-0166)

Range Faucets and Pot Fillers

B-0318-02 Pot Filler Faucet



- Single hole, single temperature deck mount faucet
- 360° swing nozzle with 2.2 GPM aerator (B-0199-01)
- Four-arm handle
- 1/2" NPSM male inlet with locknut and lock washer
- 14-7/8" (379 mm) clearance
- 16-3/4" (425 mm) overall height
- Tailpiece and nut for 1/4" NPT connection included (150A)
- Quarter-turn Eterna cartridge



B-0319 Single pantry faucet with 24" (068X) double-joint swing nozzle (right)



B-0590 Pot Filler Faucet



- Single hole, single temperature deck mount faucet
- 1/2" NPSM male inlet
- 18" (457 mm) double-joint nozzle (002848-40)
- Heat-resistant on-off volume control grip on nozzle end (035A)
- Tailpiece and nut for 1/4" NPT connection included (150A)
- Quarter-turn Eterna cartridge

B-0591 Same as B-0590 except with 24" (610 mm) double-joint nozzle (002872-40) (below)



B-0580 Pot Filler

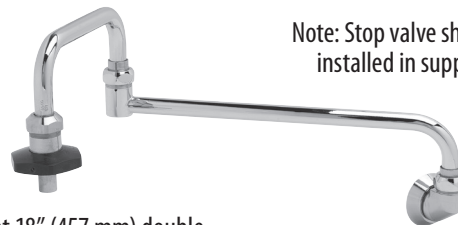

Note: Stop valve should be installed in supply line.

- Wall mount 18" (457 mm) double-joint nozzle (002848-40) with 2" dia. (51 mm) adjustable flange and 1/2" NPT female inlet
- Heat-resistant on-off volume control grip on nozzle end (035A)



B-0581 Same as B-0580 except with 24" (610 mm) double-joint nozzle (002872-40)

B-0585 Deck mount with 18" (457 mm) double-joint nozzle (002848-40) and swivel body with 1/2" NPT female inlet (000590-25) (above)

B-0584 Deck mount with 24" (610 mm) double-joint nozzle (002872-40) and swivel body with 1/2" NPT female inlet (000590-25)

B-0592 Pot Filler Faucet



- Single hole, single temperature wall mount faucet
- 18" (457 mm) double-joint nozzle (002848-40)
- Quarter-turn Eterna cartridge
- 2" dia. (51 mm) flange with 1/2" NPT female inlet
- Heat-resistant on-off volume control grip on nozzle end (035A)

B-0592-26-CH Same as B-0592 except with 26" double-joint swing nozzle and club handle

B-0592-LF20 Same as B-0592 except with 2.0 GPM flow control cartridge in nozzle

B-0592-CR Same as B-0592 except with ceramic cartridge

B-0592-LVR Same as B-0592 except with lever handle

B-0594 Same as B-0592 except with 24" (610 mm) double-joint nozzle (002872-40)

B-0594-CR Same as B-0594 except with ceramic cartridge

Range Faucets and Pot Fillers

B-0605 Pot and Kettle Filler

- Wall mount single temperature faucet
- 2" dia. (51 mm) flange with 1/2" NPT female inlet
- Vacuum breaker on outlet (B-0968)
- B-0068-H 68" flexible stainless steel hose
- Hook nozzle spray valve (002851-40)
- Hold-down ring for continuous flow of water

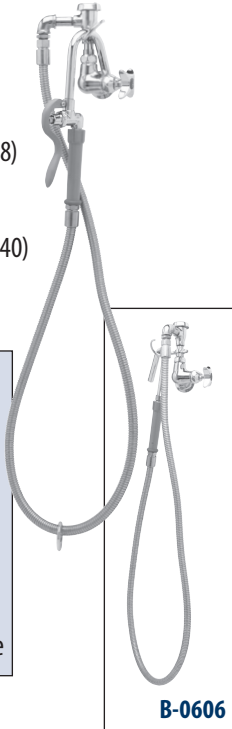

- B-0605-CR** Same as B-0605 except with Cerama cartridges
- B-0605-CR-EK** Same as B-0605-CR except with a supply nipple and short EI with 1/2" NPT female inlet
- B-0606** Same as B-0605 except without (002851-40) spray valve; hook nozzle attaches directly to end of hose

B-0610 Pot and Kettle Filler

- 8" (203 mm) wall mount mixing faucet
- Lever handles with color coded indexes
- 1/2" NPT female eccentric flanged inlets (00AA)
- Vacuum breaker (B-0968)
- B-0068-H 68" flexible stainless steel hose
- Hook nozzle self-closing spray valve (002851-40)
- Hold-down ring for continuous flow of water
- Quarter-turn Eterna cartridges with crossflow prevention

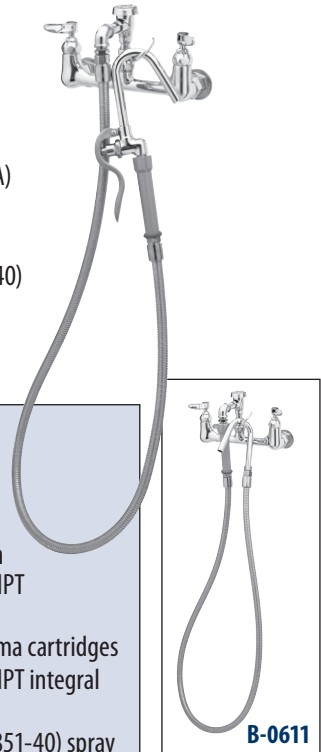

- B-0610-36H** Same as B-0610 except with B-0036-H 36" flexible stainless steel hose
- B-0610-60H** Same as B-0610 except with B-0060-H 60" flexible stainless steel hose
- B-0610-CC-H108** Same as B-0610 except with 108" flexible stainless steel hose and 1/2" NPT male inlet flanges (00CC)
- B-0610-CR** Same as B-0610 except with Cerama cartridges
- B-0610-JJ** Same as B-0610 except with 1/2" NPT integral loose key stop inlets (00JJ)
- B-0611** Same as B-0610 except without (002851-40) spray valve; hook nozzle attaches directly to end of hose (right)
- B-0612** Same as B-0610 except with quarter-turn Cerama cartridges

B 16

Kettle Kaddy Spray Stanchions

All models:

- Are free standing kettle fillers and rinsers
- Easy to clean – sturdy – versatile
- For large floor mounted steam jacketed and self-contained kettles
- Base flange with three bolts holds units firmly to floor (expansion anchors included)
- Serve one to three kettles
- All piping concealed
- Easy to install
- Any length hose furnished upon request

B-0180 Combination Kettle Filler and Spray Stanchion

- 18" (457 mm) double-joint nozzle (002848-40)
- Heat-resistant on-off control grip on tip of nozzle end (035A)
- B-0104-H 104" flexible stainless steel hose
- Angled spray valve (EB-0107-35)
- Tee swivels
- Hook attachment for hanging hose when not in use (002856-40)
- 1/2" NPT connection
- Single water service
- Chrome plated stanchion
- 49" (1245 mm) overall height



- B-0182** Same as B-0180 except with hot and cold valves and 1/2" check valves (2)

B-0180 Kettle Kaddy Explosion

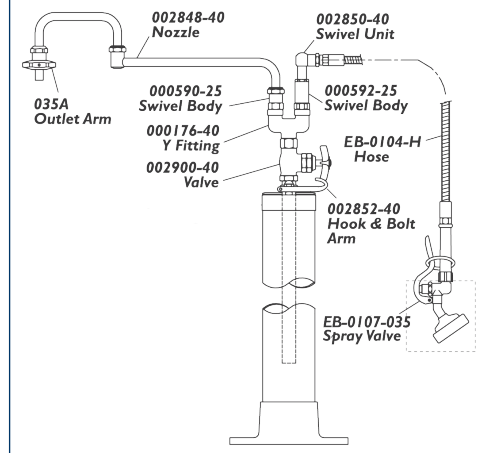

Check Valve for B-0180

B-CVH1-2 for horizontal or vertical use, 1/2" NPT female

Kettle Kaddies / Pot and Kettle Fillers

B-0190 Combination Kettle Filler and Spray Stanchion

- EB-0068-H 68" flexible stainless steel hose with hook nozzle spray valve (012952-40)
- EB-0104-H 104" flexible stainless steel hose
- Angled spray valve (EB-0107-35)
- Chrome plated stanchion
- Swivel tee
- Hook attachment for hanging hose when not in use (002852-40)
- 1/2" NPT connection
- Single water service
- 44" (1118 mm) overall height

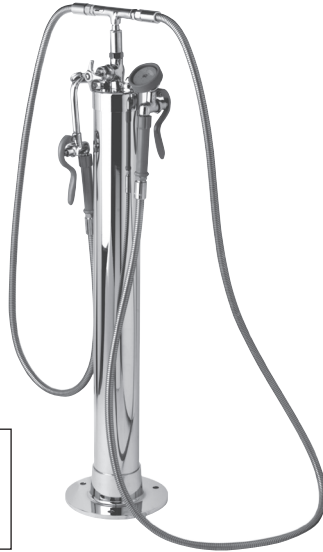

Check Valve for B-0192, B-0193

B-CVH1-2 for horizontal or vertical use, 1/2" NPT female

- B-0192** Same as B-0190 except both hot and cold valves
- B-0193** Same as B-0192 except with in-line vacuum breakers (B-0970-01) at swivel tee ends
- B-0196** Same as B-0190 except with a continuous pressure vacuum breaker (B-0970-01) at hose connection

B-2312 Pot Filler with Quick-Disconnect

- 8" (203 mm) wall mount mixing faucet
- Lever handles with color coded indexes
- 1/2" NPT female eccentric flanged inlets (00AA)
- Vacuum breaker (B-0968)
- B-0044-H 44" flexible stainless steel hose
- Quick-disconnect spray valve with EB-1421, B-1422 and B-1424 quick-disconnect spray heads
- Hold down ring for continuous flow of water
- Eterna cartridges with integral spring checks to prevent crossflow of water



B-0195 Kettle Filler Hose Stanchion

- Hook nozzle spray valve (012952-40)
- EB-0068-H 68" (1727 mm) flexible stainless steel hose
- Hook attachment for hanging hose when not in use (002852-40)
- Single water service
- 1/2" NPT connection
- 44" (1118 mm) overall height



B-0187 Same as B-0195 except with hot and cold valves and 1/2" check valves (2)

B-0188 Same as B-0187 except with a continuous pressure vacuum breaker (B-0970-01) at hose connection

B-2331 Combination Pot Filler and Spray Assemblies

- 8" (203 mm) wall mount mixing faucet
- Lever handles with color coded indexes
- 1/2" NPT female eccentric flanged inlets (00AA)
- Two in-line vacuum breakers (B-0970-FE)
- Two wall hooks (B-0166)
- Two EB-0144-H 144" flexible stainless steel hoses
- EB-0107-035 angled spray valve (1.42 GPM)
- Hook nozzle spray valve (012952-40)
- Swivel tee
- Quarter-turn Eterna cartridges with crossflow prevention

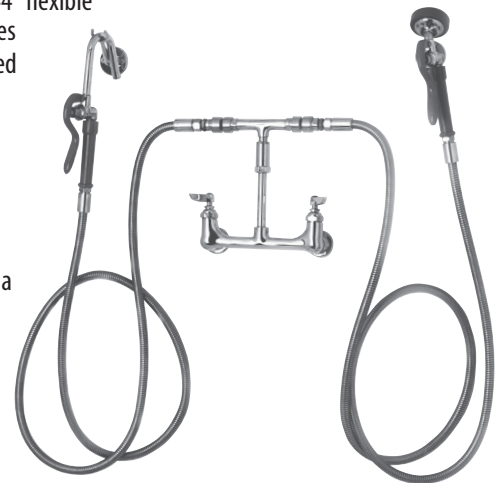

Big-Flo Add-On Faucets and Faucets for Pot Sinks and Kettles

B-0286-LNEZ Big-Flo EasyInstall Add-On Faucet Assembly

- For use with B-0290 Big-Flo series faucets
- 3/8" NPT female pre-rinse unit connection
- 6-1/4" tall x 5-3/8" deep
- Four-arm handle (002521-45)
- Furnished with serrated lock washer for non-swivel installation in base faucet
- Outlet accepts Big-Flo swing nozzles



B-0287 Big-Flo Pre-Rinse with Add-On Faucet

- EasyInstall 8" (203 mm) wall mount Big-Flo mixing faucet with integral check valves (002840-40CV)
- Four-arm handles with color coded indexes
- EasyInstall B-0286-LNEZ add-on faucet with 12" (305 mm) swing nozzle (114X)
- 3/8" NPT 18" riser (000369-40)
- B-0044-H 44" stainless steel hose
- B-0107 spray valve (1.42 GPM)
- 3/4" NPT short elbows (00LL)
- 3/4" NPT female eccentric flanged inlets (00BB)

B-0287-427-B Same as B-0287 except with B-0427 inlet supply nipples and 6" (152 mm) wall bracket (B-0109-01)

Easy Install



**B
18**

Big-Flo Faucets for Pot Sinks and Kettles

Note: Aerators are not available on Big-Flo series faucets

B-0289 Big-Flo Faucet

Easy Install

- EasyInstall 8" (203 mm) wall mount Big-Flo faucet with integral check valves (002840-40CV)
- Big-Flo cartridges (006482-40NS)
- EasyInstall Big-Flo add-on faucet (B-0286-LNEZ) with 18" (457 mm) Big-Flo swing nozzle (115X)
- 034A swivel adapter
- B-0104-H 104" flexible stainless steel hose
- B-0107-035 angled spray valve (1.15 GPM)
- 3/4" NPT female eccentric flanged inlets (00BB)
- 3/4" NPT short elbows (00LL) included
- Finger hook (004R)

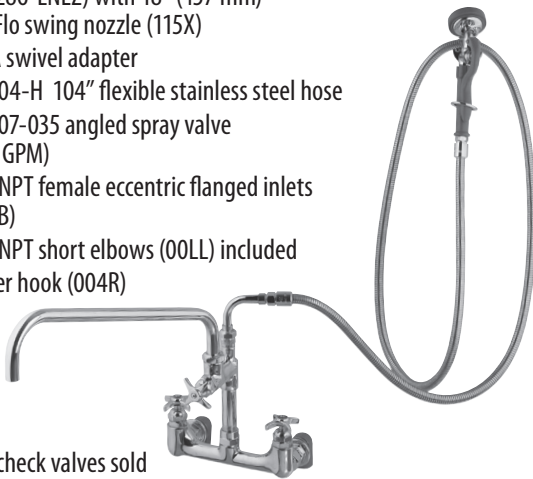

Note: check valves sold separately – B-CVV3-4

B-0284 Same as B-0289 except with 12" (305 mm) swing nozzle (114X)

B-0290 Big-Flo Faucet

- 8" (203 mm) wall mount Big-Flo mixing faucet
- Big-Flo cartridges (006482-40NS)
- 3/4" NPT short elbows (00LL)
- 12" (305 mm) Big-Flo swing nozzle (114X)
- Four-arm handles (002521-45NS) with color coded indexes
- 1-1/4" (32 mm) diameter holes required in backsplash
- 3/4" NPT female eccentric flanged inlets (00BB)



B-0290-04



B-0290-01 Same as B-0290 except with 16" Big-Flo swing nozzle (015297-40) and lever handle

B-0290-04 Same as B-0290 except with 4" wrist-action handles with color coded indexes (inset, left)

B-0290-14 Same as B-0290 except with 14" (356 mm) Big-Flo swing nozzle

B-0290-LN Same as B-0290 except less nozzle

B-0291 Same as B-0290 except with 18" (457 mm) Big-Flo swing nozzle (115X)

B-0292 Same as B-0290 except with 24" (610 mm) double-joint swing nozzle (116X)

Big-Flo Faucets for Pot Sinks and Kettles

Big-Flo Straight Swivel Extensions

BF-0400, BF-0401, BF-0402

Straight Swivel Extension	Length
BF-0400	7-3/8"
BF-0401	4-3/8"
BF-0402	17-3/8"

Straight Swivel Extensions with Gaskets

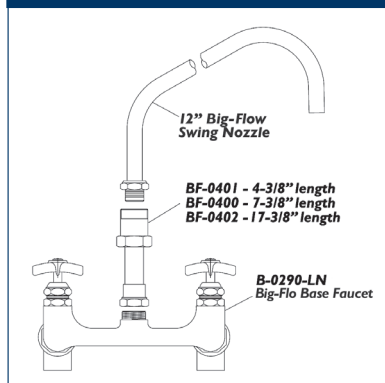

B-0290-PRISON Big-Flo Faucet

- 8" (203 mm) wall mount Big-Flo mixing faucet
- Big-Flo cartridges (006481-40NS)
- 3/4" NPT short elbows (00LL)
- 12" (305 mm) Big-Flo swing nozzle (114X)
- Chrome plated brass lever handles (010027-40) with color coded indexes
- Vandal-resistant handle screws (VRS-1)
- 3/4" NPT female eccentric flanged inlets (00BB)



B-0293 Big-Flo Faucet

- 8" (203 mm) deck mount Big-Flo mixing faucet
- Big-Flo cartridges (006482-40NS)
- 3/4" NPT female flanged elbow inlets (00YY)
- 12" (305 mm) Big-Flo swing nozzle (114X)
- Four-arm handles (002521-45) with color coded indexes



B-0296 Big-Flo Faucet

- Single hole single temperature deck mount Big-Flo faucet
- Big-Flo cartridge (006482-40NS)
- 1/2" NPT female inlet
- Includes B-0425 supply nipple kit
- 12" (305 mm) Big-Flo swing nozzle (114X)
- Four-arm handles (002521-45)
- 8-7/16" (214 mm) clearance



- B-0293-01** Same as B-0293 except with two 3/4" NPT male supply nipple kits (B-0427)
- B-0293-14** Same as B-0293 except with 14" (356 mm) Big-Flo swing nozzle and (2) 3/4" NPT male supply nipple inlet kits (B-0427)
- B-0294** Same as B-0293 except with 18" (457 mm) swing nozzle (115X); 8-7/8" (225 mm) deck to outlet of nozzle
- B-0295** Same as B-0293 except with 24" (610 mm) double joint swing nozzle (116X); 9-1/8" (232 mm) from deck to outlet of nozzle

- B-0296-LN** Same as B-0296 except less nozzle
- B-0297** Same as B-0296 except with 18" (457 mm) swing nozzle (115X); 10-1/2" (267 mm) clearance (right)
- B-0298** Same as B-0296 except with 24" (610 mm) double joint swing nozzle (116X)

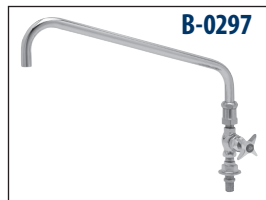

Big-Flo Flow Rates

B-0297, B-0298

Inlet Pressure When Water Is Flowing	Valve Open
20 PSI	5.1 GPM
30 PSI	6.3 GPM
40 PSI	7.3 GPM
50 PSI	8.1 GPM
60 PSI	8.7 GPM

Big-Flo Faucets for Pot Sinks and Kettles

Note: Aerators are not available on Big-Flo series faucets

BF-0299-12 Big-Flo Faucet

- Single hole single temperature wall mount Big-Flo faucet
- 12" (305 mm) plain end swing nozzle (114X)
- Big-Flo cartridge (006482-40NS)
- Four-arm handle (002521-45)
- 2" (51 mm) flange with 3/4" street elbow inlet (00LL)



MODEL	CARTRIDGE	NOZZLE	HEIGHT	CLEARANCE	SPREAD	OUTLET	GPM	HANDLE	NOTES
BF-0299-LN	Big-Flo (006482-40NS)	—	3-9/16" (91 mm)	—	—	—	—	Four-Arm	
BF-0299-06	Big-Flo (006482-40NS)	6" Big-Flo Swing nozzle (BF-0153X)	5-15/16" (150 mm)	1-1/2" (37 mm)	6-1/2" (165 mm)	Plain end	—	Four-Arm	
BF-0299-08	Big-Flo (006482-40NS)	8" Big-Flo Swing nozzle (110X)	7-1/16" (179 mm)	3-3/8" (86 mm)	8" (203 mm)	Plain end	—	Four-Arm	
BF-0299-10	Big-Flo (006482-40NS)	10" Big-Flo Swing nozzle (112X)	7-11/16" (195 mm)	4" (102 mm)	10" (254 mm)	Plain end	—	Four-Arm	
BF-0299-12	Big-Flo (006482-40NS)	12" Big-Flo Swing nozzle (114X)	8-3/8" (213 mm)	4-3/4" (120 mm)	12" (305 mm)	Plain end	—	Four-Arm	
BF-0299-14	Big-Flo (006482-40NS)	14" Big-Flo Swing nozzle (014462-40)	9-1/16" (230 mm)	5-7/16" (137 mm)	14" (356 mm)	Plain end	—	Four-Arm	
BF-0299-16	Big-Flo (006482-40NS)	16" Big-Flo Swing nozzle (015297-40)	9-3/4" (248 mm)	6-1/8" (155 mm)	16" (406 mm)	Plain end	—	Four-Arm	
BF-0299-18	Big-Flo (006482-40NS)	18" Big-Flo Swing nozzle (115X)	10-7/16" (265 mm)	6-13/16" (172 mm)	18" (457 mm)	Plain end	—	Four-Arm	
BF-0299-18DJ	Big-Flo (006482-40NS)	18" Double-joint Big-Flo Swing nozzle (BF-0178A)	12-1/16" (306 mm)	7-5/8" (193 mm)	18-1/2" (470 mm)	Plain end	—	Four-Arm	12" back section, 6-1/2" front section
BF-0299-24DJ	Big-Flo (006482-40NS)	24" Double-joint Big-Flo Swing nozzle (116X)	12" (305 mm)	7-9/16" (192 mm)	24" (610 mm)	Plain end	—	Four-Arm	12" back section, 12" front section

BF-0176 Big-Flo Faucet

- Single hole single temperature deck mount Big-Flo faucet
- Big-Flo cartridge (006482-40NS)
- 12" (305 mm) swing nozzle (114X)
- EB-0060-H 60" (1524 mm) flexible stainless steel hose
- EB-0107-035 angled spray valve
- Finger hook (004R)





RELIABILITY BUILT IN™

G-12

 *Faucets and Components*



G-12 General Product Catalog

Table of Contents



RELIABILITY BUILT IN™

Faucets and Components – C

T&S PRODUCTS featured:

- Updated design of nozzles, goosenecks, cartridges, bonnets, handles and indexes
- B-1100 Series Workboard Faucets: now feature T&S Eterna cartridges, redesigned bodies, bonnets, handles

T&S Product Adaptability C3

Deck Mount and Wall Mount Single and Dual Temp Faucets C4-24

Swivel/Rigid Single and Double Pantry Base Faucets

- -LN Faucets and Nozzles, Goosenecks and Spout Options C4
- Deck Mount Dual Temp Faucets C5, 6, 12-16
- Deck Mount Single Temp Faucets C7-9
- Wall Mount Dual Temp Faucets C17-21
- Wall Mount Single Temp Faucets C10-11
- Other Wall Mount Dual Temp Faucets C24

Workboard Faucets and Nozzles C26-41

- Deck Mount Faucets, 4" and 8" C26, 28-29, 32-33, 37-38, 40-41
- Wall Mount Faucets, 4" and 8" C27, 30-31, 34-36, and 39

Elevated Vacuum Breaker Assemblies C37

Waste Valves and Accessories C42-48

- Twist, Lever and Specialty models, Parts and Accessories C42-45
- Modular Waste Valve models, Parts and Accessories C46-48

TIP

- Find this section's Parts and Repair Kits in the **G-12 Parts Kits** section (G).
- Find Nozzles, Aerators and other accessories for the models in this section in the **G-12 Accessories** section (ACS).

NOTE:
A comprehensive Index By Model or Part Number and Page can be found in the G-12 General Product Catalog Master Index section (IN).

? Can't find the T&S product you're looking for? Please visit www.tsbrass.com for a complete product listing.

Product Adaptability

T&S Brass offers unparalleled product adaptability! Our base faucets, nozzles, aerators, goosenecks, spouts, handles and inlet options mean many combinations of T&S components are available as models or modifications. See our *"Swivel/Rigid Single and Double Pantry Base Faucets"* and *"Nozzles, Goosenecks and Spout Options"* Chart on page C4.

T&S handles, inlets, nozzles, goosenecks, spouts and a comprehensive line of standard and water-saving outlets shown in this section are fully detailed in the *Accessories section* in the G-12 Catalog.

Nozzles, Goosenecks and Spouts

Handles

Inlets

T&S Swivel or Rigid Faucets can combine with a wide variety of Goosenecks, Nozzles, Spouts, Handles and Inlets

Look for Nozzles, Aerators, Goosenecks and Handles in our G-12 Accessories section (ACS)

Outlets

Single and Double Pantry Base Faucets (-LN Models) Nozzles, Goosenecks and Spout Options

Nozzles, Goosenecks and Spout Options

• A selection of T&S swing nozzles, swivel goosenecks and spouts found on many T&S models

Swing Nozzle

• With B-PT stream regulator outlet

059X 6" (152 mm)



060X 8" (203 mm)

061X 10" (254 mm)

062X 12" (305 mm)

065X 18" (457mm)

Double-Joint Nozzle

• With B-PT stream regulator outlet

066X 12" (305 mm)



067X 15" (381 mm)

068X 18" (457 mm)

Cast Nozzle

• With 2.2 GPM aerator (B-0199-02)

OCS6 6" (152 mm)



Swivel Gooseneck

• With B-PT stream regulator outlet

133X 5-3/4" (146 mm)



B-0200-LN Deck Mixing Faucet

- Single hole deck mount mixing faucet
- Lever handles
- 18" flexible inlet hoses (compression fittings for 5/8" O.D. tubing or 1/2" NPSM male thread)
- 1-1/8" (25 mm) dia. shank



B-0205-LN Deck Single Temperature Faucet

- Single hole, single temperature deck mount faucet
- Lever handle with blue index (cold)
- 1/2" NPSM shank
- Furnished with 1/4" NPT tailpiece (150A)



B-0220-LN Deck Mixing Faucet

- 8" deck mount mixing faucet
- Lever handles
- 1/2" NPT female eccentric flanged female inlets (00AA)



B-0225-LN Deck Mixing Faucet

- 4" deck mount mixing faucet
- Lever handles
- 1/2" NPT female eccentric flanged female inlets (00AA)



B-0230-LN Wall Mixing Faucet

- 8" wall mount mixing faucet
- Lever handles
- 1/2" NPT female eccentric flanged female inlets (00AA)



B-0235-LN Wall Mixing Faucet

- Wall mount mixing faucet
- Lever handles
- 1/2" NPT female adjustable inlet arm flanges (00GG)
- 2-1/4" (57 mm) to 8-1/4" (210 mm) centers



B-0210-LN Wall Single Temperature Faucet

- Single hole, single temperature wall mount faucet
- Four-arm handle with blue index (cold)
- 1/2" NPT female flanged inlet



B-0240-LN Wall Mixing Faucet

- Wall mount mixing faucet
- Lever handles
- 2-1/4" (57 mm) to 8-1/4" (210 mm) centers adjustable inlet arms (00XX)
- 1/2" NPT female flanged inlets
- Integral screwdriver stops



B-0200 Series Double Pantry Faucets

- Single hole deck mount mixing faucet
- Swivel/rigid swing nozzle
- Cartridges with cross flow prevention
- Lever handles with color coded indexes
- 1-1/8" (29 mm) dia. shank
- Fits sink up to 1-3/8" (35 mm) thick
- 18" flexible inlet hoses (compression fittings for 5/8" O.D. tubing or 1/2" NPSM male thread)

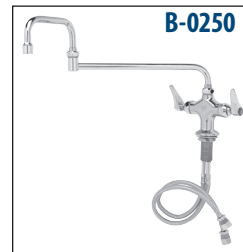

MODEL	1/4-Turn CARTRIDGE w/ Cross Flow Prevention	NOZZLE	HEIGHT	CLEARANCE	SPREAD	OUTLET	GPM	HANDLE	VR	NOTES
B-0200	Eterna	18" swivel/rigid nozzle (065X)	12-1/4" (311 mm)	9-1/8" (231 mm)	18" (458 mm)	B-PT Stream Regulator	—	Lever	N	
B-0200-CR	Cerama	18" swivel/rigid nozzle (065X)	12-1/4" (311 mm)	9-1/8" (231 mm)	18" (458 mm)	B-PT Stream Regulator	—	Lever	N	
B-0200-CR-LN	Cerama	—	4" (102 mm)	—	—	—	—	Lever	N	Less nozzle
B-0200-LN	Eterna	—	4" (102 mm)	—	—	—	—	Lever	N	Less nozzle
B-0200-LNM	Eterna	—	4" (102 mm)	—	—	—	—	Lever	N	-LN Master carton of 6
B-0200-M	Eterna	18" swivel/rigid nozzle (065X)	12-1/4" (311 mm)	9-1/8" (231 mm)	18" (458 mm)	B-PT Stream Regulator	—	Lever	N	B-0200 Master carton of 6
B-0200-44H-VB	Eterna	90° swivel arm (034A)	3-15/16" (99 mm)	—	—	B-0107-035 Angled Spray Valve	1.15 GPM	Lever	N	44" stainless steel flex hose; B-0970-01 continuous pressure vacuum breaker; wall hook
B-0200-60H-VB	Eterna	90° swivel arm (034A)	3-15/16" (99 mm)	—	—	B-0107-035 Angled Spray Valve	1.15 GPM	Lever	N	60" stainless steel flex hose; B-0970-01 continuous pressure vacuum breaker; wall hook
B-0201	Eterna	12" swivel/rigid nozzle (062X)	10-3/16" (259 mm)	7-1/16" (180 mm)	12" (305 mm)	B-PT Stream Regulator	—	Lever	N	
B-0201-M	Eterna	12" swivel/rigid nozzle (062X)	10-3/16" (259 mm)	7-1/16" (180 mm)	12" (305 mm)	B-PT Stream Regulator	—	Lever	N	B-0201 Master carton of 6
B-0202	Eterna	6" swivel/rigid nozzle (059X)	8-1/4" (209 mm)	5-1/8" (131 mm)	6" (153 mm)	B-PT Stream Regulator	—	Lever	N	
B-0202-CR	Cerama	6" swivel/rigid nozzle (059X)	8-1/4" (209 mm)	5-1/8" (131 mm)	6" (153 mm)	B-PT Stream Regulator	—	Lever	N	
B-0250	Eterna	18" Dbl.-joint swivel/rigid nozzle (068X)	10-1/4" (260 mm)	7-1/16" (179 mm)	18" (457 mm)	B-PT Stream Regulator	—	Lever	N	
B-0251	Eterna	15" Dbl.-joint swivel/rigid nozzle (067X)	10-1/4" (260 mm)	7-1/16" (179 mm)	15" (382 mm)	B-PT Stream Regulator	—	Lever	N	
B-0252	Eterna	12" Dbl.-joint swivel/rigid nozzle (066X)	10-1/4" (260 mm)	7-1/16" (179 mm)	12" (305 mm)	B-PT Stream Regulator	—	Lever	N	

VR Vandal-resistant



B-0300 Series Double Pantry Faucets

- Single hole deck mount mixing faucet
- Swivel/rigid gooseneck
- Quarter-turn cartridges with cross flow prevention
- 1-1/8" (29 mm) dia. shank
- Fits sink up to 1-3/8" (35 mm) thick
- 18" flexible inlet hoses (compression fittings for 5/8" O.D. tubing or 1/2" NPSM male thread)



MODEL	1/4-Turn CARTRIDGE w/ Cross Flow Prevention	GOOSENECK	HEIGHT	CLEARANCE	SPREAD	OUTLET	GPM	HANDLE	VR	NOTES
B-0300	Eterna	5-3/4" swivel/rigid gooseneck (133X)	13-1/2" (343 mm)	9-1/16" (230 mm)	5-3/4" (145 mm)	B-PT Stream Regulator	—	Lever	N	
B-0300-CR	Cerama	5-3/4" swivel/rigid gooseneck (133X)	13-1/2" (343 mm)	9-1/16" (230 mm)	5-3/4" (145 mm)	B-PT Stream Regulator	—	Lever	N	
B-0300-LN	Eterna	—	3-7/8" (99 mm)	—	—	—	—	Lever	N	Less gooseneck
B-0300-VR	Eterna	5-3/4" swivel/rigid gooseneck (133X-V22)	13-1/2" (343 mm)	9-1/16" (230 mm)	5-3/4" (145 mm)	B-0199-06 VR aerator	2.2 GPM	Lever	Y	Includes anti-rotation base screws; VR handle screws; VR key
B-0300-VR4	Eterna	5-3/4" swivel/rigid gooseneck (133X-V22)	13-1/2" (343 mm)	9-1/16" (230 mm)	5-3/4" (145 mm)	B-0199-06 VR aerator	2.2 GPM	4" Wrist-action	Y	Includes anti-rotation base screws; VR handle screws; VR key
B-0300-WH4	Eterna	5-3/4" swivel/rigid gooseneck (133X)	13-1/2" (343 mm)	9-1/16" (230 mm)	5-3/4" (145 mm)	B-PT Stream Regulator	—	4" Wrist-action	N	
B-0301-01	Eterna	5-3/4" swivel/rigid gooseneck (133X-A22)	13-1/2" (343 mm)	9-1/16" (230 mm)	5-3/4" (145 mm)	B-0199-01 aerator	2.2 GPM	Lever	N	
B-0301-01QT-WS	Eterna	5-3/4" swivel/rigid gooseneck (133X)	13-1/2" (343 mm)	9-1/16" (230 mm)	5-3/4" (145 mm)	B-0199-06-WS VR aerator	1.5 GPM	Lever	Y	
B-0301-VR	Eterna	5-3/4" swivel/rigid gooseneck (133X-V22)	13-1/2" (343 mm)	9-1/16" (230 mm)	5-3/4" (145 mm)	B-0199-06 VR aerator	2.2 GPM	Lever	Y	Anti-rotation screws in body; VR lever handle screws; VR keys
B-0301-W4-QT-WS	Eterna	5-3/4" swivel /rigid gooseneck	13-1/2" (343 mm)	9-1/16" (230 mm)	5-3/4" (145 mm)	B-0199-06-WS VR aerator	1.5 GPM	4" Wrist-action	Y	
B-0309	Eterna	8-13/16" swivel/rigid gooseneck (135X-V22)	15-3/16" (386 mm)	8-5/16" (211 mm)	8-13/16" (223 mm)	B-0199-07 VR Aerator	2.2 GPM	4" Wrist-action	Y	Anti-rotation screws in body; VR lever handle screws; VR keys
B-0314	Eterna	8-13/16" swivel/rigid gooseneck	15-3/16" (386 mm)	8-5/16" (211 mm)	8-13/16" (223 mm)	B-0199-07 VR Aerator	2.2 GPM	Lever	Y	Anti-rotation screws in body; VR lever handle screws; VR keys

VR Vandal-resistant

C
6

Find Nozzles, Aerators, Goosenecks and Handles in our G-12 Accessories section (ACS)



B-0205 Series Single Pantry Faucet

- Single hole, single temperature deck mount faucet
- Swivel/rigid swing nozzle
- Quarter-turn cartridge
- Lever handle with blue (cold) color coded index
- 1/2" NPSM male inlet
- Includes (150A) tailpiece and nut for 1/4" NPT connection



MODEL	1/4-Turn CARTRIDGE	NOZZLE	HEIGHT	CLEARANCE	SPREAD	OUTLET	GPM	HANDLE	VR	NOTES
B-0205	Eterna	18" swivel/rigid nozzle (065X)	12-3/4" (324 mm)	9-9/16" (243 mm)	18" (457 mm)	B-PT Stream Regulator	—	Lever	N	
B-0205-060X-CR	Cerama	8" swivel/rigid nozzle (060X)	9-5/16" (237 mm)	6-3/16" (157 mm)	8" (203 mm)	B-PT Stream Regulator	—	Lever	N	
B-0205-061X-CR	Cerama	10" swivel/rigid nozzle (061X)	10-1/16" (255 mm)	6-7/8" (175 mm)	10" (254 mm)	B-PT Stream Regulator	—	Lever	N	
B-0205-CR-LN	Cerama	—	4-3/8" (111 mm)	—	—	—	—	Lever	N	Less nozzle
B-0205-LN	Eterna	—	4-3/8" (111 mm)	—	—	—	—	Lever	N	Less nozzle
B-0205-LNM	Eterna	—	4-3/8" (111 mm)	—	—	—	—	Lever	N	-LN Master carton of 6
B-0205-M	Eterna	18" swivel/rigid nozzle (065X)	12-3/4" (324 mm)	9-9/16" (243 mm)	18" (457 mm)	B-PT Stream Regulator	—	Lever	N	Master carton of 6
B-0205-44H-VB	Eterna	90° swivel arm (034A)	6-11/16" (169 mm)	—	—	B-0107-035 Angled spray valve	1.15 GPM	Lever	N	44" stainless steel flex hose; B-0970-01 continuous pressure vacuum breaker; wall hook
B-0205-60H-VB	Eterna	90° swivel arm (034A)	6-11/16" (169 mm)	—	—	B-0107-035 Angled spray valve	1.15 GPM	Lever	N	68" stainless steel flex hose; B-0970-01 continuous pressure vacuum breaker; wall hook
B-0206	Eterna	12" swivel/rigid nozzle (062X)	10-11/16" (271 mm)	7-9/16" (192 mm)	12" (305 mm)	B-PT Stream Regulator	—	Lever	N	
B-0206-01	Eterna	12" swivel/rigid nozzle (062X)	14-13/16" (375 mm)	11-5/8" (296 mm)	12" (305 mm)	B-PT Stream Regulator	—	Lever	N	4-5/8" straight swivel extension
B-0206-02	Eterna	12" swivel/rigid nozzle (062X)	17-3/4" (452 mm)	14-5/8" (372 mm)	12" (305 mm)	B-PT Stream Regulator	—	Lever	N	7-5/8" straight swivel extension
B-0206-02-CR	Cerama	12" swivel/rigid nozzle (062X)	17-3/4" (452 mm)	14-5/8" (372 mm)	12" (305 mm)	B-PT Stream Regulator	—	Lever	N	7-5/8" straight swivel extension
B-0206-CR	Cerama	12" swivel/rigid nozzle (062X)	10-11/16" (271 mm)	7-9/16" (192 mm)	12" (305 mm)	B-PT Stream Regulator	—	Lever	N	
B-0206-M	Eterna	12" swivel/rigid nozzle (062X)	10-11/16" (271 mm)	7-15/16" (202 mm)	12" (305 mm)	B-PT Stream Regulator	—	Lever	N	Master carton of 6
B-0207	Eterna	6" swivel/rigid nozzle (059X)	8-11/16" (221 mm)	5-5/8" (143 mm)	6" (152 mm)	B-PT Stream Regulator	—	Lever	N	

VR Vandal-resistant



B-0305 Series Single Pantry Faucet

- Single hole, single temperature deck mount faucet
- Swivel/rigid gooseneck
- Quarter-turn cartridge
- Lever handle with blue (cold) color coded index
- 1/2" NPSM male shank
- Includes (150A) tailpieces and nuts for 1/4" NPT connections



B-0305



B-0305-VR4-WS

MODEL	1/4-Turn CARTRIDGE	GOOSENECK	HEIGHT	CLEARANCE	SPREAD	OUTLET	GPM	HANDLE	VR	NOTES
B-0304	Eterna	Swivel/rigid gooseneck	15-11/16" (398 mm)	8-3/4" (222 mm)	8-13/16" (223 mm)	B-0199-07 VR Aerator	2.2 GPM	Lever	Y	VR lever handle; VR aerator
B-0305	Eterna	5-3/4" swivel/rigid gooseneck (133X)	14" (355 mm)	9-9/16" (243 mm)	5-3/4" (145 mm)	B-PT Stream Regulator	—	Lever	N	
B-0305-LN	Eterna	—	4-3/8" (111 mm)	—	—	—	—	Lever	N	Less gooseneck
B-0305-VR	Eterna	5-3/4" swivel/rigid gooseneck (133X-V22)	14" (355 mm)	9-1/2" (242 mm)	5-3/4" (145 mm)	B-0199-06 VR aerator	2.2 GPM	Lever	Y	Includes anti-rotation base screws; VR handle screw; VR aerator key
B-0305-VR4	Eterna	5-3/4" swivel/rigid gooseneck (133X-V22)	14" (355 mm)	9-1/2" (242 mm)	5-3/4" (145 mm)	B-0199-06 VR aerator	2.2 GPM	4" Wrist-action	Y	Includes anti-rotation base screws; VR handle screw; VR aerator key
B-0305-01	Eterna	5-3/4" swivel/rigid gooseneck (133X-A22)	14" (355 mm)	9-1/2" (242 mm)	5-3/4" (145 mm)	B-0199-01 aerator	2.2 GPM	Lever	N	
B-0305-03	VR Self-closing metering	5-3/4" swivel/rigid gooseneck (133X-V22)	14" (355 mm)	9-1/2" (242 mm)	5-3/4" (145 mm)	B-0199-06 VR aerator	2.2 GPM	Lever	Y	Includes anti-rotation base screws; VR handle screw; VR aerator key
B-0305-CR	Cerama	5-3/4" swivel/rigid gooseneck (133X)	14" (355 mm)	9-1/2" (242 mm)	5-3/4" (145 mm)	B-PT Stream Regulator	—	Lever	N	
B-0305-LN-175F	Eterna	—	4-3/8" (111 mm)	—	—	—	—	Four-arm	N	Less nozzle
B-0305-QT-WS	Eterna	5-3/4" swivel/rigid gooseneck (135X-A15)	14" (355 mm)	9-1/2" (242 mm)	5-3/4" (145 mm)	B-0199-01-WS aerator	1.5 GPM	Lever	N	
B-0305-TL	Eterna	5-3/4" swivel/rigid gooseneck	14" (355 mm)	9-9/16" (242 mm)	5-3/4" (145 mm)	B-PT Stream Regulator	—	Lever (cold index)	N	Tin-lined faucet
B-0305-VF22	Eterna	5-3/4" swivel/rigid gooseneck (133X-V22)	14" (355 mm)	9-1/2" (242 mm)	5-3/4" (145 mm)	B-0199-07 VR aerator	2.2 GPM	Lever	Y	VR handle screw; VR aerator key
B-0305-VR4-WS	Eterna	5-3/4" swivel/rigid gooseneck	14" (355 mm)	9-1/2" (242 mm)	5-3/4" (145 mm)	B-0199-06-WS VR aerator	1.5 GPM	4" Wrist-action	Y	Includes anti-rotation base screws; VR handle screw
B-0308-04	Eterna	5-3/4" swivel/rigid gooseneck (133X-A22)	14" (355 mm)	9-1/2" (242 mm)	5-3/4" (145 mm)	B-0199-01 aerator	2.2 GPM	4" Wrist-action	N	
B-0308-04QT-WS	Eterna	5-3/4" swivel/rigid gooseneck	14" (355 mm)	9-1/2" (242 mm)	5-3/4" (145 mm)	B-0199-06-WS VR aerator	1.5 GPM	4" Wrist-action	Y	
B-0308-CR-VRS	Cerama	5-3/4" swivel/rigid gooseneck	14" (355 mm)	9-1/2" (242 mm)	5-3/4" (145 mm)	B-0199-06 VR aerator	2.2 GPM	Lever	Y	VR handle screw; VR aerator key
B-0308-QT-VWS	Eterna	5-3/4" swivel/rigid gooseneck	14" (355 mm)	9-1/2" (242 mm)	5-3/4" (145 mm)	B-0199-06-WS VR aerator	1.5 GPM	Lever	Y	VR handle screw; VR aerator key
B-0308-QT-WS	Eterna	5-3/4" swivel/rigid gooseneck (133X-A15)	14" (355 mm)	9-1/2" (242 mm)	5-3/4" (145 mm)	B-0199-01-WS aerator	1.5 GPM	Lever	N	



B-0210 Series Single Pantry Faucet

- Single hole, single temperature wall mount faucet
- Swing/rigid nozzle
- Quarter-turn cartridge
- Four-arm handle with blue (cold) color coded index
- 2" (51 mm) diameter flange with 1/2" NPT female inlet



B-0216-177F



B-0260-CR-177F



MODEL	1/4-Turn CARTRIDGE	NOZZLE	HEIGHT	CLEARANCE	SPREAD	OUTLET	GPM	HANDLE	VR	NOTES
B-0210	Eterna	18" swivel/rigid nozzle (065X)	10" (254 mm)	6-7/8" (174 mm)	18" (457 mm)	B-PT Stream Regulator	—	Four-arm	N	
B-0210-060X	Eterna	8" swivel/rigid nozzle (060X)	6-9/16" (167 mm)	3-7/16" (88 mm)	8" (203 mm)	B-PT Stream Regulator	—	Four-arm	N	
B-0210-LN	Eterna	—	1-5/8" (42 mm)	—	—	—	—	Four-arm	N	Less nozzle
B-0210-LNM	Eterna	—	1-5/8" (42 mm)	—	—	—	—	Four-arm	N	-LN Master carton of 6
B-0211	Eterna	12" swivel/rigid nozzle (062X)	7-15/16" (202 mm)	4-13/16" (123 mm)	12" (305 mm)	B-PT Stream Regulator	—	Four-arm	N	
B-0212	Eterna	6" swivel/rigid nozzle (059X)	6" (152 mm)	2-7/8" (73 mm)	6" (152 mm)	B-PT Stream Regulator	—	Four-arm	N	
B-0212-F05	Eterna	6" swivel/rigid nozzle	6" (152 mm)	2-13/16" (72 mm)	6" (153 mm)	B-0199-01-N05 Non-aerated spray device	0.5 GPM	Four-arm	N	
B-0216	Eterna	6" Cast Spout (0CS6)	3-1/4" (82 mm)	1-5/8" (41 mm)	6" (152 mm)	B-0199-02 Aerator	2.2 GPM	Four-arm	N	
B-0216-CR	Cerama	6" Cast Spout (0CS6)	3-1/4" (82 mm)	1-5/8" (41 mm)	6" (152 mm)	B-0199-02 Aerator	2.2 GPM	Four-arm	N	
B-0216-177F	Eterna	6" Cast Spout (0CS6)	3-1/4" (82 mm)	1-5/8" (41 mm)	6" (152 mm)	B-0199-02 Aerator	2.2 GPM	Lever	N	
B-0260	Eterna	18" double-joint swivel/rigid nozzle (068X)	8" (203 mm)	4-13/16" (122 mm)	18" (457 mm)	B-PT Stream Regulator	—	Four-arm	N	
B-0260-CR-177F	Cerama	18" double-joint swivel/rigid nozzle (068X)	8" (203 mm)	4-13/16" (122 mm)	18" (457 mm)	B-PT Stream Regulator	—	Lever	N	
B-0261	Eterna	15" double-joint swivel/rigid nozzle (067X)	8" (203 mm)	4-13/16" (122 mm)	15" (381 mm)	B-PT Stream Regulator	—	Four-arm	N	
B-0262	Eterna	12" double-joint swivel/rigid nozzle (065X)	8" (203 mm)	4-13/16" (122 mm)	12" (305 mm)	B-PT Stream Regulator	—	Four-arm	N	

VR Vandal-resistant



B-0220 Series Double Pantry Faucet



- 8" (203 mm) deck mount mixing faucet
- Swing/rigid nozzle
- Quarter-turn cartridges with cross flow prevention
- Lever handles with color coded indexes
- 1/2" NPT female inlets

MODEL	1/4-Turn CARTRIDGE w/ Cross Flow Prevention	NOZZLE	HEIGHT	CLEARANCE	SPREAD	OUTLET	GPM	HANDLE	VR	NOTES
B-0220	Eterna	18" swivel/rigid nozzle (065X)	12" (305 mm)	8-7/8" (225 mm)	18" (457 mm)	B-PT Stream regulator	—	Lever	N	
B-0220-060X	Eterna	8" swivel/rigid nozzle (060X)	8-5/8" (219 mm)	5-1/2" (139 mm)	8" (203 mm)	B-PT Stream regulator	—	Lever	N	
B-0220-061X	Cerama	10" swivel/rigid nozzle (061X)	9-1/4" (235 mm)	6-1/8" (156 mm)	10" (254 mm)	B-PT Stream regulator	—	Lever	N	
B-0220-61X-CCCR	Cerama	10" swivel/rigid nozzle (061X)	8-15/16" (227 mm)	5-13/16" (147 mm)	10" (254 mm)	B-PT Stream regulator	—	Lever	N	00CC 1/2" NPT male inlets
B-0220-166X-CRK	Cerama	9" swivel/rigid nozzle (166X)	11-1/4" (286 mm)	8-5/16" (211 mm)	9" (229 mm)	B-PT Stream regulator	—	Lever	N	Includes B-0425-M 1/2" NPT male supply nipple kit
B-0220-CC	Eterna	18" swivel/rigid nozzle (065X)	11-5/8" (295 mm)	8-7/16" (215 mm)	18" (458 mm)	B-PT Stream regulator	—	Lever	N	00CC 1/2" NPT male inlets
B-0220-CR	Cerama	18" swivel/rigid nozzle (065X)	12" (305 mm)	8-7/8" (225 mm)	18" (458 mm)	B-PT Stream regulator	—	Lever	N	
B-0220-CR-LN	Cerama	—	5-1/18" (131 mm)	—	—	—	—	Lever	N	
B-0220-EE	Eterna	18" swivel/rigid nozzle (065X)	11-15/16" (303 mm)	8-7/8" (225 mm)	18" (458 mm)	B-PT Stream regulator	—	Lever	N	00EE 1/2" NPT male inlets w/ adj. flange
B-0220-EE-061X	Eterna	10" swivel/rigid nozzle (061X)	9-1/4" (235 mm)	6-1/16" (155 mm)	10" (254 mm)	B-PT Stream regulator	—	Lever	N	00EE 1/2" NPT male inlets w/ adj. flange
B-0220-EELN	Eterna	—	5-1/16" (129 mm)	—	—	—	—	Lever	N	Less nozzle; 00EE 1/2" NPT male inlets w/ adj. flange
B-0220-LN	Eterna	—	5-3/16" (132 mm)	—	—	—	—	Lever	N	Less swing nozzle
B-0220-LNCC	Eterna	—	4-3/4" (121 mm)	—	—	—	—	Lever	N	Less nozzle; 00CC 1/2" NPT male inlets
B-0220-LNCCM	Eterna	—	4-3/4" (121 mm)	—	—	—	—	Lever	N	-LNCC Master carton of 6
B-0220-LNM	Eterna	—	5-3/16" (132 mm)	—	—	—	—	Lever	N	-LN Master carton of 6
B-0220-M	Eterna	18" swivel/rigid nozzle (065X)	12" (305 mm)	8-7/8" (225 mm)	18" (458 mm)	B-PT Stream regulator	—	Lever	N	B-0220 Master carton of 6
B-0221	Eterna	12" swivel/rigid nozzle (062X)	10" (254 mm)	6-3/4" (172 mm)	12" (305 mm)	B-PT Stream regulator	—	Lever	N	
B-0221-CC	Eterna	12" swivel/rigid nozzle (062X)	9-9/16" (243 mm)	6-7/16" (163 mm)	12" (305 mm)	B-PT Stream regulator	—	Lever	N	00CC 1/2" NPT male inlets
B-0221-CC-CR	Cerama	12" swivel/rigid nozzle (062X)	9-9/16" (243 mm)	6-7/16" (163 mm)	12" (305 mm)	B-PT Stream regulator	—	Lever	N	00CC 1/2" NPT male inlets
B-0221-CR	Cerama	12" swivel/rigid nozzle (062X)	10" (253 mm)	6-13/16" (173 mm)	12" (305 mm)	B-PT Stream regulator	—	Lever	N	

VR Vandal-resistant



B-0220 Series Double Pantry Faucet

Chart, cont.



B-0246

MODEL	1/4-Turn CARTRIDGE w/ Cross Flow Prevention	NOZZLE	HEIGHT	CLEARANCE	SPREAD	OUTLET	GPM	HANDLE	VR	NOTES
B-0221-CR4-L22	Cerama	12" swivel/rigid nozzle (062X-L22)	10" (253 mm)	6-7/8" (174 mm)	12" (305 mm)	B-0199-21 Laminar flow device	2.2 GPM	4" Wrist-Action	N	
B-0221-EE	Eterna	12" swivel/rigid nozzle (062X)	9-7/8" (250 mm)	6-3/4" (172 mm)	12" (305 mm)	B-PT Stream regulator	—	Lever	N	00EE 1/2" NPT male inlets w/ adjustable flange
B-0221-KK	Eterna	12" swivel/rigid nozzle (062X)	10-3/8" (263 mm)	7-1/4" (183 mm)	12" (305 mm)	B-PT Stream regulator	—	Lever	N	00KK 1/2" NPT male 45° panel inlet flanges
B-0221-M	Eterna	12" swivel/rigid nozzle (062X)	10" (254 mm)	6-7/8" (174 mm)	12" (305 mm)	B-PT Stream regulator	—	Lever	N	B-0221 Master carton of 6
B-0221-WH4	Eterna	12" swivel/rigid nozzle (062X)	10" (254 mm)	6-7/8" (174 mm)	12" (305 mm)	B-PT Stream regulator	—	4" Wrist-action	N	
B-0222	Eterna	6" swivel/rigid nozzle (059X)	8" (203 mm)	4-7/8" (124 mm)	6" (152 mm)	B-PT Stream regulator	—	Lever	N	
B-0222-CC	Eterna	6" swivel/rigid nozzle (059X)	7-5/8" (193 mm)	4-1/2" (114 mm)	6" (152 mm)	B-PT Stream regulator	—	Lever	N	00CC 1/2" NPT male inlets
B-0222-EE	Eterna	6" swivel/rigid nozzle (059X)	7-15/16" (201 mm)	4-13/16" (122 mm)	6" (152 mm)	B-PT Stream regulator	—	Lever	N	00EE 1/2" NPT male inlets w/ adjustable flange
B-0222-M	Eterna	6" swivel/rigid nozzle (059X)	8" (203 mm)	4-7/8" (124 mm)	6" (152 mm)	B-PT Stream regulator	—	Lever	N	B-0222 Master carton of 6
B-0245	Eterna	18" double-joint swivel/rigid (068X)	10" (254 mm)	6-13/16" (173 mm)	18" (457 mm)	B-PT Stream regulator	—	Lever	N	
B-0246	Eterna	15" double-joint swivel/rigid (067X)	10" (254 mm)	6-13/16" (173 mm)	15" (382 mm)	B-PT Stream regulator	—	Lever	N	
B-0247	Eterna	12" double-joint swivel/rigid (066X)	10" (254 mm)	6-13/16" (173 mm)	12" (305 mm)	B-PT Stream regulator	—	Lever	N	
B-2280	Eterna	12" swivel/rigid nozzle (062X)	10" (254 mm)	6-13/16" (174 mm)	12" (305 mm)	B-PT Stream regulator	—	Lever	N	Includes (2) B-0425 1/2" NPT male supply nipple kits
B-2280-060X	Eterna	8" swivel/rigid nozzle (060X)	8-5/8" (218 mm)	5-7/16" (139 mm)	8" (203 mm)	B-PT Stream regulator	—	Lever	N	
B-2280-CR	Cerama	12" swivel/rigid nozzle (062X)	10" (254 mm)	6-13/16" (174 mm)	12" (305 mm)	B-PT Stream regulator	—	Lever	N	Includes (2) B-0425 1/2" NPT male supply nipple kits

VR Vandal-resistant



B-0320 Series Double Pantry Faucet

- 8" (203 mm) deck mount mixing faucet
- Swivel/rigid gooseneck
- Quarter-turn cartridges with cross flow prevention
- Lever handles with color coded indexes
- 1/2" NPT female inlets



MODEL	1/4-Turn CARTRIDGE w/ Cross Flow Prevention	GOOSENECK	HEIGHT	CLEARANCE	SPREAD	OUTLET	GPM	HANDLE	VR	NOTES
B-0320	Eterna	5-3/4" swivel/rigid gooseneck (133X)	13-1/4" (337 mm)	8-13/16" (224 mm)	5-3/4" (145 mm)	B-PT Stream regulator	—	Lever	N	
B-0320-LN	Eterna	—	5-3/16" (131 mm)	—	—	—	—	Lever	N	Less gooseneck
B-0321-CC	Eterna	5-3/4" swivel/rigid gooseneck (133X)	12-13/16" (326 mm)	8-7/16" (214 mm)	5-3/4" (145 mm)	B-PT Stream regulator	—	Lever	N	00CC 1/2" NPT male inlets
B-0321-CC-CR	Cerama	5-3/4" swivel/rigid gooseneck (133X)	12-13/16" (326 mm)	8-7/16" (214 mm)	5-3/4" (145 mm)	B-PT Stream regulator	—	Lever	N	00CC 1/2" NPT male inlets
B-0321-NPL	Eterna	5-3/4" swivel/rigid gooseneck (133X)	13-1/4" (337 mm)	8-13/16" (225 mm)	5-3/4" (145 mm)	B-PT Stream regulator	—	Lever	N	Includes B-0425 1/2" NPT male supply nipple kit
B-0327	Eterna	5-3/4" swivel/rigid gooseneck (133X-A22)	13-3/16" (335 mm)	8-3/4" (223 mm)	5-3/4" (145 mm)	B-0199-01 aerator	2.2 GPM	4" Wrist-action	N	00EE 1/2" NPT male adjustable flange

VR Vandal-resistant

C
14

B-0225 Series Double Pantry Faucet

- 4" (102 mm) deck mount mixing faucet
- Swing/rigid nozzle
- Quarter-turn cartridges with cross flow prevention
- Lever handles with color coded indexes
- 1/2" NPT female inlets



MODEL	1/4-Turn CARTRIDGE w/ Cross Flow Prevention	NOZZLE	HEIGHT	CLEARANCE	SPREAD	OUTLET	GPM	HANDLE	VR	NOTES
B-0225	Eterna	12" swivel/rigid nozzle (062X)	10" (254 mm)	6-7/8" (174 mm)	12" (305 mm)	B-PT Stream Regulator	—	Lever	N	
B-0225-61X-CCCR	Cerama	10" swivel/rigid nozzle (061X)	8-15/16" (227 mm)	5-13/16" (148 mm)	10" (254 mm)	B-PT Stream regulator	—	Lever	N	00CC 1/2" NPT male inlets
B-0225-CC-CR	Cerama	12" swivel/rigid nozzle (062X)	9-9/16" (244 mm)	6-7/8" (174 mm)	12" (305 mm)	B-PT Stream Regulator	—	Lever	N	00CC 1/2" NPT male inlets
B-0225-M	Eterna	12" swivel/rigid nozzle (062X)	10" (254 mm)	6-7/8" (174 mm)	12" (305 mm)	B-PT Stream Regulator	—	Lever	N	B-0225 Master carton of 6

VR Vandal-resistant



B-0225 Series Double Pantry Faucet

Chart, cont.



MODEL	1/4-Turn CARTRIDGE w/ Cross Flow Prevention	NOZZLE	HEIGHT	CLEARANCE	SPREAD	OUTLET	GPM	HANDLE	VR	NOTES
B-0225-CC	Eterna	12" swivel/rigid nozzle (062X)	9-9/16" (244 mm)	6-7/16" (164 mm)	12" (305 mm)	B-PT Stream Regulator	—	Lever	N	00CC 1/2" NPT male inlets
B-0225-CR	Cerama	12" swivel/rigid nozzle (062X)	10" (254 mm)	6-3/4" (172 mm)	12" (305 mm)	B-PT Stream Regulator	—	Lever	N	
B-0225-CR-LN	Cerama	—	5-1/18" (130 mm)	—	—	—	—	Lever	N	Less nozzle
B-0225-EELN	Eterna	—	5-1/16" (128 mm)	—	—	—	—	Lever	N	00EE 1/2" NPT male inlets w/ adj. flange; less nozzle
B-0225-LN	Eterna	—	5-3/16" (131 mm)	—	—	—	—	Lever	N	Less nozzle
B-0225-LN-CC-CR	Cerama	—	4-11/16" (119 mm)	—	—	—	—	Lever	N	00CC 1/2" NPT male inlets
B-0225-LNM	Eterna	—	5-3/16" (131 mm)	—	—	—	—	Lever	N	-LN Master carton of 6
B-0226	Eterna	10" swivel/rigid nozzle (061X)	9-3/8" (238 mm)	6-1/4" (159 mm)	10" (254 mm)	B-PT Stream Regulator	—	Lever	N	
B-0226-CC	Eterna	10" swivel/rigid nozzle (061X)	8-15/16" (227 mm)	5-13/16" (147 mm)	10" (254 mm)	B-PT Stream Regulator	—	Lever	N	00CC 1/2" NPT male inlets
B-0227	Eterna	8" swivel/rigid nozzle (060X)	8-5/8" (220 mm)	5-1/2" (140 mm)	8" (203 mm)	B-PT Stream Regulator	—	Lever	N	
B-0227-CC	Eterna	8" swivel/rigid nozzle (060X)	8-3/16" (209 mm)	5-1/16" (129 mm)	8" (203 mm)	B-PT Stream Regulator	—	Lever	N	00CC 1/2" NPT male inlets
B-0227-M	Eterna	8" swivel/rigid nozzle (060X)	8-5/8" (220 mm)	5-1/2" (140 mm)	8" (203 mm)	B-PT Stream Regulator	—	Lever	N	B-0227 Master carton of 6
B-0228	Eterna	6" swivel/rigid nozzle (059X)	8-1/16" (205 mm)	4-15/16" (126 mm)	6" (152 mm)	B-PT Stream Regulator	—	Lever	N	
B-0228-CR	Cerama	6" swivel/rigid nozzle (059X)	8-1/16" (205 mm)	4-15/16" (126 mm)	6" (152 mm)	B-PT Stream Regulator	—	Lever	N	
B-0228-M	Eterna	6" swivel/rigid nozzle (059X)	8-1/16" (205 mm)	4-15/16" (126 mm)	6" (152 mm)	B-PT Stream Regulator	—	Lever	N	B-0228 Master carton of 6
B-2283	Eterna	6" swivel/rigid nozzle (059X)	8" (203 mm)	5" (125 mm)	6" (152 mm)	B-PT Stream Regulator	—	Lever	N	Includes (2) B-0425 1/2" NPT male supply nipple kits
B-2283-CR	Cerama	6" swivel/rigid nozzle (059X)	8" (203 mm)	5" (125 mm)	6" (152 mm)	B-PT Stream Regulator	—	Lever	N	Includes (2) B-0425 1/2" NPT male supply nipple kits
B-2283-065X	Eterna	18" swivel/rigid nozzle (065X)	12" (306 mm)	9" (226 mm)	18" (457 mm)	B-PT Stream Regulator	—	Lever	N	Includes (2) B-0425 1/2" NPT male supply nipple kits

VR Vandal-resistant

Find Nozzles, Aerators, Goosenecks and Handles in our G-12 Accessories section (ACS)



B-0325 Series Double Pantry Faucet

- 4" (102 mm) deck mount mixing faucet
- Swivel/rigid gooseneck
- Quarter-turn cartridges with cross flow prevention
- Lever handles with color coded indexes
- 1/2" NPT female inlets



MODEL	1/4-Turn CARTRIDGE w/ Cross Flow Prevention	GOOSENECK	HEIGHT	CLEARANCE	SPREAD	OUTLET	GPM	HANDLE	VR	NOTES
B-0325	Eterna	5-3/4" swivel/rigid gooseneck (133X)	13-1/4" (336 mm)	8-3/4" (225 mm)	5-3/4" (145 mm)	B-PT Stream Regulator	–	Lever	N	
B-0325-134X-CR4	Cerama	7-3/4" swivel/rigid gooseneck (134X)	13-3/16" (335 mm)	8-9/16" (218 mm)	7-3/4" (197 mm)	B-PT Stream Regulator	–	4" Wrist-action	N	
B-0325-A22	Eterna	5-3/4" swivel/rigid gooseneck (133X-A22)	13-1/4" (336 mm)	8-3/4" (225 mm)	5-3/4" (145 mm)	B-0199-01 aerator	2.2 GPM	Lever	N	
B-0325-CC-CR	Cerama	5-3/4" swivel/rigid gooseneck (133X)	13-3/16" (335 mm)	8-7/16" (215 mm)	5-3/4" (145 mm)	B-PT Stream Regulator	–	Lever	N	00CC 1/2" NPT male inlets
B-0325-CC-CR-W4	Cerama	5-3/4" swivel/rigid gooseneck (133X)	13-3/16" (335 mm)	8-7/16" (215 mm)	5-3/4" (145 mm)	B-PT Stream Regulator	–	4" Wrist-action	N	00CC 1/2" NPT male inlets
B-0325-CR	Cerama	5-3/4" swivel/rigid gooseneck (133X)	13-1/4" (336 mm)	8-3/4" (225 mm)	5-3/4" (145 mm)	B-PT Stream Regulator	–	Lever	N	
B-0325-CR-WH4	Cerama	5-3/4" swivel/rigid gooseneck (133X)	13-5/16" (338 mm)	8-7/8" (225 mm)	5-3/4" (145 mm)	B-PT Stream Regulator	–	4" Wrist-action	N	
B-0325-LNCC	Eterna	–	4-3/4" (121 mm)	–	–	–	–	Lever	N	00CC 1/2" NPT male inlets, less nozzle
B-0325-NPL	Eterna	5-3/4" swivel/rigid gooseneck (133X)	13-1/4" (337 mm)	8-3/4" (225 mm)	5-3/4" (145 mm)	B-PT Stream Regulator	–	Lever	N	B-0425 1/2" NPT male supply nipple kit included
B-0325-WH4	Eterna	5-3/4" swivel/rigid gooseneck (133X)	13-1/4" (336 mm)	8-3/4" (225 mm)	5-3/4" (145 mm)	B-PT Stream Regulator	–	4" Wrist-action	N	
B-0326-LN	Eterna	–	5-3/16" (131 mm)	–	–	–	–	Lever	N	Less nozzle
B-0328-CR-VF05	Cerama	5-3/4" swivel/rigid gooseneck	13-5/16" (338 mm)	8-7/8" (225 mm)	5-3/4" (145 mm)	B-0199-06-N05 VR Non-aerated spray device	0.5 GPM	4" Wrist-action	Y	
B-2501	Eterna	6" Cast spout (OCS6)	5-1/4" (134 mm)	3-5/8" (93 mm)	6" (152 mm)	B-0199-01 Aerator	2.2 GPM	Lever	N	
B-2501-CR	Cerama	6" Cast spout (OCS6)	5-1/4" (134 mm)	3-5/8" (93 mm)	6" (152 mm)	B-0199-01 Aerator	2.2 GPM	Lever	N	

VR Vandal-resistant



B-0230 Series Double Pantry Faucet

- 8" (203 mm) wall mount mixing faucet
- Swing/rigid nozzle
- Quarter-turn cartridges with cross flow prevention
- Lever handles with color coded indexes
- 1/2" NPT female inlets



MODEL	1/4-Turn CARTRIDGE w/ Cross Flow Prevention	NOZZLE	HEIGHT	CLEARANCE	SPREAD	OUTLET	GPM	HANDLE	VR	NOTES
B-0230	Eterna	18" swivel/rigid nozzle (065X)	9-9/16" (243 mm)	6-7/16" (163 mm)	18" (457 mm)	B-PT Stream regulator	—	Lever	N	
B-0230-01	Eterna	6" Cast spout (OCS6-V22)	3-11/16" (94 mm)	1-1/8" (29mm)	6" (152 mm)	B-0199-01 aerator	2.2 GPM	Lever	N	
B-0230-01-QT-VR	Eterna	6" Cast spout (OCS6-V22)	3-11/16" (94 mm)	1-1/8" (29mm)	6" (152 mm)	B-0199-06 VR Aerator	2.2 GPM	Lever	Y	VR handle screws
B-0230-02	Eterna	18" swivel/rigid nozzle (065X-A22)	9-3/4" (248 mm)	6-5/8" (169 mm)	18" (457 mm)	B-0199-01 aerator	2.2 GPM	Lever	N	
B-0230-14-CR-SC	Cerama	14" swivel/rigid nozzle (063X)	8-3/16" (207 mm)	5-1/16" (128 mm)	14" (356 mm)	B-PT Stream regulator	—	Lever	N	
B-0230-166X-CRK	Cerama	9" swivel/rigid nozzle (166X)	8-3/4" (223 mm)	5-13/16" (147 mm)	9" (229 mm)	B-PT Stream regulator	—	Lever	N	B-0230-K Short elbow installation kit included
B-0230-BST	Eterna	18" swivel/rigid nozzle (065X)	9-9/16" (243 mm)	6-13/16" (174 mm)	18" (457 mm)	B-PT Stream regulator	—	Lever	N	-BST Built-in stops
B-0230-CC	Eterna	18" swivel/rigid nozzle (065X)	9-9/16" (243 mm)	6-3/8" (162 mm)	18" (457 mm)	B-PT Stream regulator	—	Lever	N	00CC 1/2" NPT male inlets
B-0230-CC-CR	Cerama	18" swivel/rigid nozzle (065X)	9-9/16" (243 mm)	6-3/8" (162 mm)	18" (457 mm)	B-PT Stream regulator	—	Lever	N	00CC 1/2" NPT male inlets
B-0230-CCLN	Eterna	—	3-11/16" (94 mm)	—	—	—	—	Lever	N	00CC 1/2" NPT male inlets, less nozzle
B-0230-CCLNM	Eterna	—	3-11/16" (94 mm)	—	—	—	—	Lever	N	-CCLN Master carton of 6
B-0230-CR	Cerama	18" swivel/rigid nozzle (065X)	9-1/2" (242 mm)	6-7/16" (163 mm)	18" (457 mm)	B-PT Stream regulator	—	Lever	N	
B-0230-CR-02	Cerama	18" swivel/rigid nozzle (065X)	9-1/2" (242 mm)	6-7/16" (163 mm)	18" (457 mm)	B-0199-01 aerator	2.2 GPM	Lever	N	
B-0230-CR-SC-EK	Cerama	18" swivel/rigid nozzle (065X)	9-1/2" (242 mm)	6-7/16" (163 mm)	18" (457 mm)	B-PT Stream regulator	—	Lever	N	B-0230-K short el installation kit
B-0230-CR-LN	Cerama	—	3-11/16" (94 mm)	—	—	—	—	Lever	N	B-0230-CR less nozzle
B-0230-EE	Eterna	18" swivel/rigid nozzle (065X)	9-9/16" (243 mm)	6-3/8" (162 mm)	18" (457 mm)	B-PT Stream regulator	—	Lever	N	00EE 1/2" NPT male inlets w/ adj. flange
B-0230-EE-061X	Eterna	10" swivel/rigid nozzle (061X)	7" (178 mm)	3-11/16" (94 mm)	10" (254 mm)	B-PT Stream regulator	—	Lever	N	00EE 1/2" NPT male inlets w/ adj. flange
B-0230-EELN	Eterna	—	3-11/16" (94 mm)	—	—	—	—	Lever	N	00EE 1/2" NPT male inlets w/ adj. flange; less nozzle
B-0230-LN	Eterna	—	3-11/16" (94 mm)	—	—	—	—	Lever	N	B-0230 less nozzle

C
17



B-0230 Series Double Pantry Faucet

Chart, cont.



MODEL	1/4-Turn CARTRIDGE w/ Cross Flow Prevention	NOZZLE	HEIGHT	CLEARANCE	SPREAD	OUTLET	GPM	HANDLE	VR	NOTES
B-0230-LNM	Eterna	—	3-11/16" (94 mm)	—	—	—	—	Lever	N	-LN Master carton of 6
B-0230-M	Eterna	18" Swing nozzle (065X)	9-9/16" (243 mm)	6-7/16" (163 mm)	18" (457 mm)	B-PT Stream regulator	—	Lever	N	B-0230 Master carton of 6
B-0230-OCS8-CR	Cerama	8" swing/rigid cast spout (OCS8-LT)	5-5/8" (142 mm)	4-7/16" (113 mm)	8" (203 mm)	B-LT Stream regulator	—	Lever	N	Optional swivel to rigid lock washer
B-0230-14-CR-SC	Cerama	14" swing/rigid nozzle (063X)	8-3/16" (207 mm)	5-1/16" (129 mm)	14" (356 mm)	B-PT Stream regulator	—	Lever	N	
B-0231	Eterna	12" swing/rigid nozzle (062X)	7-1/2" (191 mm)	4-3/8" (111 mm)	12" (305 mm)	B-PT Stream regulator	—	Lever	N	
B-0231-02	Eterna	12" swing/rigid nozzle (062X)	7-1/2" (191 mm)	4-3/8" (111 mm)	12" (305 mm)	B-PT Stream regulator	—	Lever	N	Includes B-0230-K 1/2" NPT male short elbow inlet kit (2)
B-0231-A22-CVH	Eterna	12" swing/rigid nozzle (062X-A22)	7-1/2" (191 mm)	4-3/8" (111 mm)	12" (305 mm)	B-0199-01 aerator	2.2 GPM	Lever	N	Includes (2) B-CVH1-2 1/2" NPT female check valves
B-0231-BB-CR	Cerama	12" swing/rigid nozzle (062X)	7-1/2" (191 mm)	4-3/8" (111 mm)	12" (305 mm)	B-PT Stream regulator	—	Lever	N	00BB 3/4" NPT female inlet flanges
B-0231-BST	Eterna	12" swing/rigid nozzle (062X)	7-1/2" (191 mm)	4-3/8" (111 mm)	12" (305 mm)	B-PT Stream regulator	—	Lever	N	1/2" BST built-in stops
B-0231-CC	Eterna	12" swing/rigid nozzle (062X)	7-1/2" (191 mm)	4-3/8" (111 mm)	12" (305 mm)	B-PT Stream regulator	—	Lever	N	00CC 1/2" NPT male inlets
B-0231-CC-CR	Cerama	12" swing/rigid nozzle (062X)	7-1/2" (191 mm)	4-3/8" (111 mm)	12" (305 mm)	B-PT Stream regulator	—	Lever	N	00CC 1/2" NPT male inlets
B-0231-CCM	Eterna	12" swing/rigid nozzle (062X)	7-1/2" (191 mm)	4-3/8" (111 mm)	12" (305 mm)	B-PT Stream regulator	—	Lever	N	B-0231-CC Master carton of 6
B-0231-CR	Cerama	12" swing/rigid nozzle (062X)	7-1/2" (191 mm)	4-3/8" (111 mm)	12" (305 mm)	B-PT Stream regulator	—	Lever	N	
B-0231-CR-EK	Cerama	12" swing/rigid nozzle (062X)	7-1/2" (191 mm)	4-3/8" (111 mm)	12" (305 mm)	B-PT Stream regulator	—	Lever	N	Includes B-0230-K 1/2" NPT male short elbow inlet kit (2)
B-0231-CR-KIT	Cerama	12" swing/rigid nozzle (062X)	7-1/2" (191 mm)	4-3/8" (111 mm)	12" (305 mm)	B-PT Stream regulator	—	Lever	N	Includes B-0230-K 1/2" NPT male short elbow inlet kit (2) and 24" flex. hoses (2)
B-0231-CR-M	Cerama	12" swing/rigid nozzle (062X)	7-1/2" (191 mm)	4-3/8" (111 mm)	12" (305 mm)	B-PT Stream regulator	—	Lever	N	B-0231-CR Master carton of 6
B-0231-CR-SC	Cerama	12" swing/rigid nozzle (062X)	7-1/2" (191 mm)	4-3/8" (111 mm)	12" (305 mm)	B-PT Stream regulator	—	Lever	N	
B-0231-CR-SC-F1	Cerama	12" swing/rigid nozzle (062X)	7-1/2" (191 mm)	4-3/8" (111 mm)	12" (305 mm)	B-0199-06-F10 VR aerator	1.0 GPM	Lever	Y	
B-0231-CR4-L22	Cerama	12" swing/rigid nozzle (062X-L22)	7-1/2" (191 mm)	4-3/8" (111 mm)	12" (305 mm)	B-0199-21 Laminar flow	2.2 GPM	4" Wrist-action	N	
B-0231-EE	Eterna	12" swing/rigid nozzle (062X)	7-1/2" (191 mm)	4-3/8" (111 mm)	12" (305 mm)	B-PT Stream regulator	—	Lever	N	00EE 1/2" NPT male inlets w/ adj. flange

VR Vandal-resistant

Chart cont. next page



B-0230 Series Double Pantry Faucet

Chart, cont.

B-0231-WH4



MODEL	1/4-Turn CARTRIDGE w/ Cross Flow Prevention	NOZZLE	HEIGHT	CLEARANCE	SPREAD	OUTLET	GPM	HANDLE	VR	NOTES
B-0231-EE-A22	Eterna	12" swing/rigid nozzle (062X-A22)	7-1/2" (191 mm)	4-3/8" (111 mm)	12" (305 mm)	B-0199-01 aerator	2.2 GPM	Lever	N	00EE 1/2" NPT male inlets w/ adj. flange
B-0231-EE-A22CR	Cerama	12" swing/rigid nozzle (062X-A22)	7-1/2" (191 mm)	4-3/8" (111 mm)	12" (305 mm)	B-0199-01 aerator	2.2 GPM	Lever	N	00EE 1/2" NPT male inlets w/ adj. flange
B-0231-02	Eterna	12" swing/rigid nozzle (062X)	7-1/2" (191 mm)	4-3/8" (111 mm)	12" (305 mm)	B-PT Stream regulator	—	Lever	N	Includes B-0230-K 1/2" NPT male short elbow inlet kit (2)
B-0231-EEM	Eterna	12" swing/rigid nozzle (062X)	7-1/2" (191 mm)	4-3/8" (111 mm)	12" (305 mm)	B-PT Stream regulator	—	Lever	N	-00 EE Master carton of 6
B-0231-M	Eterna	12" swing/rigid nozzle (062X)	7-1/2" (191 mm)	4-3/8" (111 mm)	12" (305 mm)	B-PT Stream regulator	—	Lever	N	B-0231 Master carton of 6
B-0231-VF22-EL	Eterna	12" swing/rigid nozzle	7-1/2" (191 mm)	4-3/8" (111 mm)	12" (305 mm)	B-0199-06 VR aerator	2.2 GPM	Lever	Y	Includes B-0230-K 1/2" NPT male short elbow inlet kit (2)
B-0231-WH4	Eterna	12" swing/rigid nozzle (062X)	7-1/2" (191 mm)	4-3/8" (111 mm)	12" (305 mm)	B-PT Stream regulator	—	4" Wrist-action	N	
B-0232	Eterna	6" swing/rigid nozzle (059X)	5-5/8" (142 mm)	2-1/2" (63 mm)	6" (152 mm)	B-PT Stream regulator	—	Lever	N	
B-0232-BST	Eterna	6" swing/rigid nozzle (059X)	5-5/8" (142 mm)	2-1/2" (63 mm)	6" (152 mm)	B-PT Stream regulator	—	Lever	N	-BST built-in stops
B-0232-CC	Eterna	6" swing/rigid nozzle (059X)	5-5/8" (142 mm)	2-1/2" (63 mm)	6" (152 mm)	B-PT Stream regulator	—	Lever	N	00CC 1/2" NPT male inlets
B-0232-CC-CR	Cerama	6" swing/rigid nozzle (059X)	5-5/8" (142 mm)	2-1/2" (63 mm)	6" (152 mm)	B-PT Stream regulator	—	Lever	N	00CC 1/2" NPT male inlets
B-0232-EE	Eterna	6" swing/rigid nozzle (059X)	5-5/8" (142 mm)	2-1/2" (63 mm)	6" (152 mm)	B-PT Stream regulator	—	Lever	N	00EE 1/2" NPT male inlets
B-0232-ELK	Eterna	6" swing/rigid nozzle (059X)	5-5/8" (142 mm)	2-1/2" (63 mm)	6" (152 mm)	B-PT Stream regulator	—	Lever	N	Includes B-0230-K 1/2" NPT male short elbow inlet kit (2)
B-0232-F1-CR-SC	Cerama	6" swing/rigid nozzle (059X)	5-5/8" (142 mm)	2-1/2" (63 mm)	6" (152 mm)	B-0199-01-F10 aerator	1.0 GPM	Lever	N	
B-0232-M	Eterna	6" swivel/rigid nozzle (059X)	5-5/8" (142 mm)	2-1/2" (63 mm)	6" (152 mm)	B-PT Stream regulator	—	Lever	N	B-0232 Master carton of 6
B-0234-BST	Eterna	(OCS6) 6" Cast spout	3-13/16" (98 mm)	1-3/16" (29 mm)	6" (152 mm)	B-0199-02 aerator	2.2 GPM	Lever	N	-BST Built-in stops
B-0234-EE	Eterna	(OCS6) 6" Cast spout	3-13/16" (98 mm)	1-3/16" (29 mm)	6" (152 mm)	B-0199-02 aerator	2.2 GPM	Lever	N	00EE 1/2" NPT male inlets w/ adj. flanges
B-0265	Eterna	18" double-joint swing/rigid nozzle (068X)	7-9/16" (191 mm)	4-3/8" (111 mm)	18" (457 mm)	B-PT Stream regulator	—	Lever	N	
B-0265-BST	Eterna	18" double-joint swing/rigid nozzle (068X)	7-9/16" (191 mm)	4-3/8" (111 mm)	18" (457 mm)	B-PT Stream regulator	—	Lever	N	-BST Built-in stops
B-0266	Eterna	15" double-joint swing/rigid nozzle (067X)	7-9/16" (191 mm)	4-5/16" (110 mm)	15" (382 mm)	B-PT Stream regulator	—	Lever	N	

VR Vandal-resistant



B-0230 Series Double Pantry Faucet

Chart, cont.



MODEL	1/4-Turn CARTRIDGE w/ Cross Flow Prevention	NOZZLE	HEIGHT	CLEARANCE	SPREAD	OUTLET	GPM	HANDLE	VR	NOTES
B-0267	Eterna	12" double-joint swing/rigid nozzle (066X)	7-9/16" (191 mm)	4-5/16" (110 mm)	12" (305 mm)	B-PT Stream regulator	—	Lever	N	
B-0267-BST	Eterna	12" double-joint swing/rigid nozzle (066X)	7-9/16" (191 mm)	4-5/16" (110 mm)	12" (305 mm)	B-PT Stream regulator	—	Lever	N	-BST Built-in stops
B-2299	Eterna	14" swing/rigid nozzle (063X)	8-3/16" (208 mm)	5-1/16" (129 mm)	14" (356 mm)	B-PT Stream regulator	—	Lever	N	
B-2299-CR	Cerama	14" swing/rigid nozzle (063X)	8-3/16" (208 mm)	5-1/16" (129 mm)	14" (356 mm)	B-PT Stream regulator	—	Lever	N	
B-2299-VF22-CR	Cerama	14" swing/rigid nozzle (063X-V22)	8-3/16" (208 mm)	5-1/16" (129 mm)	14" (356 mm)	B-0199-06 VR Aerator	2.2 GPM	Lever	Y	
B-2342	Eterna	10" swing/rigid nozzle (061X)	7-1/16" (179 mm)	3-7/8" (9 mm)	10" (254 mm)	B-PT Stream regulator	—	Lever	N	
B-2358	Eterna	14" swing/rigid nozzle (063X)	8-3/16" (81 mm)	5-1/16" (129 mm)	14" (356 mm)	B-PT Stream regulator	—	Lever	N	Includes B-0425 1/2" NPT male supply nipple kits (2), 1/2" NPT female short els
B-2429-CR-EK	Cerama	10" swing/rigid nozzle (061X)	6-7/8" (174 mm)	3-11/16" (94 mm)	10" (254 mm)	B-PT Stream Regulator	—	Lever	N	B-0230-K 1/2" NPT Short elbow kit

VR Vandal-resistant

C
20

B-0233-01 Series Double Pantry Faucet

- 8" (203 mm) wall mount mixing faucet
- B-LT stream regulator (Series 2)
- Quarter-turn cartridges with cross flow prevention
- Lever handles with color coded indexes
- 1/2" NPT female eccentric flanged inlets (00AA)



MODEL	1/4-Turn CARTRIDGE w/ Cross Flow Prevention	NOZZLE	HEIGHT	CLEARANCE	SPREAD	OUTLET	GPM	HANDLE
B-0233-01	Eterna	6" swing/rigid soap dish nozzle (160X)	4-15/16" (109 mm)	—	6" (152 mm)	B-LT Stream Regulator	—	Lever
B-0233-02	Eterna	8" swing/rigid soap dish nozzle (161X)	4-15/16" (109 mm)	15/16" (23 mm)	8" (203 mm)	B-LT Stream Regulator	—	Lever
B-0233-03	Eterna	12" swing/rigid soap dish nozzle (162X)	4-15/16" (109 mm)	2-7/8" (72 mm)	12" (305 mm)	B-LT Stream Regulator	—	Lever
B-0233-04	Eterna	18" swing/rigid soap dish nozzle (163X)	4-15/16" (109 mm)	5-3/16" (131 mm)	18" (457 mm)	B-LT Stream Regulator	—	Lever



B-0330 Series Double Pantry Faucet

- 8" (203 mm) wall mount mixing faucet
- Quarter-turn cartridges with cross flow prevention
- Lever handles with color coded indexes
- 1/2" NPT female eccentric flanged inlets (00AA)



B-0331

MODEL	1/4-Turn CARTRIDGE w/ Cross Flow Prevention	GOOSENECK	HEIGHT	CLEARANCE	SPREAD	OUTLET	GPM	HANDLE	VR	NOTES
B-0330-01	Eterna	2-5/8" swivel/rigid gooseneck (132X)	9" (229 mm)	6" (152 mm)	2-7/8" (73 mm)	B-LT Stream Regulator	—	Lever	N	
B-0330-01-W4F12	Eterna	2-7/8" swivel/rigid gooseneck	9" (229 mm)	6" (152 mm)	2-7/8" (73 mm)	B-0199-01-F12 aerator	1.2 GPM	4" Wrist-action	N	
B-0330-01-WH4	Eterna	2-5/8" swivel/rigid gooseneck (132X)	9-1/2" (241 mm)	6" (152 mm)	2-7/8" (73 mm)	B-LT Stream Regulator	—	4" Wrist-action	N	
B-0330-04	Eterna	5-3/4" swivel/rigid gooseneck (133X)	10-13/16" (274 mm)	6-3/8" (162 mm)	5-3/4" (145 mm)	B-PT Stream Regulator	—	4" Wrist-action	N	
B-0330-BST	Eterna	5-1/2" swivel/rigid gooseneck (120X)	10-15/16" (278 mm)	5-15/16" (150 mm)	5-1/2" (140 mm)	B-LT Stream Regulator	—	Lever	N	-BST built-in stops
B-0330-LN	Eterna	—	3-11/16" (94 mm)	—	—	—	—	Lever	N	Less gooseneck
B-0330CR-PRISON	Cerama	5-3/4" swivel/rigid gooseneck	10-5/8" (270 mm)	6-3/16" (157 mm)	5-3/4" (145 mm)	B-0199-06-F10 VR aerator	1.0 GPM	Lever (solid brass chrome plated)	Y	Includes VR handle screws; VR aerator key
B-0331	Eterna	5-3/4" swivel/rigid gooseneck (133X)	10-13/16" (274 mm)	6-3/8" (162 mm)	5-3/4" (145 mm)	B-PT Stream Regulator	—	Lever	N	
B-0331-BST	Eterna	5-3/4" swivel/rigid gooseneck (133X)	10-13/16" (274 mm)	6-3/4" (172 mm)	5-3/4" (145 mm)	B-PT Stream Regulator	—	Lever	N	-BST built-in stops
B-0331-CC	Eterna	5-3/4" swivel/rigid gooseneck (133X)	10-13/16" (274 mm)	6-11/16" (170 mm)	5-3/4" (145 mm)	B-PT Stream Regulator	—	Lever	N	00CC 1/2" NPT male inlets
B-0331-CR	Cerama	5-3/4" swivel/rigid gooseneck (133X)	10-13/16" (274 mm)	6-11/16" (170 mm)	5-3/4" (145 mm)	B-PT Stream Regulator	—	Lever	N	
B-0331-CR4-L22	Cerama	5-3/4" swivel/rigid gooseneck (133X-LAM)	10-13/16" (274 mm)	6-3/8" (162 mm)	5-3/4" (145 mm)	B-0199-21 Laminar Flow Device	2.2 GPM	4" Wrist-action	N	
B-0331-VF22-EL	Eterna	5-3/4" swivel/rigid gooseneck (133X-V22)	10-13/16" (274 mm)	6-5/16" (160 mm)	5-3/4" (145 mm)	B-0199-06 VR aerator	2.2 GPM	Lever	Y	Includes B-0230-K 1/2" NPT male short elbow inlet kit (2); VR key
B-0230-CR-WH4	Cerama	Swivel gooseneck (133X)	10-13/16" (274 mm)	6-3/8" (161 mm)	5-3/4" (145 mm)	B-PT Stream regulator	—	4" Wrist-action	N	

VR Vandal-resistant



**B-0235
Double Pantry Faucet**

- Wall mount mixing faucet
- Swing/rigid nozzle
- Quarter-turn cartridges with cross flow prevention
- Lever handles with color coded indexes
- 1/2" NPT female adjustable arm inlet flanges (O0GG)
- Centers adjustable from 2-1/4" (57 mm) to 8-1/4" (210 mm)

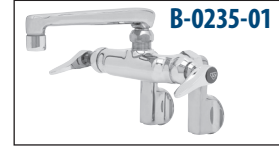

MODEL	1/4-Turn CARTRIDGE w/ Cross Flow Prevention	NOZZLE	HEIGHT	CLEARANCE	SPREAD	OUTLET	GPM	HANDLE	NOTES
B-0235	Eterna	18" swing/rigid nozzle (065X)	9-9/16" (243 mm)	6-7/16" (163 mm)	18" (457 mm)	B-PT Stream Regulator	-	Lever	
B-0235-01	Eterna	6" Cast spout (0CS6)	2-7/8" (72 mm)	1-3/16" (30 mm)	6" (152 mm)	B-0199-02 Aerator	2.2 GPM	Lever	
B-0235-61X-CREK	Cerama	10" swing/rigid nozzle (061X)	6-7/8" (174 mm)	3-3/4" (95 mm)	10" (254 mm)	B-PT Stream Regulator	-	Lever	Includes B-0230-K Inst. Kit
B-0235-CC	Eterna	18" swing/rigid nozzle (065X)	9-11/16" (246 mm)	6-13/16" (173 mm)	18" (457 mm)	B-PT Stream Regulator	-	Lever	O0CC 1/2" NPT Male inlets
B-0235-LN	Eterna	-	-	-	-	-	-	Lever	Less nozzle
B-0235-LNM	Eterna	-	-	-	-	-	-	Lever	-LN Master carton of 6
B-0236	Eterna	12" swing/rigid nozzle (062X)	7-9/16" (191 mm)	4-3/8" (112 mm)	12" (305 mm)	B-PT Stream Regulator	-	Lever	
B-0236-CR	Cerama	12" swing/rigid nozzle (062X)	7-9/16" (191 mm)	4-3/8" (112 mm)	12" (305 mm)	B-PT Stream Regulator	-	Lever	
B-0236-CR-EK	Cerama	12" swing/rigid nozzle (062X)	7-9/16" (191 mm)	4-3/8" (112 mm)	12" (305 mm)	B-PT Stream Regulator	-	Lever	Includes B-0230-K Inst. Kit
B-0236-CR-063X	Cerama	14" swing/rigid nozzle (063X)	8-1/8" (207 mm)	5-1/16" (129 mm)	14" (356 mm)	B-PT Stream Regulator	-	Lever	
B-0236-M	Eterna	12" swing/rigid nozzle (062X)	7-9/16" (191 mm)	4-3/8" (112 mm)	12" (305 mm)	B-PT Stream Regulator	-	Lever	Master carton of 6
B-0237	Eterna	6" swing/rigid nozzle (059X)	5-9/16" (145 mm)	2-7/16" (63 mm)	6" (152 mm)	B-PT Stream Regulator	-	Lever	



B-0240 Double Pantry Faucet

- Wall mount mixing faucet with integral screwdriver stops
- Quarter-turn cartridges with cross flow prevention
- Lever handles with color coded indexes
- 1/2" NPT female adjustable arm inlet flanges with screwdriver stops (00XX)
- Centers adjustable from 2-1/4" (57 mm) to 8-1/4" (210 mm)



B-0240



B-0242

MODEL	1/4-Turn CARTRIDGE w/ Cross Flow Prevention	NOZZLE	HEIGHT	CLEARANCE	SPREAD	OUTLET	GPM	HANDLE	NOTES
B-0240	Eterna	18" swing/rigid nozzle (065X)	9-9/16" (243 mm)	6-7/16" (163 mm)	18" (457 mm)	B-PT Stream Regulator	—	Lever	
B-0240-LN	Eterna	—	—	—	—	—	—	Lever	Less nozzle
B-0241	Eterna	12" swing/rigid nozzle (062X)	7-9/16" (191 mm)	4-3/8" (112 mm)	12" (305 mm)	B-PT Stream Regulator	—	Lever	
B-0242	Eterna	6" swing/rigid nozzle (059X)	5-9/16" (141 mm)	2-7/16" (63 mm)	6" (152 mm)	B-PT Stream Regulator	—	Lever	
B-0243	Eterna	6" swing/rigid Cast spout (0CS6)	2-13/16" (71 mm)	1-3/16" (30 mm)	6" (152 mm)	B-0199-02 Aerator	2.2 GPM	Lever	

B-0341 Double Pantry Faucet

- Wall mount mixing faucet
- 5-3/4" (140 mm) swivel/rigid gooseneck (133X)
- B-PT stream regulator outlet (Series 1)
- Quarter-turn cartridges with cross flow prevention
- Lever handles with color coded indexes
- 1/2" NPT female adjustable inlet arms from 2-1/4" (57 mm) to 8-1/4" (210 mm) above or below C/C (00GG)



B-0341

MODEL	1/4-Turn CARTRIDGE w/ Cross Flow Prevention	GOOSENECK	HEIGHT	CLEARANCE	SPREAD	OUTLET	GPM	HANDLE	NOTES
B-0340-LN	Eterna	—	—	—	—	—	—	Lever	Less nozzle
B-0341	Eterna	5-3/4" swivel/rigid gooseneck (133X)	10-13/16" (275 mm)	6-1/2" (165 mm)	5-3/4" (145 mm)	B-PT Stream Regulator	—	Lever	
B-0342	Eterna	5-3/4" swivel/rigid gooseneck (133X)	10-13/16" (275 mm)	6-3/8" (162 mm)	5-3/4" (145 mm)	B-PT Stream Regulator	—	Lever	00XX 1/2" NPT female adj. inlet w/screwdriver stops
B-0342-LN	Eterna	—	—	—	—	—	—	Lever	Less gooseneck; 00XX 1/2" NPT female adj. inlet w/screwdriver stops

Find Nozzles, Aerators, Goosenecks and Handles in our G-12 Accessories section (ACS)



B-1105 Series Workboard Faucet, 3 1/2" Centers



- 3-1/2" (89 mm) wall mount workboard faucet
- Swing/rigid nozzle
- 2.2 GPM aerator, Series 1 (B-0199-01)
- Quarter-turn cartridges with cross flow prevention
- Lever handles with color coded indexes
- Chrome plated escutcheon, 6-1/2" (165 mm) long x 2" (51 mm) wide
- 1" (25 mm) long shanks with 1/2" NPT male threads
- Includes (150A) tailpieces and nuts for 1/4" NPT connections



Note: Order the B-1100-K Elbow kit separately; includes (2) 1/2" NPT male x female short els

MODEL	1/4-Turn CARTRIDGE w/ Cross Flow Prevention	NOZZLE	HEIGHT	CLEARANCE	SPREAD	OUTLET	GPM	HANDLE	VR	NOTES
B-1105	Eterna	6" swing/rigid nozzle (059X-A22)	5-7/16" (137 mm)	2-5/16" (58 mm)	6" (152 mm)	B-0199-01 aerator	2.2 GPM	Lever	N	
B-1105-LN	Eterna	—	2" (51 mm)	—	—	—	—	Lever	N	Less nozzle
B-1105-LNM	Eterna	—	2" (51 mm)	—	—	—	—	Lever	N	-LN Master carton of 6
B-1106	Eterna	8" swing/rigid nozzle (060X-A22)	6" (152 mm)	2-7/8" (73 mm)	8" (204 mm)	B-0199-01 aerator	2.2 GPM	Lever	N	
B-1107	Eterna	10" swing/rigid nozzle (061X-A22)	6-3/4" (171 mm)	3-9/16" (91 mm)	10" (254 mm)	B-0199-01 aerator	2.2 GPM	Lever	N	
B-1108	Eterna	12" swing/rigid nozzle (062X-A22)	7-3/8" (187 mm)	4-1/4" (109 mm)	12" (305 mm)	B-0199-01 aerator	2.2 GPM	Lever	N	
B-1135	Eterna	18" Double-joint swing/rigid nozzle (068X-A22)	7-1/2" (190 mm)	4-1/4" (109 mm)	18" (457 mm)	B-0199-01 aerator	2.2 GPM	Lever	N	
B-1145	Eterna	5-3/4" swing/rigid gooseneck (133X-A22)	10-11/16" (271 mm)	6-1/4" (158 mm)	5-3/4" (145 mm)	B-0199-01 aerator	2.2 GPM	Lever	N	

VR Vandal-resistant



B-1110 Series Workboard Faucet, 4" Centers

**SERIES
1
OUTLETS**

- 4" (102 mm) deck mount workboard faucet
- Swing/rigid nozzle
- 2.2 GPM aerator, Series 1 (B-0199-01)
- Quarter-turn cartridges with cross flow prevention
- Chrome plated escutcheon, 6-1/2" (165 mm) long x 2" (51 mm) wide
- 1" (25 mm) long shanks with 1/2" NPT male threads
- Includes (150A) tailpieces and nuts for 1/4" NPT connections



MODEL	1/4-Turn CARTRIDGE w/ Cross Flow Prevention	NOZZLE	HEIGHT	CLEARANCE	SPREAD	OUTLET	GPM	HANDLE	VR	NOTES
B-1110	Eterna	6" swing/rigid nozzle (059X-A22)	6-1/8" (156 mm)	3" (76 mm)	6" (153 mm)	B-0199-01 aerator	2.2 GPM	Lever	N	
B-1110-120X	Eterna	5-9/16" rigid gooseneck	12-3/16" (310 mm)	6-11/16" (169 mm)	5-9/16" (141 mm)	B-0199-02 aerator	2.2 GPM	Lever	N	B-0413 Rigid to swivel adapter
B-1110-131X-WH4	Eterna	2-15/16" swing/rigid gooseneck (131X-A22)	5-13/16" (147 mm)	3-3/16" (81 mm)	2-15/16" (74 mm)	B-0199-01 aerator	2.2 GPM	4" Wrist-action	N	
B-1110-CR	Cerama	6" swing/rigid nozzle (059X-A22)	6-1/8" (156 mm)	3" (76 mm)	6" (153 mm)	B-0199-01 aerator	2.2 GPM	Lever	N	
B-1110-CR-LN	Cerama	—	3-1/4" (82 mm)	—	—	—	—	Lever	N	Less nozzle
B-1110-CR-LNM	Cerama	—	3-1/4" (82 mm)	—	—	—	—	Lever	N	-LN Master carton of 6
B-1110-LN	Eterna	—	3-5/16" (84 mm)	—	—	—	—	Lever	N	Less swing nozzle
B-1110-LN-WH4	Eterna	—	4-15/16" (125 mm)	—	—	—	—	4" Wrist-action	N	Less swing nozzle
B-1110-LNM	Eterna	—	3-5/16" (84 mm)	—	—	—	—	Lever	N	B-1110-LN Master carton of 6
B-1110-M	Eterna	6" swing/rigid nozzle (059X-A22)	6-1/8" (156 mm)	3" (76 mm)	6" (152 mm)	B-0199-01 aerator	2.2 GPM	Lever	N	B-1110 Master carton of 6
B-1110-XS	Eterna	6" swing/rigid nozzle (059X-A22)	6-1/8" (156 mm)	3" (76 mm)	6" (152 mm)	B-0199-01 aerator	2.2 GPM	Lever	N	2" extended shanks
B-1110-XS-LN	Eterna	—	3-5/16" (84 mm)	—	—	—	—	Lever	N	Less nozzle; 2" ext. shanks
B-1110-XS-LNM	Eterna	—	3-5/16" (84 mm)	—	—	—	—	Lever	N	-XS-LN Master carton of 6
B-1111	Eterna	8" swing/rigid nozzle (060X-A22)	6-3/4" (172 mm)	3-9/16" (91 mm)	8" (204 mm)	B-0199-01 aerator	2.2 GPM	Lever	N	
B-1111-CR	Cerama	8" swing/rigid nozzle (060X-A22)	6-3/4" (172 mm)	3-9/16" (91 mm)	8" (204 mm)	B-0199-01 aerator	2.2 GPM	Lever	N	
B-1111-CR-M	Cerama	8" swing/rigid nozzle (060X-A22)	6-3/4" (172 mm)	3-9/16" (91 mm)	8" (204 mm)	B-0199-01 aerator	2.2 GPM	Lever	N	B-1111-CR Master carton of 6
B-1111-M	Eterna	8" swing/rigid nozzle (060X-A22)	6-3/4" (172 mm)	3-9/16" (91 mm)	8" (204 mm)	B-0199-01 aerator	2.2 GPM	Lever	N	B-1111 Master carton of 6
B-1111-WH4	Eterna	8" swing/rigid nozzle (060X-A22)	6-3/4" (172 mm)	3-9/16" (91 mm)	8" (204 mm)	B-0199-01 aerator	2.2 GPM	4" Wrist-action	N	

VR Vandal-resistant

Chart cont. next page



B-1110 Series Workboard Faucet, 4" Centers

SERIES
1
OUTLETS

Chart, cont.



B-1110-XS-WH4

MODEL	1/4-Turn CARTRIDGE w/ Cross Flow Prevention	NOZZLE	HEIGHT	CLEARANCE	SPREAD	OUTLET	GPM	HANDLE	VR	NOTES
B-1111-XS	Eterna	8" swing/rigid nozzle (060X-A22)	6-3/4" (172 mm)	3-5/8" (92 mm)	8" (204 mm)	B-0199-01 aerator	2.2 GPM	Lever	N	2" extended shanks
B-1112	Eterna	10" swing/rigid nozzle (061X-A22)	7-7/16" (189 mm)	4-5/16" (109 mm)	10" (254 mm)	B-0199-01 aerator	2.2 GPM	Lever	N	
B-1112-M	Eterna	10" swing/rigid nozzle (061X-A22)	7-7/16" (189 mm)	4-5/16" (109 mm)	10" (254 mm)	B-0199-01 aerator	2.2 GPM	Lever	N	B-1112 Master carton of 6
B-1112-XS	Eterna	10" swing/rigid nozzle (061X-A22)	7-7/16" (189 mm)	4-5/16" (109 mm)	10" (254 mm)	B-0199-01 aerator	2.2 GPM	Lever	N	2" extended shanks
B-1113	Eterna	12" swing/rigid nozzle (062X-A22)	8-1/8" (206 mm)	4-15/16" (126 mm)	12" (305 mm)	B-0199-01 aerator	2.2 GPM	Lever	N	
B-1113-M	Eterna	12" swing/rigid nozzle (062X-A22)	8-1/8" (206 mm)	4-15/16" (126 mm)	12" (305 mm)	B-0199-01 aerator	2.2 GPM	Lever	N	B-1113 Master carton of 6
B-1113-XS	Eterna	12" swing/rigid nozzle (062X-A22)	8-1/8" (206 mm)	4-15/16" (126 mm)	12" (305 mm)	B-0199-01 aerator	2.2 GPM	Lever	N	2" extended shanks
B-1131	Eterna	18" Double-joint swing/rigid nozzle (068X-A22)	8-3/16" (208 mm)	5" (127 mm)	18" (457 mm)	B-0199-01 aerator	2.2 GPM	Lever	N	
B-1131-XS	Eterna	18" Double-joint swing/rigid nozzle (068X-A22)	8-3/16" (208 mm)	5" (127 mm)	18" (457 mm)	B-0199-01 aerator	2.2 GPM	Lever	N	2" extended shanks
B-1141	Eterna	5-3/4" swing/rigid gooseneck (133X-A22)	11-3/8" (289 mm)	6-15/16" (176 mm)	5-3/4" (145 mm)	B-0199-01 aerator	2.2 GPM	Lever	N	
B-1141-01	Eterna	2-15/16" (74 mm) swing/rigid gooseneck (131X-A22)	5-13/16" (147 mm)	3-3/16" (81 mm)	2-15/16" (74 mm)	B-0199-01 aerator	2.2 GPM	Lever	N	
B-1141-04-CR	Cerama	6" swing/rigid goose- neck (133X-A22)	11-3/8" (289 mm)	6-15/16" (176 mm)	5-3/4" (145 mm)	B-0199-01 aerator	2.2 GPM	4" Wrist Action	N	
B-1141-XS	Eterna	5-3/4" swing/rigid gooseneck (133X-A22)	11-1/8" (283 mm)	7-1/8" (180 mm)	5-3/4" (145 mm)	B-0199-01 aerator	2.2 GPM	Lever	N	2" extended shanks
B-1141-XS-F12	Eterna	6" swing/rigid goose- neck (133X-A12)	11-3/8" (289 mm)	6-15/16" (176 mm)	5-3/4" (145 mm)	B-0199-01-F12 aerator	1.2 GPM	Lever	N	2" extended shanks
B-1141-XSCR4V05	Cerama	5-3/4" swing/rigid gooseneck	11-3/8" (289 mm)	6-7/8" (175 mm)	5-3/4" (145 mm)	B-0199-06-N05 Non-aerated spray device	0.5 GPM	4" Wrist Action	N	2" extended shanks
B-1141-XSCR4V15	Cerama	5-3/4" swing/rigid gooseneck	11-3/8" (289 mm)	6-15/16" (176 mm)	5-3/4" (145 mm)	B-0199-06-WS VR aerator	1.5 GPM	4" Wrist Action	N	WaterSense aerator; 2" extended shanks
B-1141-XSCR4V22	Cerama	5-3/4" swing/rigid gooseneck (133X-V22)	11-3/8" (289 mm)	6-15/16" (176 mm)	5-3/4" (145 mm)	B-0199-06 VR aerator	2.2 GPM	4" Wrist Action	N	2" extended shanks



B-1115 Series Workboard Faucet, 4" Centers

**SERIES
1
OUTLETS**



Note: Order the B-1100-K Elbow kit separately; includes (2) 1/2" NPT male x female short els

- 4" (102 mm) wall-mount workboard faucet
- Swing/rigid nozzle
- 2.2 GPM aerator, Series 1 (B-0199-01)
- Quarter-turn cartridges with cross flow prevention
- Chrome plated escutcheon, 6-1/2" (165 mm) long x 2" (51 mm) wide
- 1" (25 mm) long shanks with 1/2" NPT male threads
- Includes (150A) tailpieces and nuts for 1/4" NPT connections

MODEL	1/4-Turn CARTRIDGE w/ Cross Flow Prevention	NOZZLE	HEIGHT	CLEARANCE	SPREAD	OUTLET	GPM	HANDLE	VR	NOTES
B-1115	Eterna	6" Swing/rigid nozzle (059X-A22)	5-7/16" (137 mm)	2-5/16" (58 mm)	6" (153 mm)	B-0199-01 aerator	2.2 GPM	Lever	N	
B-1115-131X-WH4	Eterna	2-15/16" Swivel/rigid gooseneck (131X-A22)	5-1/16" (129 mm)	2-1/2" (63 mm)	2-15/16" (74 mm)	B-0199-01 aerator	2.2 GPM	4" Wrist-action	N	
B-1115-132X	Eterna	2-7/8" Swivel/rigid gooseneck (132X-A22)	8-7/8" (225 mm)	5-7/8" (149 mm)	2-7/8" (73 mm)	B-0199-01 aerator	2.2 GPM	Lever	N	
B-1115-132X-02	Eterna	2-7/8" Swivel/rigid gooseneck (132X-A22)	8-7/8" (225 mm)	5-7/8" (149 mm)	2-7/8" (73 mm)	B-0199-01 aerator	2.2 GPM	4" Wrist-action	N	
B-1115-132XN5C4	Eterna	2-7/8" Swivel/rigid gooseneck	8-7/8" (225 mm)	5-7/8" (149 mm)	2-7/8" (73 mm)	B-0199-01-N05 Non-aerated Spray Device	0.5 GPM	4" Wrist-action	N	
B-1115-132XN5CR	Cerama	2-7/8" Swivel/rigid gooseneck	8-7/8" (225 mm)	5-7/8" (149 mm)	2-7/8" (73 mm)	B-0199-01-N05 Non-aerated Spray Device	0.5 GPM	Lever	N	
B-1115-CR	Cerama	6" Swing/rigid nozzle (059X-A22)	5-7/16" (138 mm)	2-5/16" (59 mm)	6" (153 mm)	B-0199-01 aerator	2.2 GPM	Lever	N	
B-1115-CR-LN	Cerama	—	2" (51 mm)	—	—	—	—	Lever	N	Less nozzle
B-1115-CR-LNM	Cerama	—	2" (51 mm)	—	—	—	—	Lever	N	-LN Master carton of 6
B-1115-CR-M	Cerama	6" Swing/rigid nozzle (059X-A22)	5-7/16" (138 mm)	2-5/16" (59 mm)	6" (153 mm)	B-0199-01 aerator	2.2 GPM	Lever	N	B-1115-CR Master carton of 6
B-1115-LN	Eterna	—	2" (51 mm)	—	—	—	—	Lever	N	Less nozzle
B-1115-LNM	Eterna	—	2" (51 mm)	—	—	—	—	Lever	N	-LN Master carton of 6
B-1115-M	Eterna	6" Swing/rigid nozzle (059X-A22)	5-7/16" (137 mm)	2-5/16" (59 mm)	6" (153 mm)	B-0199-01 aerator	2.2 GPM	Lever	N	B-1115 Master carton of 6
B-1115-XS	Eterna	6" Swing/rigid nozzle (059X-A22)	5-7/16" (137 mm)	2-5/16" (59 mm)	6" (153 mm)	B-0199-01 aerator	2.2 GPM	Lever	N	2" extended shanks
B-1116	Eterna	8" Swing/rigid nozzle (060X-A22)	6" (152 mm)	2-7/8" (73 mm)	8" (204 mm)	B-0199-01 aerator	2.2 GPM	Lever	N	
B-1116-M	Eterna	8" Swing/rigid nozzle (060X-A22)	6" (152 mm)	2-7/8" (73 mm)	8" (204 mm)	B-0199-01 aerator	2.2 GPM	Lever	N	Master carton of 6
B-1117	Eterna	10" Swing/rigid nozzle (061X-A22)	6-3/4" (171 mm)	3-9/16" (91 mm)	10" (254 mm)	B-0199-01 aerator	2.2 GPM	Lever	N	

VR Vandal-resistant



**B-1115 Series
Workboard Faucet, 4" Centers**



Chart, cont.



B-1136

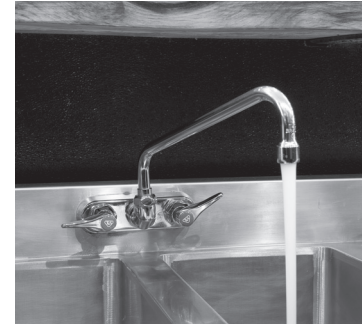

B-1118

MODEL	1/4-Turn CARTRIDGE w/ Cross Flow Prevention	NOZZLE	HEIGHT	CLEARANCE	SPREAD	OUTLET	GPM	HANDLE	VR	NOTES
B-1117-CR	Cerama	10" Swing/rigid nozzle (061X-A22)	6-3/4" (171 mm)	3-9/16" (91 mm)	10" (254 mm)	B-0199-01 aerator	2.2 GPM	Lever	N	
B-1117-CR-M	Cerama	10" Swing/rigid nozzle (061X-A22)	6-3/4" (171 mm)	3-9/16" (91 mm)	10" (254 mm)	B-0199-01 aerator	2.2 GPM	Lever	N	B-1117-CR Master carton of 6
B-1117-M	Eterna	10" Swing/rigid nozzle (061X-A22)	6-3/4" (171 mm)	3-9/16" (91 mm)	10" (254 mm)	B-0199-01 aerator	2.2 GPM	Lever	N	B-1117 Master carton of 6
B-1118	Eterna	12" Swing/rigid nozzle (062X-A22)	7-3/8" (187 mm)	4-1/4" (108 mm)	12" (305 mm)	B-0199-01 aerator	2.2 GPM	Lever	N	
B-1118-M	Eterna	12" Swing/rigid nozzle (062X-A22)	7-3/8" (187 mm)	4-1/4" (108 mm)	12" (305 mm)	B-0199-01 aerator	2.2 GPM	Lever	N	B-1118 Master carton of 6
B-1136	Eterna	18" Double-joint Swing nozzle (068X-A22)	7-1/2" (190 mm)	4-1/4" (108 mm)	18" (457 mm)	B-0199-01 aerator	2.2 GPM	Lever	N	
B-1136-CR	Cerama	18" Double-joint Swing nozzle (068X-A22)	7-1/2" (190 mm)	4-1/4" (108 mm)	18" (457 mm)	B-0199-01 aerator	2.2 GPM	Lever	N	

VR Vandal-resistant

Find Nozzles, Aerators, Goosenecks and Handles in our G-12 Accessories section (ACS).



B-1120 Series Workboard Faucet, 8" Centers

SERIES
1
OUTLETS

- 8" (203 mm) deck mount workboard faucet
- Swing/rigid nozzle
- 2.2 GPM aerator, Series 1 (B-0199-01)
- Quarter-turn cartridges with cross flow prevention
- Chrome plated escutcheon, 10-1/2" (267 mm) long x 2" (51 mm) wide
- 1" (25 mm) long shanks with 1/2"NPT male threads
- Includes (150A) tailpieces and nuts for 1/4" NPT connections



B-1121

MODEL	1/4-Turn CARTRIDGE w/ Cross Flow Prevention	NOZZLE	HEIGHT	CLEARANCE	SPREAD	OUTLET	GPM	HANDLE	VR	NOTES
B-1120	Eterna	6" swing/rigid nozzle (059X-A22)	6-1/8" (156 mm)	3" (76 mm)	6" (153 mm)	B-0199-01 aerator	2.2 GPM	Lever	N	
B-1120-0CS6-WH4	Eterna	6" OCS6 swing/rigid cast spout	3-3/8" (85 mm)	1-3/4" (44 mm)	6" (153 mm)	B-0199-02 aerator	2.2 GPM	4" Wrist-action	N	
B-1120-135X-WH4	Eterna	8-13/16" swing/rigid gooseneck (135X-A22)	13-1/8" (333 mm)	6-3/16" (156 mm)	8-13/16" (223 mm)	B-0199-02 aerator	2.2 GPM	4" Wrist-action	N	
B-1120-CR	Cerama	6" swing/rigid nozzle (059X-A22)	6-1/8" (156 mm)	3" (76 mm)	6" (153 mm)	B-0199-01 aerator	2.2 GPM	Lever	N	
B-1120-CR-LN	Cerama	—	3-1/4" (82 mm)	—	—	—	—	Lever	N	Less nozzle
B-1120-CR-LNM	Cerama	—	3-1/4" (82 mm)	—	—	—	—	Lever	N	-LN Master carton of 6
B-1120-LN	Eterna	—	3-5/16" (84 mm)	—	—	—	—	Lever	N	Less nozzle
B-1120-LN-WH4	Eterna	—	4-15/16" (125 mm)	—	—	—	—	4" Wrist-action	N	Less nozzle
B-1120-LNM	Eterna	—	3-5/16" (84 mm)	—	—	—	—	Lever	N	Less nozzle; -LN Master carton of 6
B-1120-M	Eterna	6" swing/rigid nozzle (059X)	6-1/8" (156 mm)	3" (76 mm)	6" (153 mm)	B-0199-01 aerator	2.2 GPM	Lever	N	B-1120 Master carton of 6
B-1120-QT-WS	Eterna	6" swing/rigid nozzle (059X-A22)	6-1/8" (156 mm)	3" (76 mm)	6" (153 mm)	B-0199-01-WS aerator	1.5 GPM	Lever	N	WaterSense aerator
B-1120-XS	Eterna	6" swing/rigid nozzle (059X-A22)	6-1/8" (156 mm)	3" (76 mm)	6" (153 mm)	B-0199-01 aerator	2.2 GPM	Lever	N	2" extended shanks
B-1120-XS-LN	Eterna	—	3-5/16" (84 mm)	—	—	—	—	Lever	N	Less nozzle; 2" extended shanks
B-1120-XS-LNM	Eterna	—	3-5/16" (84 mm)	—	—	—	—	Lever	N	-XS-LN Master carton of 6
B-1121	Eterna	8" swing/rigid nozzle (060X-A22)	6-3/4" (171 mm)	3-9/16" (91 mm)	8" (204 mm)	B-0199-01 aerator	2.2 GPM	Lever	N	
B-1121-M	Eterna	8" swing/rigid nozzle (060X-A22)	6-3/4" (171 mm)	3-9/16" (91 mm)	8" (204 mm)	B-0199-01 aerator	2.2 GPM	Lever	N	B-1121 Master carton of 6
B-1121-XS	Eterna	8" swing/rigid nozzle (060X-A22)	6-3/4" (171 mm)	3-9/16" (91 mm)	8" (204 mm)	B-0199-01 aerator	2.2 GPM	Lever	N	2" extended shanks
B-1122	Eterna	10" swing/rigid nozzle (061X-A22)	7-7/16" (189 mm)	4-5/16" (109 mm)	10" (254 mm)	B-0199-01 aerator	2.2 GPM	Lever	N	

VR Vandal-resistant



B-1125 Workboard Faucet, 8" Centers

SERIES
1
OUTLETS

- 8" (203 mm) wall mount workboard faucet
- Swing/rigid nozzle
- 2.2 GPM aerator, Series 1 (B-0199-01)
- Quarter-turn cartridges with cross flow prevention
- Chrome plated escutcheon, 10-1/2" (267 mm) long x 2" (51 mm) wide
- 1" (25 mm) long shanks with 1/2" NPT male threads
- Includes (150A) tailpieces and nuts for 1/4" NPT connections



B-1128-XS

Note: Order the B-1100-K Elbow kit separately; includes (2) 1/2" NPT male x female short els

MODEL	1/4-Turn CARTRIDGE w/ Cross Flow Prevention	NOZZLE	HEIGHT	CLEARANCE	SPREAD	OUTLET	GPM	HANDLE	VR	NOTES
B-1125	Eterna	6" Swing/rigid nozzle (059X-A22)	5-7/16" (137 mm)	2-5/16" (58 mm)	6" (153 mm)	B-0199-01 aerator	2.2 GPM	Lever	N	
B-1125-CR	Cerama	6" Swing/rigid nozzle (059X-A22)	5-7/16" (137 mm)	2-5/16" (58 mm)	6" (153 mm)	B-0199-01 aerator	2.2 GPM	Lever	N	
B-1125-CR-LN	Cerama	—	2" (51 mm)	—	—	—	—	Lever	N	Less nozzle
B-1125-CR-LNM	Cerama	—	2" (51 mm)	—	—	—	—	Lever		-LN Master carton of 6
B-1125-LN	Eterna	—	2" (51 mm)	—	—	—	—	Lever	N	Less nozzle
B-1125-LNM	Eterna	—	2" (51 mm)	—	—	—	—	Lever	N	-LN Master carton of 6
B-1125-M	Eterna	6" Swing/rigid nozzle (059X-A22)	5-7/16" (137 mm)	2-5/16" (58 mm)	6" (153 mm)	B-0199-01 aerator	2.2 GPM	Lever	N	B-1125 Master carton of 6
B-1125-XS	Eterna	6" Swing/rigid nozzle (059X-A22)	5-7/16" (137 mm)	2-5/8" (66 mm)	6" (153 mm)	B-0199-01 aerator	2.2 GPM	Lever	N	2" extended shanks
B-1125-XS-HM	Eterna	3" Swivel/rigid gooseneck	5-1/16" (129 mm)	2-1/2" (63 mm)	2-15/16" (74 mm)	B-0199-29VR VR laminar flow device	1.5 GPM	4" Wrist-action	Y	Swivel to rigid option; VR aerator key; inc. (2) B-1100-K 1/2" NPT male x female short els
B-1126	Eterna	8" Swing/rigid nozzle (060X-A22)	6" (152 mm)	2-7/8" (73 mm)	8" (204 mm)	B-0199-01 aerator	2.2 GPM	Lever	N	
B-1126-M	Eterna	8" Swing/rigid nozzle (060X-A22)	6" (152 mm)	2-7/8" (73 mm)	8" (204 mm)	B-0199-01 aerator	2.2 GPM	Lever	N	B-1126 Master carton of 6
B-1126-XS	Eterna	8" Swing/rigid nozzle (060X-A22)	6" (152 mm)	2-7/8" (73 mm)	8" (204 mm)	B-0199-01 aerator	2.2 GPM	Lever	N	2" extended shanks
B-1127	Eterna	10" Swing/rigid nozzle (061X-A22)	6-3/4" (171 mm)	3-9/16" (91 mm)	10" (254 mm)	B-0199-01 aerator	2.2 GPM	Lever	N	
B-1127-M	Eterna	10" Swing/rigid nozzle (061X-A22)	6-3/4" (171 mm)	3-9/16" (91 mm)	10" (254 mm)	B-0199-01 aerator	2.2 GPM	Lever	N	B-1127 Master carton of 6
B-1128	Eterna	12" Swing/rigid nozzle (062X-A22)	7-3/8" (187 mm)	4-1/4" (107 mm)	12" (305 mm)	B-0199-01 aerator	2.2 GPM	Lever	N	
B-1128-M	Eterna	12" Swing/rigid nozzle (062X-A22)	7-3/8" (187 mm)	4-1/4" (107 mm)	12" (305 mm)	B-0199-01 aerator	2.2 GPM	Lever	N	B-1128 Master carton of 6

VR Vandal-resistant



B-1146 Workboard Faucet, 4" Centers



- 4" (102 mm) wall mount workboard faucet
- Swing/rigid gooseneck
- 2.2 GPM aerator, Series 1 (B-0199-01)
- Quarter-turn cartridges with cross flow prevention
- Chrome plated escutcheon, 6-1/2" (165 mm) long x 2" (51 mm) wide
- 1" (25 mm) long shanks with 1/2" NPT male threads
- Includes (150A) tailpieces and nuts for 1/4" NPT connections

Note: Order the B-1100-K Elbow kit separately; includes (2) 1/2" NPT male x female short els



MODEL	1/4-Turn CARTRIDGE w/ Cross Flow Prevention	GOOSENECK	HEIGHT	CLEARANCE	SPREAD	OUTLET	GPM	HANDLE	VR	NOTES
B-1146	Eterna	5-11/16" Swivel/rigid gooseneck (133X-A22)	10-11/16" (271 mm)	6-1/4" (158 mm)	5-3/4" (145 mm)	B-0199-01 aerator	2.2 GPM	Lever	N	
B-1146-01	Eterna	2-15/16" Swivel/rigid gooseneck (131X-A22)	5-1/16" (129 mm)	2-1/2" (64 mm)	2-15/16" (74 mm)	B-0199-01 aerator	2.2 GPM	Lever	N	
B-1146-01-CR	Cerama	2-15/16" Swivel/rigid gooseneck (131X-A22)	5-1/16" (129 mm)	2-1/2" (64 mm)	2-15/16" (74 mm)	B-0199-01 aerator	2.2 GPM	Lever	N	
B-1146-01-WS	Eterna	2-15/16" Swivel/rigid gooseneck (131X-A22)	5-1/16" (128 mm)	2-1/2" (64 mm)	2-15/16" (74 mm)	B-0199-01-WS aerator	1.5 GPM	Lever	N	WaterSense aerator
B-1146-01A-W4EK	Eterna	2-15/16" Swivel/rigid gooseneck (131X-A22)	5-1/16" (128 mm)	2-1/2" (64 mm)	2-15/16" (74 mm)	B-0199-01 aerator	2.2 GPM	4" Wrist-action	N	Includes (2) B-1100-K 1/2" NPT male x female short els
B-1146-02A	Eterna	4-3/8" Swivel/rigid gooseneck (179X-A22)	9-9/16" (243 mm)	5-15/16" (151 mm)	4-3/8" (111 mm)	B-0199-01 aerator	2.2 GPM	Lever	N	
B-1146-02A-CR	Cerama	Swivel/rigid gooseneck (179X-A22)	9-9/16" (242 mm)	5-15/16" (151 mm)	4-3/8" (111 mm)	B-0199-01 aerator	2.2 GPM	Lever	N	
B-1146-02A-WH4	Eterna	4-3/8" Swivel/rigid gooseneck (179X-A22)	9-9/16" (243 mm)	5-15/16" (151 mm)	4-3/8" (111 mm)	B-0199-01 aerator	2.2 GPM	4" Wrist-action	N	
B-1146-04	Eterna	5-3/4" Swivel/rigid gooseneck (133X-A22)	10-11/16" (271 mm)	6-1/4" (158 mm)	5-3/4" (145 mm)	B-0199-01 aerator	2.2 GPM	4" Wrist-action	N	
B-1146-04-CR	Cerama	5-3/4" Swivel/rigid gooseneck (133X-A22)	10-11/16" (271 mm)	6-1/4" (158 mm)	5-3/4" (145 mm)	B-0199-01 aerator	2.2 GPM	4" Wrist-action	N	
B-1146-04-WS	Eterna	5-3/4" Swivel/rigid gooseneck (133X-A15)	10-11/16" (270 mm)	6-1/4" (158 mm)	5-3/4" (145 mm)	B-0199-01-WS aerator	1.5 GPM	Lever	N	WaterSense aerator
B-1146-2-V12-CR	Cerama	Swivel/rigid gooseneck (179X-V12)	9-9/16" (243 mm)	5-15/16" (151 mm)	4-3/8" (111 mm)	B-0199-06-F12 VR aerator	1.2 GPM	Lever	N	
B-1146-WS	Eterna	5-3/4" Swivel/rigid gooseneck (133X-A15)	10-11/16" (270 mm)	6-1/4" (158 mm)	5-3/4" (145 mm)	B-0199-01-WS aerator	1.5 GPM	Lever	N	WaterSense aerator
B-1146-XS	Eterna	5-3/4" Swivel gooseneck (133X-A22)	10-11/16" (270 mm)	6-1/4" (158 mm)	5-3/4" (145 mm)	B-0199-01 aerator	2.2 GPM	Lever	N	2" extended shanks

VR Vandal-resistant

Find Nozzles, Aerators, Goosenecks and Handles in our G-12 Accessories section (ACS)

B-1142
Workboard Faucet, 8" Centers



- 8" (203 mm) deck mount workboard faucet
- Swivel/rigid gooseneck
- 2.2 GPM aerator, Series 1 (B-0199-01)
- Cartridges with cross flow prevention
- Lever handles with color coded indexes
- Chrome plated escutcheon, 10-1/2" (267 mm) long x 2" (51 mm) wide
- 1" (25 mm) long shanks with 1/2" NPT male threads
- Includes (150A) tailpieces and nuts for 1/4" NPT connections



B-1142-04 Same as B-1142 except with 4" wrist action handles
B-1142-XS Same as B-1142 except with 2" (51 mm) extended shanks
B-1142-VF05 Same as B-1142 except with 0.5 GPM vandal-resistant non-aerated spray device

B-1148
Workboard Faucet



- 8" (203 mm) deck mount workboard faucet
- High rise swivel/rigid gooseneck (B-2403)
- 2.2 GPM aerator, Series 1 (B-0199-01)
- Cartridges with cross flow prevention
- Lever handles with color coded indexes
- Chrome plated escutcheon, 10-1/2" (267 mm) long x 2" (51 mm) wide
- 1" (25 mm) long shanks with 1/2" NPT male threads
- Includes (150A) tailpieces and nuts for 1/4" NPT connections



B-1149 Same as B-1148 except with 4" (102 mm) wrist-action handles (B-WH4)

Elevated Vacuum Breaker Assemblies

B-0455
Vacuum Breaker Assembly

- 6" (152 mm) C/C mounting vacuum breaker unit
- 1/2" NPT male connections
- Angled adjustable height slip flanges
- Pipes must be held rigid under sink with connection fitting, brace, etc.

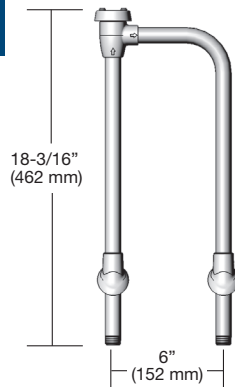

B-0455-04
Vacuum Breaker Assembly

- 4" (102 mm) C/C mounting vacuum breaker unit
- 1/2" NPT male connections
- Angled adjustable height slip flanges
- Pipes must be held rigid under sink with connection fitting, brace, etc.

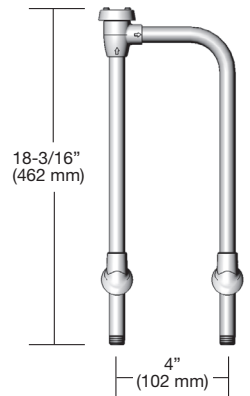

B-0455-04-963VB Same as B-0455-04 except with B-0963 continuous pressure vacuum breaker

B-0456
Vacuum Breaker Assembly

- 6" (152 mm) C/C mounting vacuum breaker unit
- 1/2" NPT male connections
- Adjustable 2" (51 mm) diameter flanges
- Pipes must be held rigid under sink with connection fitting, brace, etc.

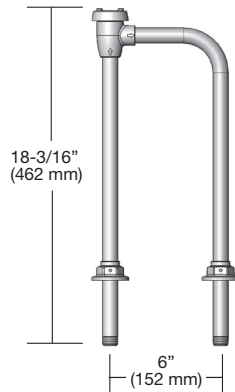

B-0456-04
Vacuum Breaker Assembly

- 4" (102 mm) C/C mounting vacuum breaker unit
- 1/2" NPT male connections
- Adjustable 2" (51 mm) diameter flanges
- Factory pre-assembled
- Pipes must be held rigid under sink with connection fitting, brace, etc.

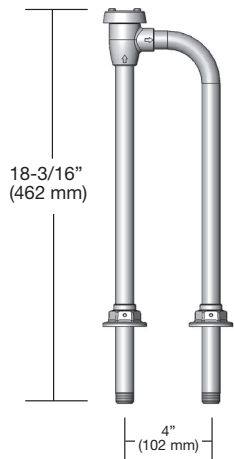

B-0456-04-963VB Same as B-0456-04 except with B-0963 continuous pressure vacuum breaker



B-1156 Workboard Faucet

SERIES
2
OUTLETS

- 4" (102 mm) wall mount workboard faucet
- 7-7/8" (201 mm) swing/rigid nozzle (002878-40)
- 2.2 GPM aerator, Series 2 (B-0199-02)
- Quarter-turn cartridges with cross flow prevention
- Lever handles with color coded indexes
- Chrome plated escutcheon, 6-1/2" (165 mm) long x 2" (51 mm) wide
- Positive diverter valve assembly
- Protective flange (B-KF) for sheet metal up to 1/8" (3 mm) thick
- Spray valve (002857-40) with 48" (1219 mm) flexible stainless steel hose (013E-48)
- 1" (25 mm) long shanks with 1/2" NPT male threads
- Includes (150A) tailpieces and nuts for 1/4" NPT connections

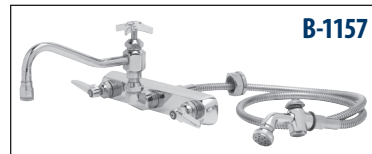

MODEL	1/4-Turn CARTRIDGE w/ Cross Flow Prevention	NOZZLE	HEIGHT	CLEARANCE	SPREAD	OUTLET	GPM	HANDLE	VR	NOTES
B-1156	Eterna	8" Swing/rigid nozzle (002878-40)	5-7/16" (137 mm)	1-1/16" (27 mm)	7-7/8" (201 mm)	B-0199-02 Aerator	–	Lever	N	4" centers; 6-1/2" long escutcheon
B-1156-CR	Cerama	8" Swing/rigid nozzle (002878-40)	5-7/16" (137 mm)	1-1/16" (27 mm)	7-7/8" (201 mm)	B-0199-02 Aerator	–	Lever	N	4" centers; 6-1/2" long escutcheon
B-1157	Eterna	8" Swing/rigid nozzle (002878-40)	5-7/16" (137 mm)	1-1/16" (27 mm)	7-7/8" (201 mm)	B-0199-02 Aerator	–	Lever	N	8" centers; 10-1/2" long escutcheon
B-1157-12	Eterna	12" Swing nozzle	6-1/2" (165 mm)	3-1/8" (79 mm)	11-7/8" (302 mm)	B-0199-02 Aerator	–	Lever	N	8" centers; 10-1/2" long escutcheon; 72" long flex. stainless steel hose

VR Vandal-resistant



B-1171 Workboard Faucet



- 4" (102 mm) deck mount workboard faucet
- 8" (204 mm) swing/rigid nozzle
- 2.2 GPM aerator, Series 1 (B-0199-01)
- Quarter-turn cartridges with cross flow prevention
- Lever handles with color coded indexes
- Chrome plated escutcheon, 6-1/2" (165 mm) long x 2" (51 mm) wide
- Built-in diverter valve assembly
- Protective flange (B-KF) for sheet metal up to 1/8" (3 mm) thick
- Sidespray with 4 ft. (1.2 m) reinforced vinyl hose and hose guide
- 1" (25 mm) long shanks with 1/2" NPT male threads
- Includes (150A) tailpieces and nuts for 1/4" NPT connections



MODEL	1/4-Turn CARTRIDGE w/ Cross Flow Prevention	NOZZLE	HEIGHT	CLEARANCE	SPREAD	OUTLET	GPM	HANDLE	VR	NOTES
B-1171	Eterna	8" Swing nozzle	7-7/16" (190 mm)	4-5/16" (110 mm)	8" (204 mm)	B-0199-01 Aerator	2.2 GPM	Lever	N	4" centers; 6-1/2" long escutcheon; 4 ft. vinyl hose
B-1171-01	Eterna	16" Swing nozzle	10-5/16" (263 mm)	7-3/16" (183 mm)	16" (407 mm)	B-0199-01 Aerator	2.2 GPM	Lever	N	4" centers; Spray valve with rosespray outlet (002857-40) w/48" S/S hose (013E-48H)
B-1171-07	Eterna	8" Swing nozzle	7-7/16" (190 mm)	4-5/16" (110 mm)	8" (204 mm)	B-0199-01 Aerator	2.2 GPM	Lever	N	4" centers; 6-1/2" long escutcheon; 7 ft. vinyl hose
B-1171-CR	Cerama	8" Swing nozzle	7-7/16" (190 mm)	4-5/16" (110 mm)	8" (204 mm)	B-0199-01 Aerator	2.2 GPM	Lever	N	4" centers; 6-1/2" long escutcheon; 4 ft. vinyl hose
B-1172	Eterna	8" Swing nozzle	7-7/16" (190 mm)	4-5/16" (110 mm)	8" (204 mm)	B-0199-01 Aerator	2.2 GPM	Lever	N	8" centers; 10-1/2" long escutcheon; 4 ft. vinyl hose
B-1172-07	Eterna	8" Swing nozzle	7-7/16" (190 mm)	4-5/16" (110 mm)	8" (204 mm)	B-0199-01 Aerator	2.2 GPM	Lever	N	8" centers; 10-1/2" long escutcheon; 7 ft. vinyl hose
B-1172-07-133X	Eterna	5-3/4" Swivel gooseneck	12-1/8" (308 mm)	7-11/16" (195 mm)	5-3/4" (145 mm)	B-0199-01 Aerator	2.2 GPM	Lever	N	8" centers; 10-1/2" long escutcheon; 7 ft. vinyl hose
B-1172-07-WH4	Eterna	5-3/4" Swivel gooseneck	12-1/8" (308 mm)	7-11/16" (195 mm)	5-3/4" (145 mm)	B-0199-01 Aerator	2.2 GPM	4" Wrist-action	N	8" centers; 10-1/2" long escutcheon; 7 ft. vinyl hose
B-1172-96-135X	Eterna	8-13/16" Swivel gooseneck	13-3/4" (349 mm)	6-3/4" (171 mm)	8-13/16" (224 mm)	B-0199-02 aerator	2.2 GPM	Lever	N	8" centers; EB-0107 spray valve on EB-0096-H 96" hose; 2019 DOE PRSV-non-compliant
B-1172-CR	Cerama	8" Swivel nozzle	7-7/16" (190 mm)	4-5/16" (110 mm)	8" (204 mm)	B-0199-01 Aerator	2.2 GPM	Lever	N	8" centers; 10-1/2" long escutcheon; 4 ft. vinyl hose
B-1172-TS	Eterna	8-13/16" Swivel gooseneck	13-3/4" (349 mm)	6-3/4" (171 mm)	8-13/16" (224 mm)	B-0199-02 aerator	2.2 GPM	Lever	N	8" centers; 10-1/2" long escutcheon; 4 ft. vinyl hose
B-1173	Eterna	High-rise Swivel gooseneck	11-5/16" (288 mm)	9-7/16" (240 mm)	7-7/8" (200 mm)	B-0199-01 aerator	2.2 GPM	Lever	N	8" centers; 10-1/2" long escutcheon; 4 ft. vinyl hose
B-1173-101-48H	Eterna	High-rise Swivel gooseneck	11-5/16" (288 mm)	9-7/16" (240 mm)	7-7/8" (200 mm)	B-0199-01 aerator	2.2 GPM	Lever	N	8" centers; spray valve with rosespray outlet (002857-40) w/48" S/S hose (013E-48H)

VR Vandal-resistant



B-1177 Workboard Faucet

SERIES
2
OUTLETS

- 4" (102 mm) deck mount workboard faucet
- 8-5/8" (218 mm) rigid vacuum breaker nozzle
- 2.2 GPM aerator, Series 2 (B-0199-02)
- Quarter-turn cartridges with cross flow prevention
- Lever handles with color coded indexes
- Chrome plated escutcheon, 6-1/2" (165 mm) long x 2" (51 mm) wide
- Built-in diverter valve assembly
- Protective flange (B-KF) for sheet metal up to 1/8" (3 mm) thick
- Sidespray with 4 ft. (1.2 m) reinforced vinyl hose and hose guide
- 1" (25 mm) long shanks with 1/2" NPT male threads
- Includes (150A) tailpieces and nuts for 1/4" NPT connections



B-1193 Workboard Faucet

2019 DOE PRSV-Non-Compliant

- 4" (102 mm) wall mount workboard faucet
- B-0968 3/8" NPT vacuum breaker with adapter outlet
- Quarter-turn cartridges with cross flow prevention
- Lever handles with color coded indexes
- Chrome plated escutcheon, 6-1/2" (165 mm) long x 2" (51 mm) wide
- EB-0107 High-flow spray valve with 72" (1219 mm) flexible stainless steel hose (EB-0072-H)
- Built-in diverter valve assembly
- 1" (25 mm) long shanks with 1/2" NPT male threads
- Includes (150A) tailpieces and nuts for 1/4" NPT connections



B-2346 Workboard Faucet

2019 DOE PRSV-Non-Compliant

- 8" (203 mm) deck-mount workboard faucet
- Vacuum breaker gooseneck with garden hose male outlet (B-0972)
- Quarter-turn cartridges with cross flow prevention
- 4" wrist action handles with color coded indexes (B-WH4)
- Chrome plated escutcheon, 10-1/2" (267 mm) long x 2" (51 mm) wide
- High-flow angled spray valve (EB-0107-035)
- 5 ft. (1.5 m) flexible stainless steel hose (EB-0060-H)
- Built-in diverter valve assembly
- Protective flange (B-KF) for sheet metal up to 1/8" (3 mm) thick
- 1" (25 mm) long shanks with 1/2" NPSM male inlets
- Includes (150A) tailpieces and nuts for 1/4" NPT connection





Waste Valves with Twist Handle or Lever Handle

Features:

- All models are equipped with an overflow outlet and cap
- "-01" models come furnished with a complete overflow assembly (B-3999-OF)
- Models available with a conversion adapter that reduces a 2" drain outlet to a 1½" outlet
- Master Packs available

B-3940
Waste Valve with Twist Handle

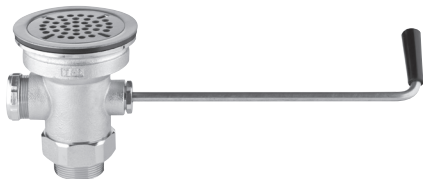

B-3960
Waste Valve with Lever Handle



Twist Models

MODEL	Sink Opening	Drain Outlet (NPT)	Overflow Assembly
B-3940	3"	1½" or 2" male	Optional
B-3940-01*	3"	1½" or 2" male	Included
B-3942	3"	2" male / 1½" female	Optional
B-3942-01*	3"	2" male / 1½" female	Included
B-3950	3½"	1½" or 2" male	Optional
B-3950-01*	3½"	1½" or 2" male	Included
B-3952	3½"	2" male / 1½" female	Optional
B-3952-01*	3½"	2" male / 1½" female	Included

* "-01" models include an overflow assembly

Lever Models

MODEL	Sink Opening	Drain Outlet (NPT)	Overflow Assembly
B-3960	3"	1½" or 2" male	Optional
B-3960-01*	3"	1½" or 2" male	Included
B-3962	3"	2" male / 1½" female	Optional
B-3962-01*	3"	2" male / 1½" female	Included
B-3970	3½"	1½" or 2" male	Optional
B-3970-01*	3½"	1½" or 2" male	Included
B-3972	3½"	2" male / 1½" female	Optional
B-3972-01*	3½"	2" male / 1½" female	Included

* "-01" models include an overflow assembly

- Valve bodies come standard with a 2" NPT male/1½" NPT female outlet
- Also available with adapter that allows for either a 1½" NPT male or 2" NPT male outlet (B-3945)
- 3" (76 mm) or 3½" (89 mm) sink opening applications



Waste Valves with Twist Handle or Lever Handle

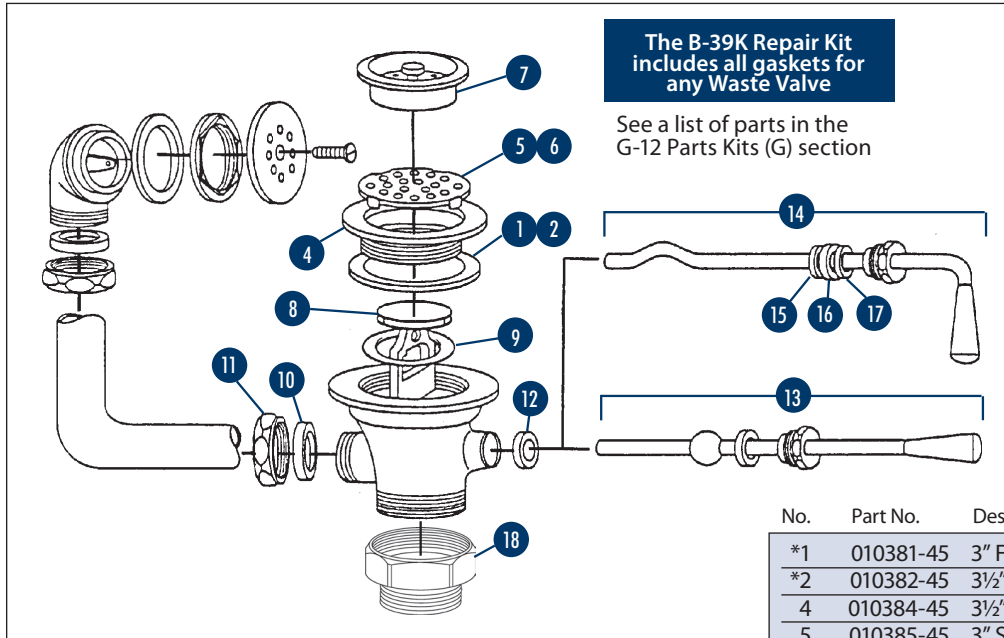

No.	Part No.	Description
*1	010381-45	3" Flange Gasket
*2	010382-45	3 1/2" Flange Gasket
4	010384-45	3 1/2" Flange Flange
5	010385-45	3" Strainer, Flat
6	010386-45	3 1/2" Strainer, Flat
7	010387-45	3 1/2" Crumb Cup Strainer
8	010388-45	Plunger
*9	010389-45	'O'-Ring
*10	010390-45	Coupling Washer
11	010391-45	Coupling Nut
*12	010392-45	Drain Rod Bushing
13	010394-45	Lever Handle Assembly
14	010393-45	Twist Handle Assembly
*15		Twist Handle C-Ring
*16		Twist Handle Washer
*17		Twist Handle 'O'-Ring
18	B-3945	Adapter (converts 2" NPT male to 1 1/2" NPT male)

* These parts are included in the B-39K Repair Kit; see the Parts Kits (G) section

Waste Valve Accessories

Flat Strainer

• Flat Strainers with four (4) mounting lugs:

3" (76 mm)	010385-45
3-1/2" (89 mm)	010386-45
3-1/2" (89 mm), Vandal-resistant	010386-45VR

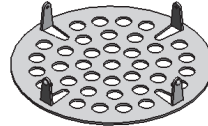

Twist Handle Assemblies

• Twist waste valve handle assembly in three lengths:

9" (229 mm)	010393-45XS
13-1/2" (343 mm)	010393-45
17-1/2" (445 mm)	010393-45XL

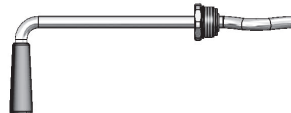

Lever Handle Assemblies

• Lever waste valve handle assembly in two lengths:

8" (203 mm)	010394-45XS
12-1/2" (318 mm)	010394-45



B-3999-OF Overflow Assembly

- Available for all waste valve models
- 1-1/4" dia. tube
- 14-5/16" x 18" elbow
- All "-01" models include the overflow assembly
For ex.: B-3940-01
- Tube only: (011355-45)
- Head only: (011356-45)

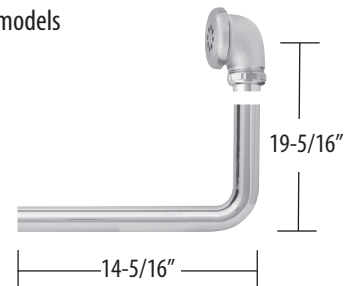

B-3999-05XL Same as B-3999-OF except with extra long 24" x 24" elbow tube (011355-45XL)

Waste Valves with Twist Handle

- All twist and lever models are equipped with an overflow outlet and cap
- “-01” models come furnished with a complete overflow assembly (B-3999-OF)
- Models available with a conversion adapter that reduces a 2” NPT male drain outlet to a 1½” NPT male outlet (B-3945)
- Master Packs available

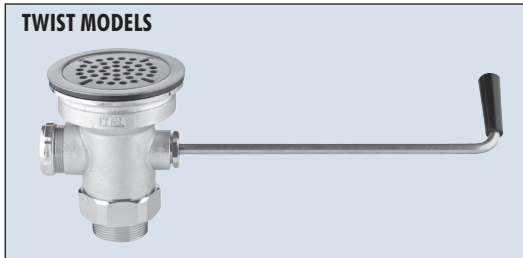

- Twist handle with heat-resistant plastic grip
- Other handle lengths available (see page C47)

TWIST MODELS	SINK OPENING	DRAIN OUTLET (NPT)	OVERFLOW ASSEMBLY	HANDLE	NOTES
B-3940	3"	1-1/2" male or 2" male	Optional	Standard twist, 12-1/4" (311 mm)	
B-3940-M	3"	1-1/2" male or 2" male	Optional	Standard twist, 12-1/4" (311 mm)	B-3940 Master carton of 6
B-3940-XL	3"	1-1/2" male or 2" male	Optional	Long twist, 16-1/4" (413 mm)	
B-3940-XS	3"	1-1/2" male or 2" male	Optional	Short twist, 7-13/16" (198 mm)	
B-3940-01	3"	1-1/2" male or 2" male	Included	Standard twist, 12-1/4" (311 mm)	
B-3940-01-XS	3"	1-1/2" male or 2" male	Included	Short twist, 7-13/16" (198 mm)	
B-3940-01M	3"	1-1/2" male or 2" male	Included	Standard twist, 12-1/4" (311 mm)	B-3940-01 Master carton of 6
B-3942	3"	2" male/1-1/2" female	Optional	Standard twist, 12-1/4" (311 mm)	
B-3942-XL	3"	2" male/1-1/2" female	Optional	Long twist, 16-1/4" (413 mm)	
B-3942-XS	3"	2" male/1-1/2" female	Optional	Short twist, 7-13/16" (198 mm)	
B-3942-01	3"	2" male/1-1/2" female	Included	Standard twist, 12-1/4" (311 mm)	
B-3942-01-XS	3"	2" male/1-1/2" female	Included	Short twist, 7-13/16" (198 mm)	
B-3950	3-1/2"	1-1/2" male or 2" male	Optional	Standard twist, 12-1/4" (311 mm)	
B-3950-M	3-1/2"	1-1/2" male or 2" male	Optional	Standard twist, 12-1/4" (311 mm)	B-3950 Master carton of 6
B-3950-SB	3-1/2"	1-1/2" male or 2" male	Optional	Standard twist, 12-1/4" (311 mm)	Includes removable strainer basket
B-3950-VR	3-1/2"	1-1/2" male or 2" male	Optional	Standard twist, 12-1/4" (311 mm)	Includes vandal-resistant flat strainer
B-3950-XL	3-1/2"	1-1/2" male or 2" male	Optional	Long twist, 16-1/4" (413 mm)	
B-3950-XS	3-1/2"	1-1/2" male or 2" male	Optional	Short twist, 7-13/16" (198 mm)	
B-3950-01	3-1/2"	1-1/2" male or 2" male	Included	Standard twist, 12-1/4" (311 mm)	
B-3950-01-M	3-1/2"	1-1/2" male or 2" male	Included	Standard twist, 12-1/4" (311 mm)	B-3950 Master carton of 6
B-3950-01-M12	3-1/2"	1-1/2" male or 2" male	Included	Standard twist, 12-1/4" (311 mm)	B-3950 Master carton of 12
B-3950-01-SB	3-1/2"	2" male/1-1/2" female	Included	Standard twist, 12-1/4" (311 mm)	Includes removable strainer basket
B-3952	3-1/2"	2" male/1-1/2" female	Optional	Standard twist, 12-1/4" (311 mm)	
B-3952-VR	3-1/2"	2" male/1-1/2" female	Optional	Standard twist, 12-1/4" (311 mm)	Includes vandal-resistant flat strainer
B-3952-XL	3-1/2"	2" male/1-1/2" female	Optional	Long twist, 16-1/4" (413 mm)	
B-3952-XS	3-1/2"	2" male/1-1/2" female	Optional	Short twist, 7-13/16" (198 mm)	
B-3952-01	3-1/2"	2" male/1-1/2" female	Included	Standard twist, 12-1/4" (311 mm)	

Waste Valves with Lever Handle

- All twist and lever models are equipped with an overflow outlet and cap
- "-01" models come furnished with a complete overflow assembly (B-3999-OF)
- Models available with a conversion adapter that reduces a 2" NPT male drain outlet to a 1½" NPT male outlet (B-3945)
- Master Packs available

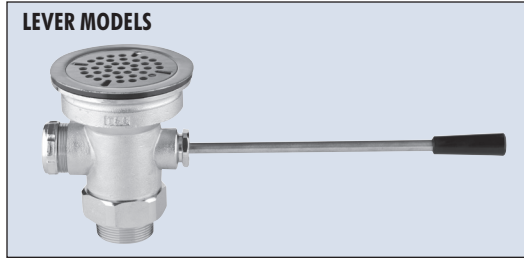

- Lever handle with heat-resistant plastic grip
- Other handle lengths available (see page C47)

LEVER MODELS	SINK OPENING	DRAIN OUTLET (NPT)	OVERFLOW ASSEMBLY	HANDLE	NOTES
B-3960	3"	1-1/2" male or 2" male	Optional	Standard lever, 12-1/8" (308 mm)	
B-3960-XS	3"	1-1/2" male or 2" male	Optional	Short lever, 7-5/8" (194 mm)	
B-3960-01	3"	1-1/2" male or 2" male	Included	Standard lever, 12-1/8" (308 mm)	
B-3960-01-XS	3"	1-1/2" male or 2" male	Included	Short lever, 7-5/8" (194 mm)	
B-3962	3"	2" male/1-1/2" female	Optional	Standard lever, 12-1/8" (308 mm)	
B-3962-01	3"	2" male/1-1/2" female	Included	Standard lever, 12-1/8" (308 mm)	
B-3962-01-XS	3"	2" male/1-1/2" female	Included	Short lever, 7-5/8" (194 mm)	
B-3970	3-1/2"	1-1/2" male or 2" male	Optional	Standard lever, 12-1/8" (308 mm)	
B-3970-VR	3-1/2"	1-1/2" male or 2" male	Optional	Standard lever, 12-1/8" (308 mm)	Includes vandal-resistant flat strainer
B-3970-XS	3-1/2"	1-1/2" male or 2" male	Optional	Short lever, 7-5/8" (194 mm)	
B-3970-01	3-1/2"	1-1/2" male or 2" male	Included	Standard lever, 12-1/8" (308 mm)	
B-3970-01-XS	3-1/2"	1-1/2" male or 2" male	Included	Short lever, 7-5/8" (194 mm)	
B-3972	3-1/2"	2" male/1-1/2" female	Optional	Standard lever, 12-1/8" (308 mm)	
B-3972-VR	3-1/2"	2" male/1-1/2" female	Optional	Standard lever, 12-1/8" (308 mm)	Includes vandal-resistant flat strainer
B-3972-XS	3-1/2"	2" male/1-1/2" female	Optional	Short lever, 7-5/8" (194 mm)	
B-3972-01	3-1/2"	2" male/1-1/2" female	Included	Standard lever, 12-1/8" (308 mm)	
B-3972-01-XS	3-1/2"	2" male/1-1/2" female	Included	Short lever, 7-5/8" (194 mm)	

Modular Waste Valves

Premium Modular Waste Valves have been designed to exceed in the most demanding applications and maintain the quality and reliability you have come to expect from T&S.

Features include:



- Modular design for easy installation and maintenance
- Large drain opening to accommodate high-volume applications
- Push-pull valve activation with rugged handle to endure extreme abuse
- Unique installation tool included to make installation easy
- Handle extension kits available
- Removable snap-in strainer
- Lifetime warranty
- "-01" models include an overflow assembly

MODULAR WASTE VALVE MODELS	SINK OPENING	DRAIN OUTLET	OVERFLOW TUBE / HEAD ASSEMBLY	MODEL HANDLE LENGTH (From Drain Center Line)	RECOMMENDED SINK LENGTH (Front to back)
B-3990	3-1/2"	1-1/2" NPT male or 2" NPT male	Optional	Standard 5-3/4" closed; 8-5/8" open	18" to 20"
B-3990-3X	3-1/2"	1-1/2" NPT male or 2" NPT male	Optional	3" extension kit 8-3/4" closed; 11-5/8" open	20" to 24"
B-3990-5X	3-1/2"	1-1/2" NPT male or 2" NPT male	Optional	5" extension kit 10-3/4" closed; 13-5/8" open	28"
B-3990-BSP	3-1/2"	1-1/2" BSP male or 2" NPT male	Optional	Standard 5-3/4" closed; 8-5/8" open	18" to 20"
B-3990-BSP-3X	3-1/2"	1-1/2" BSP male or 2" NPT male	Optional	3" extension kit 8-3/4" closed; 11-5/8" open	20" to 24"
B-3990-BSP-5X	3-1/2"	1-1/2" BSP male or 2" NPT male	Optional	5" extension kit 10-3/4" closed; 13-5/8" open	28"
B-3992	3-1/2"	2" NPT male / 1-1/2" NPT female	Optional	Standard 5-3/4" closed; 8-5/8" open	18" to 20"
B-3992-3X	3-1/2"	2" NPT male / 1-1/2" NPT female	Optional	3" extension kit 8-3/4" closed; 11-5/8" open	20" to 24"
B-3992-5X	3-1/2"	2" NPT male / 1-1/2" NPT female	Optional	5" extension kit 10-3/4" closed; 13-5/8" open	28"
B-3990-01	3-1/2"	1-1/2" NPT male or 2" NPT male	Included	Standard 5-3/4" closed; 8-5/8" open	18" to 20"
B-3990-01-3X	3-1/2"	1-1/2" NPT male or 2" NPT male	Included	3" extension kit 8-3/4" closed; 11-5/8" open	20" to 24"
B-3990-01-5X	3-1/2"	1-1/2" NPT male or 2" NPT male	Included	5" extension kit 10-3/4" closed; 13-5/8" open	28"
B-3992-01	3-1/2"	2" NPT male / 1-1/2" NPT female	Included	Standard 5-3/4" closed; 8-5/8" open	18" to 20"
B-3992-01-3X	3-1/2"	2" NPT male / 1-1/2" NPT female	Included	3" extension kit 8-3/4" closed; 11-5/8" open	20" to 24"
B-3992-01-5X	3-1/2"	2" NPT male / 1-1/2" NPT female	Included	5" extension kit 10-3/4" closed; 13-5/8" open	28"

Modular Waste Valves

All our Modular Waste Valves can be modified with 3" or 5" handle extensions to accommodate your sink measurements and preferences.

- Refer to the chart below for optional or recommended use of handle extensions
- Refer to the illustrations below for specific measurements related to sink length and recommended handle extensions

B-3990-3KIT 3" Handle Extension Kit

- Includes three (3) 3" extension rods and a capsule of Loctite 222
- Extends Modular Waste Valve handles by 3"

B-3990-5KIT 5" Handle Extension Kit

- Includes three (3) 5" extension rods and a capsule of Loctite 222
- Extends Modular Waste Valve handles by 5"

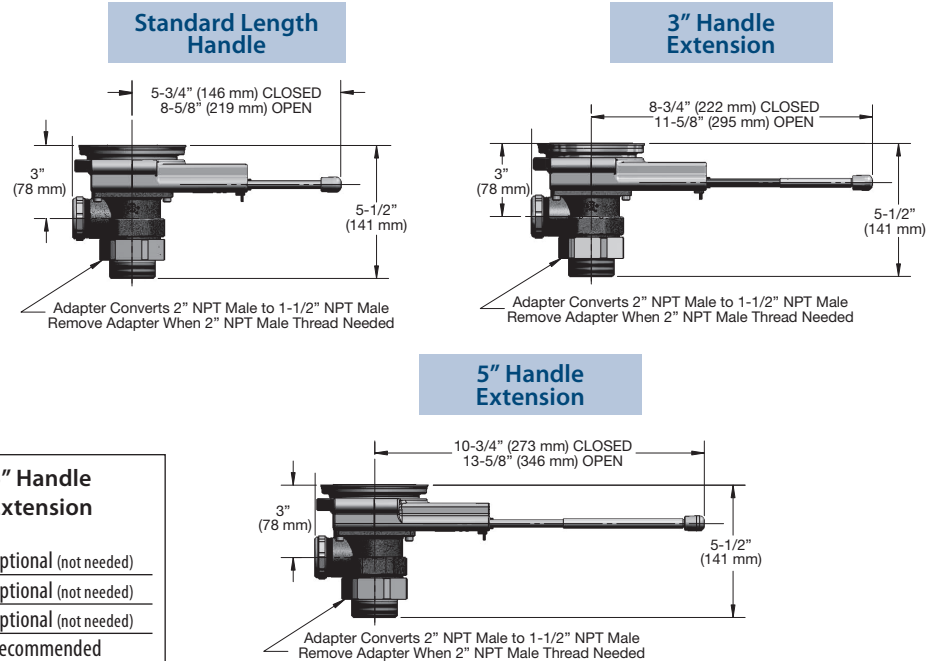

Sink Bowl Length (Front to back measurement of Sink Bottom)	3" Handle Extension	5" Handle Extension
18"	Optional (not needed)	Optional (not needed)
20"	Recommended	Optional (not needed)
24"	Recommended	Optional (not needed)
28"	Not recommended	Recommended

Recommended Extension Kits for the Modular Waste Valves Based On Popular Sink Bowl Length

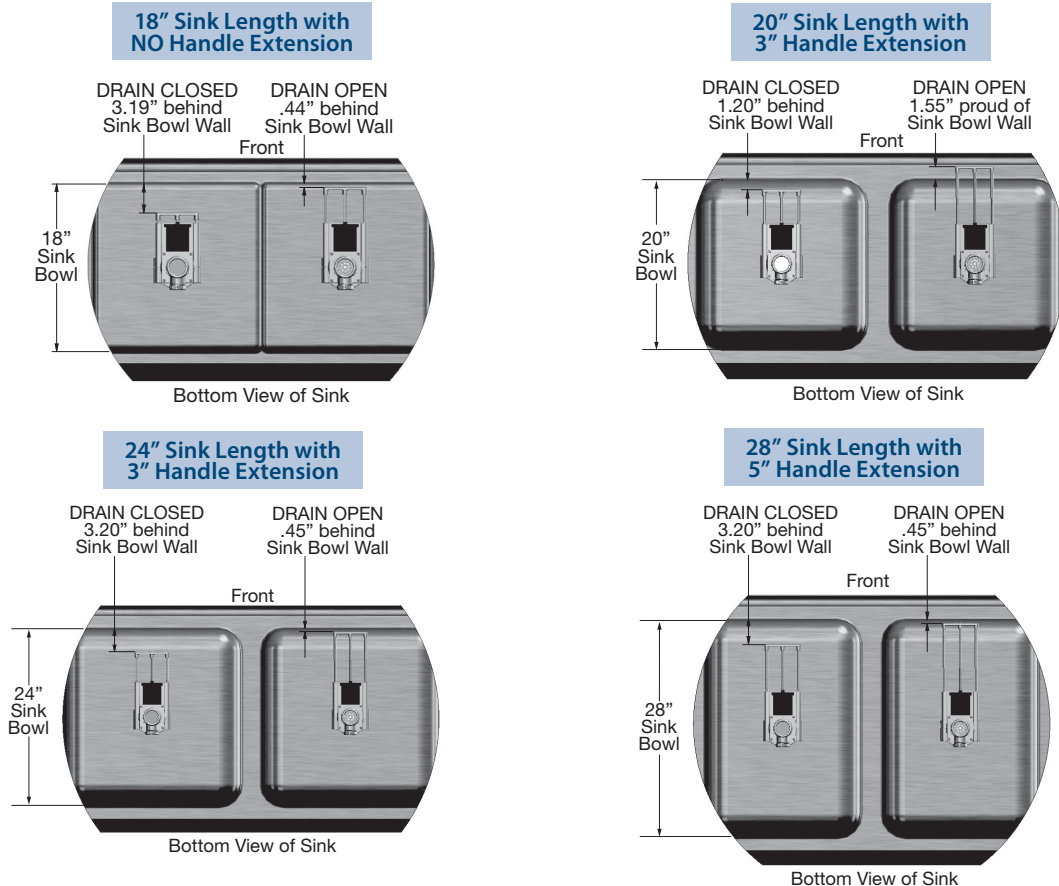

Modular Waste Valves

B-3990 Modular Waste Valve

- Modular design for easy installation and maintenance
- For 3-1/2" sink opening
- 2" NPT female x 1-1/2" NPT male adapter

B-3990-BSP Same as B-3990 except with 1-1/2" BSP male adapter
B-3990-3X Same as B-3990 except includes 3" handle extension kit
B-3990-5X Same as B-3990 except includes 5" handle extension kit
B-3990-BSP-3X Same as B-3990-BSP except includes 3" handle extension kit
B-3990-BSP-5X Same as B-3990-BSP except includes 5" handle extension kit



B-3992 shown closed (above) and open (below)

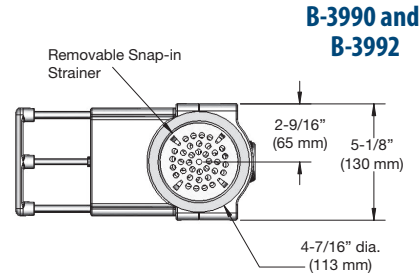
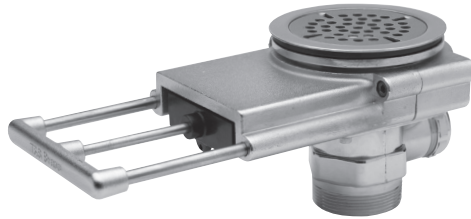

B-3990 and B-3992

B-3992 Modular Waste Valve

- Modular design for easy installation and maintenance
- For 3-1/2" sink opening
- 2" NPT male / 1-1/2" NPT female drain outlet

B-3992-3X Same as B-3992 except includes 3" handle extension kit
B-3992-5X Same as B-3992 except includes 5" handle extension kit

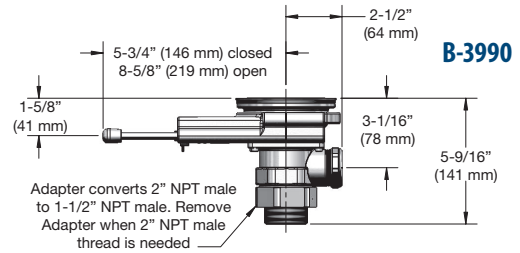

B-3990

B-3990-01 Modular Waste Valve with Overflow Tube with Head Assembly

- Modular design for easy installation and maintenance
- For 3-1/2" sink opening
- 2" NPT female x 1-1/2" NPT male adapter

B-3990-01-3X Same as B-3990-01 except includes 3" handle extension kit
B-3990-01-5X Same as B-3990-01 except includes 5" handle extension kit

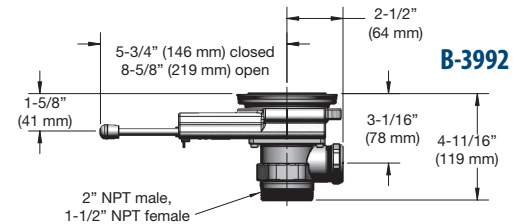
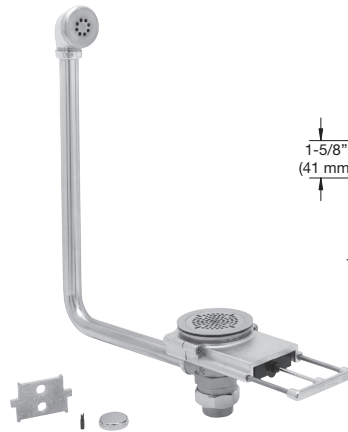

B-3992

B-3992-01 Modular Waste Valve with Overflow Tube with Head Assembly

- Modular design for easy installation and maintenance
- For 3-1/2" sink opening
- 2" NPT male / 1-1/2" NPT female drain outlet

B-3992-01-3X Same as B-3992-01 except includes 3" handle extension kit
B-3992-01-5X Same as B-3992-01 except includes 5" handle extension kit



NEW! Waste Valve Installation Tool:

Part # 017670-45

- Modular Waste Valve Installation Tool
- Included with all Modular Waste Valves
- Helps installation of both 3" and 3-1/2" drains
- Can order this part separately



RELIABILITY BUILT IN™



G-12
 *ChekPoint™ Electronic Faucets*





ChekPoint™ Electronic Faucets – CP

INTRODUCTORY PAGES

NEW FEATURED T&S PRODUCTS

- ChekPoint Faucets with Above Deck Electronics (ADE) CP3, 5
- NEW!** EC-3104, EC-3105, EC-3142 Electronic Faucets CP3-5

ChekPoint Above Deck Electronic (ADE) Sensor Faucets..... CP3, 5, 16-18

- ADE Models, Features and Options CP3, 5
- ADE Sensor Faucet Model Specs CP16-18
- Gooseneck Options (EC-3130 only) CP23

ChekPoint Standard Electronic Sensor Faucets CP4, 6, 10-15

- Models, Features and Options CP4, 6
- ChekPoint Below Deck Components CP8
- Below Deck Installation, Packaging CP9
- Standard Sensor Faucet Model Specs CP10-15
- Gooseneck Options (EC-3100, EC-3101 and EC-3105) CP8, 22

ChekPoint Electronic Sensor Faucet Options (all models) CP7-9,17, 21, 22

- Thermostatic Mixing Valves CP7
- Ganging Installation Options CP7
- Gooseneck Options CP8, 22, 23
- Deck Plate Options CP8, 21
- Other Data, Parts and Warranty CP9
- Side-Mount Thermostatic Mixing Valve (-SMT), and Thermostatic Mixing Valve (-TMV) CP8, 19
- EC-HYDROGEN – models, retrofit CP8, 19
- NEW!** EC-HYDROGEN-LF Low Flow Hydrogenerator – models, specs C8, 19, 20
- Ganging Installation Options – EASYWIRE, HARDWIRE and ADEWIRE C21
- Rigid Gooseneck Model Options C22
- Swivel Gooseneck Model Options C23

Other ChekPoint Electronic Faucets CP24

- ECR-D0810-107 Electronic Ware-Washing Rinse Faucet CP24

NOTE:
 A comprehensive Index By Model or Part Number and Page can be found in the G-12 General Product Catalog Master Index section (IN).



? Can't find the T&S product you're looking for?
 Please visit www.tsbrass.com for a complete product listing.

NEW MODELS in T&S's ChekPoint™ Above Deck Electronic Faucets

The EC-3130, EC-3132 and EC-3142 are the newest additions to the T&S ChekPoint Above Deck Electronic faucet line. Above Deck Electronics (ADE) allow for easy control, installation and maintenance.

Like all our ChekPoint faucets, these single hole above deck sensor faucets are designed to save water, money and energy with adjustable timed water flow and a choice of low flow vandal-resistant outlets.

T&S ADE sensor faucets are packed with features, including above deck temperature control with optional side control lever. All three base models are available with a factory installed hydrogenerator (-HG model) or retrofit (EC-HYDROGEN), and with 4" (-4DP) or 8" (-8DP) deck plates. Other options are available.



EC-3142



EC-3130-4DP



EC-3130



EC-3142



EC-3132



EC-3142-4DP



EC-3132-4DP



EC-3130-8DP

Now, you have many more options to choose from with our water-saving T&S ChekPoint™ Electronic Sensor Faucets! Along with ease of installation and convenient AC/DC power options, these other options are available to customize ChekPoint faucets:

Electronic Sensor Faucet OPTIONS		
Suffix/Option	Description	Applicable Models
-HG	Hydrogenerator	All models (1.0 GPM or greater)
-LF22	2.2 GPM Vandal-Resistant Laminar Flow	All models
-LN	Less nozzle; specify any T&S rigid gooseneck model	EC-3100, EC-3101
-SB	Surgical Bend Gooseneck	EC-3100, EC-3101
-SM	Side-Mount Mechanical Mixing Valve	EC-3100, EC-3102
-SMT	Side-Mount Thermostatic Mixing Valve	EC-3100, EC-3102
-TMV	Below Deck Thermostatic Mixing Valve	All models
-VF05	0.5 GPM Vandal-Resistant Non-Aerated Outlet	All models
EC-HARDWIRE	Gang up to 8 faucets/one power supply	All models
EC-EASYWIRE	Gang up to 8 faucets/one power supply	All models
EC-HYDROGEN	To retrofit a Hydrogenerator to an existing ChekPoint electronic faucet	All models; flow rate of 1.0 GPM or greater
EC-HYDROGEN-LF	Low Flow 1.0 GPM or less Hydrogenerator	All models; flow rate of 0.5 GPM - 1.0 GPM is required for use



EC-3100
Deck mount gooseneck

EC-3100-LF22-SB
Deck mount surgical bend gooseneck



EC-3101
Back splash-mount gooseneck



EC-3102
Deck mount cast spout



EC-3103
Deck mount cast spout



EC-3105
Wall mount gooseneck



EC-3104
Deck mount cast spout

T&S ChekPoint Electronic Faucet models listed in the two tables on pages CP5-6 offer options to customize each sensor faucet.

For any application you may have, T&S Electronic Faucets offer you an unparalleled ability to fulfill your specifications, and are backed by our solid reputation for both reliability and durability.



EC-3132-4DP

ABOVE DECK Electronic Faucets	EC-3130	EC-3132	EC-3142
Base Model FEATURES ✓			
Above Deck Electronics (ADE)	✓	✓	✓
AC/DC Power	✓	✓	✓
Adjustable Temperature Control Mixing Valve	✓	✓	✓
Check Valves	✓	✓	✓
Rigid/Swivel Gooseneck	✓		
Spout		✓	✓
Plug-In Transformer	✓	✓	✓
2.2 GPM Aerator, Vandal-Resistant	✓	✓	✓
Base Model OPTIONS ★			
Forged Brass Deckplate, 4"	EC-3130-4DP	EC-3132-4DP	EC-3142-4DP
Forged Brass Deckplate, 8"	EC-3130-8DP	EC-3132-8DP	EC-3142-8DP
2.2 GPM Laminar Flow Outlet, Vandal-Resistant (-LF22)	EC-3130-LF22	EC-3132-LF22	EC-3142-LF22
0.5 GPM Non-Aerated Outlet, Vandal-Resistant (-VF05)	EC-3130-VF05	EC-3132-VF05	EC-3142-VF05
1.0 GPM Non-Aerated Outlet, Vandal-Resistant	★	★	★
EC-EASYWIRE (3 options; p. CP7)	★	★	★
Hydrogenerator model	EC-3130-HG	EC-3132-HG	EC-3142-HG
Hydrogenerator as retrofit (EC-HYDROGEN); see p. CP19	★	★	★
Hydrogenerator, Low Flow 0.5 GPM – 1.0 GPM (EC-HYDROGEN-LF); see p. CP19	★	★	★
EC-ADEWIRE (33' cable for hardwire installation utilizing EC-HARDWIRE; see p. CP7)	★	★	★
EC-HARDWIRE (gang install up to eight ADE faucets; see p. CP7)	★	★	★
Optional side lever for adjustable temperature control	★	★	★



Electronic Sensor Faucets

- Hands-free washing greatly reduces risk of contamination
- Sensor-operated faucets conserve water and save energy
- Water-resistant circuit control module
- Each model comes with the convenience of electric plug-in (AC) and battery (DC) power options
- ADA-compliant
- Adjustable temperature control mixing valve
- Proven electronic technology
- Adjustable automatic time-out features (6)
- Adjustable water shut-off delays (4)
- Optional auto-flush feature flows water for 30 seconds after every 12 inactive hours
- Chrome plated brass
- Troubleshooting LED indicator lights
- Scratch-resistant sensor lens
- Filtered solenoid valve with serviceable strainer filter
- Modular quick-release sensor connections (below deck models only)
- Low battery indicator light
- Pre-assembled with appropriate mounting hardware included
- Vandal-resistant outlets
- Check valves for cross-flow prevention in all models
- Requires no sealants for easy installation



EC-FAUCETS	EC-3100	EC-3101	EC-3102	EC-3103	EC-3104	EC-3105
Base Model FEATURES ✓						
AC/DC Power	✓	✓	✓	✓	✓	✓
Adjustable Temperature Control Mixing Valve	✓	✓	✓	✓	✓	✓
Check Valves	✓	✓	✓	✓	✓	✓
Rigid Gooseneck	✓	✓				✓
Spout			✓	✓	✓	
2.2 GPM Aerator, Vandal-Resistant	✓	✓	✓	✓	✓	✓
Transformer Plug-In	✓	✓	✓	✓	✓	✓
Base Model OPTIONS ★						
Forged Brass Deckplate, 4"	★		EC-3102-4DP			
Forged Brass Deckplate, 8"	★		EC-3102-8DP			
2.2 GPM Laminar Flow Outlet, Vandal-Resistant (-LF22)	EC-3100-LF22	EC-3101-LF22	EC-3102-LF22	EC-3103-LF22	EC-3104-LF22	EC-3105-LF22
0.5 GPM Non-Aerated Outlet, Vandal-Resistant (-VF05)	EC-3100-VF05	EC-3101-VF05	EC-3102-VF05	EC-3103-VF05	EC-3104-VF05	EC-3105-VF05
1.0 GPM Non-Aerated Outlet, Vandal-Resistant	★	★	★	★	★	★
Rigid Gooseneck (up to 6")	★	★				★
Surgical Bend Gooseneck (-SB)	★	★				★
EC-HARDWIRE (see p. CP7)	★	★	★	★	★	★
EC-EASYWIRE (3 options; p. CP7)	★	★	★	★	★	★
Side-Mount Control Option (-SM)	★		EC-3102-SM			
Hydrogenerator (-HG); see p. CP19	EC-3100-HG	EC-3101-HG	EC-3102-HG	EC-3103-HG	EC-3104-HG	EC-3105-HG
Hydrogenerator for Retrofit, 1.0 GPM or greater (EC-HYDROGEN)	★	★	★	★	★	★
Hydrogenerator, Low Flow 0.5 GPM – 1.0 GPM (EC-HYDROGEN-LF); p. CP19	EC-3100-VF05-HG	★	EC-3102-VF05-HG	EC-3103-VF05-HG	EC-3104-VF05-HG	★
Side-Mount Above Deck Thermostatic Mixing Valve (-SMT; see p. CP7)	★		★			
Below Deck Thermostatic Mixing Valve (-TMV; see p. CP7)	EC-3100-TMV	EC-3101-TMV	EC-3102-TMV	EC-3103-TMV	EC-3104-TMV	EC-3105-TMV

ChekPoint Thermostatic Mixing Valves

The EC-SMT and EC-TMV thermostatic mixing valve options allow you to add a thermostatic mixing valve in either an above deck or below deck installation.

Features and benefits for both include:

- Solid low-lead brass construction
- Integral check valves built into hot and cold inlets to prevent backflow and water contamination
- ½" NPSM male fittings – easy to connect supply lines
- Filter screens included – prevent particles from damaging faucet or solenoid valves
- Tamper resistant temperature limit stop concealed under knob prevents water from exceeding desired maximum temperature
- Compatible with all ChekPoint faucets and accessories, including hydrogenerator
- Fully complies with the following:
 - ASME A112.18.1 / CSA B125.1 ANSI/NSF 61-Section 9
 - California Health and Safety Code 116875 (AB1953-2006)
 - NSF/ANSI 372 – Low Lead Content (0.25% Max)
 - ASSE 1070

EC-TMV

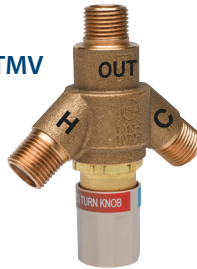

EC-SMT



EC-TMV:

- Designed for below deck or concealed installations
- Locking knob with color coded index – simple to adjust to the desired temperature
- Can be added to any ChekPoint faucet by specifying with a -TMV suffix (i.e. EC-3100-TMV)

EC-SMT:

- Designed for above deck installations – easy access for user to adjust temperature
- Accommodates sink or countertop up to 1 3/16" thickness with holes from 1" to 1 1/2" – universal design for virtually any application
- Polished chrome-plated handle – easy to clean, matches finish of all the ChekPoint faucets
- Lever style – simple to rotate and operate
- Vandal-resistant handle screw – prevents vandals from accessing the temperature limit stop
- Easy to identify temperature markings
- Fully complies with ADA (ICC/ANSI A117.1)

ChekPoint Faucets Ganging Option

Gang-install up to eight faucets with one power supply

The EC-HARDWIRE and EC-EASYWIRE installation options allow you to gang-install multiple ChekPoint models (up to eight) using only one power supply.

Options include:

- EC-HARDWIRE – 100-240 VAC Electronic AC transformer to hardwire up to eight (8) electronic ChekPoint faucets to a single power supply
- EC-EASYWIRE – 100-240 VAC Plug-in transformer allows up to eight (8) electronic ChekPoint faucets to be ganged to a single plug-in transformer (requires one EC-EASYWIRE4CC connector for each additional faucet in chain)
- EC-EASYWIRE4CC – 4' connector cables for EASYWIRE AC transformer connections in a daisy-chain circuit (one EC-EASYWIRE4CC needed for each additional faucet in chain)
- EC-EASYWIRE5EXT – 5' extension cables when additional cable length is needed for connections
- EC-ADEWIRE – 33' long cable used for EC-HARDWIRE for each Above Deck Electronic (ADE) faucet

EC-HARDWIRE

Electronic Transformer

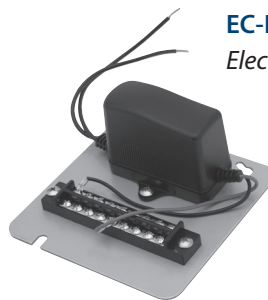

EC-EASYWIRE

100-240 VAC Plug-In Transformer



EC-EASYWIRE4CC

4' Connector Cables for EasyWire AC transformer connections



EC-ADEWIRE

33' Cable for EC-HARDWIRE for each ADE faucet

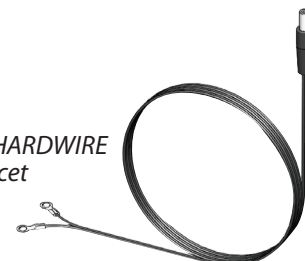

ChekPoint Faucet Gooseneck Options

For EC-3100 and EC-3101 models:

- Choice of any T&S Rigid Gooseneck on EC-3100 and EC-3101 faucet body models (up to 6" spread)

Ex: Specify an EC-3100-LN with a 122X rigid gooseneck

Note: In order to stay within the full range of the sensor, gooseneck spreads are limited to 6" max.

ChekPoint Faucet Components

Included with all Below Deck models:

- 1 Vandal-Resistant Outlet Key
- 2 Installation Tool – Tee Wrench (EC-3100, EC-3102 and EC-3103 models only)
- 3 Faucet Body with Sensor Connection (plugged into Control Module; EC-3100 faucet body shown)
- 4 Stainless Steel Braided Water Hose
- 5 Hot and Cold Stainless Steel Braided Water Hoses with Standard Adjustable Mixing Valve
- 6 Water Resistant Control Module (with door open to show four AA batteries)
- 7 Plug-in Wall Transformer (AC, standard)
- 8 Mechanical Mixing Valve (except for -SM, -SMT and -TMV models)

Options for all models:

- 9 EC-HYDROGEN 1.0 GPM or higher Hydrogenerator (-HG option, or retrofit to existing ChekPoint by ordering EC-HYDROGEN), OR
- 10 EC-HYDROGEN-LF Low Flow 0.5–1.0 GPM Hydrogenerator (Available for use on models with a flow rate between 0.5 GPM-1.0 GPM)
- 11 Side-Mount Above Deck Thermostatic Mixing Valve (-SMT option, or retrofit to existing ChekPoint by ordering EC-SMT)
- 12 Thermostatic Mixing Valve (-TMV option, or retrofit to existing ChekPoint by ordering EC-TMV)



ChekPoint Deck Plates

Deck Plate Features:

- Universal vandal-resistant deck plates
- 4" c/c and 8" c/c available
- Chrome plated brass
- Allow single-hole faucets to be installed in nearly any sink by covering and sealing unused holes
- Mounting hardware included; holds plates securely
- Gaskets provide a tight seal
- Vandal-resistant plates include threaded studs and flange nuts



013433-40 (4")



013434-40 (8")

To add a deck plate to an existing ChekPoint Electronic Faucet, order with these part numbers for each EC- faucet.

EC-model	4" Deck Plate	8" Deck Plate
EC-3100	013433-40	013434-40
EC-3101	n/a	n/a
EC-3102	013433-40	013434-40
EC-3103	n/a	n/a
EC-3130	013433-40	013434-40
EC-3132	013433-40	013434-40
EC-3142	013433-40	013434-40

ChekPoint Electronic Faucets Typical Below Deck Installation

Installation is simple with ChekPoint faucets:

- 1 Mount Faucet (Deck- or Wall-Mount)
- 2 Mount Control Module to Wall Below Sink
- 3 Connect Supply Lines
- 4 Connect Sensor Cable from Faucet to Control Module

Choose Your Power Options:

- 5 Mount and Attach EC-HYDROGEN 1.0 GPM or higher Hydrogenerator (-HG Models Only), OR
- 6 Mount and Attach EC-HYDROGEN-LF Low Flow 0.5–1.0 GPM Hydrogenerator (Available for use on models with a flow rate between 0.5 GPM-1.0 GPM)
- 7 Four 'AA' Batteries in Control Module (D/C, Included)
- 8 Electric Plug-In Wall Transformer (AC, Included)

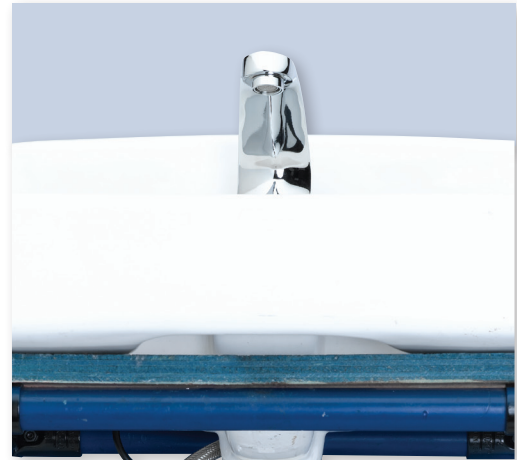

EC-HYDROGEN-LF

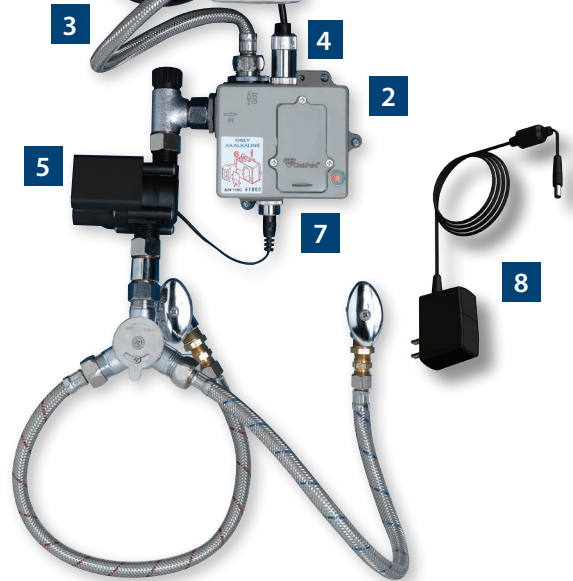

Packaging For the ChekPoint Electronic Faucet

All components are clearly packaged for ease of assembly.



Other Technical Data

Consult the applicable T&S Brass "Installation and Maintenance Instructions for ChekPoint Faucets" booklet for a complete guide to installing and maintaining your faucet.

Replacement Parts

A full range of replacement and repair parts are available for ChekPoint faucets with a list in the applicable ChekPoint "Installation and Maintenance Instructions" booklet.

Limited Three Year Warranty

T&S warrants ChekPoint faucets to be free from defects in material and workmanship for a period of three (3) years from the date of purchase.





Chekpoint™ Electronic Sensor Faucets

All models have: • Vandal-resistant aerator • AC/DC control module (electric plug-in and battery)

EC-3100 Electronic Faucet



- Adjustable automatic time-out features (6)
- Adjustable water shut-off delays (4)
- Optional auto-flush feature

- Chrome plated brass electronic faucet
- Deck mount rigid gooseneck
- B-0199-06 vandal-resistant aerator with key
- Height: 11" (279 mm)
- Spread: 4-1/8" (105 mm)
- Clearance: 7" (178 mm)
- (2) 18" (457 mm) long flexible supply hoses with 3/8" compression fittings
- Optional auto-flush feature flows water for 30 seconds after every 12 inactive hours
- Other rigid goosenecks can be specified (p. CP22)
- Includes 1/8" dia. anti-rotation pin
- Mechanical temperature mixing valve with integral check valves

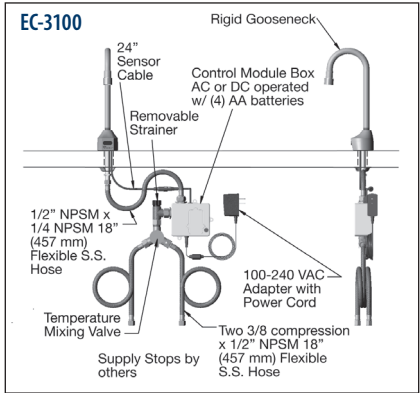

MODEL	GOOSENECK	HEIGHT	CLEARANCE	SPREAD	OUTLET	GPM	VR	NOTES
EC-3100	Rigid	11"	7"	4-1/8"	B-0199-06 VR aerator	2.2 GPM	Y	
EC-3100-120X	Rigid	12"	6-1/2"	5-1/2"	B-0199-06 VR aerator	2.2 GPM	Y	120X gooseneck
EC-3100-LF22	Rigid	11"	7"	4-1/8"	B-0199-21-VRF VR laminar flow device	2.2 GPM	Y	
EC-3100-HG	Rigid	11"	7"	4-1/8"	B-0199-06 VR aerator	2.2 GPM	Y	Includes EC-HYDROGEN hydrogenerator
EC-3100-LN	—	2-1/4"	—	—	—	—	Y	Less gooseneck/aerator
EC-3100-LF22-SB	Rigid	13"	7-5/8"	7-1/16"	B-0199-21-VRF VR laminar flow device	2.2 GPM	Y	Surgical bend gooseneck w/ VR laminar flow device; (see photo above)
EC-3100-SMT4	Rigid	11-5/16"	7-5/16"	4-1/8"	B-0199-06 VR aerator	2.2 GPM	Y	Includes EC-SMT above deck side mount adj. thermostatic mixing valve; 6-1/2" wide deck plate
EC-3100-SMT4V05	Rigid	11-5/16"	7-5/16"	4-1/8"	B-0199-06-N05 VR non-aerated spray device	0.5 GPM	Y	Includes EC-SMT above deck side mount adj. thermostatic mixing valve; 6-1/2" wide deck plate
EC-3100-SMT8	Rigid	11-5/16"	7-5/16"	4-1/8"	B-0199-06 VR aerator	2.2 GPM	Y	Includes EC-SMT above deck side mount adj. thermostatic mixing valve; 10" wide deck plate
EC-3100-SMT8V05	Rigid	11-5/16"	7-5/16"	4-1/8"	B-0199-06-N05 VR non-aerated spray device	0.5 GPM	Y	Includes EC-SMT above deck side mount adj. thermostatic mixing valve; 10" wide deck plate
EC-3100-TMV	Rigid	11"	7-5/16"	4-1/8"	B-0199-06 VR aerator	2.2 GPM	Y	Includes EC-TMV ASSE 1070 thermostatic temp. mixing valve with integral check valves
EC-3100-TMV4V05	Rigid	11-5/16"	7-5/16"	4-1/8"	B-0199-06-N05 VR non-aerated spray device	0.5 GPM	Y	Includes EC-TMV ASSE 1070 thermostatic temp. mixing valve with integral check valves; 6" wide deck plate
EC-3100-TMVHGF10	Rigid	11"	7"	4-1/8"	B-0199-06-F10 VR aerator	1.0 GPM	Y	Includes EC-HYDROGEN hydrogenerator power supply and EC-TMV ASSE 1070 thermostatic temp. mixing valve with integral check valves
EC-3100-VF05	Rigid	11"	7"	4-1/8"	B-0199-06-N05 VR non-aerated spray device	0.5 GPM	Y	
EC-3100-VF05-HG	Rigid	11"	7"	4-1/8"	B-0199-06-N05 VR non-aerated spray device	0.5 GPM	Y	EC-HYDROGEN-LF low flow hydrogenerator (see p. CP19-20)
EC-3100-VF05THG	Rigid	11"	7-5/16"	4-1/8"	B-0199-06-N05 VR non-aerated spray device	0.5 GPM	Y	Thermostatic mixing valve; EC-HYDROGEN-LF low flow hydrogenerator (see p. CP19-20)
EC-3100-VF5-TMV	Rigid	11"	7-5/16"	4-1/8"	B-0199-06-N05 VR non-aerated spray device	0.5 GPM	Y	Includes EC-TMV ASSE 1070 thermostatic temp. mixing valve with integral check valves
EC-3100-XP-LF10	Rigid (120XP)	11-1/4"	5-1/2"	5-1/2"	Plain end	1.0 GPM	N	Includes 1.0 GPM flow control check valve

VR Vandal-resistant

Chekpoint™ Electronic Sensor Faucets



All models have: • Vandal-resistant aerator • AC/DC control module (electric plug-in and battery)

EC-3101 Electronic Faucet



- Adjustable automatic time-out features (6)
- Adjustable water shut-off delays (4)
- Optional auto-flush feature

- Chrome plated brass electronic faucet
- Wall mount rigid gooseneck
- B-0199-06 vandal-resistant aerator with key
- Height: 11" (280 mm)
- Spread: 4-1/8" (104 mm)
- Clearance: 5-5/8" (143mm)
- (2) 18" (457 mm) long flexible supply hoses with 3/8" compression fittings
- Optional auto-flush feature flows water for 30 seconds after every 12 inactive hours
- Other rigid goosenecks can be specified (p. CP22)
- Includes anti-rotation screw
- Mechanical temperature mixing valve with integral check valves

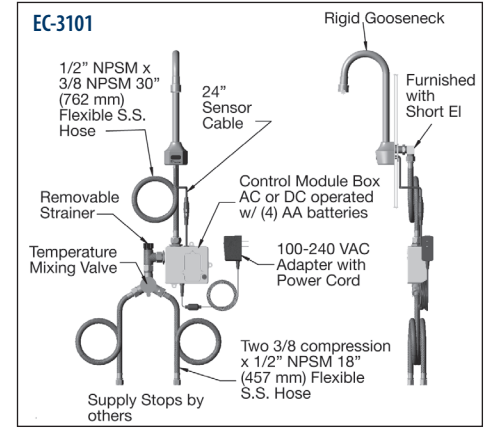

MODEL	GOOSENECK	HEIGHT	CLEARANCE	SPREAD	OUTLET	GPM	VR	NOTES
EC-3101	Rigid	11"	5-5/8"	4-1/8"	B-0199-06 VR aerator	2.2 GPM	Y	
EC-3101-HG	Rigid	11"	5-5/8"	4-1/8"	B-0199-06 VR aerator	2.2 GPM	Y	Includes EC-HYDROGEN hydrogenerator power supply
EC-3101-LF22	Rigid	11"	5-5/8"	4-1/8"	B-0199-21-VRF VR laminar flow device	2.2 GPM	Y	
EC-3101-LN	—	2-3/16"	—	—	—	—	—	Less nozzle/aerator
EC-3101-LF22-SB	Rigid	11-5/8"	6-3/16"	7-1/16"	B-0199-21-VRF VR laminar flow device	2.2 GPM	Y	Surgical bend gooseneck
EC-3101-TMV	Rigid	11"	5-5/8"	4-1/8"	B-0199-06 VR aerator	2.2 GPM	Y	Includes EC-TMV ASSE 1070 thermostatic temp. mixing valve with integral check valves
EC-3101-TMVHGF10	Rigid	11"	5-5/8"	4-1/8"	B-0199-06-F10 VR aerator	1.0 GPM	Y	Includes EC-HYDROGEN hydrogenerator power supply and EC-TMV ASSE 1070 thermostatic temp. mixing valve with integral check valves
EC-3101-VF05	Rigid	11"	5-5/8"	4-1/8"	B-0199-06-N05 VR non-aerated spray device	0.5 GPM	Y	
EC-3101-VF5-TMV	Rigid	11"	5-5/8"	4-1/8"	B-0199-06-N05 VR non-aerated spray device	0.5 GPM	Y	Includes EC-TMV ASSE 1070 thermostatic temp. mixing valve with integral check valves
EC-3101-XP-LF10	Rigid (120XP)	11-5/32"	4-15/16"	5-1/2"	Plain end	1.0 GPM	Y	Includes 1.0 GPM flow control check valve

VR Vandal-resistant



Chekpoint™ Electronic Sensor Faucets



All models have: • Vandal-resistant aerator • AC/DC control module (electric plug-in and battery)

EC-3102
Electronic Faucet



- Adjustable automatic time-out features (6)
- Adjustable water shut-off delays (4)
- Optional auto-flush feature

- Chrome plated brass electronic faucet
- Single hole deck mount cast spout
- B-0199-08 vandal-resistant aerator with key
- Height: 5-1/16" (129 mm)
- Spout length: 4-7/8" (124 mm)
- Clearance: 4-1/16" (103 mm)
- (2) 18" (457 mm) long flexible supply hoses with 3/8" compression fittings
- Optional auto-flush feature flows water for 30 seconds after every 12 inactive hours
- Includes 1/8" dia. anti-rotation pin
- Mechanical temperature mixing valve with integral check valves

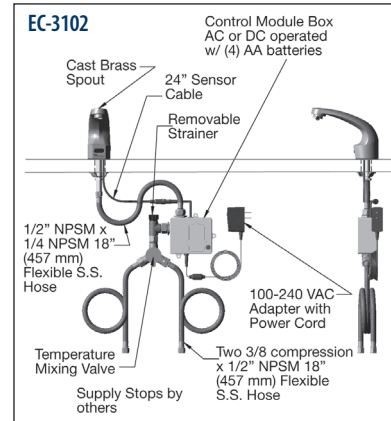

MODEL	NOZZLE	HEIGHT	CLEARANCE	SPREAD	OUTLET	GPM	VR	NOTES
EC-3102	Cast Spout	5-1/16"	4-1/16"	4-7/8"	B-0199-08 VR aerator	2.2 GPM	Y	
EC-3102-HG	Cast Spout	5-1/16"	4-1/16"	4-7/8"	B-0199-08 VR aerator	2.2 GPM	Y	Includes EC-HYDROGEN hydrogenator power supply
EC-3102-LF22	Cast Spout	5-1/16"	4-1/16"	4-7/8"	B-0199-28-VRF VR laminar flow device	2.2 GPM	Y	
EC-3102-SM	Cast Spout	5-3/8"	4-3/8"	4-7/8"	B-0199-08 VR aerator	2.2 GPM	Y	Side-mount mechanical mixer (B-2740); includes 10" wide deck plate
EC-3102-SMT4	Cast Spout	5-3/8"	4-3/8"	4-7/8"	B-0199-08 VR aerator	2.2 GPM	Y	Includes EC-SMT above deck side mount adj. thermostatic mixing valve; 6-1/2" wide deck plate
EC-3102-SMT4V05	Cast Spout	5-3/8"	4-3/8"	4-7/8"	B-0199-08-N05 VR non-aerated spray device	0.5 GPM	Y	Includes EC-SMT above deck side mount adj. thermostatic mixing valve; 6-1/2" wide deck plate
EC-3102-SMT8	Cast Spout	5-3/8"	4-3/8"	4-7/8"	B-0199-08 VR aerator	2.2 GPM	Y	Includes EC-SMT above deck side mount adj. thermostatic mixing valve; 10" wide deck plate
EC-3102-SMT8V05	Cast Spout	5-3/8"	4-3/8"	4-7/8"	B-0199-08-N05 VR non-aerated spray device	0.5 GPM	Y	Includes EC-SMT above deck side mount adj. thermostatic mixing valve; 10" wide deck plate
EC-3102-TMV	Cast Spout	5-1/16"	4-1/16"	4-7/8"	B-0199-08 VR aerator	2.2 GPM	Y	Includes EC-TMV ASSE 1070 thermostatic temp. mixing valve with integral check valves
EC-3102-TMV4V05	Cast Spout	5-3/8"	4-3/8"	4-7/8"	B-0199-08-N05 VR non-aerated spray device	0.5 GPM	Y	Includes EC-TMV ASSE 1070 thermostatic temp. mixing valve with integral check valves; 6" wide deck plate
EC-3102-VF05	Cast Spout	5-1/16"	4-1/16"	4-7/8"	B-0199-08-N05 VR non-aerated spray device	0.5 GPM	Y	
EC-3102-VF05-HG	Cast Spout	5-1/16"	4-1/16"	4-7/8"	B-0199-08-N05 VR non-aerated spray device	0.5 GPM	Y	EC-HYDROGEN-LF low flow hydrogenator (see p. CP19-20)
EC-3102-VF05THG	Cast Spout	5-1/16"	4-1/16"	4-7/8"	B-0199-08-N05 VR non-aerated spray device	0.5 GPM	Y	Thermostatic mixing valve; EC-HYDROGEN-LF low flow hydrogenator (see p. CP19-20)
EC-3102-VF5-TMV	Cast Spout	5-1/16"	4-1/16"	4-7/8"	B-0199-08-N05 VR non-aerated spray device	0.5 GPM	Y	Includes EC-TMV ASSE 1070 thermostatic temp. mixing valve with integral check valves

VR Vandal-resistant

Chekpoint™ Electronic Sensor Faucets



All models have: • Vandal-resistant aerator • AC/DC control module (electric plug-in and battery)

EC-3103 Electronic Faucet



- Adjustable automatic time-out features (6)
- Adjustable water shut-off delays (4)
- Optional auto-flush feature

- Chrome plated brass electronic faucet
- Deck mount cast spout
- 4" centerset
- B-0199-08 vandal-resistant aerator with key
- Height: 5-1/16" (129 mm)
- Spout length: 4-7/8" (124 mm)
- Clearance: 4-1/16" (103 mm)
- Optional auto-flush feature flows water for 30 seconds after every 12 inactive hours
- Mechanical temperature mixing valve with integral check valves

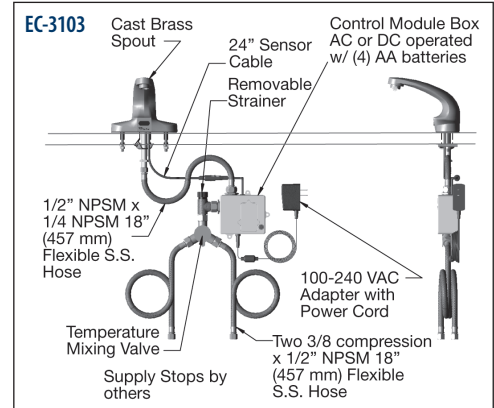

MODEL	NOZZLE	HEIGHT	CLEARANCE	SPREAD	OUTLET	GPM	VR	NOTES
EC-3103	Cast Spout	5-1/16"	4-1/16"	4-7/8"	B-0199-08 VR aerator	2.2 GPM	Y	
EC-3103-HG	Cast Spout	5-1/16"	4-1/16"	4-7/8"	B-0199-08 VR aerator	2.2 GPM	Y	Includes EC-HYDROGEN hydrogenerator power supply
EC-3103-LF22	Cast Spout	5-1/16"	4-1/16"	4-7/8"	B-0199-28 VR laminar flow device	2.2 GPM	Y	
EC-3103-TMV	Cast Spout	5-1/16"	4-1/16"	4-7/8"	B-0199-08 VR aerator	2.2 GPM	Y	Includes EC-TMV ASSE 1070 thermostatic temp. mixing valve with integral check valves
EC-3103-VF05	Cast Spout	5-1/16"	4-1/16"	4-7/8"	B-0199-08-N05 VR non-aerated spray device	0.5 GPM	Y	
EC-3103-VF05-HG	Cast Spout	5-1/16"	4-1/16"	4-7/8"	B-0199-08-N05 VR non-aerated spray device	0.5 GPM	Y	EC-HYDROGEN-LF low flow hydrogenerator (see p. CP19-20)
EC-3103-VF05THG	Cast Spout	5-1/16"	4-1/16"	4-7/8"	B-0199-08-N05 VR non-aerated spray device	0.5 GPM	Y	Thermostatic mixing valve; EC-HYDROGEN-LF low flow hydrogenerator (see p. CP19-20)
EC-3103-VF5-TMV	Cast Spout	5-1/16"	4-1/16"	4-7/8"	B-0199-08-N05 VR non-aerated spray device	0.5 GPM	Y	Includes EC-TMV ASSE 1070 thermostatic temp. mixing valve with integral check valves

VR Vandal-resistant

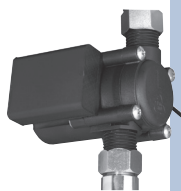

To order the standard CheckPoint™ Sensor Faucet models to include the Hydrogenerator (add -HG) to:

- EC-3100-HG
- EC-3101-HG
- EC-3102-HG
- EC-3103-HG



To order the standard CheckPoint™ Sensor Faucet models to include the Side-mount Above Deck Thermostatic mixing valve (add -SMT) to:

- EC-3100-SMT
- EC-3102-SMT



To order the standard CheckPoint™ Sensor Faucet models to include the below deck Thermostatic mixing valve (add -TMV) to:

- EC-3100-TMV
- EC-3101-TMV
- EC-3102-TMV
- EC-3103-TMV



Chekpoint™ Electronic Sensor Faucets



All models have: • Vandal-resistant aerator • AC/DC control module (electric plug-in and battery)

EC-3105 Electronic Faucet



- Adjustable automatic time-out feaures (6)
- Adjustable water shut-off delays (4)
- Optional auto-flush feature

- Chrome plated brass electronic faucet
- 4" C/C (2-hole) wall mount rigid gooseneck
- B-0199-06 vandal-resistant aerator with key
- Height: 11" (280 mm)
- Spread: 4-1/8" (105 mm)
- Clearance: 5-15/16" (151 mm)
- (2) 18" (457 mm) long flexible supply hoses with 3/8" compression fittings
- Optional auto-flush feature flows water for 30 seconds after every 12 inactive hours
- Includes 1/8" dia. anti-rotation pin
- Mechanical temperature mixing valve with integral check valves

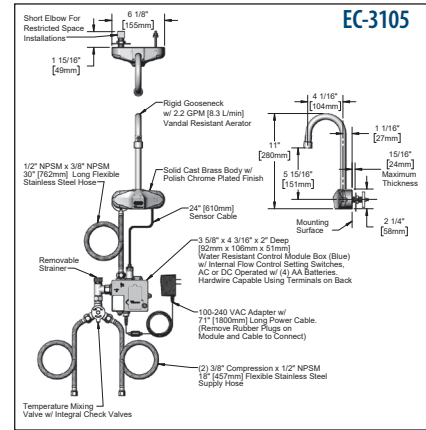

MODEL	GOOSENECK	HEIGHT	CLEARANCE	SPREAD	OUTLET	GPM	VR	NOTES
EC-3105	Rigid	11"	5-15/16"	4-1/8"	B-0199-06 VR aerator	2.2 GPM	Y	
EC-3105-HG	Rigid	11"	5-15/16"	4-1/8"	B-0199-06 VR aerator	2.2 GPM	Y	Includes EC-HYDROGEN hydrogenerator power supply
EC-3105-LF22	Rigid	11"	5-15/16"	4-1/8"	B-0199-21-VRF VR laminar flow outlet	2.2 GPM	Y	
EC-3105-LMV	Rigid	11"	5-15/16"	4-1/8"	B-0199-06 VR aerator	2.2 GPM	Y	Less mixing valve
EC-3105-LN	—	—	—	—	—	—	—	Less gooseneck; see p. CP22 for available gooseneck options
EC-3105-TMV	Rigid	11"	5-15/16"	4-1/16"	B-0199-06 VR aerator	2.2 GPM		Includes EC-TMV ASSE 1070 thermostatic temp. mixing valve with integral check valves
EC-3105-VF05	Rigid	11"	5-15/16"	4-1/16"	B-0199-06-N05 VR non-aerated spray device	0.5 GPM	Y	
EC-3105-VF12	Rigid	11"	5-15/16"	4-1/16"	B-0199-06-F12 VR aerator	1.2 GPM	Y	
EC-3105-VF5-TMV	Rigid	11"	5-15/16"	4-1/16"	B-0199-06-N05 VR non-aerated spray device	0.5 GPM	Y	Includes EC-TMV ASSE 1070 thermostatic temp. mixing valve with integral check valves

VR Vandal-resistant

ChekPoint™ Faucets with Above Deck Electronics and Temperature Control



- All EC-3130 series models have:
- Check valve adapters for crossflow protection
 - AC/DC power option
 - Hands-free washing reduces risk of contamination and saves water
 - Up to 8 models can be ganged together (EC-HARDWIRE)

EC-3130 Electronic Faucet



- Adjustable automatic time-out features (6)
- Adjustable water shut-off delays (4)
- Optional auto-flush feature

- Chrome plated brass single hole deck mount electronic sensor faucet
- Above deck electronics for easy installation and maintenance
- Chrome plated brass body
- Swivel/rigid gooseneck (includes lock washer for rigid conversion)
- 2.2 GPM vandal-resistant aerator with key (B-0199-06)
- Temperature mixing handle with color coded index
- Optional plug replaces lever handle when pre-setting temperature
- (2) 3/8" compression, 19" (483 mm) long flexible stainless steel hot and cold water supply hoses
- Optional auto-flush feature flows water for 30 seconds after every 12 inactive hours
- Check valve adapters for crossflow prevention
- Other swivel goosenecks can be specified (p. CP23)
- AC/DC power option
- Hands-free washing reduces risk of contamination and saves water
- Up to (8) eight models can be ganged together using EC-HARDWIRE

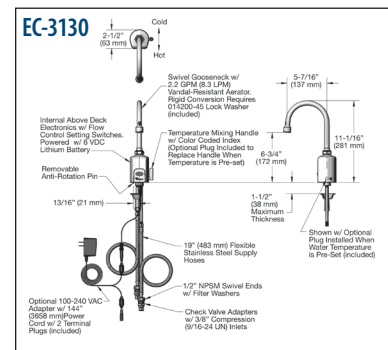
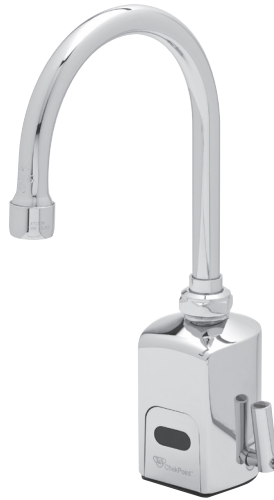

MODEL	GOOSENECK	HEIGHT	CLEARANCE	SPREAD	OUTLET	GPM	VR	NOTES
EC-3130	Swivel/Rigid Gooseneck	11-1/16"	6-3/4"	5-7/16"	B-0199-06 VR aerator	2.2 GPM	Y	Optional conversion to rigid requires lock washer (included)
EC-3130-4DP	Swivel/Rigid Gooseneck	11-7/16"	7-1/16"	5-7/8"	B-0199-06 VR aerator	2.2 GPM	Y	4" centers forged brass chrome plated deck plate
EC-3130-8DP	Swivel/Rigid Gooseneck	11-7/16"	7-1/16"	5-7/8"	B-0199-06 VR aerator	2.2 GPM	Y	8" centers forged brass chrome plated deck plate
EC-3130-HG	Swivel/Rigid Gooseneck	11-1/16"	6-3/4"	5-7/16"	B-0199-06 VR aerator	2.2 GPM	Y	Includes EC-HYDROGEN hydrogenerator power supply; optional AC/DC power
EC-3130-LF22	Swivel/Rigid Gooseneck	11-1/16"	6-3/4"	5-7/16"	B-0199-21-VRF VR laminar flow device	2.2 GPM	Y	
EC-3130-LN	—	—	—	—	—	—	—	Less gooseneck/aerator
EC-3130-ST-VF05	Swivel/Rigid Gooseneck	11-1/16"	6-3/4"	5-7/16"	B-0199-06-N05 VR non-aerated spray device	0.5 GPM	Y	Single temperature; lever handle replaced with plug
EC-3130-STV5THG	Swivel/Rigid Gooseneck	11-1/16"	6-3/4"	5-7/16"	B-0199-06-N05 VR non-aerated spray device	0.5 GPM	Y	Single temperature; Thermostatic mixing valve; EC-HYDROGEN-LF low flow hydrogenerator (see p. CP19-20)
EC-3130-VF05	Swivel/Rigid Gooseneck	11-1/16"	6-3/4"	5-7/16"	B-0199-06-N05 VR non-aerated spray device	0.5 GPM	Y	
EC-3130-XP-F10	Swivel/Rigid Gooseneck	10-11/16"	6-3/4"	5-11/16"	Plain end	1.0 GPM	Y	1.0 GPM Flow regulator swivel piece
EC-3130-XP-F15	Swivel/Rigid Gooseneck	10-11/16"	6-3/4"	5-11/16"	Plain end	1.5 GPM	Y	1.5 GPM Flow regulator swivel piece

VR Vandal-resistant

ChekPoint™ Faucets with Above Deck Electronics and Temperature Control



- All EC-3132 series models have:
- Check valve adapters for crossflow protection
 - AC/DC power option
 - Hands-free washing reduces risk of contamination and saves water
 - Up to 8 models can be ganged together (EC-HARDWIRE)

EC-3132 Electronic Faucet



- Adjustable automatic time-out features (6)
- Adjustable water shut-off delays (4)
- Optional auto-flush feature

- Chrome plated brass single hole deck mount electronic sensor faucet
- Above deck electronics for easy installation and maintenance
- Chrome plated brass body
- Temperature mixing handle with color coded index
- Cast spout
- 2.2 GPM vandal-resistant aerator with key (B-0199-08)
- Optional plug replaces lever handle when pre-setting temperature
- (2) 3/8" compression, 19" (483 mm) long flexible stainless steel hot and cold water supply hoses
- Optional auto-flush feature flows water for 30 seconds after every 12 inactive hours
- Check valve adapters for crossflow prevention
- AC/DC power option
- Hands-free washing reduces risk of contamination and saves water
- Up to (8) eight models can be ganged together using EC-HARDWIRE

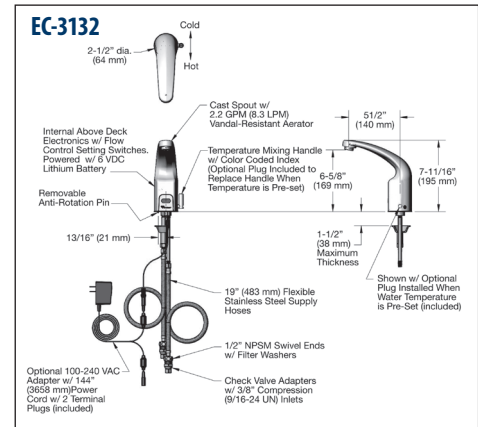

MODEL	NOZZLE	HEIGHT	CLEARANCE	SPREAD	OUTLET	GPM	VR	NOTES
EC-3132	Cast Spout	7-11/16"	6-5/8"	5-1/2"	B-0199-08 VR aerator	2.2 GPM	Y	
EC-3132-4DP	Cast Spout	8-1/16"	7"	5-1/2"	B-0199-08 VR aerator	2.2 GPM	Y	4" centers forged brass chrome plated deck plate
EC-3132-8DP	Cast Spout	8-1/16"	7"	5-1/2"	B-0199-08 VR aerator	2.2 GPM	Y	8" centers forged brass chrome plated deck plate
EC-3132-HG	Cast Spout	7-11/16"	6-5/8"	5-1/2"	B-0199-08 VR aerator	2.2 GPM	Y	Includes EC-HYDROGEN hydrogenerator power supply; optional AC/DC power
EC-3132-LF22	Cast Spout	7-11/16"	6-5/8"	5-1/2"	B-0199-28 VR laminar flow device	2.2 GPM	Y	
EC-3132-ST-VF05	Cast Spout	7-11/16"	6-3/4"	5-1/2"	B-0199-06-N05 VR non-aerated spray device	0.5 GPM	Y	Single temperature; lever handle replaced with plug
EC-3132-STV5THG	Cast Spout	7-11/16"	6-5/8"	5-1/2"	B-0199-06-N05 VR non-aerated spray device	0.5 GPM	Y	Single temperature; Thermostatic mixing valve; EC-HYDROGEN-LF low flow hydrogenerator (see p. CP19-20)
EC-3132-VF05	Cast Spout	7-11/16"	6-5/8"	5-1/2"	B-0199-08-N05 VR non-aerated spray device	0.5 GPM	Y	

VR Vandal-resistant



ChekPoint™ Faucets with Above Deck Electronics and Temperature Control



- All EC-3142 series models have:
- Check valve adapters for crossflow protection
 - AC/DC power option
 - Hands-free washing reduces risk of contamination and saves water
 - Up to 8 models can be ganged together (EC-HARDWIRE)

EC-3142 Electronic Faucet



- Adjustable automatic time-out features (6)
- Adjustable water shut-off delays (4)
- Optional auto-flush feature

- Chrome plated brass single hole deck mount electronic sensor faucet
- Above deck electronics for easy installation and maintenance
- Chrome plated brass body
- Temperature mixing handle with color coded index
- Cast spout
- 2.2 GPM vandal-resistant aerator with key (B-0199-08)
- Optional plug replaces lever handle when pre-setting temperature
- (2) 3/8" compression, 19" (483 mm) long flexible stainless steel hot and cold water supply hoses
- Optional auto-flush feature flows water for 30 seconds after every 12 inactive hours
- Check valve adapters for crossflow prevention
- AC/DC power option
- Hands-free washing reduces risk of contamination and saves water
- Up to (8) eight models can be ganged together using EC-HARDWIRE

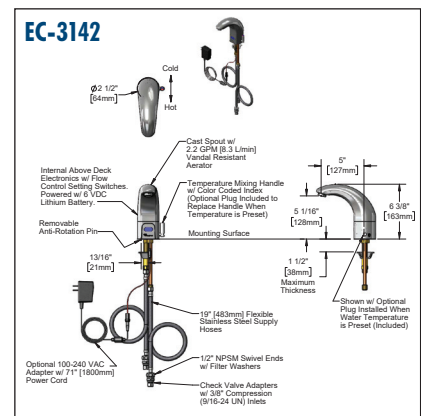

MODEL	NOZZLE	HEIGHT	CLEARANCE	SPREAD	OUTLET	GPM	VR	NOTES
EC-3142	Cast Spout	6-3/8"	5-1/16"	5"	B-0199-08 VR Aerator	2.2 GPM	Y	
EC-3142-4DP	Cast Spout	6-3/4"	5-3/8"	5"	B-0199-08 VR Aerator	2.2 GPM	Y	4" centers forged brass chrome plated deck plate
EC-3142-8DP	Cast Spout	6-3/4"	5-3/8"	5"	B-0199-08 VR Aerator	2.2 GPM	Y	8" centers forged brass chrome plated deck plate
EC-3142-HG	Cast Spout	6-3/8"	5-1/16"	5"	B-0199-08 VR Aerator	2.2 GPM	Y	Includes EC-HYDROGEN hydrogenerator power supply; optional AC/DC power
EC-3142-LF22	Cast Spout	6-3/8"	5-1/16"	5"	B-0199-28 VR Laminar Flow Device	2.2 GPM	Y	
EC-3142-ST-VF05	Cast Spout	6-3/8"	5-1/16"	5-1/16"	B-0199-08-N05 VR non-aerated spray device	0.5 GPM	Y	-ST Single temperature faucet
EC-3142-STV5THG	Cast Spout	6-3/8"	5-1/16"	5-1/16"	B-0199-08-N05 VR non-aerated spray device	0.5 GPM	Y	Single temperature faucet; Thermostatic mixing valve; EC-HYDROGEN-LF low flow hydrogenerator (p. CP19-20)
EC-3142-VF05	Cast Spout	6-3/8"	5-1/16"	5"	B-0199-08-N05 VR non-aerated spray device	0.5 GPM	Y	

VR Vandal-resistant

T&S EC-3132 and EC-3142 Faucet Options: DECK PLATES

- Forged brass chrome plated deck plates
- Available for use with single hole faucets
- To add a deck plate to an existing faucet, order:
 - 4" Centers (013433-40)
 - 8" Centers (013434-40)



See p. CP8 and CP21 for more information about deck plates

ChekPoint™ Electronic Faucets / Model Options



EC-HYDROGEN
Hydrogenerator Accessory
For ChekPoint™ Faucets

- Hydrogenerator with 1/2 NPSM male inlet and outlet threads
- Accessory for all ChekPoint™ Electronic Sensor Faucets
- Includes generator, (1) 1/2 NPSM swivel coupling
- 71" (1800 mm) power cord with male plug to connect to control module
- Average estimated lifespan for EC-HYDROGEN is ten years (estimate based on 1 million cycles in lab testing; individual results may differ)
- To order the standard CheckPoint™ Sensor Faucet models to include the hydrogenerator, add -HG, ie.: EC-3100-HG
- Order EC-HYDROGEN to retrofit hydrogenerator to any EC-model



EC-HYDROGEN

Note: Minimum flow rate of 1.0 GPM is required for applications using EC-HYDROGEN.

EC-HYDROGEN-LF
Low Flow Hydrogenerator
For Select ChekPoint™ Faucets

- **NEW Low Flow Hydrogenerator** with 1/2 NPSM male inlet and outlet threads
- Accessory for select ChekPoint™ Electronic Sensor Faucets with a flow rate of 0.5 to 1.0 GPM (see p. CP20 for model list)
- Includes generator, (1) 1/2 NPSM swivel coupling
- 71" (1800 mm) power cord with male plug to connect to control module
- EC-HYDROGEN-LF provides up to ten years of battery life
- Requires a minimum of ten activations a day at a minimum of both 0.5 GPM and 20 PSI to maintain charge



EC-HYDROGEN-LF

Note: Flow rate of 0.5 to 1.0 GPM is required for applications using EC-HYDROGEN-LF.

See page CP20 for more information and models available

EC-SMT
Side-Mount Thermostatic Mixing Valve

- Side-mount above deck thermostatic mixing valve
- Polished chrome-plated handle with vandal-resistant screw
- Designed for point-of-use temperature adjustment
- Universal design accommodates virtually any application; countertops up to 1-3/16" thick, holes from 1" to 1-1/2" diameter
- Available for EC-3100 and EC-3102 models



To order the standard CheckPoint™ Sensor Faucet models to include the **side-mount thermostatic mixing valve** (add -SMT):

EC-3100-SMT
EC-3102-SMT

Note: these are the only two EC-models available with -SMT

EC-TMV
Thermostatic Mixing Valve

- Thermostatic mixing valve with 1/2" NPSM male fittings
- Tested and certified to ASSE 1070
- Integral check valves with filter washers in hot and cold inlets
- Tamper resistant locking adjustment knob prevents water from exceeding pre-set maximum temperature
- Can be added to any ChekPoint™ faucet; specify with -TMV suffix



To order the standard CheckPoint™ Sensor Faucet models to include the **thermostatic mixing valve** (add -TMV):

EC-3100-TMV EC-3122-TMV
EC-3101-TMV EC-3130-TMV
EC-3106-TMV EC-3132-TMV

EC-FILTER
Electronic Faucet

- Replacement filter for ChekPoint™ control module

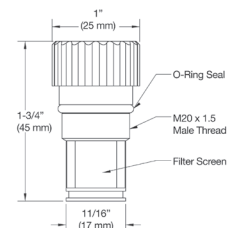

Introducing the T&S Brass

EC-HYDROGEN-LF Series

ChekPoint Electronic Sensor Faucets with Low Flow Hydrogenerator

Imagine a low flow faucet that generates and stores its own power through the flow of water without the need for hardwire or battery back-up.

T&S is pleased to announce our newest sensor faucet innovation: The T&S ChekPoint™ EC-HYDROGEN-LF Low Flow Hydrogenerator.

Hydroelectric Power Supply with a 0.5 to 1.0 GPM flow rate.

Finally, a self-sustaining power solution to meet low flow LEED requirements. Our new low flow hydrogenerator is available for use on sensor faucets requiring a flow rate of less than 1.0 GPM.

- Flow rate of 0.5 GPM – 1.0 GPM is required for use with low flow hydrogen (See below for available faucet models)
- Utilizes hydroelectric power, eliminating the need for batteries or hardwire transformers
- Generates and stores its own power, saving energy and money
- Requires a minimum of ten activations a day at a minimum of both 0.5 GPM and 20 PSI to maintain charge
- Provides up to 10 years of battery life



NEW ChekPoint Sensor Faucet Models with Low Flow Hydrogenerator

EC- Faucet Models without Thermostatic Mixing Valve						
	Below Deck Electronics	Above Deck Electronics	Faucet Description	Spout	Outlet/Flow Rate	Thermostatic Mixing Valve
EC-HYDROGEN-LF	ChekPoint Low Flow Generator, 1.0 GPM max.					
EC-3100-VF05-HG	✓		Single hole deck mount	Gooseneck	VR 0.5 GPM Non-aerated spray device	–
EC-3102-VF05-HG	✓		Single hole deck mount	Cast spout	VR 0.5 GPM Non-aerated spray device	–
EC-3103-VF05-HG	✓		4" centerset (3 hole) deck mount	Cast spout	VR 0.5 GPM Non-aerated spray device	–
EC-3104-VF05-HG	✓		4" centers (2 hole) deck mount	Cast spout	VR 0.5 GPM Non-aerated spray device	–
EC- Faucet Models with Thermostatic Mixing Valve						
EC-3100-VF05THG	✓		Single hole deck mount	Gooseneck	VR 0.5 GPM Non-aerated spray device	✓
EC-3102-VF05THG	✓		Single hole deck mount	Cast spout	VR 0.5 GPM Non-aerated spray device	✓
EC-3103-VF05THG	✓		4" centerset (3 hole) deck mount	Cast spout	VR 0.5 GPM Non-aerated spray device	✓
EC-3104-VF05THG	✓		4" centers (2 hole) deck mount	Cast spout	VR 0.5 GPM Non-aerated spray device	✓
EC-3130-STV5THG		✓	Single hole single temperature deck mount	Gooseneck	VR 0.5 GPM Non-aerated spray device	✓
EC-3132-STV5THG		✓	Single hole single temperature deck mount	Cast spout	VR 0.5 GPM Non-aerated spray device	✓
EC-3142-STV5THG		✓	Single hole single temperature deck mount	Cast spout	VR 0.5 GPM Non-aerated spray device	✓

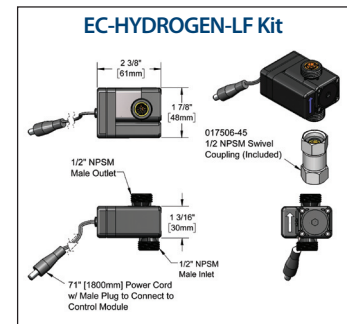

The EC-HYDROGEN-LF Kit

includes a female-to-female ½" NPSM swivel adapter, a hydrogenerator with ½" NPSM inlet and outlet, and attached power cord for connection to the existing sensor faucet control module.

ChekPoint™ Electronic Faucets / Installation Options



- Gang-install up to eight faucets with one power supply, saving installation time and money!
- Available for all ChekPoint Electronic Sensor Faucets

EC-EASYWIRE ChekPoint™ Installation Kit

- 100-240 VAC Plug-in transformer
- 76" long power cord
- Allows up to eight (8) electronic ChekPoint faucets to be ganged to a single power jack
- Requires one EC-EASYWIRE4CC connector per faucet
- Compliant with CEC Appliance Efficiency Regulations CEC-400-2007-016-REV1



EC-EASYWIRE4CC ChekPoint™ Installation Kit

- 4' connector cables for EasyWire AC transformer connections in a daisy chain circuit
- One EC-EASYWIRE4CC connector is needed for each additional faucet in chain



EC-EASYWIRE5EXT ChekPoint™ Installation Kit

- 5' extension cables when additional cable length is needed for connections

EC-HARDWIRE ChekPoint™ Installation Kit

- Electronic AC transformer, input 100-240 VAC, 47-63 Hz
- Terminal block allows you to hardwire up to eight (8) ChekPoint faucets to a single power supply
- Connect to terminals on back of ChekPoint Control Module
- Mounting plate serves as lid for standard size conduit box (box not included)

Note: wiring supplied by others

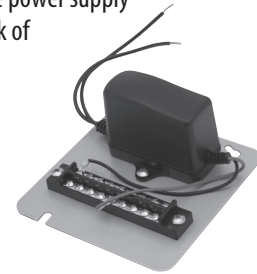

EC-ADEWIRE ChekPoint™ Installation Kit for Above Deck Electronic Faucets (ADE)

- 33' long cable used for EC-HARDWIRE for each Above Deck Electronic (ADE) faucet

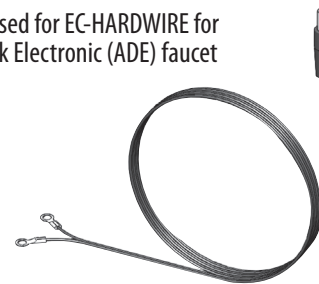

ChekPoint™ Electronic Faucets / Deck Plate Options

Electronic Faucet Deck Plate Part Numbers

- To add a deck plate to an existing ChekPoint Electronic Faucet, order with these part numbers for each EC- faucet model

EC-models	4" Deck Plate	8" Deck Plate
EC-3100	013433-40	013434-40
EC-3101	n/a	n/a
EC-3102	013433-40	013434-40
EC-3103	n/a	n/a
EC-3130	013433-40	013434-40
EC-3132	013433-40	013434-40
EC-3142	013433-40	013434-40

See p. CP8 for more information about deck plates





EC-3100, EC-3101 and EC-3105 Models Gooseneck Options



- You can specify any T&S rigid gooseneck listed below as an option
- These three models have a rigid gooseneck with B-0199-06 vandal-resistant aerator, 2.2 GPM

Rigid Gooseneck



• Rigid gooseneck with various outlets

Note: In order to stay within the full range of the sensor, it is recommended that gooseneck spreads be limited to 6" max.

Rigid Gooseneck/Stream Regulator:
120XM Master Box (6)

Note: See p. ACS 10-11 for other Series 2 outlets for these goosenecks

Model No.	Standard Sizes Spread	Height	Clearance	Outlet	GPM
119X	2-5/8" (67 mm)	8-3/4" (222 mm)	5-1/4" (133 mm)	B-LT Stream Regulator Outlet	-
120X	5-1/2" (140 mm)	10-1/4" (260 mm)	5-1/4" (133 mm)	B-LT Stream Regulator Outlet	-
120X-LAM	5-9/16" (141 mm)	10-1/4" (260 mm)	4-13/16" (122 mm)	B-0199-21 Laminar Flow Device	2.2 GPM
120X-LAM-VR	5-9/16" (141 mm)	10-1/4" (260 mm)	4-3/4" (121 mm)	B-0199-21-VRF VR Laminar Flow Device	2.2 GPM
122X	5-1/2" (140 mm)	11-1/2" (292 mm)	6-1/2" (165 mm)	B-LT Stream Regulator Outlet	-
123X	5-1/2" (140 mm)	12-1/2" (318 mm)	7-1/2" (191 mm)	B-LT Stream Regulator Outlet	-
125X	5-1/2" (140 mm)	14-1/2" (368 mm)	9-1/2" (241 mm)	B-LT Stream Regulator Outlet	-
126X	5-1/2" (140 mm)	15-1/2" (394 mm)	10-1/2" (267 mm)	B-LT Stream Regulator Outlet	-
165X	4-1/16" (103 mm)	9-1/4" (235 mm)	5-13/16" (148 mm)	B-LT Stream Regulator Outlet	-

-LAM Laminar Flow Outlet (2.2 GPM) **-LAM-VR Vandal-Resistant Laminated Flow Device (2.2 GPM)**

EC-3130-LN Model Gooseneck Options



- You can specify any T&S swivel gooseneck listed below as an option
- The standard EC-3130 has a swivel gooseneck (018490-40) with B-0199-06 vandal-resistant aerator, 2.2 GPM

Swivel Gooseneck

- Swivel gooseneck with various outlets

Note: In order to stay within the full range of the sensor, it is recommended that gooseneck spreads be limited to 6" max.



133X

Swivel Gooseneck/Stream Regulator:

- 131XM Master Box (6)
- 132XM Master Box (6)
- 133XM Master Box (6)
- 135XM Master Box (6)

Note: See p. ACS 10-11 for other Series 1 or Series 2 outlets used with these goosenecks

Model No.	Standard Sizes Spread	Height	Clearance	Outlet/Series	GPM
131X	2-15/16" (74 mm)	4-3/4" (121 mm)	2-3/16" (56 mm)	B-PT Stream Regulator (Series 1)	–
131X-A22	2-15/16" (74 mm)	4-3/4" (121 mm)	2-3/16" (56 mm)	B-0199-01 Aerator (Ser. 1)	2.2 GPM
132X	2-7/8" (73 mm)	8-9/16" (217 mm)	5-9/16" (141 mm)	B-LT Stream Regulator (Series 2)	–
132X-A22	2-7/8" (73 mm)	8-9/16" (217 mm)	5-9/16" (141 mm)	B-0199-01 Aerator (Ser. 1)	2.2 GPM
132X-V05	2-7/8" (73 mm)	8-9/16" (217 mm)	5-9/16" (141 mm)	B-0199-06-N05 VR Non-Aer.Spray Device (Ser. 1)	0.5 GPM
133X	5-3/4" (146 mm)	10-5/16" (262 mm)	5-7/8" (150 mm)	B-PT Stream Regulator (Ser. 1)	–
133X-A12	5-3/4" (146 mm)	10-5/16" (262 mm)	5-7/8" (150 mm)	B-0199-01-F12 Aerator (Ser.1)	1.2 GPM
133X-A15	5-3/4" (146 mm)	10-5/16" (262 mm)	5-7/8" (150 mm)	B-0199-01-WS Aerator (Ser. 1)	1.5 GPM
133X-A22	5-3/4" (146 mm)	10-5/16" (262 mm)	5-7/8" (150 mm)	B-0199-01 Aerator (Ser. 1)	2.2 GPM
133X-LAM	5-3/4" (146 mm)	10-5/16" (262 mm)	5-13/16" (148 mm)	B-0199-21 Laminar Flow Device (Ser. 1)	2.2 GPM
133X-LAM-VR	5-3/4" (146 mm)	10-5/16" (262 mm)	5-7/8" (150 mm)	B-0199-21-VRF VR Lam. Flow Device (Ser. 1)	2.2 GPM
133X-V12	5-3/4" (146 mm)	10-5/16" (262 mm)	5-7/8" (150 mm)	B-0199-06-F12 VR Aerator (Ser. 1)	1.2 GPM
133X-V22	5-3/4" (146 mm)	10-5/16" (262 mm)	5-7/8" (150 mm)	B-0199-06 VR Aerator (Ser.1)	2.2 GPM
134X	7-3/4" (197 mm)	11-7/16" (291 mm)	5-1/16" (135 mm)	B-LT Stream Regulator (Ser. 2)	–

-A12 Aerator (1.2 GPM)	-A15 Aerator (1.5 GPM)	-A22 Aerator (2.2 GPM)	-LAM Laminar Flow Device (2.2 GPM)
-LAM-VR Vandal-Resistant Laminated Flow Device (2.2 GPM)		-V05 Vandal-Resistant Non-Aerated Spray Device (0.5 GPM)	
-V12 Vandal-Resistant Aerator (1.2 GPM)		-V22 Vandal-Resistant Aerator (2.2 GPM)	



ChekPoint™ Ware Washing Faucet



ECR-D0810-107
ChekPoint Electronic Rinse Faucet



NEW! ChekPoint electronic faucet with pre-rinse capabilities, designed for specific ware-washing applications

- Chrome plated brass single hole electronic sensor faucet
- Deck-mounted rigid nozzle with ball joint swivel
- B-0107 spray head (1.15 GPM)
- Height: 15" (381 mm)
- Spread: 8" (203 mm)
- Clearance: 10" (254 mm)
- (2) 18" (457 mm) long flexible supply hoses with 3/8" compression fittings
- Other rigid nozzles can be specified
- Other T&S spray outlets can be specified with 1.15 GPM or less; shown with B-0107 and B-0107-C, below, right



ECR-D0810-107

- Features:**
- Reliable and robust below-deck electronics
 - 6 ft. plug-in wall transformer with additional power options available; includes (4) 'AA' batteries
 - Mechanical temperature mixing valve
 - Programmable auto time out, water shut-off delay and auto flush functions
 - Integral filter screens prevent particles from damaging faucet or solenoid valve
 - Integral check valves to prevent back flow and water contamination
 - Anti-rotation pin for positive location on mounting surface



ECR-D0810-107
with B-0107 Spray (1.15 GPM)



ECR-D0810-107
modified with
B-0107-C Spray (0.65 GPM)



RELIABILITY BUILT IN™

G-12

D Institutional, Medical
and Lab Products





Institutional, Medical and Lab Products – D

T&S PRODUCTS featured:

- Updated design of some nozzles, goosenecks, outlets, bonnets, handles and indexes
- Lavatory and Service Sink Faucets all include T&S Eterna cartridges, some with quarter-turn

Single Lever FaucetsD3-6

- Single Lever Faucets, Deck and Side Mount, Centerset, Swivel, Rigid and Gooseneck Assemblies

Lavatory FaucetsD7-32

- NEW DESIGN!** EasyInstall Swivel / Rigid Lavatory Faucets D7-13
- EasyInstall Cast Basin Spout Faucets D14
 - Concealed Widespread Faucets with Adjustable Centers D15-18
 - Lavatory Faucets Swivel/Rigid Gooseneck D19, 20
 - Lavatory Faucets with Cast Basin Spout D21
 - Centerset Faucets with or without Pop-Up Drain Assembly D22
 - Pop-Up Drain Assemblies D23
 - Pivot Action Metering Faucets / Concealed Widespread Pivot Action Faucets D24-25
 - Slow Self-Closing Metering Faucets D26-31
 - Surgical Sink Faucets D32

Pedal Valves, Dummy Goosenecks and BubblersD33-38

- Single and Double Pedal Valves D33-34
 - Knee Valves D34
 - Dummy Goosenecks – Swivel, Rigid D35-37
- NEW!** Bubblers and Bubblers with Water Filtration D38

Service Sink and Sill Faucets D39-50

- Service Sink Faucets with Elevated Vacuum Breakers D39
- Service Sink Faucets with Built-In Stops D39-47
- Service Sink/Mop Sink Faucets and Accessories D48
- Sill and Heavy Duty Sink Faucets D49-50

Bedpan Washers D51-52

Concealed Single Valves D53

Vacuum Breaker Assemblies..... D53

Laboratory Products D54-69

- Lab Hose Cocks and Turrets D54-57
- Remote Control Valve Units D58
- Fume Hood Fittings D59
- Fittings, Support Rods and Accessories D59
- Lab Faucets, Double and Single Ledge, Combination Faucets, Single Temp. Faucets and Lab Accessories D60-66
- Lab Accessories D67-69

Stops and Supplies D69

- Straight and Angle Loose Key Stops

T&S and Water Conservation D70-71

- Aerators and Outlets
- Laminar Flow Outlets and Non-Aerated Spray Devices



- Find this section's Parts and Repair Kits in the **Parts Kits section (G)**.
- Find Outlets and other parts for the models in this section in the **Accessories section (ACS)**.

NOTE:

A comprehensive Index By Model or Part Number and Page can be found in the G-12 General Product Catalog Master Index section (IN).



Can't find the T&S product you're looking for?

Please visit www.tsbrass.com for a complete product listing.

Single Lever Faucets



- All models have:
- Temperature limit stops
 - Ceramic Cartridge with 2-year warranty

B-2711 Single Lever Faucet

- 4" centerset single lever deck mount faucet
- 3-1/2" (89 mm) long handle
- 1/2" NPSM male inlet shanks with coupling nuts
- Ceramic cartridge with adjustable temperature limit stop
- Color coded index
- 1-1/4" (32 mm) max. mounting surface thickness

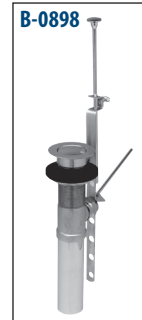

MODEL	CARTRIDGE	HEIGHT	CLEARANCE	SPREAD	OUTLET	GPM	HANDLE	VR	NOTES
B-2710	Ceramic	4-13/16"	2-5/16"	4-3/8"	B-0199-04 Aerator	2.2 GPM	Single lever	N	Pop-up drain assembly (B-0898)
B-2710-F12	Ceramic	4-13/16"	2-5/16"	4-3/8"	B-0199-04-F12 Aerator	1.2 GPM	Single lever	N	Pop-up drain assembly (B-0898)
B-2710-LH	Ceramic	6-7/16"	2-5/16"	4-3/8"	B-0199-04 Aerator	2.2 GPM	5" long single lever	N	Includes 5" long handle and pop-up drain assembly
B-2710-VF05	Ceramic	4-13/16"	2-5/16"	4-3/8"	B-0199-09-N05 VR Spray device	0.5 GPM	Single lever	Y	Includes VR key; pop-up drain assembly
B-2710-VF22	Ceramic	4-13/16"	2-5/16"	4-3/8"	B-0199-09 VR Aerator	2.2 GPM	Single lever	Y	Includes VR key; pop-up drain assembly
B-2710-WS	Ceramic	4-13/16"	2-5/16"	4-3/8"	B-0199-04-WS WaterSense Aerator	1.5 GPM	Single lever	N	Pop-up drain assembly (B-0898)
B-2710-WS-VR	Ceramic	4-13/16"	2-5/16"	4-3/8"	B-0199-09-WS WaterSense Aerator	1.5 GPM	Single lever	Y	Includes VR key; pop-up drain assembly
B-2711	Ceramic	4-13/16"	2-5/16"	4-3/8"	B-0199-04 Aerator	2.2 GPM	Single lever	N	No pop-up drain assembly
B-2711-FL	Ceramic	4-13/16"	2-5/16"	4-3/8"	B-0199-04 Aerator	2.2 GPM	Single lever	N	Includes (2) 18" (457 mm) flex. S/S supply hoses with 3/8" compression fittings; no pop-up drain assembly
B-2711-F12	Ceramic	4-13/16"	2-5/16"	4-3/8"	B-0199-04-F12 Aerator	1.2 GPM	Single lever	N	No pop-up drain assembly
B-2711-LF15	Ceramic	4-13/16"	2-5/16"	4-3/8"	B-0199-09-LF15 VR Laminar Flow	1.5 GPM	Single lever	Y	Includes VR key; no pop-up drain assembly
B-2711-LH	Ceramic	6-7/16"	2-5/16"	4-3/8"	B-0199-04 Aerator	2.2 GPM	5" long single lever	N	Includes 5" long handle; no pop-up drain assembly
B-2711-VF05	Ceramic	4-13/16"	2-5/16"	4-3/8"	B-0199-09-N05 VR Spray device	0.5 GPM	Single lever	Y	Includes VR key; no pop-up drain assembly
B-2711-VF22	Ceramic	4-13/16"	2-5/16"	4-3/8"	B-0199-09 VR Aerator	2.2 GPM	Single lever	Y	Includes VR key; no pop-up drain assembly
B-2711-WS	Ceramic	4-13/16"	2-5/16"	4-3/8"	B-0199-04-WS WaterSense Aerator	1.5 GPM	Single lever	N	No pop-up drain assembly
B-2711-WS-VR	Ceramic	4-13/16"	2-5/16"	4-3/8"	B-0199-09-WS WaterSense Aerator	1.5 GPM	Single lever	Y	Includes VR key; no pop-up drain assembly

VR Vandal-resistant



Single Lever Faucets

- All models have:
- Temperature limit stops
 - Ceramic Cartridge with 2-year warranty

B-2701 Single Lever Faucet

- Single hole, single lever deck mount faucet
- Ceramic cartridge with adjustable temperature limit stop
- 2.2 GPM aerator (B-0199-04)
- 16" (407 mm) flexible stainless steel supply hoses with 3/8" compression fittings



B-2701-VR Same as B-2701 except with vandal-resistant aerator (B-0199-09)

B-2701-VF05 Same as B-2701 except with 0.5 GPM vandal-resistant non-aerated spray device (B-0199-09-N05)

B-2703 Single Lever Faucet

- Single hole, single lever deck mount faucet
- Ceramic cartridge with adjustable temperature limit stop
- 2.2 GPM aerator (B-0199-04)
- 16" (407 mm) long flexible stainless steel supply hoses with 3/8" compression fittings
- 6" wide (4" c/c) forged deck plate (013433-40)



B-2703-LF15 Same as B-2703 except with 1.5 GPM laminar flow device (B-0199-09-LF15)

B-2703-VF05 Same as B-2703 except with 0.5 GPM vandal-resistant non-aerated spray device (B-0199-09-N05)

B-2730 Single Lever Mixing Faucet

- Single lever deck mount faucet
- 9" (229 mm) swivel spout
- Sidespray with 4 ft. hose and hose guide
- 3-1/2" (89 mm) long handle
- (2) 16" long flexible supply hoses with 3/8" compression fittings
- 10" (254 mm) chrome plated deckplate
- Includes center mount installation kit
- Color coded index
- Ceramic cartridge with adjustable temperature limit stop



MODEL	CARTRIDGE	HEIGHT	CLEARANCE	SPREAD	OUTLET	GPM	HANDLE	VR	NOTES
B-2730	Ceramic	7-15/16"	6-13/16"	9-3/16"	B-0199-04 Aerator	2.2 GPM	Single lever	N	Includes sidespray
B-2730-07	Ceramic	7-15/16"	6-13/16"	9-3/16"	B-0199-04 Aerator	2.2 GPM	Single lever	N	7' (2134 mm) hose on sidespray
B-2730-LH	Ceramic	7-15/16"	6-13/16"	9-3/16"	B-0199-04 Aerator	2.2 GPM	5" (127 mm) Long single lever	N	5" (127 mm) long handle and sidespray
B-2730-WS	Ceramic	7-15/16"	6-13/16"	9-3/16"	B-0199-04-WS WaterSense aerator	1.5 GPM	Single lever	N	Includes sidespray
B-2730-WS-VR	Ceramic	7-15/16"	6-13/16"	9-3/16"	B-0199-09-WS VR WaterSense aerator	1.5 GPM	Single lever	Y	Includes sidespray
B-2731	Ceramic	7-15/16"	6-13/16"	9-3/16"	B-0199-04 Aerator	2.2 GPM	Single lever	N	No sidespray
B-2731-LF15	Ceramic	7-15/16"	6-13/16"	9-3/16"	B-0199-09-LF15 VR laminar flow	1.5 GPM	Single lever	Y	No sidespray
B-2731-LH	Ceramic	7-15/16"	6-13/16"	9-3/16"	B-0199-04 Aerator	2.2 GPM	5" (127 mm) Long single lever	N	No sidespray
B-2731-VF05	Ceramic	7-15/16"	6-13/16"	9-3/16"	B-0199-09-N05 VR non-aerated spray	0.5 GPM	Single lever	Y	No sidespray
B-2731-WS	Ceramic	7-15/16"	6-13/16"	9-3/16"	B-0199-04-WS WaterSense aerator	1.5 GPM	Single lever	N	No sidespray
B-2731-WS-VR	Ceramic	7-15/16"	6-13/16"	9-3/16"	B-0199-09-WS VR WaterSense aerator	1.5 GPM	Single lever	Y	No sidespray

VR Vandal-resistant



Single Lever Faucets

All models have: • Temperature limit stops • Ceramic Cartridge with 2-year warranty

B-2740 Side-Mount Faucet

- Side mount faucet with remote on/off control base
- Ceramic cartridge with adjustable temperature limit stop
- 16" (407 mm) long flexible stainless steel supply hoses with 3/8" compression fittings



B-2742 Single Lever Faucet

- Single lever side mount base faucet
- Remote "On-Off" control base
- 5-3/4" swivel gooseneck assembly with 2.2 GPM vandal-resistant aerator (B-0199-06)
- Two (2) 16" (406 mm) long flexible supply hoses with 3/8" compression fittings
- Furnished with vandal-resistant key



B-2742-A22 Same as B-2742 except with 2.2 GPM aerator (133X-A22)

B-2742-LF05 Same as B-2742 except with 0.5 GPM non-aerated spray device (B-0199-01-N05)

B-2742-LH Same as B-2742 except with 5" (127 mm) long handle (013429-45)

B-2742-VF12 Same as B-2742 except with 1.2 GPM VR aerator (133X-V12)

B-2741 Single Lever Faucet

- Single lever side mount base faucet
- Remote "On-Off" control base (B-2740)
- 5-9/16" rigid gooseneck assembly with 2.2 GPM vandal-resistant aerator (B-0199-07)
- Two (2) 16" (406 mm) long flexible supply hoses with 3/8" compression fittings
- Furnished with vandal-resistant key

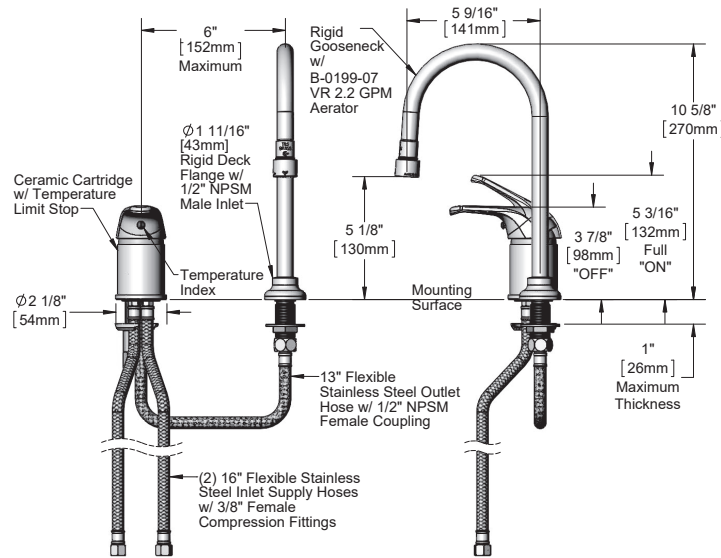



Single Lever Faucets

All models have: • Temperature limit stops • Ceramic Cartridge with 2-year warranty

B-2743 Single Lever Faucet

- Single lever side mount base faucet
- Remote "On-Off" control base
- Swivel gooseneck assembly with 2.2 GPM vandal-resistant aerator (B-0199-06)
- Two (2) 16" (406 mm) long flexible supply hoses with 3/8" compression fittings
- Integral diverter for water flow through sidespray or gooseneck
- Furnished with vandal-resistant key
- Sidespray with 4 ft. hose and hose guide



B-2744 Single Lever Faucet

- Single lever side mount base faucet
- Remote "On-Off" control base
- Rigid gooseneck assembly with 2.2 GPM vandal-resistant aerator (B-0199-06)
- Two (2) 16" (406 mm) long flexible supply hoses with 3/8" compression fittings
- Integral diverter for water flow through sidespray or gooseneck
- Furnished with vandal-resistant key
- Sidespray with 4 ft. hose and hose guide



B-2746 Side-Mount Faucet

- Remote side mount single lever base faucet
- 16" (407 mm) long flexible stainless steel supply hoses with 3/8" compression fittings
- B-2403 high rise swivel gooseneck with 2.2 GPM aerator (B-0199-01)



B-2749 Side-Mount Faucet with Remote Control Base

- Remote side mount single lever base faucet
- 16" (407 mm) long flexible stainless steel supply hoses with 3/8" compression fittings
- Ceramic cartridge with adjustable temperature limit stop
- 5-3/4" swivel gooseneck with 2.2 GPM vandal-resistant aerator (B-0199-06)
- Under the counter vacuum breaker (B-0970-FE) on hose
- Countertop mounted spray valve (002857-40) with 36" stainless steel hose (013E-36H) under the counter



EasyInstall Lavatory Faucets with Swivel/Rigid Gooseneck



All models: **NEW DESIGN** has EasyInstall pre-assembled faucet body for Concealed Widespread Faucets

- Easy installation
- EasyInstall Eterna cartridges with spring checks

B-2850 Lavatory Faucet

EasyInstall



PATENTED DESIGN PATENT NUMBER 7,472,434

- 8" (203 mm) deck mount EasyInstall concealed widespread faucet
- Swivel/rigid gooseneck
- Lever handles with color coded indexes
- 2.2 GPM aerator
- EasyInstall Eterna cartridges with spring checks
- 1/2" NPT male inlets with coupling nuts

MODEL	1/4-Turn CARTRIDGE w/Cross Flow Prevention	GOOSENECK	HEIGHT	CLEARANCE	SPREAD	OUTLET	GPM	HANDLE	VR	NOTES
B-2850	Eterna	133X-A22 Swivel/Rigid	10-11/16"	5-11/16"	5-1/2"	B-0199-01 Aerator	2.2 GPM	Lever	N	
B-2850-01	Eterna	133X-LF15 Swivel/Rigid	10-11/16"	5-3/16"	5-9/16"	B-0199-29 Aerator	1.5 GPM	4" Wrist Action	N	
B-2850-F05	Eterna	Swivel/Rigid	10-11/16"	5-3/16"	5-9/16"	B-0199-02-N05 non-aerated spray device	0.5 GPM	Lever	N	
B-2850-WH4	Eterna	133X-A22 Swivel/Rigid	10-11/16"	5-11/16"	5-1/2"	B-0199-01 Aerator	2.2 GPM	4" Wrist Action	N	
B-2850-WS	Eterna	Swivel/Rigid	10-11/16"	5-3/16"	5-9/16"	B-0199-02-WS WaterSense aerator	1.5 GPM	Lever	N	

Related Models / NOT EASYINSTALL:

B-0850	Eterna	133X-A22 Swivel/Rigid	10-11/16"	5-11/16"	5-1/2"	B-0199-01 Aerator	2.2 GPM	Lever	N	Valves adjustable for angle install.
B-2850-L	Eterna	133X-A22 Swivel/Rigid	10-11/16"	5-11/16"	5-1/2"	B-0199-01 Aerator	2.2 GPM	Lever	N	12" max. adj. faucet centers

VR Vandal-resistant

B-2865-04 Lavatory Faucet

EasyInstall



PATENTED DESIGN PATENT NUMBER 7,472,434

- 8" (203 mm) deck mount EasyInstall concealed widespread faucet
- Swivel/rigid gooseneck
- 2.2 GPM Rosespray outlet (B-0103-01)
- 4" (102 mm) wrist action handles (B-WH4-NS) with color coded indexes
- EasyInstall Eterna cartridges with spring checks
- 1/2" NPT male inlets with coupling nuts

MODEL	1/4-Turn CARTRIDGE w/Cross Flow Prevention	GOOSENECK	HEIGHT	CLEARANCE	SPREAD	OUTLET	GPM	HANDLE	VR	NOTES
B-2865	Eterna	Swivel/Rigid	10-11/16"	5"	5-9/16"	B-0103-01 Rosespray	2.2 GPM	6" Wrist Action	N	
B-2865-04	Eterna	Swivel/Rigid	10-11/16"	5"	5-9/16"	B-0103-01 Rosespray	2.2 GPM	4" Wrist Action	N	
B-2865-04-122X	Eterna	133X-A22 Swivel/Rigid	11-7/8"	6-7/8"	5-1/2"	B-0199-01 Aerator	2.2 GPM	4" Wrist Action	N	
B-2865-LF05	Eterna	Swivel/Rigid	10-11/16"	5-5/8"	5-1/2"	B-PT Stream regulator outlet	0.5 GPM	4" Wrist Action	N	Flow control in gooseneck

VR Vandal-resistant

EasyInstall Lavatory Faucets with Swivel/Rigid Gooseneck

All models: **NEW DESIGN** has EasyInstall pre-assembled faucet body for Concealed Widespread Faucets

- Easy installation
- EasyInstall Eterna cartridges with spring checks

B-2867-04 Lavatory Faucet

EasyInstall

- 8" (203 mm) deck mount EasyInstall concealed widespread faucet
- 2.2 GPM Aerator
- 4" (102 mm) wrist action handles (B-WH4-NS) with color coded indexes
- EasyInstall Eterna cartridges with spring checks
- 1/2" NPT male inlets with coupling nuts



PATENTED
DESIGN
PATENT
NUMBER
7,472,434



MODEL	1/4-Turn CARTRIDGE w/Cross Flow Prevention	GOOSENECK	HEIGHT	CLEARANCE	SPREAD	OUTLET	GPM	HANDLE	VR	NOTES
B-2867	Eterna	133X-A22 Swivel/Rigid	10-11/16"	5-1/8"	5-9/16"	B-0199-01 Aerator	2.2 GPM	6" Wrist Action (B-WH6)	N	
B-2867-04	Eterna	133X-A22 Swivel/Rigid	10-11/16"	5-1/8"	5-9/16"	B-0199-01 Aerator	2.2 GPM	4" Wrist Action (B-WH4-NS)	N	
B-2867-04-F05	Eterna	Swivel/Rigid	10-11/16"	5-1/8"	5-9/16"	B-0199-02-N05 Non-aerated spray device	0.5 GPM	4" Wrist Action (B-WH4-NS)	N	
B-2867-04-LF15	Eterna	133X-L15 Swivel/Rigid	10-11/16"	5-3/16"	5-9/16"	B-0199-29 Laminar flow device	1.5 GPM	4" Wrist Action (B-WH4-NS)	N	
B-2867-04-VF05	Eterna	Swivel/Rigid	10-11/16"	5-3/16"	5-9/16"	B-0199-06-N05 VR non-aerated spray device	0.5 GPM	4" Wrist Action (B-WH4-NS)	Y	
B-2867-04-WS	Eterna	133X-A15 Swivel/Rigid	10-11/16"	5-3/16"	5-9/16"	B-0199-02-WS WaterSense aerator	1.5 GPM	4" Wrist Action (B-WH4-NS)	N	
B-2867-04FC	Eterna	133XP-F15 Swivel/Rigid	9-7/8"	5-1/16"	5-1/2"	Plain end gooseneck	1.6 GPM	4" Wrist Action (B-WH4-NS)	N	1.5 GPM flow control in gooseneck
B-2867-04VRS	Eterna	133X-A22 Swivel/Rigid	10-11/16"	5-3/16"	5-9/16"	B-0199-06 VR Aerator	2.2 GPM	4" Wrist Action (B-WH4-NS)	Y	VR handle screws (VRS-2)

VR Vandal-resistant

B-2868-04 Lavatory Faucet with Pop-Up Valve

EasyInstall

- 8" (203 mm) deck mount EasyInstall concealed widespread faucet
- Swivel/rigid gooseneck
- 2.2 GPM Rosespray outlet (B-0103-01)
- 4" (102 mm) wrist action handles (B-WH4-NS) with color coded indexes
- EasyInstall Eterna cartridges with spring checks
- 1/2" NPT male inlets with coupling nuts
- Pop-up drain assembly (B-0898)



PATENTED
DESIGN
PATENT
NUMBER
7,472,434

B-2869-04 Same as B-2868-04 except with 2.2 GPM aerator outlet (B-0199-01)



EasyInstall Lavatory Faucets with Swivel Gooseneck

All models: **NEW DESIGN** has EasyInstall pre-assembled faucet body for Concealed Widespread Faucets
 • EasyInstall Eterna cartridges with spring checks

B-2347 Lavatory Faucet with Swivel Gooseneck

EasyInstall

- 8" (203 mm) deck mount EasyInstall concealed widespread faucet
- 8-13/16" (224 mm) swivel gooseneck
- 2.2 GPM Rosespray outlet (B-0103)
- 6-5/16" (160 mm) clearance from deck to face of spray
- Sidespray with automatic diverter, 4' flexible reinforced hose and hose guide
- EasyInstall Eterna cartridges with spring checks
- 4" (102 mm) wrist action handles (B-WH4-NS) with color coded indexes
- 1/2" NPT male inlets with coupling nuts

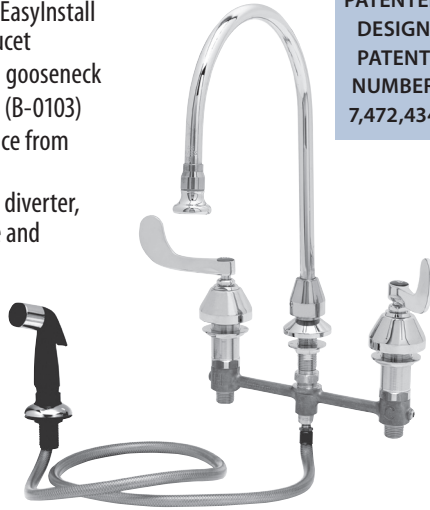

PATENTED DESIGN PATENT NUMBER 7,472,434

B-2347-05-LVR Same as B-2347 except with lever handles and 2.2 GPM aerator

B-2386 Lavatory Faucet with Swivel Gooseneck

EasyInstall

- 8" (203 mm) deck mount EasyInstall concealed widespread faucet
- 5-1/2" (140 mm) swivel gooseneck (010094-40)
- 2.2 GPM aerator-Series 1 (B-0199-01)
- EasyInstall Eterna cartridges with spring checks
- 9-3/4" (248 mm) clearance from deck to outlet
- Lever handles with color coded indexes
- 1/2" NPT male inlets with coupling nuts



PATENTED DESIGN PATENT NUMBER 7,472,434

B-2851 Lavatory Faucet

EasyInstall

- 8" (203 mm) deck mount EasyInstall concealed widespread faucet
- Swivel/rigid gooseneck
- Lever handles with color coded indexes
- 2.2 GPM Aerator (B-0199-01)
- EasyInstall Eterna cartridges with spring checks
- 1/2" NPT male inlets with coupling nuts



PATENTED DESIGN PATENT NUMBER 7,472,434

MODEL	1/4-Turn CARTRIDGE w/Cross Flow Prevention	GOOSENECK	HEIGHT	CLEARANCE	SPREAD	OUTLET	GPM	HANDLE	VR	NOTES
B-2851	Eterna	133X-A22 Swivel/Rigid	10-11/16"	6-5/8"	5-11/16"	B-0199-01 Aerator	2.2 GPM	Lever	N	
B-2851-133X-VR	Eterna	133X-LAM-VR Swivel/Rigid	10-11/16"	6-1/8"	5-3/4"	B-0199-21-VRF VR laminar flow device	2.2 GPM	Lever	Y	VR handle screws (B-VRS)
B-2852	Eterna	135X-A22 Swivel/Rigid	12-3/8"	5-3/8"	8-13/16"	B-0199-02 Aerator	2.2 GPM	Lever	N	
Related Model / NOT EASYINSTALL:										
B-2851-L	Eterna	133X-A22 Swivel/Rigid	10-11/16"	6-9/16"	5-11/16"	B-0199-01 Aerator	2.2 GPM	Lever	N	12" max. adj. faucet centers

VR Vandal-resistant



EasyInstall Lavatory Faucets with Swivel Gooseneck

All models: **NEW DESIGN** has EasyInstall pre-assembled faucet body for Concealed Widespread Faucets
 • Easy installation • EasyInstall Eterna cartridges with spring checks • Lock washer for rigid conversion included

B-2866-04
Lavatory Faucet

EasyInstall



PATENTED
DESIGN
PATENT
NUMBER
7,472,434

- 8" (203 mm) deck mount EasyInstall concealed widespread faucet
- Swivel/rigid gooseneck
- 2.2 GPM Rosespray (B-0103)
- 4" (102 mm) wrist action handles (B-WH4-NS) with color coded indexes
- EasyInstall Eterna cartridges with spring checks
- 1/2" NPT male inlets with coupling nuts

MODEL	1/4-Turn CARTRIDGE w/Cross Flow Prevention	GOOSENECK	HEIGHT	CLEARANCE	SPREAD	OUTLET	GPM	HANDLE	VR	NOTES
B-2862	Eterna	135X-V22 Swivel/rigid	12-3/8"	5-3/8"	8-13/16"	B-0199-02 Aerator	2.2 GPM	4" Wrist Action	N	
B-2862-LF16-WH4	Eterna	Swivel/rigid	14-1/2"	8-1/16"	8-3/4"	Stream regulator outlet	1.6 GPM	4" Wrist Action	N	
B-2862-QT-VR22	Eterna	135X-V22 Swivel/rigid	12-9/16"	5-9/16"	8-13/16"	B-0199-06 VR Aerator	2.2 GPM	4" Wrist Action	Y	
B-2862-VF05	Eterna	Swivel/rigid	12-9/16"	5-3/8"	8-13/16"	B-0199-07-N05 VR non-aerated spray device	0.5 GPM	4" Wrist Action	Y	
B-2862-VF22	Eterna	Swivel/rigid	12-9/16"	5-3/8"	8-13/16"	B-0199-07 VR Aerator	2.2 GPM	4" Wrist Action	Y	
B-2862-WS	Eterna	Swivel/rigid	12-3/8"	5-3/8"	8-13/16"	B-0199-01-WS Aerator	1.5 GPM	4" Wrist Action	N	
B-2866	Eterna	Swivel/rigid	10-11/16"	6"	5-3/4"	B-0103-01 Rosespray	2.2 GPM	6" Wrist Action	N	
B-2866-01QT-VRF	Eterna	Swivel/rigid	12-1/2"	6-5/16"	8-3/4"	B-0199-21-VRF VR Lam. flow device	2.2 GPM	4" Wrist Action	Y	8" inlet centers
B-2866-04	Eterna	Swivel/rigid	10-11/16"	6"	5-3/4"	B-0103 Rosespray	—	4" Wrist Action	N	
B-2866-04-F12	Eterna	Swivel/rigid	10-11/16"	6"	5-3/4"	B-0103-FD12 Rosespray	1.2 GPM	4" Wrist Action	N	
B-2866-04LN	Eterna	—	—	—	—	—	—	4" Wrist Action		Less gooseneck
B-2866-04-01QT	Eterna	179X-A22 Swivel/rigid	9-9/16"	5-15/16"	4-5/16"	B-0199-01 Aerator	2.2 GPM	4" Wrist Action	N	
B-2866-04-QT	Eterna	Swivel/rigid	10-11/16"	6"	5-3/4"	B-0103-01 Rosespray	—	4" Wrist Action	N	
B-2866-04VRS	Eterna	133X-A12 Swivel/rigid	12-3/8"	5-1/2"	8-13/16"	B-0199-07 VR Aerator	2.2 GPM	4" Wrist Action	Y	VR handle screws (VRS-2)
B-2866-F05	Eterna	Swivel/rigid	10-11/16"	6-3/16"	5-3/4"	B-0199-01-N05 non-aerated spray device	0.5 GPM	6" Wrist Action	N	
B-2866-LF12-CR4	Cerama	133X-A12 Swivel/rigid	11-11/16"	7-9/16"	5-11/16"	B-PT Stream regulator outlet	1.2 GPM	4" Wrist Action	N	Flow control in gooseneck
B-2866-QT-21VR	Eterna	133X-LAM-VR Swivel/rigid	10-11/16"	6-3/16"	5-3/4"	B-0199-21-VRF Lam. flow device	2.2 GPM	4" Wrist Action	Y	VR handle screws (VRS-2)
B-2866-QT-VF05	Eterna	Swivel/rigid	10-11/16"	6-3/16"	5-3/4"	B-0199-06-N05 VR non-aerated spray device	0.5 GPM	4" Wrist Action	Y	
B-2866-QT-VF05G	Eterna	Swivel/rigid	10-11/16"	6-3/16"	5-3/4"	B-0199-06-N05 VR non-aerated spray device	0.5 GPM	4" Wrist Action	Y	Includes gaskets for escutcheon & deck flange
B-2866-VF05	Eterna	Swivel/rigid	10-11/16"	6-3/16"	5-3/4"	B-0199-06-N05 VR non-aerated spray device	0.5 GPM	6" Wrist Action	Y	

VR Vandal-resistant



EasyInstall Lavatory Faucets with Swivel/Rigid Gooseneck

All models: **NEW DESIGN** has EasyInstall pre-assembled faucet body for Concealed Widespread Faucets
 • Easy installation • EasyInstall Eterna cartridges with spring checks • Lock washer for rigid conversion included

B-2866-05
 Lavatory Faucet

EasyInstall



PATENTED
 DESIGN
 PATENT
 NUMBER
 7,472,434

- 8" (203 mm) deck mount EasyInstall concealed widespread faucet
- Swivel/rigid gooseneck
- 2.2 GPM aerator (B-0199-01)
- 4" (102 mm) wrist action handles (B-WH4-NS) with color coded indexes
- EasyInstall Eterna cartridges with spring checks
- 1/2" NPT male inlets with coupling nuts

MODEL	1/4-Turn CARTRIDGE w/Cross Flow Prevention	GOOSENECK	HEIGHT	CLEARANCE	SPREAD	OUTLET	GPM	HANDLE	VR	NOTES
B-2866-01	Eterna	135X-A22 Swivel/rigid	12-3/8"	5-15/16"	8-3/4"	B-0199-02 aerator	2.2 GPM	4" Wrist Action	N	
B-2866-01QT-VRF	Eterna	135X-LAM-VR Swivel/rigid	12-1/2"	6-5/16"	8-3/4"	B-0199-21-VRF VR laminar flow device	2.2 GPM	4" Wrist Action	Y	
B-2866-05	Eterna	133X-A22 Swivel/rigid	10-11/16"	6-3/16"	5-3/4"	B-0199-01 aerator	2.2 GPM	4" Wrist Action	N	
B-2866-05-F12	Eterna	Swivel/rigid	12-1/2"	6-5/16"	8-3/4"	B-0103-FD12 Rosespray	1.2 GPM	4" Wrist Action	N	
B-2866-05FC12	Eterna	133XP-F12 Swivel/rigid	10-11/16"	6-5/8"	5-3/4"	Plain end outlet	1.2 GPM	4" Wrist Action	N	Flow control in gooseneck
B-2866-05FC15	Eterna	133XP-F15 Swivel/rigid	10-11/16"	6-5/8"	5-3/4"	Plain end outlet	1.5 GPM	4" Wrist Action	N	Flow control in gooseneck
B-2866-05FC22	Eterna	133XP-F22 Swivel/rigid	10-11/16"	6-5/8"	5-3/4"	Plain end outlet	2.2 GPM	4" Wrist Action	N	Flow control in gooseneck
B-2866-05-LF08	Eterna	133X Swivel/rigid	10-11/16"	6-5/8"	5-3/4"	B-PT Stream regulator outlet	1.6 GPM	4" Wrist Action	N	Flow control in gooseneck
B-2866-05-LF12	Eterna	133X-L12 Swivel/rigid	10-11/16"	6-5/8"	5-3/4"	B-0199-01-LF12 Laminar flow device	1.2 GPM	4" Wrist Action	N	
B-2866-05-LF15	Eterna	133X-L15 Swivel/rigid	10-11/16"	6-3/16"	5-3/4"	B-0199-29 Laminar flow device	1.5 GPM	4" Wrist Action	N	
B-2866-05-QT	Eterna	132X-A22 Swivel/rigid	10-11/16"	6-3/16"	5-3/4"	B-0199-01 aerator	2.2 GPM	4" Wrist Action	N	
B-2866-05-QT-V22	Eterna	133X-V22 Swivel/rigid	10-11/16"	6-3/16"	5-3/4"	B-0199-06 VR aerator	2.2 GPM	4" Wrist Action	Y	
B-2866-05-VF05	Eterna	Swivel/rigid	10-11/16"	6-3/16"	5-3/4"	B-0199-06-N05 VR non-aerated spray device	0.5 GPM	4" Wrist Action	Y	
B-2866-05-VF22	Eterna	133X-V22 Swivel/rigid	10-11/16"	6-3/16"	5-3/4"	B-0199-06 VR aerator	2.2 GPM	4" Wrist Action	Y	
B-2866-05VRS	Eterna	133X-V22 Swivel/rigid	11"	6-7/16"	5-3/4"	B-0199-06 VR aerator	2.2 GPM	4" Wrist Action	Y	
B-2866-05-WS	Eterna	133X-A15 Swivel/rigid	10-11/16"	6-3/16"	5-3/4"	B-0199-01-WS aerator	1.5 GPM	4" Wrist Action	N	

VR Vandal-resistant

Chart cont. next page

EasyInstall Lavatory Faucets with Swivel/Rigid Gooseneck



All models: **NEW DESIGN** has EasyInstall pre-assembled faucet body for Concealed Widespread Faucets
 • Easy installation • EasyInstall Eterna cartridges with spring checks • Lock washer for rigid conversion included

B-2866-05
 Lavatory Faucet

EasyInstall



**PATENTED
 DESIGN
 PATENT
 NUMBER
 7,472,434**

B-2866-05 FAUCETS, cont.

MODEL	1/4-Turn CARTRIDGE w/Cross Flow Prevention	GOOSENECK	HEIGHT	CLEARANCE	SPREAD	OUTLET	GPM	HANDLE	VR	NOTES
B-2866-05CR	Cerama	133X-A22 Swivel/rigid	10-11/16"	6-5/8"	5-11/16"	B-0199-01 aerator	2.2 GPM	4" Wrist Action	N	
B-2866-05CR-F15	Cerama	133XP-F15 Swivel/rigid	10-11/16"	6-11/16"	5-11/16"	Plain end outlet	1.5 GPM	4" Wrist Action	N	Flow control in gooseneck
B-2866-05CR-L15	Cerama	Swivel/rigid gooseneck	10-11/16"	6-1/4"	5-3/4"	B-0199-29 Laminar flow device	1.5 GPM	4" Wrist Action	N	
B-2866-05CRV05	Cerama	Swivel/rigid gooseneck	10-11/16"	6-3/16"	5-3/4"	B-0199-06-N05 VR non-aerated spray device	0.5 GPM	4" Wrist Action	N	
B-2866-05FC	Eterna	133XP-F15 Swivel/rigid	10-11/16"	6-5/8"	5-11/16"	Plain end outlet	1.5 GPM	4" Wrist Action	N	Flow control in gooseneck
B-2866-05FC-CR	Cerama	133XP-F15 Swivel/rigid	10-11/16"	6-5/8"	5-11/16"	Plain end outlet	1.5 GPM	4" Wrist Action	N	Flow control in gooseneck
B-2866-05CRV05	Cerama	Swivel gooseneck	10-11/16"	6-5/8"	5-11/16"	B-0199-06-N05 VR non-aerated spray device	0.5 GPM	4" Wrist Action	N	
B-2866-05FC-PV	Eterna	133XP-F15 Swivel/rigid	10-11/16"	6-5/8"	5-11/16"	Plain end outlet	1.5 GPM	4" Wrist Action	N	Pedal valve connection; Flow control in gooseneck
B-2866-05FC-QT	Eterna	133XP-F15 Swivel/rigid	10-11/16"	6-5/8"	5-11/16"	Plain end outlet	1.5 GPM	4" Wrist Action	N	Flow control in gooseneck
B-2866-05FC10	Eterna	133XP-F10 Swivel/rigid	10-11/16"	6-5/8"	5-11/16"	Plain end outlet	1.0 GPM	4" Wrist Action	N	Flow control in gooseneck
B-2866-05FC15	Eterna	133XP-F15 Swivel/rigid	10-11/16"	6-5/8"	5-11/16"	Plain end outlet	1.5 GPM	4" Wrist Action	N	Flow control in gooseneck
B-2866-05FC22	Eterna	133XP-F22 Swivel/rigid	10-11/16"	6-5/8"	5-11/16"	Plain end outlet	2.2 GPM	4" Wrist Action	N	Flow control in gooseneck
B-2866-05QT-VRS	Eterna	133X-V22 Swivel/rigid	10-11/16"	6-3/16"	5-3/4"	B-0199-06 VR aerator	2.2 GPM	4" Wrist Action	Y	VR handle screws (VRS-2)
B-2866-05QT-WS	Eterna	133X-A15 Swivel/rigid	10-11/16"	6-3/16"	5-3/4"	B-0199-01-WS aerator	1.5 GPM	4" Wrist Action	N	
B-2866-05-WS	Eterna	133X-A15 Swivel/rigid	10-5/8"	6-3/16"	5-3/4"	B-0199-01-WS aerator	1.5 GPM	4" Wrist Action	N	

VR Vandal-resistant

EasyInstall Concealed Widespread Lavatory Faucets



All models: **NEW DESIGN** has EasyInstall pre-assembled faucet body for Concealed Widespread Faucets
 • Easy installation • EasyInstall Eterna cartridges with spring checks • Lock washer for rigid conversion included

B-2855 Lavatory Faucet



- 8" (203 mm) deck mount EasyInstall concealed widespread faucet
- 9" (229 mm) swivel/rigid nozzle (166X)
- 2.2 GPM aerator (B-0199-01)
- Includes lock washers for swivel to rigid conversion (014200-45)
- EasyInstall Eterna cartridges with spring checks
- Lever handles with color coded indexes
- 1/2" NPT male inlets with coupling nuts



B-2885 Lavatory Faucet



- 8" (203 mm) deck mount EasyInstall concealed widespread faucet
- 5-1/2" (140 mm) spread swivel/rigid gooseneck (133X-A22)
- 2.2 GPM aerator (B-0199-01)
- EasyInstall Eterna cartridges with spring checks
- Lever handles with color coded indexes
- Pop-up drain assembly (B-0898)
- 1/2" NPT male inlets with coupling nuts



PATENTED
DESIGN
PATENT
NUMBER
7,472,434

NOTE: See B-2855 chart below:

MODEL	1/4-Turn CARTRIDGE w/Cross Flow Prevention	SWIVEL/RIGID GOOSENECK	HEIGHT	CLEARANCE	SPREAD	OUTLET	GPM	HANDLE	VR
B-2855	Eterna	9" Swing Nozzle (166X)	8-13/16"	6-1/4"	9"	B-0199-01 aerator	2.2 GPM	Lever	N
B-2855-01	Eterna	9" Swing Nozzle (166X)	8-13/16"	5-7/8"	9"	B-0199-29 Laminar flow device	1.5 GPM	Lever	N
B-2855-WS	Eterna	9" Swing Nozzle (166X)	8-13/16"	5-13/16"	9"	B-0199-01-WS aerator	1.5 GPM	Lever	N

VR Vandal-resistant

B-2859 Lavatory Faucet



- 8" (203 mm) deck mount EasyInstall concealed widespread faucet
- 90° swivel/rigid gooseneck (B-2387) with 2.2 GPM aerator (B-0199-01)
- EasyInstall Eterna cartridges with spring checks
- 4" wrist action handles (B-WH4-NS) with color coded indexes
- 1/2" NPT male inlets with coupling nuts



Looking for Nozzles, Aerators, Goosenecks and Handles?
See Our NEW Accessories section in the G-12



EasyInstall Concealed Widespread Lavatory Faucets

All models: **NEW DESIGN** has EasyInstall pre-assembled faucet body for Concealed Widespread Faucets

- Easy installation
- EasyInstall Eterna cartridges with spring checks
- Cast spouts represented only

B-2990 Lavatory Faucet

EasyInstall



- 8" (203 mm) deck mount EasyInstall concealed widespread faucet
- 5-1/4" (133 mm) cast basin spout
- EasyInstall Eterna cartridges with spring checks
- Lever handles with color coded indexes
- 1/2" NPT male inlets with coupling nuts

MODEL	1/4-Turn CARTRIDGE w/ Cross Flow Prevention	HEIGHT	CLEARANCE	SPREAD	OUTLET	GPM	HANDLE	VR	NOTES
B-2990	Eterna	3-1/16"	2"	5-1/4"	B-0199-03 aerator	2.2 GPM	Lever	N	
B-2990-175F	Eterna	3-1/16"	2"	5-1/4"	B-0199-03 aerator	2.2 GPM	Four-arm	N	
B-2990-CW-VR22	Eterna	3-1/16"	2"	5-1/4"	B-0199-08 VR aerator	2.2 GPM	Lever (cold)	Y	Single temperature – cold water
B-2990-F05	Eterna	3-1/16"	2"	5-1/4"	B-0199-03-N05 non-aerated spray device	0.5 GPM	Lever	N	
B-2990-F12	Eterna	3-1/16"	2"	5-1/4"	B-0199-03-F12 aerator	1.2 GPM	Lever	N	
B-2990-P	Eterna	3-1/16"	2"	5-1/4"	B-0199-03 aerator	2.2 GPM	Lever	N	Includes pop-up drain assembly (B-0898)
B-2990-PWH4	Eterna	3-1/16"	2"	5-1/4"	B-0199-03 aerator	2.2 GPM	4" Wrist Action	N	Includes pop-up drain assembly (B-0898)
B-2990-VF05	Eterna	3-1/16"	2"	5-1/4"	B-0199-08-N05 VR non-aerated spray device	0.5 GPM	Lever	Y	
B-2990-WH4	Eterna	3-1/16"	2"	5-1/4"	B-0199-03 aerator	2.2 GPM	4" Wrist Action	N	
B-2990-WH4-F12	Eterna	3-1/16"	2"	5-1/4"	B-0199-03-F12 aerator	1.2 GPM	4" Wrist Action	N	
B-2990-WH4-QT	Eterna	3-1/16"	2"	5-1/4"	B-0199-03 aerator	2.2 GPM	4" Wrist Action	N	
B-2990-WH4-VF22	Eterna	3-1/16"	2"	5-1/4"	B-0199-08 VR aerator	2.2 GPM	4" Wrist Action	Y	
B-2990-WH4-WS	Eterna	3-1/16"	2"	5-1/4"	B-0199-03-WS aerator	1.5 GPM	4" Wrist Action	N	
B-2990-WS	Eterna	3-1/16"	2"	5-1/4"	B-0199-03-WS aerator	1.5 GPM	Lever	N	
Related Model / NOT EASYINSTALL									
B-2990-FL	Eterna	3-1/16"	2"	5-1/4"	B-0199-03 aerator	2.2 GPM	Lever	N	Flexible supply lines; adjustable centers from 6" to 24"

VR Vandal-resistant



Lavatory Faucets with Adjustable Centers

All models have: • 1/2" NPT male inlets with coupling nuts • Valves adjustable for angle installation
• Eterna cartridges with spring checks

B-0865-04 Lavatory Faucet

Note: These faucets are not EasyInstall

- 8" (203 mm) deck mount mixing faucet
- Swivel/rigid gooseneck with 2.2 GPM rosespray outlet
- Adjustable centers (see chart below)
- Eterna cartridges with spring checks
- 4" (152 mm) wrist action handles (B-WH4-NS) with color coded indexes
- 1/2" NPT male inlets with coupling nuts



MODEL	1/4-Turn CARTRIDGE w/Cross Flow Prevention	SWIVEL/RIGID GOOSENECK	HEIGHT	CLEARANCE	SPREAD	OUTLET	GPM	HANDLE	VR	NOTES
B-0865	Eterna	Swivel/rigid	10-11/16"	5"	5-9/16"	B-0103 Rosespray	2.2 GPM	6" Wrist Action	N	8" max. adjustable centers
B-0865-04	Eterna	Swivel/rigid	10-11/16"	5"	5-9/16"	B-0103 Rosespray	2.2 GPM	4" Wrist Action	N	8" max. adjustable centers
B-0865-04-F12	Eterna	Swivel/rigid	10-11/16"	5"	5-9/16"	B-0103 Rosespray	1.2 GPM	4" Wrist Action	N	Swivel deck flange with 1.2 GPM flow disc
B-0865-04L	Eterna	Swivel/rigid	10-11/16"	5"	5-9/16"	B-0103 Rosespray	2.2 GPM	4" Wrist Action	N	12" max. adjustable centers
B-0866	Eterna	Swivel/rigid	10-9/16"	5-15/16"	5-3/4"	B-0103-01 Rosespray	2.2 GPM	6" Wrist Action	N	8" max. adjustable centers
B-0866-04	Eterna	Swivel/rigid	10-9/16"	5-15/16"	5-3/4"	B-0103-01 Rosespray	2.2 GPM	4" Wrist Action	N	8" max. adjustable centers
B-0866-04-CR	Cerama	Swivel/rigid	10-9/16"	5-15/16"	5-3/4"	B-0103-01 Rosespray	2.2 GPM	4" Wrist Action	N	8" max. adjustable centers
B-0866-04L	Eterna	Swivel/rigid	10-9/16"	5-15/16"	5-3/4"	B-0103-01 Rosespray	2.2 GPM	4" Wrist Action	N	12" max. adjustable centers
B-0866-04-LN	Eterna	—	—	—	—	—	—	4" Wrist Action	N	8" max. adjustable centers
B-0866-L	Eterna	Swivel/rigid	10-9/16"	5-15/16"	5-3/4"	B-0103-01 Rosespray	2.2 GPM	6" Wrist Action	N	12" max. adjustable centers
B-0867	Eterna	Swivel/rigid	10-11/16"	5-3/16"	5-1/2"	B-0199-01 aerator	2.2 GPM	6" Wrist Action	N	8" max. adjustable centers
B-0867-04	Eterna	Swivel/rigid	10-11/16"	5-3/16"	5-1/2"	B-0199-01 aerator	2.2 GPM	4" Wrist Action	N	8" max. adjustable centers
B-0867-04L	Eterna	Swivel/rigid	10-11/16"	5-3/16"	5-1/2"	B-0199-01 aerator	2.2 GPM	4" Wrist Action	N	12" max. adjustable centers
B-0867-04-WS	Eterna	Swivel/rigid	10-11/16"	5-3/16"	5-1/2"	B-0199-01-WS aerator	1.5 GPM	4" Wrist Action	N	8" max. adjustable centers

VR Vandal-resistant

B-0868-04 Lavatory Faucet

Note: These faucets are not EasyInstall

- 8" (203 mm) deck mount mixing faucet
- 5-9/16" (141 mm) swivel gooseneck with rosespray outlet (B-0103-01)
- Adjustable centers (see chart on p. D16)
- Eterna cartridges with spring checks
- 1/2" NPT male inlets with coupling nuts
- 4" (152 mm) wrist action handles (B-WH4-NS) with color coded indexes
- Pop-up drain assembly (B-0898)



B-0868-04L Same as B-0868-04 except with 12" (305 mm) adjustable centers
B-0869-04 Same as B-0868-04 except with aerator (B-0199-01)



Lavatory Faucets with Adjustable Centers

- All models have:
- 1/2" NPT male inlets with coupling nuts
 - Valves adjustable for angle installation
 - Eterna cartridges with spring checks (unless Cerama cartridges with check valves)
 - Lock washers

B-0866-PV Lavatory Faucet with PV Connection

Note: This faucet is not EasyInstall

- 8" (203 mm) deck mount mixing faucet
- Swivel/rigid gooseneck with 2.2 GPM rosespray outlet (B-0103-01)
- Adjustable centers (see chart, right)
- 1/2" NPT male inlets with coupling nuts
- Eterna cartridges with spring checks
- 6" (152 mm) wrist action handles (B-WH6-NS) with color coded indexes
- Pedal valve swivel yoke (B-PV)
- 1/2" NPT male inlets with coupling nuts

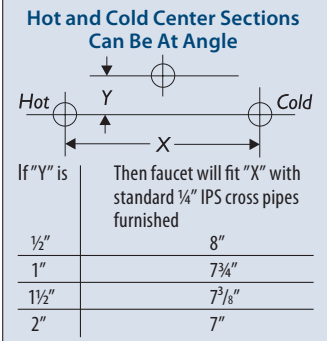

B-0866-07-PV Same as B-0866-PV except with 2.2 GPM aerator (B-0199-01)

B-PV Pedal Valve Swivel Yoke

- For use with all B-0865 style faucets
- Allows faucet to be operated with either wrist action handles or foot pedal valve
- Pedal valve must be ordered separately

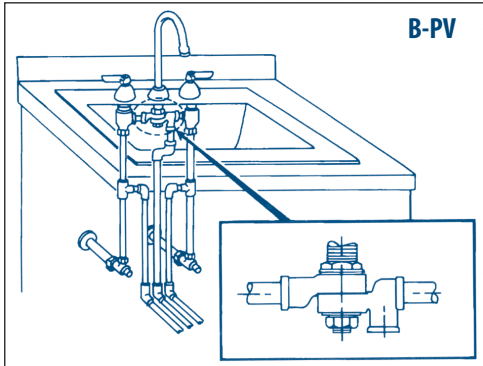

Note: The two faucets below are not EasyInstall

B-0855 Lavatory Faucet

- 8" deck mount mixing swivel joint faucet body for angle installation
- 9" (229 mm) swing/rigid nozzle (166X)
- 2.2 GPM aerator (B-0199-01)
- Adjustable centers (see chart, above)
- Eterna cartridges with spring checks
- Lever handles with color coded indexes
- 1/2" NPT male inlets with coupling nuts



B-0885 Lavatory Faucet

- 8" deck mount mixing swivel joint faucet body for angle installation
- 5-1/2" (140 mm) swivel gooseneck (133X-A22)
- 2.2 GPM aerator (B-0199-01)
- Adjustable centers (see chart, above)
- 6-7/16" (163 mm) clearance from deck to outlet
- Eterna cartridges with spring checks
- Lever handles with color coded indexes
- 1/2" NPT male inlets with coupling nuts
- Pop-up drain assembly (B-0898)

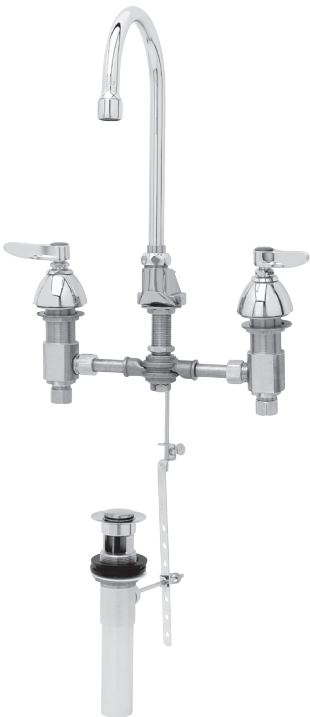



Lavatory Faucets with Adjustable Centers

- All models have:
- 1/2" NPT male inlets with coupling nuts
 - Valves adjustable for angle installation
 - Eterna cartridges with spring checks (unless Cerama cartridges with check valves)
 - Lock washers (for rigid applications)

B-2865-05 Lavatory Faucet

- Adjustable deck mount mixing faucet
- (2) 12" (305 mm) flexible stainless steel hose supplies inlets adjustable from 6" (152 mm) to 24" (609 mm)
- 4" (102 mm) wrist action handles (B-WH4-NS) with color coded indexes
- Eterna cartridges with spring checks
- 1/2" NPT male inlets with coupling nuts

Note: These faucets are not EasyInstall

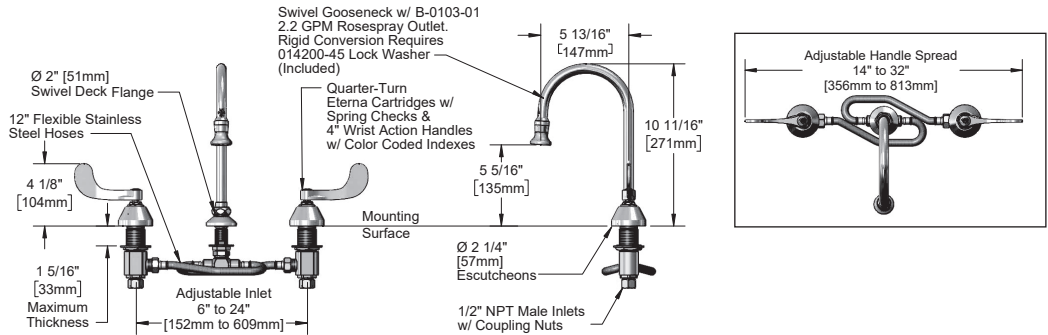

MODEL	1/4-Turn CARTRIDGE w/Cross Flow Prevention	SWIVEL/RIGID	HEIGHT	CLEARANCE	SPREAD	OUTLET	GPM	HANDLE	VR	NOTES
B-2865-04L	Eterna	Swivel/rigid	10-5/8"	4-15/16"	5-9/16"	B-0103-01 Rosespray	2.2 GPM	4" Wrist Action	N	12" max. adjustable faucet centers
B-2865-05	Eterna	Swivel/rigid	10-5/8"	4-15/16"	5-9/16"	B-0103-01 Rosespray	2.2 GPM	4" Wrist Action	N	6" to 24" adjustable spread with 12" flexible stainless steel hoses
B-2865-05-OCS8	Eterna	OCS8 8" Swivel Cast spout	5-7/16"	3-7/8"	8"	B-0199-01 aerator	2.2 GPM	4" Wrist Action	N	6" to 24" adjustable spread with 12" flexible stainless steel hoses
B-2865-05-120XA	Eterna	Swivel/rigid (133X-A22)	10-11/16"	5-3/16"	5-9/16"	B-0199-01 aerator	2.2 GPM	4" Wrist Action	N	6" to 24" adjustable spread with 12" flexible stainless steel hoses
B-2865-05CR	Cerama	Swivel/rigid	10-5/8"	4-15/16"	5-9/16"	B-0103-01 Rosespray	2.2 GPM	4" Wrist Action	N	6" to 24" adjustable spread with 12" flexible stainless steel hoses
B-2865-05CRV05	Cerama	Swivel/rigid	10-5/8"	6-3/16"	5-3/4"	B-0199-06-N05 Non-aerated VR spray device	0.5 GPM	4" Wrist Action	N	6" to 24" adjustable spread with 12" flexible stainless steel hoses
B-2865-05CRV22	Cerama	Swivel/rigid (133X-V22)	10-5/8"	6-3/16"	5-3/4"	B-0199-06 VR aerator	2.2 GPM	4" Wrist Action	N	6" to 24" adjustable spread with 12" flexible stainless steel hoses
B-2865-05CRVL22	Cerama	Swivel/rigid (133X-LAM)	10-5/8"	6-3/16"	5-3/4"	B-0199-21 VR laminar flow device	2.2 GPM	4" Wrist Action	N	6" to 24" adjustable spread with 12" flexible stainless steel hoses
B-2865-09CRV22	Cerama	Swivel/rigid (135X-V22)	12-9/16"	5-9/16"	8-13/16"	B-0199-06 VR aerator	2.2 GPM	4" Wrist Action	N	6" to 24" adjustable spread with 12" flexible stainless steel hoses
B-2865-09CRVL22	Cerama	Swivel/rigid (135X-LAM-VR)	12-5/16"	6-1/8"	8-3/4"	B-0199-21-VRF VR laminar flow device	2.2 GPM	4" Wrist Action	N	6" to 24" adjustable spread with 12" flexible stainless steel hoses
B-2865-06	Eterna	Swivel/rigid	10-5/8"	4-15/16"	5-9/16"	B-0103-01 Rosespray	2.2 GPM	4" Wrist Action	N	6" max. adjustable faucet centers
B-2866-04L	Eterna	Swivel/rigid (133X-A22)	10-11/16"	6-5/8"	5-11/16"	B-0199-01 aerator	2.2 GPM	4" Wrist Action	N	12" adjustable centers
B-2865-06CR	Cerama	Swivel/rigid	10-5/8"	4-15/16"	5-9/16"	B-0103-01 Rosespray	2.2 GPM	4" Wrist Action	N	6" max. adjustable faucet centers
B-2867-04L	Eterna	Swivel/rigid (133X-A22)	10-11/16"	5-5/16"	5-9/16"	B-0199-01 aerator	2.2 GPM	4" Wrist Action	N	12" max. adjustable faucet centers

VR Vandal-resistant

Lavatory Faucets with Adjustable Centers



- All models have:
- 1/2" NPT male inlets with coupling nuts
 - Valves adjustable for angle installation
 - Eterna cartridges with spring checks (unless Cerama cartridges with check valves)

B-2992 Lavatory Faucet

Note: These faucets are not EasyInstall

- 8" deck mount mixing swivel joint faucet body for angle installation
- 5-1/4" (133 mm) cast basin spout
- Eterna cartridges with spring checks
- Lever handles with color coded indexes
- Adjustable centers (see chart, right)
- 2" (51 mm) clearance from deck to aerator
- 1/2" NPT male inlets with coupling nuts

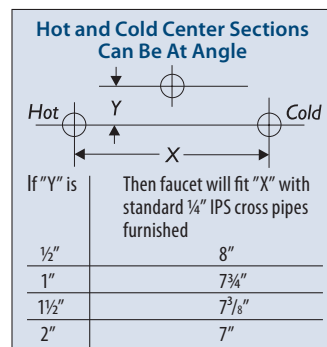

MODEL	1/4-Turn CARTRIDGE w/Cross Flow Prevention	HEIGHT	CLEARANCE	SPREAD	OUTLET	GPM	HANDLE	VR	NOTES
B-2992	Eterna	3-1/16"	2"	5-1/4"	B-0199-03 aerator	2.2 GPM	Lever	N	
B-2992-175F	Eterna	3-1/16"	2"	5-1/4"	B-0199-03 aerator	2.2 GPM	Four-arm handle	N	
B-2992-L	Cerama	3-1/16"	2"	5-1/4"	B-0199-03F-05 flow control aerator	0.5 GPM	4" Wrist Action	N	12" adjustable centers
B-2992-P	Eterna	3-1/16"	2"	5-1/4"	B-0199-03 aerator	2.2 GPM	Lever	N	Includes pop-up waste assembly (B-0898)
B-2992-PWH4	Eterna	3-1/16"	2"	5-1/4"	B-0199-03 aerator	2.2 GPM	4" Wrist Action	N	Includes pop-up waste assembly (B-0898)
B-2992-WH4	Eterna	3-1/16"	2"	5-1/4"	B-0199-03 aerator	2.2 GPM	4" Wrist Action	N	

VR Vandal-resistant

Lavatory Faucets with Swivel/Rigid Gooseneck



- All models have:
- 4" (102 mm) centers
 - 1/2" NPSM male inlets with coupling nuts
 - Fit sinks up to 3/4" (19 mm) thick
 - Lock washers (for rigid applications)

B-0892 Lavatory Faucet

- 4" (102 mm) centerset deck mount mixing faucet
- Swivel/rigid gooseneck
- Quarter-turn Eterna cartridges with spring checks
- 4" (102 mm) wrist action handles (B-WH4-NS) with color coded indexes
- 1/2" NPSM male inlets with coupling nuts
- Lock washers included for rigid applications



B-0893 Same as B-0892 except with pop-up drain assembly (B-0898)

MODEL	1/4-Turn CARTRIDGE w/Cross Flow Prevention	SWIVEL/RIGID GOOSENECK	HEIGHT	CLEARANCE	SPREAD	OUTLET	GPM	HANDLE	VR	NOTES
B-0892	Eterna	Swivel/rigid (132X-A22)	10-7/16"	6-11/16"	2-7/8"	B-0199-01 aerator	2.2 GPM	4" Wrist Action	N	
B-0892-01	Eterna	Swivel/rigid (179X-A22)	10-1/8"	6-3/16"	4-1/8"	B-0199-01 aerator	2.2 GPM	4" Wrist Action	N	
B-0892-01-CR	Cerama	Swivel/rigid (179X-A22)	10-1/8"	6-3/16"	4-1/8"	B-0199-01 aerator	2.2 GPM	4" Wrist Action	N	
B-0892-01-WS	Eterna	Swivel/rigid	10-1/8"	6-3/16"	4-1/8"	B-0199-01-WS WaterSense aerator	1.5 GPM	4" Wrist Action	N	
B-0892-122X-LAM	Eterna	Swivel/rigid (133X-LAM)	12-3/8"	7"	5-9/16"	B-0199-21 laminar flow device	2.2 GPM	4" Wrist Action	N	
B-0892-132XV5CR	Cerama	Swivel/rigid (132X-V05)	10-3/16"	7-3/16"	2-7/8"	B-0199-06-N05 VR non-aerated spray device	0.5 GPM	4" Wrist Action	N	
B-0892-CR	Cerama	Swivel/rigid (132X-A22)	10-7/16"	6-11/16"	2-7/8"	B-0199-01 aerator	2.2 GPM	4" Wrist Action	N	
B-0892-CR-LF05	Cerama	Swivel/rigid	10-7/16"	6-11/16"	2-7/8"	B-0199-01-N05 VR non-aerated spray device	0.5 GPM	4" Wrist Action	N	
B-0892-CR-WS	Cerama	Swivel/rigid	10-7/16"	6-11/16"	2-7/8"	B-0199-01-WS WaterSense aerator	1.5 GPM	4" Wrist Action	N	
B-0892-F05	Eterna	Swivel/rigid	10-7/16"	6-11/16"	2-7/8"	B-0199-01-N05 VR non-aerated spray device	0.5 GPM	4" Wrist Action	N	
B-0892-FC	Eterna	Swivel/rigid	8-15/16"	5-11/16"	2-5/8"	Plain end outlet	1.5 GPM	4" Wrist Action	N	1.5 GPM flow disc in swivel piece
B-0892-F1-CR-SC	Cerama	Swivel/rigid	10-3/8"	6-5/8"	2-7/8"	B-0199-01-F10 aerator	1.0 GPM	4" Wrist Action	N	
B-0892-LF22	Eterna	Swivel/rigid	10-7/16"	6-5/8"	2-7/8"	B-0199-21 Laminar flow device	2.2 GPM	4" Wrist Action	N	
B-0892-M	Eterna	Swivel/rigid	10-7/16"	6-11/16"	2-7/8"	B-0199-01 aerator	2.2 GPM	4" Wrist Action	N	Master carton of 6
B-0892-VF05	Eterna	Swivel/rigid	10-7/16"	6-11/16"	2-7/8"	B-0199-06-N05 VR non-aerated spray device	0.5 GPM	4" Wrist Action	Y	VR handle screws
B-0892-VRS	Eterna	Swivel/rigid	10-3/8"	6-5/8"	2-7/8"	B-0199-06 VR aerator	2.2 GPM	4" Wrist Action	Y	VR handle screws (VRS-2)
B-0892-WS	Eterna	Swivel/rigid	10-7/16"	6-11/16"	2-7/8"	B-0199-01-WS WaterSense aerator	1.5 GPM	4" Wrist Action	N	
B-0893	Eterna	Swivel/rigid	10-7/16"	6-11/16"	2-7/8"	B-0199-01 aerator	2.2 GPM	4" Wrist Action	N	With pop-up waste assembly (B-0898)

VR Vandal-resistant

Lavatory Faucets with Swivel Gooseneck



- All models have:
- 4" (102 mm) centers
 - 1/2" NPSM male inlets with coupling nuts
 - Fit sinks up to 3/4" (19 mm) thick
 - Lock washers (for rigid applications)

B-0892-01QT Lavatory Faucet

- 4" (102 mm) centerset deck mount mixing faucet
- Swivel/rigid gooseneck
- Quarter-turn Eterna cartridges with spring checks or Quarter-turn Cerama cartridges with check valves
- 4" (102 mm) wrist action handles (B-WH4-NS) with color coded indexes
- 1/2" NPSM male inlets with coupling nuts
- Lock washers included for rigid applications



MODEL	1/4-Turn CARTRIDGE w/Cross Flow Prevention	GOOSENECK	HEIGHT	CLEARANCE	SPREAD	OUTLET	GPM	HANDLE	VR	NOTES
B-0892-01CR-L22	Eterna	Swivel	10-5/16"	6-11/16"	4-3/8"	B-0199-21 Laminar flow device	2.2 GPM	4" Wrist Action (B-WH4-NS)	N	
B-0892-133X	Eterna	Swivel (133X)	11-5/16"	6-7/8"	5-3/4"	B-PT stream regulator outlet	—	4" Wrist Action (B-WH4-NS)	N	
B-0892-133XCRWS	Cerama	Swivel (133X-A15)	11-5/16"	6-13/16"	5-3/4"	B-0199-01-WS aerator	1.5 GPM	4" Wrist Action (B-WH4-NS)	N	
B-0892-135X	Eterna	Swivel	13"	6-3/4"	8-3/4"	B-0199-21 Laminar flow device	2.2 GPM	4" Wrist Action (B-WH4-NS)	N	
B-0892-CR-HW	Cerama	Swivel (179X)	10-5/16"	6-11/16"	4-3/8"	B-PT stream regulator outlet	1.2 GPM	4" Wrist Action (B-WH4-NS)	N	1.2 GPM flow control in swivel piece
B-0892-LF12-CR4	Cerama	Swivel (016887-40)	11-5/16"	6-7/8"	5-3/4"	B-PT stream regulator outlet	1.2 GPM	4" Wrist Action (B-WH4-NS)	N	1.2 GPM flow control in swivel piece
B-0892-LN	Eterna	Swivel	—	—	—	Swivel outlet less nozzle	—	4" Wrist Action (B-WH4-NS)	N	
B-0892-QT-F05	Eterna	Swivel	10-5/16"	6-11/16"	4-3/8"	B-0199-01-N05 non-aerated spray device	0.5 GPM	4" Wrist Action (B-WH4-NS)	N	
B-0892-QT-LF16	Eterna	Swivel	10-5/16"	6-11/16"	4-3/8"	B-PT stream regulator outlet	1.5 GPM	4" Wrist Action (B-WH4-NS)	N	1.5 GPM flow control in swivel piece
B-0892-QT-VF05	Eterna	Swivel	10-5/16"	6-5/8"	4-3/8"	B-0199-06-N05 VR non-aerated spray device	0.5 GPM	4" Wrist Action (B-WH4-NS)	Y	VR handle screws (VRS-2)
B-2320	Eterna	Swivel (008978-40)	5-11/16"	3-1/8"	2-15/16"	B-0199-01 aerator	2.2 GPM	Lever	N	

VR Vandal-resistant



Lavatory Faucets with Cast Basin Spout

- All models have:
- 15/16" dia. top shank
 - Fit sinks up to 3/4" (19 mm) thick
 - 1/2" NPSM male inlets with coupling nuts

B-0890 Lavatory Faucet

- 4" (102 mm) centerset deck mount mixing faucet
- 3-3/4" (95 mm) from inlet of faucet to outlet
- 1-7/16" (37 mm) clearance from deck to aerator
- Quarter-turn Eterna cartridges with spring checks or Quarter-turn Cerama cartridges with check valves
- 4" (102 mm) wrist action handles (B-WH4-NS) with color coded indexes
- 1/2" NPSM male inlets with coupling nuts

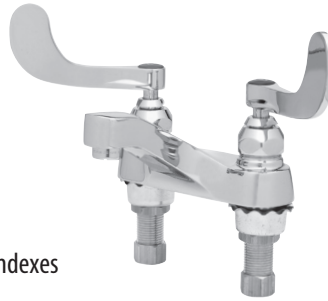

B-0891 Same as B-0890 except with pop-up drain assembly (B-0898)

MODEL	1/4-Turn CARTRIDGE w/Cross Flow Prevention	HEIGHT	CLEARANCE	SPREAD	OUTLET	GPM	HANDLE	VR	NOTES
B-0890	Eterna	4-15/16"	1-7/16"	3-3/4"	B-0199-03 aerator	2.2 GPM	4" Wrist Action (B-WH4-NS)	N	
B-0890-CR	Cerama	4-7/8"	1-7/16"	3-3/4"	B-0199-03 aerator	2.2 GPM	4" Wrist Action (B-WH4-NS)	N	
B-0890-CR-LF05	Cerama	4-7/8"	1-7/16"	3-3/4"	B-0199-03-N05 non-aerated spray device	0.5 GPM	4" Wrist Action (B-WH4-NS)	N	
B-0890-CR-VR05	Cerama	4-7/8"	1-7/16"	3-3/4"	B-0199-08-N05 VR non-aerated spray device	0.5 GPM	4" Wrist Action (B-WH4-NS)	Y	VR handle screws (VRS-2)
B-0890-CR-WS	Cerama	4-7/8"	1-7/16"	3-3/4"	B-0199-03-WS WaterSense aerator	1.5 GPM	4" Wrist Action (B-WH4-NS)	N	
B-0890-F05	Eterna	4-15/16"	1-7/16"	3-3/4"	B-0199-03-N05 non-aerated spray device	0.5 GPM	4" Wrist Action (B-WH4-NS)	N	
B-0890-M	Eterna	4-15/16"	1-7/16"	3-3/4"	B-0199-03 aerator	2.2 GPM	4" Wrist Action (B-WH4-NS)	N	Master carton of 6
B-0890-VF05	Eterna	4-15/16"	1-7/16"	3-3/4"	B-0199-08-N05 VR non-aerated spray device	0.5 GPM	4" Wrist Action (B-WH4-NS)	Y	VR handle screws (VRS-2)
B-0890-VRS	Eterna	4-15/16"	1-7/16"	3-3/4"	B-0199-08 aerator	2.2 GPM	4" Wrist Action (B-WH4-NS)	Y	VR handle screws (VRS-2)
B-0890-WS	Eterna	4-15/16"	1-7/16"	3-3/4"	B-0199-03-WS aerator	1.5 GPM	4" Wrist Action (B-WH4-NS)	N	
B-0891	Eterna	4-15/16"	1-7/16"	3-3/4"	B-0199-03 aerator	2.2 GPM	4" Wrist Action (B-WH4-NS)	N	Pop-up drain assembly (B-0898)
B-0891-F12	Eterna	4-15/16"	1-7/16"	3-3/4"	B-0199-03-F12 aerator	1.2 GPM	4" Wrist Action (B-WH4-NS)	N	Pop-up drain assembly (B-0898)

VR Vandal-resistant

Centerset Faucets with or without Pop-Up Assembly



- All models have:
- 15/16" dia. top shank
 - Fit sinks up to 3/4" (19 mm) thick
 - 1/2" NPSM male inlets with coupling nuts

B-0871 Centerset Lavatory Faucet

- 4" (102 mm) centerset deck mount mixing faucet with cast basin spout
- Eterna cartridges with spring checks
- Lever handles with color coded indexes
- 3-3/4" (95 mm) from inlet of faucet to outlet
- 1-7/16" (27 mm) clearance from deck to aerator



B-0870

B-0870 Same as B-0871 except with pop-up drain assembly
B-0871-M B-0871 Master Box (6)



B-0873 Centerset Lavatory Faucet

- 4" (102 mm) centerset deck mount mixing faucet
- 2-7/8" (73 mm) swivel/rigid gooseneck (132X-A22)
- 2.2 GPM aerator (B-0199-01)
- Eterna cartridges with spring checks
- Lever handles with color coded indexes
- 4-1/16" (103 mm) from center of inlets to center of outlet
- 6-1/2" (16 mm) clearance from deck to aerator
- Pop-up drain assembly (B-0898)
- Lock washers included for rigid applications



B-0874 Same as B-0873 except without pop-up drain assembly
B-0874-M B-0874 Master Box (6)

B-0870 Models:

MODEL	1/4-Turn CARTRIDGE w/Cross Flow Prevention	HEIGHT	CLEARANCE	SPREAD	OUTLET	GPM	HANDLE	VR	NOTES
B-0870	Eterna	3-5/16"	1-7/16"	3-3/4"	B-0199-03 aerator	2.2 GPM	Lever	N	Includes pop-up drain assembly (B-0898)
B-0870-CR	Cerama	3-1/4"	1-7/16"	3-3/4"	B-0199-03 aerator	2.2 GPM	Lever	N	Includes pop-up drain assembly (B-0898)
B-0870-F12	Eterna	3-5/16"	1-7/16"	3-3/4"	B-0199-03-F12 aerator	1.2 GPM	Lever	N	Includes pop-up drain assembly (B-0898)
B-0871	Eterna	3-5/16"	1-7/16"	3-3/4"	B-0199-03 aerator	2.2 GPM	Lever	N	
B-0871-CR	Cerama	3-1/4"	1-7/16"	3-3/4"	B-0199-03 aerator	2.2 GPM	Lever	N	
B-0871-CR-LF05	Cerama	3-1/4"	1-7/16"	3-3/4"	B-0199-03-N05 non-aerated spray device	0.5 GPM	Lever	N	
B-0871-CR-VR05	Cerama	3-1/4"	1-7/16"	3-3/4"	B-0199-08-N05 VR non-aerated spray device	0.5 GPM	Lever	Y	VR handle screws (VRS-2)
B-0871-CR-WS	Cerama	3-1/4"	1-7/16"	3-3/4"	B-0199-03-WS WaterSense aerator	1.5 GPM	Lever	N	
B-0871-F05	Eterna	3-5/16"	1-7/16"	3-3/4"	B-0199-03-N05 non-aerated spray device	0.5 GPM	Lever	N	
B-0871-M	Eterna	3-5/16"	1-7/16"	3-3/4"	B-0199-03 aerator	2.2 GPM	Lever	N	Master carton of 6
B-0871-VF05	Eterna	3-5/16"	1-7/16"	3-3/4"	B-0199-08-N05 non-aerated spray device	0.5 GPM	Lever	Y	VR handle screws (VRS-2)
B-0871-VRS	Eterna	3-5/16"	1-7/16"	3-3/4"	B-0199-08 VR aerator	2.2 GPM	Lever	Y	VR handle screws (VRS-2)
B-0871-VR-CH-QT	Eterna	3-5/16"	1-7/16"	3-3/4"	B-0199-08 VR aerator	2.2 GPM	Club	Y	Club handles with VR handle screws (B-VRS)
B-0871-WS	Eterna	3-5/16"	1-7/16"	3-3/4"	B-0199-03-WS WaterSense aerator	1.5 GPM	Lever	N	

VR Vandal-resistant



Faucet Pop-Up Drain Assemblies

B-0898
Pop-Up Drain Assembly

- Cast brass drain body
- Vandal resistant stopper
- 1-1/4" (32 mm) diameter 17 gage tailpiece
- Fits sinks with 1-7/16" (36 mm) to 1-3/4" (44 mm) diameter drain hole



B-0898-OF
Offset Drain



- ADA compliant
- Polished chrome plated bronze body
- Captive grid
- Fits sinks with 1-7/16" (36 mm) to 1-3/4" diameter drain hole



B-0899
Drain with Grid

- Cast brass polished chrome plated grid
- Fits sinks with 1-7/16" (36 mm) to 1-3/4" diameter drain hole



Pivot Action Metering Faucets

- All models:
- ADA compliant per ANSI A117.1
 - Low force required to activate faucet
 - Load tested to 150 lbs. of force to meet the most demanding applications

B-0712-PA
Pivot Action Metering Faucet

- Single hole single temperature deck mount basin faucet
- Pivot action metering cartridge with adjustable timed flow
- Blank handle and vandal-resistant screw
- 1/2" NPS male shank inlet
- Includes tailpiece and nut for 1/4" NPT connection (150A)
- 4-1/8" (105 mm) center of faucet to outlet
- 7/8" (22 mm) clearance from deck to aerator
- 2.2 GPM aerator (B-0199-02)



B-0800-PA
Pivot Action Metering Wash Sink Single Temperature Faucet

- Single temperature wall mount wash sink metering faucet
- Pivot action metering cartridge with adjustable timed flow
- Blank handle and vandal-resistant screw
- 1/2" NPT female inlet
- Rosespray outlet (B-0103)
- 6-3/4" (171 mm) overall length
- 4" (102 mm) from wall to center of outlet



B-0805-PA
Pivot Action Metering Single Temperature Faucet

- Single hole single temperature deck mount basin faucet
- Pivot action metering cartridge with adjustable timed flow
- Blank handle and vandal-resistant screw
- 1/2" NPSM male inlet with coupling nut
- Fits sinks up to 1" (25 mm) thick
- 4-5/16" (110 mm) center of faucet to outlet
- 1-5/8" (41 mm) clearance from deck to aerator
- 2.2 GPM aerator (B-0199-02)





Pivot Action Metering Faucets



All models: • ADA compliant per ANSI A117.1

• Low force required to activate faucet

B-0807-PA Pivot Action Metering Faucet

- Single hole single temperature deck mount basin faucet
- 18" flexible inlet hoses (compression fittings for 5/8" OD tubing or 1/2" NPSM male thread)
- Pivot action metering cartridge with adjustable timed flow
- Blank handle and vandal-resistant screw
- Fits sinks up to 1-1/4" (32 mm) thick
- 4-5/16" (110 mm) center of faucet to outlet
- 1-5/8" (41 mm) clearance from deck to aerator
- 2.2 GPM aerator (B-0199-02)
- Mechanical temperature mixing valve with integral check valves



B-0831-PA Pivot Action Metering Lavatory Faucet

- 4" (102 mm) centerset deck mount mixing faucet with cast basin spout
- Pivot action metering cartridges with adjustable timed flow and hot and cold handles with vandal-resistant screws
- 3-3/4" (95 mm) from inlet of faucet to outlet
- 2.2 GPM aerator (B-0199-03)
- 1-1/2" (38 mm) clearance from deck to aerator



B-2490-PA Pivot Action Metering Faucet

- Single hole single temperature deck mount basin faucet
- Pivot action metering cartridge with adjustable timed flow and blank handle with vandal-resistant screw
- 2.2 GPM aerator (B-0199-02)
- 18" flexible inlet hoses
- 4-1/8" (105 mm) from center of faucet to center of outlet
- Mechanical temperature mixing valve with integral check valves





Pivot Action Metering Faucets / Concealed Widespread



NEW DESIGN has EasyInstall pre-assembled faucet body for Concealed Widespread Faucets

- Easy installation
- 1/2" O.D. slip inlets
- Teflon seat washers
- 1/2" NPSM coupling nuts

EasyInstall

B-2820-PA Concealed Body Lavatory Faucet

- 8" (203 mm) deck mount EasyInstall concealed widespread faucet
- Pivot action metering cartridges with adjustable timed flow and hot and cold handles with vandal-resistant screws
- 5-3/4" (145 mm) swivel/rigid gooseneck (133X-A22)
- 2.2 GPM aerator (B-0199-01)
- 5-5/8" (143 mm) clearance from deck to tip of outlet
- 1/2" NPSM male inlets with coupling nuts
- Lock washers included for rigid applications



B-2991-PA Pivot Action Metering Valve Lavatory Faucet

- 8" (203 mm) deck mount EasyInstall concealed widespread faucet
- Pivot action metering cartridges with adjustable timed flow and hot and cold handles with vandal-resistant screws
- 5-1/4" (133 mm) cast basin spout
- 2.2 GPM aerator (B-0199-03)
- 2" (51 mm) clearance from deck to aerator
- 1/2" NPSM male inlets with coupling nuts



PATENTED
DESIGN
PATENT
NUMBER
7,472,434



Slow Self-Closing Metering Faucets

- All models:
- Provide adjustable, timed flow of water
 - ADA compliant
 - Vandal resistant
 - Require less than 5 lbs. operating force to open
 - Remain open for 10 seconds minimum

B-0805 Slow Self-Closing Single Temperature Faucet

- Single hole single temperature deck mount faucet
- Slow self-closing metering cartridge with adjustable timed flow
- Blank push button cap with vandal-resistant screw
- 2.2 GPM aerator outlet (B-0199-02)
- 4-15/16" (125 mm) high
- 1-5/8" (42 mm) clearance
- Fits sinks up to 1" thick
- 1/2" NPSM inlet with coupling nuts
- Furnished with spanner bit for vandal-resistant screw
- See chart below for related B-0805 models



B-0800 Slow Self-Closing Wash Sink Single Temperature Faucet

- Single hole single temperature wall mount faucet
- Slow self-closing metering cartridge with adjustable timed flow
- Blank push button cap with vandal-resistant screw
- Rosespray outlet (B-0103)
- 4" (102 mm) spread from wall to center of outlet
- 1/2" NPT female inlet
- Furnished with spanner bit for vandal-resistant screw



B-0805 Models:

MODEL	CARTRIDGE	HEIGHT	CLEARANCE	SPREAD	OUTLET	GPM	HANDLE	VR	NOTES
B-0805	Metering (Slow Self-Closing)	4-15/16"	1-5/8"	4-5/16"	B-0199-02 aerator	2.2 GPM	Push button (Blank)	Y	
B-0805-01	Wrist-action metering (Slow Self-Closing)	8-7/16"	1-5/8"	4-5/16"	B-0199-02 aerator	2.2 GPM	4" Wrist Action	N	Cold index; see inset illustration (above)
B-0805-F05	Metering (Slow Self-Closing)	4-15/16"	1-5/8"	4-5/16"	B-0199-02-N05 non-aerated spray device	0.5 GPM	Push button (Blank)	Y	
B-0805-VF05	Metering (Slow Self-Closing)	4-15/16"	1-5/8"	4-5/16"	B-0199-07-N05 VR spray device	0.5 GPM	Push button (Blank)	Y	
B-0805-VR	Metering (Slow Self-Closing)	5-1/4"	1-7/8"	4-5/16"	B-0199-07 VR aerator	2.2 GPM	Push button (Blank)	Y	4" C/C chrome plated VR deck plate
B-0805-VR-LDP	Metering (Slow Self-Closing)	4-15/16"	1-5/8"	4-5/16"	B-0199-07 VR aerator	2.2 GPM	Push button (Blank)	Y	
B-0805-VR-VF05	Metering (Slow Self-Closing)	5-1/4"	1-7/8"	4-5/16"	B-0199-07-N05 VR non-aerated spray device	0.5 GPM	Push button (Blank)	Y	4" C/C chrome plated VR deck plate
B-0805-WS	Metering (Slow Self-Closing)	4-15/16"	1-1/2"	4-5/16"	B-0199-02-WS WaterSense aerator	1.5 GPM	Push button (Blank)	Y	
B-0806	Metering (Slow Self-Closing)	4-15/16"	1-1/2"	4-3/8"	B-0103 Rosespray	—	Push button (Blank)	Y	
B-0806-VR	Metering (Slow Self-Closing)	5-1/4"	1-13/16"	4-3/8"	B-0103 Rosespray	—	Push button (Blank)	Y	4" C/C chrome plated VR deck plate

VR Vandal-resistant

Slow Self-Closing Metering Faucets

- All models:
- Provide adjustable, timed flow of water
 - ADA compliant
 - Vandal resistant
 - Require less than 5 lbs. operating force to open
 - Remain open for 10 seconds minimum

B-0807 Slow Self-Closing Mixing Faucet

- Single hole single temperature deck mount faucet
- Slow self-closing metering cartridge with adjustable timed flow
- Blank push button cap with vandal-resistant screw
- 2.2 GPM aerator outlet (B-0199-02)
- 3/8" compression female inlets
- Fits sinks up to 1-1/4" (32 mm) thick
- 4-15/16" (125 mm) high
- Mechanical temperature mixing valve with integral check valves

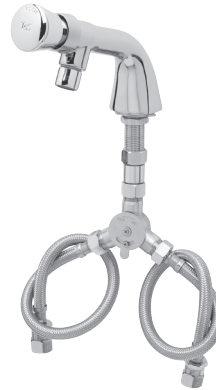

MODEL	CARTRIDGE	HEIGHT	CLEARANCE	SPREAD	OUTLET	GPM	HANDLE	VR	NOTES
B-0807	Metering (Slow Self-Closing)	4-15/16"	1-5/8"	4-5/16"	B-0199-02 aerator	2.2 GPM	Push button (Blank)	Y	
B-0807-01	Wrist Action Metering (Slow Self-Closing)	8-7/16"	1-5/8"	4-5/16"	B-0199-02 aerator	2.2 GPM	4" Wrist Action (Cold index)	N	
B-0807-VR	Metering (Slow Self-Closing)	5-1/4"	1-7/8"	4-5/16"	B-0199-07 VR aerator	2.2 GPM	Push button (Blank)	Y	4" C/C chrome plated VR deck plate
B-0807-WS	Metering (Slow Self-Closing)	4-15/16"	1-5/8"	4-5/16"	B-0199-02-WS aerator	1.5 GPM	Push button (Blank)	Y	WaterSense approved
B-0842	Eterna	8-1/4"	1-5/8"	4-5/16"	B-0199-02 aerator	2.2 GPM	4" Wrist Action (Cold index)	Y	

VR Vandal-resistant

B-0712 Push Button Metering Faucet

- Single hole single temperature deck mount faucet
- Slow self-closing metering cartridge with adjustable timed flow
- Blank push button cap with vandal-resistant screw
- 2.2 GPM aerator outlet (B-0199-02)
- 1/2" NPS male shank
- 4-1/8" (105 mm) center of faucet to center of spout



MODEL	CARTRIDGE	HEIGHT	CLEARANCE	SPREAD	OUTLET	GPM	HANDLE	VR	NOTES
B-0712	Metering (Slow Self-Closing)	4-5/8"	7/8"	4-1/8"	B-0199-02 aerator	2.2 GPM	Push button (Blank)	Y	
B-0712-01VRS	Metering (Slow Self-Closing)	5-1/16"	7/8"	4-1/8"	B-0199-07 VR aerator	2.2 GPM	Lever	Y	VR handle screw (B-VRS)
B-0712-4DP	Metering (Slow Self-Closing)	4-15/16"	1-3/16"	4-1/8"	B-0199-02 aerator	2.2 GPM	Push button (Blank)	Y	4" C/C chrome plated VR deck plate
B-0712-F05	Metering (Slow Self-Closing)	4-5/8"	7/8"	4-1/8"	B-0199-02-N05 non-aerated spray device	0.5 GPM	Push button (Blank)	N	
B-0712-VF05	Metering (Slow Self-Closing)	4-5/8"	7/8"	4-1/8"	B-0199-07-N05 VR non-aerated spray device	0.5 GPM	Push button (Blank)	Y	
B-0712-VF05-4DP	Metering (Slow Self-Closing)	4-15/16"	1-3/16"	4-1/8"	B-0199-07-N05 VR non-aerated spray device	0.5 GPM	Push button (Blank)	Y	4" C/C chrome plated VR deck plate
B-0712-WS	Metering (Slow Self-Closing)	4-5/8"	7/8"	4-1/8"	B-0199-02-WS WaterSense aerator	1.5 GPM	Push button (Blank)	N	
B-0713	Metering (Slow Self-Closing)	4-5/8"	7/8"	4-1/8"	B-0199-07 VR aerator	2.2 GPM	Push button (Blank)	Y	

VR Vandal-resistant



Slow Self-Closing Metering Faucets

- All models: • Provide adjustable, timed flow of water • ADA compliant • Vandal resistant
 • Require less than 5 lbs. operating force to open • Remain open for 10 seconds minimum

B-0831 Slow Self-Closing Centerset Lavatory Faucet

- 4" centerset deck mount mixing faucet with cast basin spout
- Slow self-closing metering cartridges with adjustable timed flow
- Hot and cold push button caps with vandal-resistant screws
- 2.2 GPM aerator outlet (B-0199-03)
- 3-3/4" (95 mm) from inlet of faucet to outlet
- 1-7/16" (37 mm) clearance from deck to aerator
- Includes spanner bit for vandal-resistant screws



MODEL	CARTRIDGE	HEIGHT	CLEARANCE	SPREAD	OUTLET	GPM	HANDLE	VR	NOTES
B-0830	Metering (Slow Self-Closing)	3-7/16"	1-7/16"	3-3/4"	B-0199-03 aerator	2.2 GPM	Push button (H & C)	N	Includes pop-up drain (B-0898)
B-0831	Metering (Slow Self-Closing)	3-7/16"	1-7/16"	3-3/4"	B-0199-03 aerator	2.2 GPM	Push button (H & C)	N	
B-0831-02	Metering (Slow Self-Closing)	3-7/16"	1-7/16"	3-3/4"	B-0199-03-N05 non-aerated spray device	0.5 GPM	Push button (H & C)	N	
B-0831-02VR	Metering (Slow Self-Closing)	3-7/16"	1-7/16"	3-3/4"	B-0199-08-N05 non-aerated spray device	0.5 GPM	Push button (H & C)	Y	
B-0831-F05	Metering (Slow Self-Closing)	3-7/16"	1-7/16"	3-3/4"	B-0199-03-N05 non-aerated spray device	0.5 GPM	Push button (H & C)	N	
B-0831-VF05	Metering (Slow Self-Closing)	3-7/16"	1-7/16"	3-3/4"	B-0199-08-N05 VR non-aerated spray device	0.5 GPM	Push button (H & C)	Y	
B-0831-VR	Metering (Slow Self-Closing)	3-7/16"	1"	3-13/16"	B-0199-08 VR aerator	2.2 GPM	Push button (H & C)	Y	
B-0831-WS	Metering (Slow Self-Closing)	3-7/16"	1-7/16"	3-3/4"	B-0199-03-WS aerator	1.5 GPM	Push button (H & C)	N	

VR Vandal-resistant

B-0833 Slow Self-Closing Centerset Lavatory Faucet with Pop-Up

- 4" centerset deck mount mixing faucet
- Swivel/rigid gooseneck with 2.2 GPM aerator (B-0199-01)
- Slow self-closing metering cartridge with adjustable timed flow
- 4-1/16" (103 mm) from inlet of faucet to outlet
- 6-1/2" (165 mm) clearance from deck to aerator
- 1/2" NPSM inlets with coupling nuts
- Includes pop-up drain assembly (B-0898)
- Includes spanner bit for vandal-resistant screws
- Lock washers included for rigid applications



B-0834 Same as B-0833 except without pop-up assembly (right)
 B-0834-01 Same as B-0834 except with wrist action metering cartridges with 4" (102 mm) handles (shown, below)





Slow Self-Closing Metering Faucets

- All models:
- Provide adjustable, timed flow of water
 - ADA compliant
 - Vandal resistant
 - Require less than 5 lbs. operating force to open
 - Remain open for 10 seconds minimum

B-2490 Slow Self-Closing Metering Valve

- Single hole single temperature deck mount basin faucet
- Slow self-closing metering cartridge with adjustable timed flow and blank push button cap with vandal-resistant screw
- 2.2 GPM aerator (B-0199-02)
- 3/8" compression female inlets
5/8" O.D. tubing or 1/2" NPSM male thread)
- 4-1/8" (105 mm) from center of faucet to center of outlet
- Mechanical temperature mixing valve with integral check valves



B-2490-VF05 Same as B-2490 except with vandal-resistant 0.5 GPM non-aerated spray device
B-2490-VF05-PA Same as B-2490-VF05 except with pivot action metering cartridge/handles

B-2820 Concealed Body Lavatory Faucet

- 8" deck mount EasyInstall concealed widespread faucet
- Slow self-closing metering cartridges with adjustable timed flow
- Hot and cold push button caps with vandal-resistant screws
- 5-3/4" (145 mm) swivel/rigid gooseneck (133X-A22)
- 2.2 GPM aerator (B-0199-01)
- 5-5/8" (143 mm) clearance from deck to tip of outlet
- 1/2" NPT male inlets with coupling nuts
- Lock washers included for rigid applications



Easy Install

PATENTED
DESIGN
PATENT
NUMBER
7,472,434

B-2820-01 Same as B-2820 except with slow close metering cartridges and B-WH4-NS 4" (102 mm) wrist action handles (shown inset, below)

B-2820-01



B-2820-PA Same as B-2820 except with pivot action metering cartridge/handles (see page D25)

B-2821 Concealed Body Lavatory Faucet

Easy Install

- 8" deck mount EasyInstall concealed widespread faucet
- Slow self-closing metering cartridge with adjustable timed flow
- Hot and cold push button caps with vandal-resistant screws
- 5-3/4" Swivel/rigid gooseneck with 2.2 GPM aerator (133X-A22)
- 6-1/2" (165 mm) spread from inlet centers to center of outlet
- 7-3/16" (183 mm) clearance from deck to tip of outlet
- Includes pop-up drain (B-0898)



Slow Self-Closing Metering Faucet with Temperature Adjustment

B-2760-H Temperature Adjustable Metering Faucet

- 4" centerset lavatory faucet with slow-closing metering/temperature selection
- 0.5 GPM aerator saves water
- Brass, bronze, stainless steel parts with heavy-duty cast brass body
- Blade type push button handle requires only 5 lbs. pressure to operate
- Adjustable time flow can be set to less than 30 seconds
- Vandal-resistant design
- Easily adjust water temperature by turning handle; closes automatically when released



Slow Self-Closing Metering Faucets



- All models:
- Provide adjustable, timed flow of water
 - ADA compliant
 - Vandal resistant
 - Require less than 5 lbs. operating force to open
 - Remain open for 10 seconds minimum

B-2991 Lavatory Faucet

Easy Install

- 8" deck mount EasyInstall concealed widespread faucet
- Slow self-closing metering cartridges with adjustable timed flow
- Hot and cold push button caps with vandal-resistant screws
- 5-1/4" (127 mm) cast basin spout
- 2" (51 mm) clearance from deck to aerator
- 1/2" NPSM inlets with coupling nuts
- Includes spanner bit for vandal-resistant screws



MODEL	CARTRIDGE	HEIGHT	CLEARANCE	SPREAD	OUTLET	GPM	HANDLE	VR	NOTES
B-2991	Metering (Slow self-closing)	3-1/16"	2"	5-1/4"	B-0199-03 aerator	2.2 GPM	Push button (H & C)	N	
B-2991-CW-VF05	Metering (Slow self-closing)	3-1/16"	1-15/16"	—	B-0199-08-N05 VR non-aerated spray device	0.5 GPM	Push button (C)	Y	Single temperature – cold water
B-2991-P	Metering (Slow self-closing)	3-1/16"	2"	5-1/4"	B-0199-03 aerator	2.2 GPM	Push button (H & C)	N	Includes pop-up drain (B-0898)
B-2991-PWH4	Metering (Slow self-closing)	4-7/8"	2"	5-1/4"	B-0199-03 aerator	2.2 GPM	4" Wrist Action (B-WH4-NS)	N	Includes pop-up drain (B-0898)
B-2991-VR	Metering (Slow self-closing)	3-1/16"	1-9/16"	5-3/8"	B-0199-08 VR aerator	2.2 GPM	Push button (H & C)	Y	
B-2991-WS	Metering (Slow self-closing)	3-1/16"	2"	5-1/4"	B-0199-03-WS WaterSense aerator	1.5 GPM	Push button (H & C)	N	
B-2823-02	Metering (Slow self-closing)	3-1/16"	1-9/16"	5-3/8"	B-0199-03-N05 aerator with flow control	0.5 GPM	Push button (H & C)	N	

VR Vandal-resistant

Slow Self-Closing Metering Faucets with Wrist Action Handles (-WA)



- All models:
- Provide adjustable, timed flow of water
 - ADA compliant
 - Conserves water
 - Require less than 5 lbs. operating force to open
 - Remain open for 10 seconds minimum

B-0712-WA Wrist Action Metering Faucet

- Single hole single temperature deck mount basin faucet
- Wrist action metering cartridge
- 4" (102 mm) wrist action handle (B-WH4-NS) with cold index
- 1/2" NPSM male inlet
- Includes tailpiece and nut for 1/4" NPT connection
- 4-1/8" (105 mm) center of faucet to center of outlet
- 7/8" (22 mm) outlet clearance
- 2.2 GPM aerator (B-0199-02)
- Metering cartridge conserves water



B-0831-WA Wrist Action Metering Faucet

- 4" centerset deck mount mixing faucet
- Wrist action metering cartridges
- 4" (102 mm) wrist action handles (B-WH4-NS) with color coded indexes
- 1/2" NPSM male inlets
- 1-1/2" (38 mm) outlet clearance
- 3-3/4" (95 mm) center of inlets to center of outlet
- 2.2 GPM aerator (B-0199-03)
- Metering cartridges conserve water

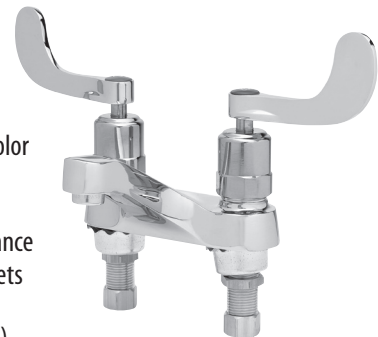

NEW! Slow Self-Closing Metering Faucets with Wrist Action Handles (-WA)



- All models:
- Provide adjustable, timed flow of water
 - ADA compliant
 - Conserves water
 - Require less than 5 lbs. operating force to open
 - Remain open for 10 seconds minimum

B-0892-WA Wrist Action Metering Faucet

- 4" centerset deck mount mixing faucet
- Wrist action metering cartridges conserve water
- 4" (102 mm) wrist action handles (B-WH4-NS)
- 6-1/2" (165 mm) clearance from deck to aerator
- Swivel/rigid gooseneck (132X-A22) with 2.2 GPM aerator (B-0199-01)
- 4-1/16" (103 mm) spread from center of inlets to center of outlet
- 1/2" NPSM male inlets with coupling nuts
- Lock washers included for rigid applications



B-2865-04-WA Wrist Action Metering Faucet

- 8" deck mount EasyInstall concealed widespread faucet
- Wrist action metering cartridges conserve water
- 4" (102 mm) wrist action handles (B-WH4-NS)
- 5-1/2" (140 mm) spread swivel/rigid gooseneck
- 2.2 GPM rosespray outlet (B-0103-01)
- 5" (127 mm) clearance from deck to face of spray
- 1/2" NPSM male inlets with coupling nuts
- Lock washers included for rigid applications

Easy Install



B-2866-05-WA Wrist Action Metering Faucet

- 8" deck mount EasyInstall concealed widespread faucet
- Wrist action metering cartridges conserve water
- 4" (102 mm) wrist action handles (B-WH4-NS)
- 5-3/4" (146 mm) spread swivel/rigid gooseneck
- Includes lock washer for rigid conversion (014200-45)
- 2.2 GPM aerator outlet (B-0199-01)
- 6-1/8" (155 mm) clearance from deck to face of spray
- 1/2" NPSM male inlets with coupling nuts
- Lock washers included for rigid applications

Easy Install



B-2991-WA Wrist Action Metering Faucet

- 8" deck mount EasyInstall concealed widespread faucet
- 5-1/4" (133 mm) cast basin spout with 2.2 GPM aerator outlet (B-0199-03)
- Wrist action metering cartridges conserve water
- 4" (102 mm) wrist action handles (B-WH4-NS)
- Slow self-closing metering cartridges
- 2" (51 mm) clearance from deck to aerator
- 1/2" NPSM male inlets with coupling nuts
- Lock washers included for rigid applications

Easy Install



Looking for Nozzles, Aerators, Goosenecks and Handles?
See Our NEW Accessories section in the G-12



Surgical Sink Faucets

- 8" (203 mm) centers with adjustable inlets
- 4" wrist action handles (B-WH4-NS)

B-0322-04 Surgical Sink Faucet

- 8" deck mount mixing faucet
- 5-3/4" (145 mm) swivel/rigid gooseneck
- Rosespray outlet (B-0103)
- 8-5/8" (219 mm) clearance from deck to rosespray outlet
- 4" (102 mm) wrist action handles (B-WH4-NS)
- Eterna compression cartridges with spring checks
- 1/2" NPT female eccentric flanged inlets (00AA)
- Lock washers included for rigid applications



B-0322 Same as B-0322-04 except with 6" (152 mm) wrist action handles (B-WH6)
B-0323-04 Same as B-0322-04 except with stream regulator outlet (B-LT)

B-0330-04 Surgical Sink Faucet

- 8" wall mount mixing faucet
- 5-3/4" (145 mm) spread swivel/rigid gooseneck (133X)
- Stream regulator outlet (B-PT)
- 4" (102 mm) wrist action handles (B-WH4-NS)
- Eterna compression cartridges with spring checks
- 1/2" NPT female eccentric flanged inlets (00AA)
- 6-3/8" (162 mm) clearance to stream regulator outlet



B-0350-04 Same as B-0330-04 except with rosespray outlet (B-0103-01)
B-0350 Same as B-0350-04 except with 6" (152 mm) wrist action handles (B-WH6)

B-0352-04 Surgical Sink Faucet with Built-In Stops

- 8" wall mount mixing faucet
- 5-3/4" (145 mm) swivel/rigid gooseneck
- Rosespray outlet (B-0103)
- 4-7/16" (113 mm) clearance to sprayface
- 4" (102 mm) wrist action handles (B-WH4-NS)
- Eterna compression cartridges with spring checks
- Built-in screwdriver stops
- 1/2" NPT female eccentric flanged inlets (00AA)



B-0353-04 Same as B-0352-04 except with stream regulator outlet (B-PT)
B-0352 Same as B-0352-04 except with 6" (152 mm) wrist action handles (B-WH6)

B-0355-04 Surgical Sink Faucet with Adjustable Inlet and Loose Key Stops

- 8" wall mount mixing faucet
- 5-3/4" (145 mm) swivel/rigid gooseneck
- Rosespray outlet (B-0103)
- 6-1/8" (156 mm) clearance to rosespray outlet
- 4" (102 mm) wrist action handles (B-WH4-NS)
- Eterna compression cartridges with spring checks
- 1/2" NPT female eccentric flanged inlets with screwdriver stop (00XX)
- Adjustable inlets 3-3/4" (95 mm) to 12-3/4" (319 mm)



Pedal Valves

Note: Pedal valves with metering cartridges recommended for use with higher water pressures or when hammer arrestors are not used.

All models have:

- Self closing valve
- 1/2" NPT inlet and outlet

- Extended pedals (wall mounted models)
- Pedals flip up and stay up for cleaning (wall mounted models)

B-0502 Double Pedal Valve, Floor Mount

- Inlets on 2-7/16" (62 mm) centers
- 1" (25 mm) from floor to center of inlets
- 1/2" NPT female inlets and outlets
- Furnished with two wood mounting screws



B-0502-LKS Same as B-0502 except with loose key stops
B-0502-SL Same as B-0502 except with slow-close metering cartridges

B-0504-01 Double Pedal Valve, Wall Mount

- Inlets on 2-7/16" (62 mm) centers
- 1" (25 mm) from wall to center of inlets
- Wall to pedal tips approximately 13-3/4" (349 mm)
- Angle loose key stops with 1/2" NPT female inlets (B-1350)
- Top mounted loose key angle volume control with 3/8" NPT female outlet (B-1355)

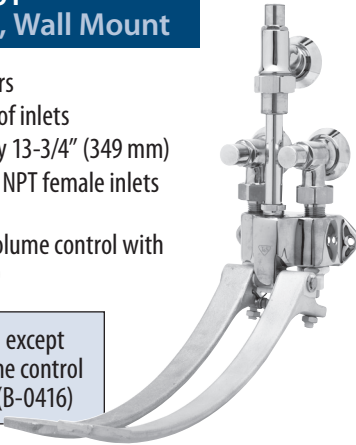

B-0504-02 Same as B-0504-01 except with loose key straight volume control with 1/2" NPT female outlet (B-0416)

B-0507 Single Pedal Valve, Floor Mount

- For hot or cold water
- 1" (25 mm) from floor to center of inlets
- 1/2" NPT female inlet and outlet
- Furnished with two wood mounting screws



B-0508-01 Single Pedal Valve, Wall Mount

- For hot or cold water
- 1" (25 mm) from wall to center of inlet
- Wall to pedal tip approximately 13-3/4" (349 mm)
- Angle loose key stop with 1/2" NPT female inlet (B-1351)
- Angle loose key volume control valve with 3/8" NPT female outlet (B-1355)



B-0504 Double Pedal Valve, Wall Mount

- Inlets on 2-7/16" (62 mm) centers
- 1" (25 mm) from wall to center of outlets
- Wall to pedal tips approximately 13-3/4" (349 mm)
- 1/2" NPT female inlets and outlets
- Furnished with two wood mounting screws



B-0504-LKS Same as B-0504 except with straight loose key stops
B-0504-SL Same as B-0504 except with metering cartridges
B-0504-03 Same as B-0504 except with loose key angle stops
B-0504-03SL Same as B-0504-03 except with metering cartridges

B-0505 Double Pedal Valve, Ledge Mount

- Inlets on 2-7/16" (62 mm) centers
- Polish chrome plated
- 1/2" NPT female inlets and outlets
- Furnished with two wood mounting screws

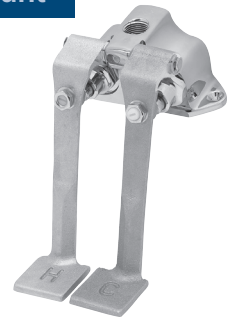

B-0505-SL Same as B-0505 except with metering cartridges

B-0508 Single Pedal Valve, Wall Mount

- For hot or cold water
- 1" (25 mm) from wall to center of inlet
- Wall to pedal tip approximately 13-3/4" (349 mm)
- 1/2" NPT female inlet and outlet

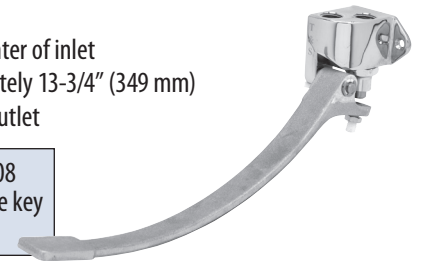

B-0508-LKS Same as B-0508 except with straight loose key stop; see page D34

B-2464 Single Pedal Valve and Rigid Gooseneck Spout

- Single pedal valve (B-0507)
- 5-1/2" rigid gooseneck
- Rosespray outlet (B-0103)
- Rigid deck flange with 1/2" NPSM male inlet
- Includes tailpiece and nut for 1/4" NPT connection (150A)



Pedal Valves

- All models have:
- Self closing valve
 - 1/2" NPT inlet and outlet
 - Extended pedals (wall mounted models)
 - Pedals flip up and stay up for cleaning (wall mounted models)

B-0508-02 Single Pedal Valve, Wall Mount

- For hot or cold water
- 1" (25 mm) from wall to center of inlet
- Wall to pedal tip approximately 13-3/4" (349 mm)
- Angle loose key stop with 1/2" NPT female inlet (B-1351)
- Straight loose key volume control with 1/2" NPT female outlet (B-0416)



B-0508-LKS Single Pedal Valve, Wall Mount

- For hot or cold water
- 1" (25 mm) from wall to center of inlet
- Wall to pedal tip approximately 13-3/4" (349 mm)
- Straight loose key stop with 1/2" NPT female inlet (B-0416)

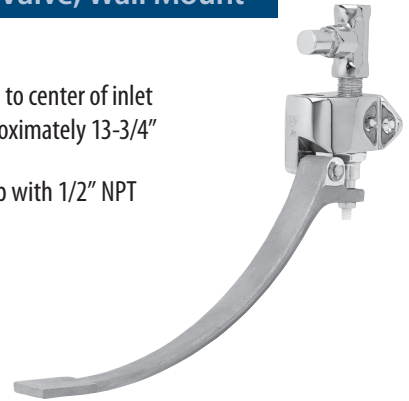

Knee Valves

- All models:
- Feed water automatically
 - Provide sensitive, variable flow control for water conservation

B-0473 Wall Support for Knee Action Valve

- All aluminum, fastens to wall and supports valve body of knee action valve
- Approximately 12" (305 mm) from wall to valve body mounting holes
- 3-1/4" (83 mm) of knee stirrup extends in front of 20" (508 mm) back to front basin
- Can be shortened by cutting aluminum pipe

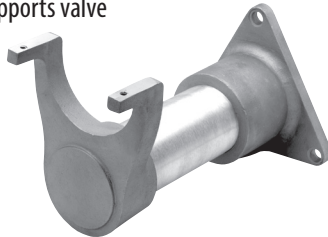

B-0474 Wall Support for Knee Action Valve

- Cast aluminum
- Approximately 11-1/2" (292 mm) from wall to front
- For installation where knee action valve cannot be fastened to horizontal sink support bar
- Bracket supports 1/2" inlet pipes

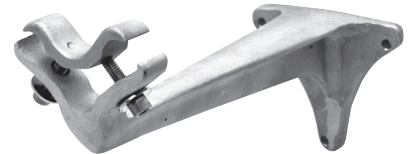

B-0473 Wall Bracket with B-0475 Knee Valve

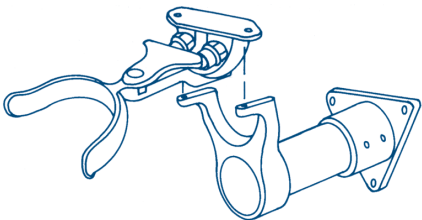

B-0474 Wall Bracket with B-0475 Knee Valve

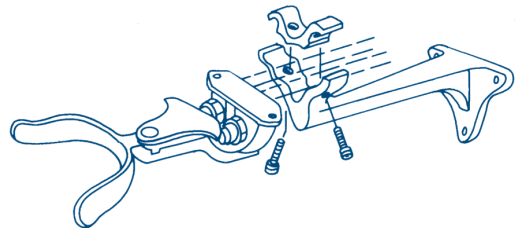

B-0475 Knee Action Valve

- Heavy duty cam acting stirrup
- Valve will remain in set position for hot, cold or mixed water
- 1/2" NPT female inlets
- 2-7/16" (62 mm) centers
- 1/2" NPT female outlet



B-0509 Double Knee Pedal Valve

- Inlets on 2-7/16" (62 mm) centers
- Pedals 6-1/4" (159 mm) long
- Furnished with two wood mounting screws

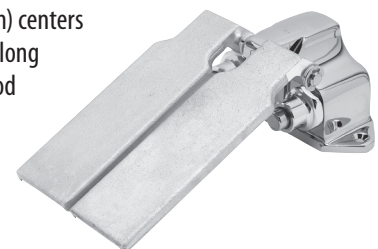

B-0475-LKS Same as B-0475 except with 1/2" NPT straight loose key stops (B-0416)



Dummy Goosenecks - Rigid

B-0520 Rigid Gooseneck Spout

- Deck mount
- 5-1/2" (140 mm) rigid gooseneck (120X)
- Stream regulator outlet (B-LT)
- 10-5/8" (270 mm) high from deck to top of gooseneck
- 5-5/8" (143 mm) clearance from deck to stream regulator outlet
- 1-11/16" (43 mm) dia. rigid deck flange with 1/2" NPSM male inlet
- Mounting nut and washer
- Includes (150A) tailpiece and nut for 1/4" NPT connection



SERIES
2
OUTLETS

MODEL	HEIGHT	CLEARANCE	SPREAD	OUTLET	GPM	VR	NOTES
B-0520	10-5/8"	5-5/8"	5-1/2"	B-LT stream regulator	—	N	120X gooseneck
B-0520-01	5-5/16"	1-3/4"	2-13/16"	B-LT stream regulator	—	N	
B-0520-02	12-7/8"	7-3/16"	5-9/16"	B-0103 rosespray	—	N	123X gooseneck
B-0521	10-5/8"	5-1/8"	5-9/16"	B-0199-02 aerator	2.2 GPM	N	
B-0522	10-5/8"	5-3/8"	5-9/16"	B-0103 rosespray	—	N	
B-0523	11-7/8"	6-3/8"	5-9/16"	B-0199-02 aerator	2.2 GPM	N	122X gooseneck
B-0524	11-7/8"	6-3/16"	5-9/16"	B-0103 rosespray	—	N	122X gooseneck

VR Vandal-resistant

B-0520-F Series Rigid Gooseneck Spout

- Deck mount
- 5-1/2" (140 mm) rigid gooseneck (120X)
- Stream regulator outlet (B-LT)
- Flow control option in shank; **specify desired flow from chart**
- 1-11/16" (43 mm) dia. rigid deck flange with 1/2" NPSM male inlet
- Includes (150A) tailpiece and nut for 1/4" NPT connection

B-0520-F Flow Control Models:

Flow (GPM)	Suffix	Specify
.25	-03	B-0520-F03
.40	-05	B-0520-F05
.70	-07	B-0520-F07
.90	-10	B-0520-F10
1.20	-12	B-0520-F12
1.40	-15	B-0520-F15
2.0	-20	B-0520-F20



SERIES
2
OUTLETS

Dummy Goosenecks - Rigid and Swivel

B-0535 Rigid Gooseneck Spout

- Wall mount
- 3/8" NPT female inlet with 2" (51 mm) dia. flange
- 5-9/16" (141 mm) rigid spread gooseneck
- Rosespray outlet (B-0103)
- 10-5/8" (270 mm) to top of gooseneck
- 4-15/16" (125 mm) clearance from center line of inlet to outlet of rosespray
- 7-13/16" (198 mm) from wall to outlet of rosespray



B-0536 Rigid Gooseneck Spout

- Wall mount
- 1/2" NPT female inlet with 2" (51 mm) dia. flange
- 5-9/16" (141 mm) rigid spread gooseneck
- Rosespray outlet (B-0103)
- 10-5/8" (270 mm) to top of gooseneck
- 4-15/16" (125 mm) clearance from center of inlet to rosespray
- 7-13/16" (198 mm) from wall to outlet of rosespray



B-0525 Swivel Goosenecks and Swing Spouts

- 3/8" NPT female inlet
- B-PT stream regulator outlet
- Adjustable 2" (51 mm) wall flange
- 5-11/16" (145 mm) spread swivel gooseneck (133X)
- 10-5/8" (270 mm) to top of gooseneck
- 6-3/16" (157 mm) clearance from center of inlet to stream regulator outlet



SERIES 1
OUTLETS

B-0526-16
Swing Spout

MODEL	HEIGHT	CLEARANCE	SPREAD	OUTLET	GPM	VR	NOTES
SWING SPOUTS							
B-0526-2	5-5/16"	2-1/4"	6"	B-PT stream regulator outlet	—	N	059X swing nozzle
B-0526-3	5-15/16"	3"	8"	B-PT stream regulator outlet	—	N	060X swing nozzle
B-0526-4	6-5/8"	3-1/2"	10"	B-PT stream regulator outlet	—	N	061X swing nozzle
B-0526-5	7-5/16"	4-3/16"	12"	B-PT stream regulator outlet	—	N	062X swing nozzle
B-0526-16	8-13/16"	5-11/16"	16"	B-PT stream regulator outlet	—	N	064X swing nozzle
SWIVEL GOOSENECKS							
B-0525	10-5/8"	6-3/16"	5-11/16"	B-PT stream regulator outlet	—	N	133X gooseneck
B-0527	10-9/16"	6-1/8"	5-3/4"	B-0199-01 aerator	2.2 GPM	N	133X-A22 gooseneck
B-0528	10-9/16"	5-15/16"	5-3/4"	B-0103-01 rosespray	—	N	—



B-0527
Swivel
Gooseneck

B-0529 Swivel Gooseneck Spout

- Wall mount
- 3/8" NPT female inlet
- Adjustable 2" (51 mm) dia. wall flange
- 2-15/16" (75 mm) spread swivel gooseneck
- 2.2 GPM aerator (B-0199-01)
- 4-15/16" (125 mm) to top of gooseneck
- 2-3/8" (60 mm) clearance from center of inlet to aerator



SERIES 1
OUTLETS

B-0529-01 Swivel Gooseneck Spout

- Wall mount
- 3/8" NPT female inlet
- Adjustable 2" (51 mm) dia. wall flange
- 2-7/8" (73mm) spread swivel gooseneck (132X)
- B-PT stream regulator outlet
- 5-13/16" (148 mm) clearance from center line of inlet to outlet of stream regulator
- 8-13/16" (224 mm) to top of gooseneck



SERIES 2
OUTLETS

Dummy Goosenecks - Swivel

B-0545-F Series Swivel Gooseneck Spout

- Deck mount
- 5-11/16" (144 mm) plain end swivel gooseneck (133XP)
- Plain end spout, laminar flow, no threaded outlet
- Flow control in shank; **specify desired flow from chart**
- 10-5/8" (270 mm) high from deck to top of gooseneck
- 6-5/8" (170 mm) clearance from deck to stream regulator outlet
- 1-3/4" (44 mm) dia. swivel deck flange with 1/2" NPSM male inlet
- Mounting nut and washer
- Includes (150A) tailpiece and nut for 1/4" NPT connection

B-0545-F Flow Control Models:

Flow (GPM)	Suffix	Specify
.90	-10	B-0545-F10
1.20	-12	B-0545-F12
1.40	-15	B-0545-F15
2.0	-20	B-0545-F20



MODEL	HEIGHT	CLEARANCE	SPREAD	OUTLET	GPM	VR	NOTES
B-0545-F15-LW	10-5/8"	6-5/8"	5-11/16"	Plain end spout (133XP)	1.40 GPM	N	Swivel gooseneck converts to rigid with furnished lock washer (014200-45)

VR Vandal-resistant

B-0546 Swivel Gooseneck Spout

- Deck mount
- 5-3/4" (145 mm) swivel gooseneck (133X-LAM)
- 2.2 GPM laminar flow outlet (B-0199-21)
- 10-5/8" (270 mm) high from deck to top of gooseneck
- 6-3/16" (157 mm) clearance from deck to outlet
- 1-3/4" (44 mm) dia. swivel deck flange with 1/2" NPSM male inlet (B-0431)
- Mounting nut and washer
- Includes (150A) tailpiece and nut for 1/4" NPT connection



B-0546



B-0546-133X-AER



B-0546-133XLF15

MODEL	HEIGHT	CLEARANCE	SPREAD	OUTLET	GPM	VR	NOTES
B-0546	10-5/8"	6-3/16"	5-3/4"	B-0199-21 Laminar flow device	2.2 GPM	N	
B-0546-133X	10-5/8"	6-3/16"	5-3/4"	B-PT stream regulator outlet	—	N	133X gooseneck; swivel gooseneck converts to rigid with furnished lock washer (014200-45)
B-0546-133X-AER	10-5/8"	6-3/16"	5-3/4"	B-0199-01 aerator	2.2 GPM	N	133X-A22 swivel gooseneck; swivel gooseneck converts to rigid with furnished lock washer (014200-45)
B-0546-133XLF15	10-5/8"	6-3/16"	5-3/4"	B-0199-29 laminar flow device	1.5 GPM	N	Swivel gooseneck converts to rigid with furnished lock washer (014200-45)

VR Vandal-resistant

Bubblers

Antimicrobial Handles Available

B-2360 Bubbler



- Polished chrome plated bubbler
- Flexible mouth guard
- Fast self-closing cartridge with lever handle and vandal-resistant screw
- Hidden flow control
- 1/2" NPSM shank and coupling nut
- Threaded holes on bottom flange accept anti-rotation pins



B-2360-02 Same as B-2360 except with removable anti-rotation pins and forged brass mouth guard
B-2360-04 Same as B-2360-02 except with 3" x 4" backing plate
B-2360-AR Same as B-2360 except with anti-rotation pins

B-2360-01-PA Bubbler with Pivot Action Metering Valve

- Polished chrome plated bubbler
- Pivot action metering cartridge
- Flexible mouth guard
- Hidden flow control
- 1/2" NPSM shank and coupling nut
- Threaded holes on bottom flange accept anti-rotation pins



B-2360-01 Bubbler

- Flexible mouth guard
- Push-button metering cartridge
- Hidden flow control
- 1/2" NPSM shank and coupling nut
- Threaded holes on bottom flange accept anti-rotation pins



B-2360-01-AR Same as B-2360-01 except with anti-rotation pins
B-2360-03 Same as B-2360-01 except with forged brass mouth guard and removable anti-rotation pins

Bubblers with Water Filtration

NEW! T&S Glass Fillers, Bubblers and Water Stations with Everpure water filtration system

- Provides filtered tap water to ensure good-tasting, odor-free and contaminant-free water in your facility

B-2360-WFK Bubbler with Water Filtration

- B-2360 Bubbler with:**
- Flexible mouth guard
 - Fast self-closing cartridge with lever handle and vandal-resistant screw
 - Hidden flow control
 - 1/2" NPSM shank and coupling nut
 - Threaded holes on bottom flange accept anti-rotation pins (not included)

- Water Filtration:**
 Includes B-WFK docking station, filter cartridge and all necessary installation components:
- (1) 3/8" street elbow (148X)
 - (2) 3/8" NPT x 3/8" compression male adapters (006101-45)
 - (1) 20" polymer braided inlet hose 3/8" compression (013146-45)
 - (1) 18" stainless steel braided connector hose 3/8" compression x 1/2" NPSM (5EF-0005)
 - (2) mounting screws
 - Replaceable filter cartridge (B-WFC)

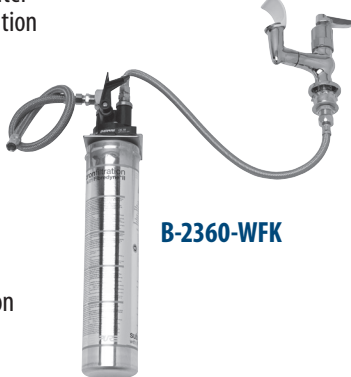

B-2360-WFK

B-2360-01-WFK Bubbler with Water Filtration

- B-2360-01 Bubbler with:**
- Flexible mouth guard
 - Push-button metering cartridge
 - Hidden flow control
 - 1/2" NPSM shank and coupling nut
 - Threaded holes on bottom flange accept anti-rotation pins (not included)

- Water Filtration:**
 Includes B-WFK docking station, filter cartridge and all necessary installation components:
- (1) 3/8" street elbow (148X)
 - (2) 3/8" NPT x 3/8" compression male adapters (006101-45)
 - (1) 20" polymer braided inlet hose 3/8" compression (013146-45)
 - (1) 18" stainless steel braided connector hose 3/8" compression x 1/2" NPSM (5EF-0005)
 - (2) mounting screws
 - Replaceable filter cartridge (B-WFC)



B-2360-01-WFK

Service Sink Faucets

- Built-in screwdriver stops (on select models) allow water shut-off for maintenance on faucet, such as removal and replacing Eterna cartridges
- Internal spring checks (on select models) prevent crossflow and back flow of water

B-0491-01 Service Sink Faucet with Elevated Vacuum Breaker



- 5' elevated atmospheric vacuum breaker
- 6-3/16" (156 mm) service sink spout with garden hose male thread outlet and pail hook
- Furnished with top spout brace and (2) B-0110 wall brackets
- 1/2" NPT female flanged adjustable arm inlets with screwdriver stop (00XX)
- Adjustable inlet centers from 2-1/4" (57 mm) to 8-1/4" (210 mm)

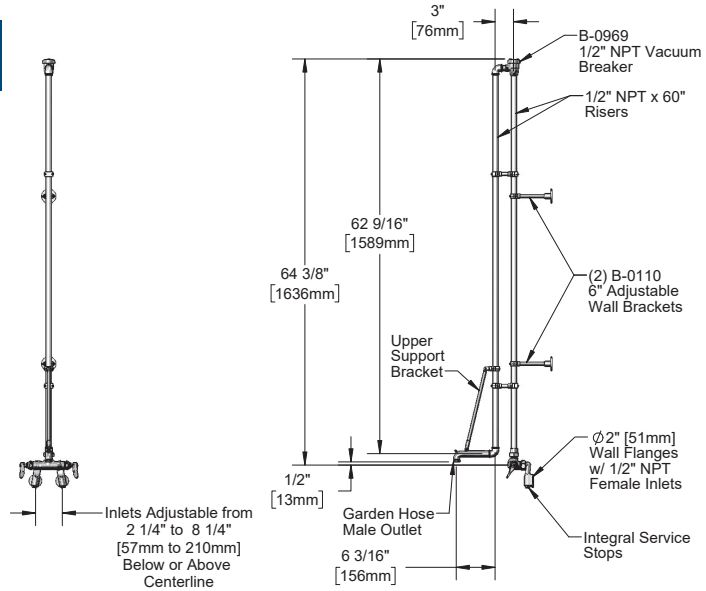

B-0650-BSTP Service Sink Faucet

- 8" wall mount service sink faucet
- Built-in screwdriver stops in faucet body
- Polished chrome plated finish
- Eterna cartridges with spring checks
- Lever handles with color coded indexes
- Plain end spout with pail hook
- 5-7/16" (138 mm) clearance wall to center line of faucet
- 12-1/16" (306 mm) from wall to center of outlet
- Lower wall support with mounting screws
- 1/2" NPT female eccentric flanged inlets with extensions (B-0441)



MODEL	1/4-Turn CARTRIDGE w/Cross Flow Prevention	OUTLET	CLEARANCE WALL TO FAUCET	WALL TO OUTLET	HANDLE	INLET FLANGES	FINISH	NOTES
B-0650-BSTP	Eterna	Plain end spout	5-7/16"	12-1/16"	Lever	1/2" NPT female eccentric flanged inlets w/ extensions (B-0441)	Polished chrome	Built-in stops
B-0650-01	Eterna	Plain end spout	2-13/16"	9-7/16"	6" Wrist-Action	1/2" NPT female adj. arm w/ screwdriver stops (00XX)	Polished chrome	
B-0650-02	Eterna	Plain end spout	8-1/2"	14-7/8"	6" Wrist-Action	1/2" NPT female adj. arm w/ screwdriver stops (00XX)	Polished chrome	(2) 2-3/4" long inlet extensions (000610-25)
B-0650-BSTR	Eterna	Plain end spout	5-7/16"	12-1/8"	Lever	1/2" NPT female eccentric flanged inlets w/ extensions (B-0441)	Rough chrome	Built-in stops
B-0650-POL	Eterna	Plain end spout	5-1/8"	11-3/4"	Lever	1/2" NPT female eccentric flanged inlets w/ extensions (B-0441)	Polished chrome	
B-0650-RGH	Eterna	Plain end spout	5-1/8"	11-3/4"	Lever	1/2" NPT female eccentric flanged inlets w/ extensions (B-0441)	Rough chrome	



Service Sink Faucets

B-0655-01 Service Sink Faucet

- 8" wall mount service sink faucet
- Polished chrome plated finish
- Eterna cartridges with spring checks
- 6" (152 mm) wrist-action handles with color coded indexes
- Atmospheric vacuum breaker spout with 3/4" garden hose male thread and pail hook
- 9-3/16" (233 mm) from wall to center of outlet
- Lower wall support with mounting screws
- 1/2" NPT female adjustable arm inlets with screwdriver stops (00XX)



MODEL	1/4-Turn CARTRIDGE w/Cross Flow Prevention	OUTLET	CLEARANCE WALL TO FAUCET	WALL TO OUTLET	HANDLE	INLET FLANGES	FINISH	NOTES
B-0655-01	Eterna	3/4" Garden hose	2-3/4"	9-3/16"	6" Wrist-Action	1/2" NPT female adj. arm w/ screwdriver stops (00XX)	Polished chrome	Integral supply stops; 1/2" NPT vacuum breaker (B-0969)
B-0655-02	Eterna	3/4" Garden hose	8-1/4"	14-11/16"	6" Wrist-Action	Extended 1/2" NPT female adj. arm w/ screwdriver stops	Polished chrome	Integral supply stops; 1/2" NPT vacuum breaker (B-0969); extended inlets
B-0655-03	Eterna	3/4" Garden hose	5-1/2"	11-15/16"	6" Wrist-Action	Extended 1/2" NPT female adj. arm w/ screwdriver stops	Polished chrome	Integral supply stops; 1/2" NPT vacuum breaker (B-0969); extended inlets
B-0655-04	Eterna	3/4" Garden hose	8-1/4"	14-11/16"	6" Wrist-Action	Extended 1/2" NPT female adj. arm w/ screwdriver stops	Polished chrome	Upper wall support rod; 1/2" NPT vacuum breaker (B-0969); extended inlets
B-0652	Eterna	Plain end spout	9-1/2"	15-15/16"	6" Wrist-Action	Extended 1/2" NPT female adj. arm w/ screwdriver stops	Polished chrome	Integral supply stops; extended inlets

B-0655-BSTP Service Sink Faucet

- 8" wall mount service sink faucet
- Polished chrome plated finish
- Eterna cartridges with spring checks
- Lever handles with color coded indexes
- Atmospheric vacuum breaker spout with 3/4" garden hose male thread and pail hook
- 5-7/16" (138 mm) clearance from wall to center line of faucet
- 11-7/8" (302 mm) from wall to center of outlet
- Lower wall support with mounting screws
- Built-in screwdriver stops in faucet body
- 1/2" NPT female eccentric flanged inlets with extensions (B-0441)



MODEL	1/4-Turn CARTRIDGE w/Cross Flow Prevention	OUTLET	CLEARANCE WALL TO FAUCET	WALL TO OUTLET	HANDLE	INLET FLANGES	FINISH	NOTES
B-0655-BSTP	Eterna	3/4" Garden hose	5-7/16"	11-7/8"	Lever	1/2" NPT female eccentric flanged inlets w/ extensions (B-0441)	Polished chrome	Built-in stops; 1/2" NPT atmospheric vacuum breaker (B-0969)
B-0655-BSTP-CR	Cerama	3/4" Garden hose	5-7/16"	11-7/8"	Lever	1/2" NPT female eccentric flanged inlets w/ extensions (B-0441)	Polished chrome	Cerama cartridges w/check valves; built-in stops; 1/2" NPT atmospheric vacuum breaker (B-0969)
B-0655-BSTR	Eterna	3/4" Garden hose	5-7/16"	11-7/8"	Lever	1/2" NPT female eccentric flanged inlets w/ extensions (B-0441)	Rough chrome	1/2" NPT atmospheric vacuum breaker (B-0969); built-in stops
B-0655-POL	Eterna	3/4" Garden hose	5-1/8"	11-5/8"	Lever	1/2" NPT female eccentric flanged inlets w/ extensions (B-0441)	Polished chrome	1/2" NPT atmospheric vacuum breaker (B-0969)
B-0655-RGH	Eterna	3/4" Garden hose	5-1/8"	11-5/8"	Lever	1/2" NPT female eccentric flanged inlets w/ extensions (B-0441)	Rough chrome	1/2" NPT atmospheric vacuum breaker (B-0969)
B-0656-POL	Eterna	3/4" Garden hose	5-1/8"	11-9/16"	Lever	1/2" NPT female inlets w/ loose key stops & extensions (00JJ-XT)	Polished chrome	1/2" NPT atmospheric vacuum breaker (B-0969)
B-0656-RGH	Eterna	3/4" Garden hose	5-1/8"	11-9/16"	Lever	1/2" NPT female inlets w/ loose key stops & extensions (00JJ-RGH)	Rough chrome	1/2" NPT atmospheric vacuum breaker (B-0969)



Service Sink Faucets

B-0657 Service Sink Faucet

- 8" wall mount service sink faucet
- Polished chrome plated finish
- Eterna cartridges with spring checks
- B-WH6 6" (152 mm) wrist-action handles with color coded indexes
- Atmospheric vacuum breaker spout with 3/4" garden hose male thread and pail hook
- 5-1/8" (130 mm) clearance from wall to center line of faucet
- 11-9/16" (294 mm) from wall to center of outlet
- 1/2" NPT female inlets with loose key stops and extensions (00JJ-XT)
- Lower wall support with mounting screws

B-0657-01 Same as B-0657 except with upper wall support
B-0657-BST Same as B-0657 except with 1/2" NPT female eccentric inlets with extensions and built-in stops in body



B-0660-POL Service Sink Faucet

- 8" wall mount service sink faucet
- Polished chrome plated finish
- Eterna cartridges with spring checks
- Lever handles with color coded indexes
- Spout with plain outlet and pail hook
- 9-1/8" (231 mm) from wall to center of outlet
- Upper wall support with mounting screws
- 2-3/8" (60 mm) from wall to center line of faucet
- 1/2" NPT female eccentric flanged inlets (00AA)



MODEL	1/4-Turn CARTRIDGE w/Cross Flow Prevention	OUTLET	CLEARANCE WALL TO FAUCET	WALL TO OUTLET	HANDLE	INLET FLANGES	FINISH	NOTES
B-0660-POL	Eterna	Plain end spout	2-3/8"	9"	Lever	1/2" NPT female eccentric (00AA)	Polished chrome	
B-0660-BSTP	Eterna	Plain end spout	2-11/16"	9-5/16"	Lever	1/2" NPT female eccentric (00AA)	Polished chrome	Built-in stops in faucet body
B-0660-BSTR	Eterna	Plain end spout	2-11/16"	9-5/16"	Lever	1/2" NPT female eccentric (00AA)	Rough chrome	Built-in stops in faucet body
B-0660-RGH	Eterna	Plain end spout	2-3/8"	9"	Lever	1/2" NPT female eccentric (00AA)	Rough chrome	
B-0661-POL	Eterna	Plain end spout	3-3/8"	10"	Lever	1/2" NPT female w/loose key stops (00JJ)	Polished chrome	
B-0661-RGH	Eterna	Plain end spout	3-3/8"	10"	Lever	1/2" NPT female w/loose key stops (00JJ-RGH)	Rough chrome	



Service Sink Faucets

- Built-in screwdriver stops (on select models) allow water shut-off for maintenance on faucet, such as removal and replacing Eterna cartridges
- Internal spring checks prevent crossflow and back flow of water

B-0662 Service Sink Faucet with Ceiling Supply

- 8" wall supported ceiling mount service sink faucet
- Polished chrome plated finish
- Designed for exposed ceiling supply lines
- Eterna cartridges with spring checks
- Lever handles with color coded indexes
- Atmospheric vacuum breaker spout with 3/4" garden hose male thread and pail hook
- 1/2" NPT female inlets with integral supply stops (00JJ)
- Includes four (B-0110) pipe supports for ceiling supplies
- Upper wall support with mounting screws
- 1/2" supply pipes supplied by others

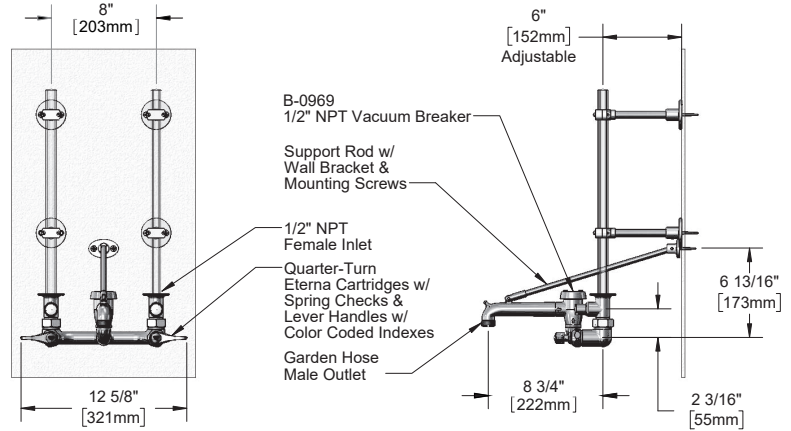

B-0664 Service Sink Faucet

- 8" wall mount service sink faucet
- Polished chrome plated finish
- Eterna cartridges with spring checks
- 6" wrist action handles (B-WH6) with color coded indexes
- Spout with 3/4" garden hose male threads outlet and pail hook
- 9-11/16" (246 mm) from wall to center of outlet
- 3-3/8" (86 mm) from wall to center of faucet
- Lower wall support with mounting screws
- 1/2" NPT female inlets with loose key supply stops (00JJ)



MODEL	1/4-Turn CARTRIDGE w/Cross Flow Prevention	OUTLET	CLEARANCE WALL TO FAUCET	WALL TO OUTLET	HANDLE	INLET FLANGES	FINISH	NOTES
B-0664	Eterna	3/4" Garden hose	3-3/8"	9-11/16"	6" Wrist-Action	1/2" NPT female inlets w/ loose key supply stops (00JJ)	Polished chrome	Lower wall support
B-0664-01	Eterna	Plain end spout	7-7/8"	14-3/16"	6" Wrist-Action	1/2" NPT female inlets w/ loose key supply stops and extensions	Polished chrome	Lower wall support
B-0664-02	Eterna	Plain end spout	5-1/8"	11-7/16"	6" Wrist-Action	1/2" NPT female inlets w/ loose key supply stops and extensions (00JJ-XT)	Polished chrome	Lower wall support
B-0664-03	Eterna	3/4" Garden hose	7-7/8"	14-5/16"	4" Wrist-Action	1/2" NPT female inlets w/ loose key supply stops and extensions	Polished chrome	B-0969 1/2" vacuum breaker; split ring bottom support adjustable clamp assembly fastens to 1-1/2" O.D. flush tube
B-0664-05	Eterna	3/4" Garden hose	7-7/8"	14-5/16"	6" Wrist-Action	1/2" NPT female inlets w/ loose key supply stops and extensions	Polished chrome	B-0969 1/2" vacuum breaker; split ring top support adjustable clamp assembly fastens to 1-1/2" O.D. flush tube



Service Sink Faucets

- Built-in screwdriver stops (on select models) allow water shut-off for maintenance on faucet, such as removal and replacing Eterna cartridges
- Internal spring checks prevent crossflow and back flow of water

B-0665-BSTP Service Sink Faucet

- 8" wall mount service sink faucet
- Polished chrome plated finish
- Eterna cartridges with spring checks
- Lever handles with color coded indexes
- Built in screwdriver stops
- Atmospheric vacuum breaker spout with 3/4" garden hose male thread and pail hook
- Upper wall support with mounting screws
- 2-11/16" (68 mm) clearance from wall to center line of faucet
- 9-1/8" (232 mm) from wall to center of outlet
- 1/2" NPT female eccentric flanged inlets (00AA)



MODEL	1/4-Turn CARTRIDGE w/Cross Flow Prevention	OUTLET	CLEARANCE WALL TO FAUCET	WALL TO OUTLET	HANDLE	INLET FLANGES	FINISH	NOTES
B-0665-BSTP	Eterna	3/4" Garden hose male	2-11/16"	9-1/8"	Lever	1/2" NPT female eccentric (00AA)	Polished chrome	1/2" NPT atmospheric vacuum breaker (B-0969); built-in stops
B-0665-BSTP-963	Eterna	3/4" Garden hose male	2-11/16"	11-1/4"	Lever	1/2" NPT female eccentric (00AA)	Polished chrome	1/2" NPT vacuum breaker (B-0963); built-in stops
B-0665-BSTP-CVB	Eterna	3/4" Garden hose male	2-11/16"	9"	Lever	1/2" NPT female eccentric (00AA)	Polished chrome	Dual check valve vacuum breaker (B-0975); built-in stops
B-0665-BSTP-VRS	Eterna	3/4" Garden hose male	2-11/16"	9-1/8"	Lever	1/2" NPT female eccentric (00AA)	Polished chrome	Vandal-resistant screws on handles (VRS-2); built-in stops
B-0665-BSTPM	Eterna	3/4" Garden hose male	2-11/16"	9-1/8"	Lever	1/2" NPT female eccentric (00AA)	Polished chrome	B-0665-BSTP Master carton of 6
B-0665-BSTPM24	Eterna	3/4" Garden hose male	2-11/16"	9-1/8"	Lever	1/2" NPT female eccentric (00AA)	Polished chrome	B-0665-BSTP Master carton of 24
B-0665-BSTR	Eterna	3/4" Garden hose male	2-11/16"	9-1/8"	Lever	1/2" NPT female eccentric (00AA)	Rough chrome	1/2" NPT atmospheric vacuum breaker (B-0969); built-in stops
B-0665-BSTR-963	Eterna	3/4" Garden hose male	2-11/16"	11-1/4"	Lever	1/2" NPT female eccentric (00AA)	Rough chrome	1/2" NPT vacuum breaker (B-0963); built-in stops
B-0665-BSTR-CVB	Eterna	3/4" Garden hose male	2-11/16"	9"	Lever	1/2" NPT female eccentric (00AA)	Rough chrome	Dual check valve vacuum breaker (B-0975); built-in stops
B-0665-BSTRM	Eterna	3/4" Garden hose male	2-11/16"	9-1/8"	Lever	1/2" NPT female eccentric (00AA)	Rough chrome	B-0665-BSTR Master carton of 6
B-0665-BSTRM12	Eterna	3/4" Garden hose male	2-11/16"	9-1/8"	Lever	1/2" NPT female eccentric (00AA)	Rough chrome	B-0665-BSTR Master carton of 12
B-0665-BSTRM24	Eterna	3/4" Garden hose male	2-11/16"	9-1/8"	Lever	1/2" NPT female eccentric (00AA)	Rough chrome	B-0665-BSTR Master carton of 24
B-0665-CR-BSTP	Cerama	3/4" Garden hose male	2-11/16"	9-1/8"	Lever	1/2" NPT female eccentric (00AA)	Polished chrome	Cerama cartridges w/check valves; 1/2" NPT atmospheric vacuum breaker (B-0969); built-in stops
B-0665-CR-BSTR	Cerama	3/4" Garden hose male	2-11/16"	9-1/8"	Lever	1/2" NPT female eccentric (00AA)	Rough chrome	Cerama cartridges w/check valves; 1/2" NPT atmospheric vacuum breaker (B-0969); built-in stops
B-0665-CR-POL	Cerama	3/4" Garden hose male	2-3/8"	8-7/8"	Lever	1/2" NPT female eccentric (00AA)	Polished chrome	Cerama cartridges; 1/2" NPT atmospheric vacuum breaker (B-0969)
B-0665-POL	Eterna	3/4" Garden hose male	2-3/8"	8-7/8"	Lever	1/2" NPT female eccentric (00AA)	Polished chrome	1/2" NPT atmospheric vacuum breaker (B-0969)

Chart cont. next page



Service Sink Faucets

- Built-in screwdriver stops (on select models) allow water shut-off for maintenance on faucet, such as removal and replacing Eterna cartridges
- Internal spring checks prevent crossflow and back flow of water

B-0665-BSTP Service Sink Faucet



B-0665-BSTP FAUCETS, cont.

MODEL	1/4-Turn CARTRIDGE w/Cross Flow Prevention	OUTLET	CLEARANCE WALL TO FAUCET	WALL TO OUTLET	HANDLE	INLET FLANGES	FINISH	NOTES
B-0665-RGH	Eterna	3/4" Garden hose male	2-3/8"	8-7/8"	Lever	1/2" NPT female eccentric (00AA)	Rough chrome	1/2" NPT atmospheric vacuum breaker (B-0969)
B-0666-POL	Eterna	3/4" Garden hose male	3-3/8"	9-13/16"	Lever	1/2" NPT female inlets w/ loose key stops (00JJ)	Polished chrome	1/2" NPT atmospheric vacuum breaker (B-0969)
B-0666-RGH	Eterna	3/4" Garden hose male	3-3/8"	9-13/16"	Lever	1/2" NPT female with integral stops (00JJ-RGH)	Rough chrome	1/2" NPT atmospheric vacuum breaker (B-0969)
B-0658	Eterna	3/4" Garden hose male	3-3/8"	9-13/16"	6" wrist-action	1/2" NPT female with integral stops (00JJ)	Polished chrome	1/2" NPT atmospheric vacuum breaker (B-0969)
B-1958	Eterna	3/4" Garden hose male	5-1/16"	11-9/16"	4-Arm	1/2" NPT female with integral stops and extensions (00JJ-XT-RGH)	Rough chrome	1/2" NPT atmospheric vacuum breaker (B-0969)

B-0667-POL Service Sink Faucet

- Wall mount service sink faucet
- Polished chrome plated finish
- 1/2" NPT female flanged adjustable arm inlets with screwdriver stops (00XX)
- Adjustable centers from 2-1/4" (57 mm) to 8-1/4" (210 mm)
- Eterna cartridges with spring checks
- Lever handles with color coded indexes
- Atmospheric vacuum breaker nozzle with 3/4" garden hose thread and pail hook
- Top support wall brace with mounting screws
- 9-9/16" (243 mm) clearance from back of inlets to center of outlet



MODEL	1/4-Turn CARTRIDGE w/Cross Flow Prevention	OUTLET	CLEARANCE WALL-FAUCET	WALL TO OUTLET	HANDLE	INLET FLANGES	FINISH	NOTES
B-0667-POL	Eterna	3/4" Garden hose male	3-1/16"	9-9/16"	Lever	1/2" NPT female flanged adj. arm inlets screwdriver stops (00XX)	Polished chrome	1/2" NPT atmospheric vacuum breaker (B-0969)
B-0667-POLM	Eterna	3/4" Garden hose male	3-1/16"	9-9/16"	Lever	1/2" NPT female flanged adj. arm inlets screwdriver stops (00XX)	Polished chrome	B-0667-POL Master carton of 6
B-0667-RGH	Eterna	3/4" Garden hose male	3-1/16"	9-9/16"	Lever	1/2" NPT female flanged adj. arm inlets screwdriver stops (00XX-RGH)	Rough chrome	1/2" NPT atmospheric vacuum breaker (B-0969)
B-0667-RGHM	Eterna	3/4" Garden hose male	3-1/16"	9-9/16"	Lever	1/2" NPT female flanged adj. arm inlets screwdriver stops (00XX-RGH)	Rough chrome	B-0667-RGH Master carton of 6
B-0667-RGHM24	Eterna	3/4" Garden hose male	3-1/16"	9-9/16"	Lever	1/2" NPT female flanged adj. arm inlets screwdriver stops (00XX-RGH)	Rough chrome	B-0667-RGH Master carton of 24
B-0668-POL	Eterna	3/4" Garden hose male	3-1/16"	9-9/16"	Lever	1/2" NPT female flanged adj. arm inlets (00GG)	Polished chrome	
B-0668-RGH	Eterna	3/4" Garden hose male	3-1/16"	9-9/16"	Lever	1/2" NPT female flanged adj. arm inlets (00GG-RGH)	Rough chrome	



Service Sink and Sill Faucets

- Built-in screwdriver stops (on select models) allow water shut-off for maintenance on faucet, such as removal and replacing Eterna cartridges
- Internal spring checks prevent crossflow and back flow of water

B-0669-POL Service Sink Faucet

- Wall mount service sink faucet
- Polished chrome plated finish
- 1/2" NPT female flanged adjustable arm inlets with screwdriver stops (00XX)
- Adjustable centers from 2-1/4" (57 mm) to 8-1/4" (210 mm)
- Eterna cartridges with spring checks
- Lever handles with color coded indexes
- Atmospheric vacuum breaker spout with 3/4" garden hose male thread
- 5-1/2" (140 mm) from back of inlets to center of outlet



MODEL	1/4-Turn CARTRIDGE w/Cross Flow Prevention	OUTLET	CLEARANCE WALL-FAUCET	WALL TO OUTLET	HANDLE	INLET FLANGES	FINISH	NOTES
B-0669-POL	Eterna	3/4" Garden hose male	3-1/16"	5-9/16"	Lever	1/2" NPT female flanged adj. arm inlets screwdriver stops (00XX)	Polished chrome	1/2" NPT atmospheric vacuum breaker (B-0969)
B-0669-01	Eterna	3/4" Garden hose male	3-1/16"	5-9/16"	Lever	1/2" NPT female flanged adj. arm inlets screwdriver stops (00XX)	Polished chrome	1/2" NPT atmospheric vacuum breaker (B-0969); spout w/ pail hook
B-0669-RGH	Eterna	3/4" Garden hose male	3-1/16"	5-9/16"	Lever	1/2" NPT female flanged adj. arm inlets screwdriver stops (00XX-RGH)	Rough chrome	1/2" NPT atmospheric vacuum breaker (B-0969)
B-0670-POL	Eterna	3/4" Garden hose male	3-1/16"	5-9/16"	Lever	1/2" NPT female flanged adj. arm inlets (00GG)	Polished chrome	1/2" NPT atmospheric vacuum breaker (B-0969); no stops
B-0670-01	Eterna	3/4" Garden hose male	3-1/16"	5-9/16"	Lever	1/2" NPT female flanged adj. arm inlets (00GG-RGH)	Polished chrome	1/2" NPT atmospheric vacuum breaker (B-0969); spout w/ pail hook
B-0670-RGH	Eterna	3/4" Garden hose male	3-1/16"	5-9/16"	Lever	1/2" NPT female flanged adj. arm inlets (00GG-RGH)	Rough chrome	1/2" NPT atmospheric vacuum breaker (B-0969)

B-0671-POL Service Sink Outlet

- Polished chrome plated finish
- Nozzle has 3/4" garden hose male thread and pail hook
- Upper wall support with mounting screws
- 6-1/8" (156 mm) from back of inlet to center of outlet
- 2" diameter flange with 1/2" NPT female inlet

B-0671-RGH Same as B-0671-POL except with rough chrome plated finish



B-0672-POL Service Sink Faucet

- 8" wall mount service sink faucet
- Polished chrome plated finish
- Eterna cartridges with spring checks
- Lever handles with color coded indexes
- Plain end spout with pail hook
- 4-5/8" (118 mm) from wall to center of outlet
- 1/2" NPT female eccentric flanged adjustable inlets (00AA)
- Centers adjustable from 7-3/4" (197 mm) to 8-1/4" (210 mm)



B-0672-RGH Same as B-0672-POL except with rough chrome plated finish
B-0673-POL Same as B-0672-POL except with 3/4" garden hose male thread on nozzle
B-0673-RGH Same as B-0672-RGH except with 3/4" garden hose male thread on nozzle

B-0692 Service Sink Outlet

- Concealed loose key straight valve with key and 1/2" NPT female inlet and outlet (B-1027)
- Nozzle with 1/2" NPT inlet and 3/4" garden hose male thread outlet
- 3-13/16" (97 mm) clearance from wall to outlet
- Elevated atmospheric vacuum breaker with 1/2" NPT female connections (B-0929-A)





Service Sink Faucets

- Built-in screwdriver stops (on select models) allow water shut-off for maintenance on faucet, such as removal and replacing Eterna cartridges
- Internal spring checks prevent crossflow and back flow of water

B-0674-BSTP Service Sink Faucet

- 8" wall mount service sink faucet
- Polished chrome plated finish
- Eterna cartridges with spring checks
- Lever handles with color coded indexes
- Vacuum breaker spout and pail hook with 3/4" garden hose male thread
- 5-1/16" (129 mm) from wall to center of outlet
- 1/2" NPT female eccentric flanged inlets (00AA)
- Adjustable centers from 7-3/4" (197 mm) to 8-1/4" (210 mm)
- Built-in stops in faucet body



MODEL	1/4-Turn CARTRIDGE w/Cross Flow Prevention	OUTLET	CLEARANCE WALL-FAUCET	WALL TO OUTLET	HANDLE	INLET FLANGES	FINISH	NOTES
B-0674-BSTP	Eterna	3/4" Garden hose male	2-11/16"	5-1/16"	Lever	1/2" NPT female eccentric (00AA)	Polished chrome	1/2" NPT atmospheric vac. breaker (B-0969); built-in stops in body
B-0674-BSTPM	Eterna	3/4" Garden hose male	2-11/16"	5-1/16"	Lever	1/2" NPT female eccentric (00AA)	Polished chrome	B-0674-BSTP Master carton of 6
B-0674-BSTR	Eterna	3/4" Garden hose male	2-11/16"	5-1/16"	Lever	1/2" NPT female eccentric (00AA)	Rough chrome	1/2" NPT atmospheric vac. breaker (B-0969); built-in stops in body
B-0674-BSTRM	Eterna	3/4" Garden hose male	2-11/16"	5-1/16"	Lever	1/2" NPT female eccentric (00AA)	Rough chrome	B-0674-BSTR Master carton of 6
B-0674-CR-BSTP	Cerama	3/4" Garden hose male	2-11/16"	5-1/16"	Lever	1/2" NPT female eccentric (00AA)	Polished chrome	1/2" NPT atmospheric vac. breaker (B-0969); built-in stops in body
B-0674-CR-BSTR	Cerama	3/4" Garden hose male	2-11/16"	5-1/16"	Lever	1/2" NPT female eccentric (00AA)	Rough chrome	1/2" NPT atmospheric vac. breaker (B-0969); built-in stops in body
B-0674-CR-POL	Cerama	3/4" Garden hose male	2-3/8"	4-3/4"	Lever	1/2" NPT female eccentric (00AA)	Polished chrome	1/2" NPT atmospheric vac. breaker (B-0969)
B-0674-POL	Eterna	3/4" Garden hose male	2-3/8"	4-3/4"	Lever	1/2" NPT female eccentric (00AA)	Polished chrome	1/2" NPT atmospheric vac. breaker (B-0969)
B-0674-POLM	Eterna	3/4" Garden hose male	2-3/8"	4-3/4"	Lever	1/2" NPT female eccentric (00AA)	Polished chrome	B-0674-POL Master carton of 6
B-0674-RGH	Eterna	3/4" Garden hose male	2-3/8"	4-3/4"	Lever	1/2" NPT female eccentric (00AA)	Rough chrome	1/2" NPT atmospheric vac. breaker (B-0969)
B-0674-RGHM	Eterna	3/4" Garden hose male	2-3/8"	4-3/4"	Lever	1/2" NPT female eccentric (00AA)	Rough chrome	B-0674-RGH Master carton of 6
B-0674-RGHM24	Eterna	3/4" Garden hose male	2-3/8"	4-3/4"	Lever	1/2" NPT female eccentric (00AA)	Rough chrome	B-0674-RGH Master carton of 24
B-0693-POL	Eterna	3/4" Garden hose male	3-3/8"	5-3/4"	Lever	1/2" NPT female w/ integral stops (00JJ)	Polished chrome	1/2" NPT atmospheric vac. breaker (B-0969) less pail hook
B-0659	Eterna	3/4" Garden hose male	2-3/8"	4-13/16"	6" Wrist action	1/2" NPT female eccentric (00AA)	Polished chrome	1/2" NPT atmospheric vac. breaker (B-0969)
B-2271	Eterna	3/4" Garden hose male w/ QD fitting	2-3/8"	4-3/4"	Lever	1/2" NPT female eccentric (00AA)	Rough chrome	1/2" NPT atmospheric vac. breaker (B-0969); 1/2" NPT supply nipples
B-2271-CR	Cerama	3/4" Garden hose male w/ QD fitting	2-3/8"	4-3/4"	Lever	1/2" NPT female eccentric (00AA)	Rough chrome	1/2" NPT atmospheric vac. breaker (B-0969); 1/2" NPT supply nipples (B-0425-M)
B-2271-POL	Eterna	3/4" Garden hose male w/ QD fitting	2-3/8"	4-3/4"	Lever	1/2" NPT female eccentric (00AA)	Polished chrome	1/2" NPT atmospheric vac. breaker (B-0969); 1/2" NPT supply nipples (B-0425-M)
B-2271-POL-CR	Cerama	3/4" Garden hose male w/ QD fitting	2-3/8"	4-3/4"	Lever	1/2" NPT female eccentric (00AA)	Polished chrome	1/2" NPT atmospheric vac. breaker (B-0969); 1/2" NPT supply nipples (B-0425-M)



Service Sink and Sill Faucets

- Built-in screwdriver stops (on select models) allow water shut-off for maintenance on faucet, such as removal and replacing Eterna cartridges
- Internal spring checks prevent crossflow and back flow of water

B-0695-ST Service Sink Fitting

- 8" concealed bypass mixing valve with 1/2" NPT female outlet
- Braced chrome plated spout with 1/2" NPT female wall flange, 3/4" garden hose male thread and pail hook
- Rough-in 2-1/4" (57 mm) minimum to 3-1/2" (89 mm) maximum center of inlets to finished wall face
- Elevated atmospheric vacuum breaker with 1/2" NPT female connections (B-0929-A)
- Loose key valves behind teardrop escutcheons with 1/2" NPT female inlets
- Four arm handles with color coded indexes



B-0695 Same as B-0695-ST except with 1/2" NPT female union joint inlets and without integral stops

B-0697 Service Sink Fitting

- 8" concealed bypass mixing valve with 1/2" NPT female outlet
- Braced chrome plated spout with 1/2" NPT female wall flange, 3/4" garden hose male thread and pail hook
- Rough-in 2-1/4" (57 mm) minimum to 3-1/2" (89 mm) maximum center of inlets to finished wall face
- Four arm handles with color coded indexes
- 1/2" NPT female union joint inlets

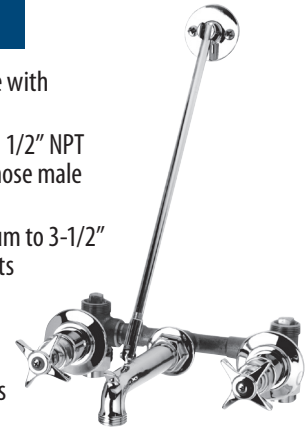

B-0698 Same as B-0697 except with solder type union inlets for 5/8" (16 mm) O.D. copper tubing

B-0699 Same as B-0697 except with vacuum breaker spout

B-0699-ST Same as B-0699 except with integral stops with 1/2" NPT female inlets and teardrop escutcheons

B-2480 Service Sink Faucet

- 8" wall mount faucet with rough chrome plated finish
- 4-5/8" (118 mm) from wall to center of outlet
- Rough chrome plated spout with 3/4" garden hose male outlet and pail hook
- Four arm handles with color coded indexes
- 1/2" NPT female eccentric flanged inlets (00AA)
- Adjustable centers from 7-3/4" (197 mm) to 8-1/4" (210 mm)
- Eterna cartridges with spring checks



Accessories

B-0618-01 Reinforced PVC Hose

- Reinforced PVC hose
- 30" (762 mm) long
- 3/4" garden hose inlet with washer
- Plain outlet



B-0618-02 Same as B-0618-01 except with 4' (1.2 m) hose

B-0618-03 Same as B-0618-01 except with 5' (1.5 m) hose

B-0653 Mop Hanger



- Stainless steel mop hanger
- Three spring-loaded rubber grips
- 17-11/16" (449 mm) long x 2-3/4" (70 mm) wide
- Includes mounting screws

B-0654 Stainless Steel Single Mop Hanger

- Stainless steel single mop hanger
- Spring-loaded rubber grip
- 30" (762 mm) rubber hose (B-0618-01) with 3/4" garden hose inlet
- Includes mounting screws



Sill and Heavy Duty Sink Faucets

B-0700 Single Sink Faucet



- Wall mount single sill faucet
- 1/2" NPT female inlet
- 2" (51 mm) dia. flange
- 3-5/8" (92 mm) from wall to center of plain end outlet
- Four-arm handle with blue index
- Eterna cartridge

B-0700-LT-CR-K Same as B-0700 except with B-LT outlet, Cerama cartridge and inlet installation kit

B-0700-LTCR177F Same as B-0700 except with B-LT outlet, Cerama cartridge and lever handle

B-0700-01 Same as B-0700 except with push button metering cartridge with adjustable flow

B-0700-124A Same as B-0700 except with loose key spindle assembly and T-handle with screw

B-0702 Same as B-0700 except with 3/4" garden hose outlet

B-0702-CR Same as B-0702 except with Cerama cartridge (Quarter-turn)

B-0702-WH4 Same as B-0702 except with wrist action handle (B-WH4) with blue index

B-0703 Single Sink Faucet



- Wall mount single sill faucet
- 1/2" NPT male inlet
- 3-1/4" (83 mm) wall to center of plain end outlet
- Four-arm handle with blue index
- Eterna cartridge

B-0703-124A Same as B-0703 except with loose key stop and T-handle with screw

B-0704 Same as B-0703 except with 3/4" garden hose male outlet

B-0706 Self-Closing Single Sink Faucet

- Wall mount single sill faucet
- 1/2" NPT female inlet
- 2" (51 mm) dia. flange
- 3-5/8" (92 mm) wall to center of plain end outlet
- Four-arm handle with blue index
- Fast self-closing valve



B-0707 Same as B-0706 except with 3/4" garden hose male outlet

B-0708 Self-Closing Single Sink Faucet



- Wall mount single sill faucet
- 1/2" NPT male inlet
- 3-1/4" (83 mm) wall to center of plain end outlet
- Four-arm handle with blue index
- Fast self-closing valve

B-0708-JJ Same as B-0708 except with 1/2" NPT female inlet, loose key stop, with extension

B-0709 Same as B-0708 except with 3/4" garden hose male outlet

B-0709-JJ Same as B-0709 except with 1/2" NPT female inlet, loose key stop, with extension

B-0710 Single Basin Faucet



- Single hole single temperature deck mount basin faucet
- 1/2" NPSM male inlet
- 4-1/8" (105 mm) from center of faucet to center of outlet
- Four-arm handle with blue index
- 2.2 GPM aerator (B-0199-02)
- Eterna cartridge
- Includes tailpiece and nut for 1/4" NPT connection (150A)

B-0710-F12 Same as B-710 except with B-0199-02-F12 aerator (1.2 GPM)

B-0710-LT-CR Same as B-710 except with B-LT stream regulator outlet and Quarter-turn Cerama cartridge

B-0710-HW Same as B-710 except with red (hot) index

B-0710-WS Same as B-0710 except with 1.5 GPM aerator (B-0199-02-WS)

B-0711 Same as B-0710 except with fast self-closing valve, four arm handle and blue index

B-0712-WA Same as B-0710 except with 4" wrist-action handle and wrist-action metering cartridge (at right, and p. D30)

B-0719 Same as B-0710 except with lever handle with blue index

B-0719-CR-VRS Same as B-0719 except with Quarter-turn Cerama cartridge with check valve and vandal-resistant handle screw

B-0712-WA



Looking for Nozzles, Aerators, Goosenecks and Handles?
See Our **NEW** Accessories section in the G-12

Sill and Heavy Duty Sink Faucets

B-0715 Single Sink Faucet



- Wall mount single sill faucet
- 1/2" NPT male inlet
- 2" (51 mm) dia. adjustable wall flange
- 4-3/4" (121 mm) inlet to center of outlet
- Lever handle with blue index
- Plain end outlet
- Eterna cartridge



B-0715-LT-CR Same as B-0715 except with Cerama cartridge and stream regulator outlet (B-LT)
B-0716 Same as B-0715 except with four arm handle

B-0717 Single Sink Faucet



- Wall mount single sill faucet
- 1/2" NPT male inlet
- 2" (51 mm) dia. adjustable wall flange
- 4-3/4" (121 mm) from inlet to center of outlet
- Lever handle with blue index
- 3/4" garden hose male outlet
- Eterna cartridge



B-0718 Same as B-0717 except with four arm handle

B-0720 Sill Faucet with Vacuum Breaker

- Single hole single temperature wall mount sill faucet
- 2" (51 mm) dia. flange
- 1/2" NPT female inlet
- Loose key stop with cap
- Atmospheric vacuum breaker (B-0969)
- 3/4" garden hose male outlet
- Polished chrome plated finish
- Includes T-handle and screw



B-0720-RGH Same as B-0720 except with rough chrome plated finish
B-2301 Same as B-0720 except with four arm handle

B-0722 Single Hole Single Temp Sill Faucet

- Single hole single temperature wall mount sill faucet with polished chrome finish
- Quarter-turn Eterna Cartridge with loose key stop
- Vacuum breaker spout with 3/4" garden hose male outlet
- 3/4" NPT female inlet
- 2" (51 mm) dia. flange
- 4-15/16" (127 mm) wall to center of outlet



B-0730 Sill Faucet

- Single hole single temperature wall mount sill faucet
- 1/2" NPT female inlet
- 2" (51 mm) dia. flange
- Loose key stop with cap
- 3/4" garden hose male outlet
- Rough chrome plated finish
- Includes T-handle and screw



B-0730-POL Same as B-0730 except with polished chrome plated finish
B-0731-POL Same as B-0730-POL except with 3/4" NPT female inlet

B-0736-POL Sill Faucet with Vacuum Breaker

- Single hole single temperature wall mount sill faucet
- 1/2" NPT female inlet
- 2" (51 mm) dia. flange
- Loose key stop with cap
- Removable vacuum breaker with 3/4" garden hose male outlet (B-0972)
- Polished chrome plated finish
- Includes T-handle and screw



B-0736 Same as B-0736-POL except with rough chrome finish
B-0737 Same as B-0736-POL except with 3/4" female inlet and rough chrome finish
B-0737-POL Same as B-0736-POL except with 3/4" female inlet

B-2460 Single Basin Faucet



- Single hole single temperature deck mount basin faucet
- 1/2" NPSM male inlet
- 4-1/8" (105 mm) from center of faucet to center of spout
- 4" decorative wrist-action handle with blank index
- Cerama cartridge
- Chrome plated deck plate
- 2.2 GPM vandal-resistant aerator (B-0199-07)
- Includes (150A) tailpiece and nut for 1/4" NPT connection



Bedpan Washers

B-0675 Bedpan Washer

- Wall mount pedal valve (B-0504-01) with angle loose key stops with 1/2" NPT female inlets (B-1350)
- Angle loose key volume control with 3/8" NPT female outlet (B-1355)
- Elevated atmospheric vacuum breaker with 3/8" NPT flanged female connections (B-0929)
- Wall hook outlet with 3/8" NPT flanged female inlet (B-0104)
- 68" (1727 mm) PVC hose (B-0068-R) with extended spray wand self-closing valve (002865-40)



B-0676 Same as B-0675 except with extended spray wand connected directly to hose – self-closing valve is omitted
B-0676-54V Same as B-0676 except with 54" (1372 mm) vinyl hose

B-0678 Bedpan Washer

- 1/2" NPT female angle loose key stop with control valve and vacuum breaker (B-0968) outlet
- 68" (1727 mm) PVC hose (B-0068-R) with extended spray wand self-closing valve (002865-40)



B-0679 Same as B-0678 except with extended spray wand connected directly to hose – self-closing valve is omitted

B-0685 Bedpan Washer

- Single wall-mount pedal valve (B-0508-01) with 1/2" NPT female inlet with angle stops (B-1350)
- Angle volume control valve (B-1355) with 3/8" NPT female outlet on pedal valve
- Elevated atmospheric vacuum breaker (B-0929) with 3/8" NPT connections
- Wall hook outlet with 3/8" NPT female flanged inlet (B-0104)
- 68" (1727 mm) PVC hose (B-0068-R) with extended spray wand self-closing valve (002865-40)



B-0686 Same as B-0685 except with extended spray wand connected directly to hose – self closing valve is omitted

B-0677 Bedpan Washer

- Wall mount pedal valve (B-0504-01) with angle loose key stops with 1/2" NPT female inlets (B-1350)
- Angle loose key volume control with 3/8" NPT female outlet (B-1355)
- Vacuum breaker unit has 3/8" NPT female flanged inlet
- 68" (1727 mm) PVC hose (B-0068-R) with extended spray wand outlet (002861-40)

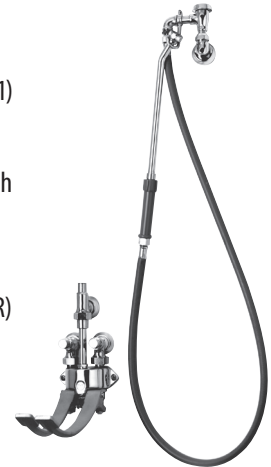

B-0680-ST Bedpan Washer

- 8" concealed bypass mixing valve (B-1035-ST)
- Straight loose key stops with 1/2" NPT female inlets
- Elevated atmospheric vacuum breaker (B-0929-A) with 1/2" NPT female connections
- Wall hook outlet with 3/8" NPT female flanged inlet (B-0104)
- 68" (1727 mm) PVC hose (B-0068-R) with self-closing spray valve (002865-40)



B-0682-ST Bedpan Washer

- 8" concealed bypass mixing valve (B-1035-ST)
- Straight loose key stops with 1/2" NPT female inlets
- Vacuum breaker outlet
- 68" (1727 mm) PVC hose (B-0068-R) with extended spray wand self-closing valve (002865-40)
- Dummy wall hook (B-0104-D)



B-0682 Same as B-0682-ST except without loose key stops

Bedpan Washers, Wall Hook Outlets and Dummy Wall Hooks

B-0687 Bedpan Washer

- Single wall mount pedal valve (B-0508-01) with 1/2" NPT female inlet with angle stops (B-1350)
- Angle volume control valve (B-1355) with 3/8" NPT female outlet on pedal valve
- Vacuum breaker has 3/8" NPT female flanged inlet and outlet (B-0968)
- 68" (1727 mm) PVC hose (B-0068-R) with extended spray wand self-closing valve (002861-40)



B-0104 Wall Hook Outlet

- 3/8" NPT flanged female inlet
- 3/4 - 14 male outlet connects to hoses



B-0104-D Dummy Wall Hook

- Attaches to wall with screws provided
- Flange diameter 2" (51 mm)



Bedpan Washers, Hoses and Sprays

B-0690 Bedpan Washer with Self-Closing Spray Valve

- 1/2" NPT male inlet adapter (055A)
- 68" (1727 mm) reinforced PVC hose (B-0068-R)
- Extended spray wand self-closing valve (002865-40)



B-0691 Bedpan Washer with Extended Spray Outlet

- 1/2" NPT male inlet adapter (055A)
- 68" (1727 mm) reinforced PVC hose (B-0068-R)
- Extended spray wand outlet (002861-40)



B-0950 Bedpan Washer with Self-Closing Valve

- 1/2" NPT male inlet adapter (055A)
- 44" (1118 mm) flexible stainless steel hose (B-0044-H)
- 1.15 GPM angle spray valve (B-0107-035)



B-0950-01 Same as B-0950 except with 68" (1727 mm) flexible stainless steel hose (B-0068-H)

B-0950-54H Same as B-0950 except with 54" (1372 mm) flexible stainless steel hose (B-0054-H)

B-0950-VB Same as B-0950 except with continuous pressure vacuum breaker (B-0970-FE)

B-0956 Same as B-0950 except with 44" (1118 mm) reinforced PVC hose

B-0955 Bedpan Washer with Self-Closing Valve

- 1/2" NPT male inlet adapter (055A)
- 44" (1117 mm) reinforced PVC hose (B-0044-R)
- 1.15 GPM spray valve outlet (B-0107)



B-0957 Same as B-0955 except with 44" (1118 mm) braided vinyl hose

B-0974 Bedpan Washer with Self-Closing Valve

- 1/2" NPT male inlet adapter (055A)
- 56" (1422 mm) flexible stainless steel hose (B-0056-H)
- Angled spray valve with adjustable spray head



B-0973 Bedpan Washer with Self-Closing Valve

- 1/2" NPT male inlet adapter (055A)
- 48" (1219 mm) flexible stainless steel hose (B-0048-H)
- Angled push button spray valve with adjustable spray head



Concealed Single Valves

B-1020 Concealed Bypass Valve



- 1/2" NPT female union inlet on bottom
- 1/2" NPT female inlet on top
- 1/2" NPT female outlet
- Four arm handle with blue index
- Adjustable wall flange
- Eterna cartridge

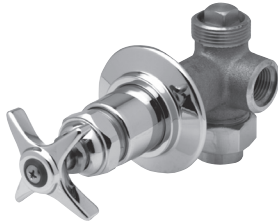

B-1025 Concealed Straight Valve



- 1/2" NPT female inlet and outlet
- Four arm handle with blue index
- Adjustable wall flange
- Eterna cartridge

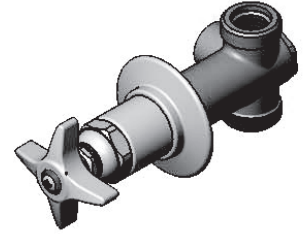

B-1025-1 Same as B-1025 except with "Hot" handle

B-1025-ST Concealed Straight Valve



- 1/2" NPT outlet
- Straight loose key stop with 1/2" NPT female inlet
- Adjustable tear drop escutcheon
- Four-arm handle with blue index
- Eterna cartridge
- Includes T-handle and screw



B-1027-UCP Concealed Straight Loose Key Stop

- 1/2" NPT female union inlet
- 1/2" NPT female outlet
- Adjustable wall flange
- Includes T-handle and screw
- Loose key spindle assembly (124A)



B-1027 Same as B-1027-UCP except without a union coupling nut

B-1028 Same as B-1027 except with built-in check valve feature (right)



B-1029 Concealed Straight Valve



- Slow self-closing metering cartridge with adjustable timed flow
- Blank push button cap with vandal-resistant screw
- Adjustable wall flange
- 1/2" NPT female inlet and outlet



B-1029-1 Same as B-1029 except indexed "Cold"

B-1029-2 Same as B-1029 except indexed "Hot"

B-1029-PA Concealed Straight Valve



- Pivot action metering cartridge with blank handle and vandal-resistant screw
- 1/2" NPT female inlet and outlet
- Adjustable wall flange



Vacuum Breaker Assemblies

B-0457 Vacuum Breaker Assembly

- 8" (203 mm) C/C mounting vacuum breaker unit
- 3/4" NPT male connections
- Angled adjustable height slip flanges
- Pipes must be held rigid under sink with connection fitting, brace, etc.

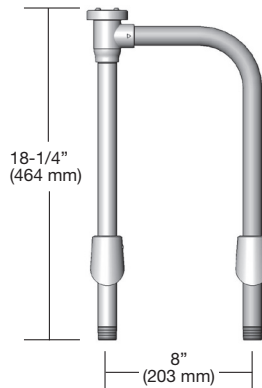

B-0458 Vacuum Breaker Assembly

- 8" (203 mm) C/C mounting vacuum breaker unit
- 3/4" NPT male connections
- Adjustable 2" (51 mm) diameter flanges
- Pipes must be held rigid under sink with connection fitting, brace, etc.

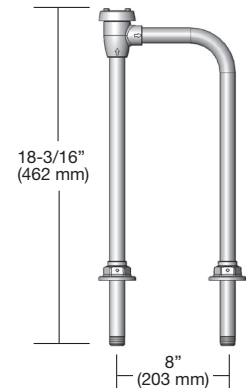

Lab Hose Cocks and Turrets

BL-4000-01 Hose Cock



- Ball valve construction
- CSA approved for natural gas up to .5 psi max.
- 125 psi max. for other gases
- 3/8" NPT male inlet
- Serrated hose tip
- Snap-in color indexes included; gas, air or vacuum
- Length 3-7/8" (98 mm); height 1-7/8" (48 mm)



BL-4000-01M Master Box (12)

Note: Not for water, steam or oxygen

BL-4005-01 Hose Cock



- Ball valve construction
- Integral check valve inlet
- CSA approved for natural gas up to .5 psi max.
- 125 psi max. for other gases
- 3/8" NPT male inlet
- Serrated hose tip
- Snap-in color indexes included; gas or air
- Length 3-7/8" (98 mm); height 1-1/2" (37 mm)

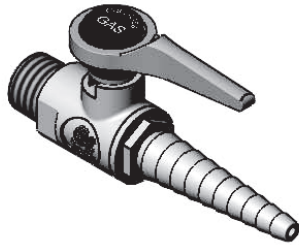

Note: Not for water, steam or oxygen

BL-4010-01 Needle Valve

- 3/8" NPT male inlet
- Floating stainless steel needle point
- Serrated hose tip
- .5 psi max. for natural gas
- For use with oxygen and other special gases (80 psi max.)
- Snap-in color indexes included; gas, air or vacuum
- Length 3-13/16" (97 mm); height 2-3/4" (70 mm)



Note: Not for water or steam

BL-4100-0 Laboratory Turret

- Two 3/8" NPT female outlets at 90°
- 3/8" NPT female inlet
- Black plastic mounting gasket included
- 2" (51 mm) diameter; height 3" (76 mm)
- 2-3/16" (55 mm) height to center of outlet



- BL-4100-01 One outlet
- BL-4100-02 Two outlets at 180°
- BL-4100-03 Three outlets at 90°
- BL-4100-04 Four outlets at 90°
- BL-4100-05 Top outlet only

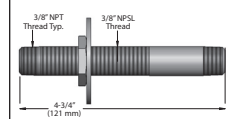

Note: BL-5500-10
3/8" supply nipple with locknut and washer (order separately)

BL-4102-0 Vandal Resistant Lab Turret

- 1/4" diameter anti-rotation pin
- Black plastic mounting gasket included
- 2" (51 mm) diameter; height 3" (76 mm)
- 2-3/16" (55 mm) height to center of outlet
- 3/8" NPT female inlet
- Two 3/8" NPT female side outlets at 90°



- BL-4102-01 One outlet
- BL-4102-02 Two outlets at 180°

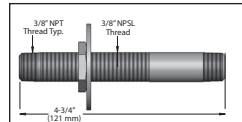

Note: BL-5500-10
3/8" supply nipple with locknut and washer (order separately)

Lab Hose Cocks and Turrets

BL-4200-01 Turret with One Hose Cock



- 3/8" NPT female inlet
- Snap-in color indexes included; gas, air or vacuum
- Diameter 2" (51 mm); height 3-5/8" (92 mm)
- One (1) BL-4000-01 ball valve hose cock
- .5 psi max. for natural gas
- 125 psi max. for other gases

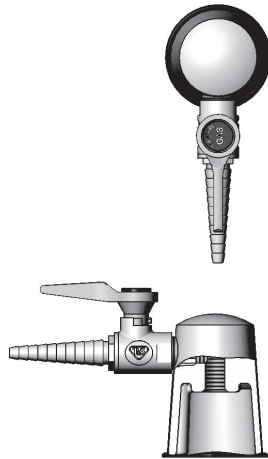

- BL-4200-0 Turret with two hose cocks at 90°
- BL-4200-02 Turret with two hose cocks at 180°
- BL-4200-03 Turret with three hose cocks
- BL-4200-04 Turret with four hose cocks

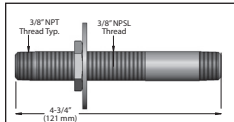

Note: BL-5500-10
3/8" supply nipple with locknut and washer (order separately)

BL-4203-01 Vandal Resistant Turret with Hose Cock



- 1/4" diameter anti-rotation pin
- 3/8" NPT female bottom inlet
- BL-4000-01 ball valve hose cock
- 2" (51 mm) diameter; 3-5/8" (92 mm) height
- 2-3/16" (55 mm) height to center of outlet
- Snap-in color coded indexes included: gas, air or vacuum
- .5 psi max. for natural gas
- 125 psi max for other gases



- BL-4203-0 Turret with two hose cocks at 90°
- BL-4203-02 Turret with two hose cocks at 180°
- BL-4203-04 Turret with four hose cocks at 90°

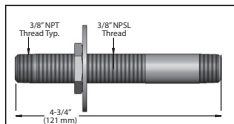

Note: BL-5500-10
3/8" supply nipple with locknut and washer (order separately)

BL-4210-0 Turret with Needle Valves

- 3/8" NPT female bottom inlet
- Two BL-4010-01 needle valve hose cocks at 90°
- 2" (51 mm) diameter; 4-7/8" (124 mm) height
- 2-3/16" (56 mm) height to center of outlet
- Valve has floating stainless steel needle point
- For use with oxygen, hydrogen or other special gases up to 80 psi

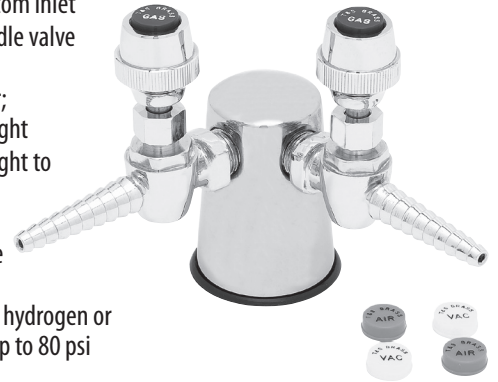

- BL-4210-01 Turret with one needle hose cock
- BL-4210-02 Turret with two needle hose cocks at 180°
- BL-4210-04 Turret with four needle hose cocks at 90°

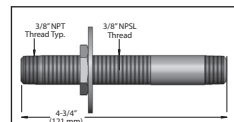

Note: BL-5500-10
3/8" supply nipple with locknut and washer (order separately)

BL-4250-01 Panel Flange with Hose Cock



- 3/8" NPT female inlet
- BL-4000-01 ball valve hose cock
- Serrated hose tip
- 4-1/2" (114 mm) length
- 2" dia. (51 mm) wall flange
- Snap-in color coded indexes included: gas, air or vacuum
- .5 psi max. for natural gas
- 125 psi max for other gases

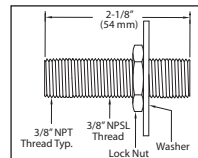

Note: BL-5500-07
3/8" supply nipple with locknut and washer (order separately)

Panel Flanges, Hose Cocks and Turrets

BL-4250-02 Double Panel Flange with Two Hose Cocks



- 3/8" NPT female inlet
- Two BL-4010-0 ball valve hose cocks with serrated hose tips at 90°
- 3-7/8" (98 mm) from wall
- 1-3/4" (44 mm) flange diameter
- 6-1/16" (154 mm) width
- Snap-in color coded indexes included: gas, air or vacuum
- .5 psi max. for natural gas
- 125 psi max for other gases

Inset: BL-4250-05
Double panel flange
with 3/8" NPT inlet
and dual outlets

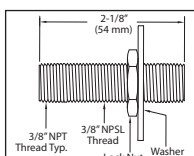
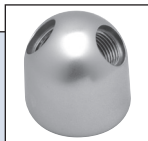

Note: BL-5500-07
3/8" supply nipple
with locknut and
washer (order
separately)

BL-4250-07 Flanged Elbow

- 3/8" NPT female inlet and outlet
- 2" dia. (51 mm) flange
- 2-1/4" (57 mm) from flange surface to center of outlet
- Can be mounted vertically or horizontally



BL-4250-08 Wye Fitting

- 3/8" NPT male inlet
- Two 3/8" NPT female outlets at 70°

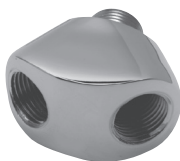

BL-4260-01 Panel Flanges with Needle Valve

- 3/8" NPT female inlet
- BL-4010-01 needle valve hose cock with serrated hose tip
- 4-7/16" (113 mm) length from wall to tip
- 2" dia. (51 mm) flange
- Snap-in color coded indexes included: gas, air or vacuum



Panel Flanges:

BL-4250-03
3/8" NPT female inlet
and outlet

BL-4250-06 1/2" NPT
female inlet, 3/8" NPT
female outlet

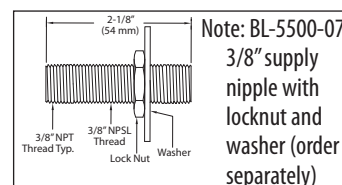
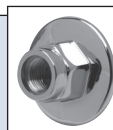

Note: BL-5500-07
3/8" supply
nipple with
locknut and
washer (order
separately)

BL-4300-0 Turret with Two Straight Stops

- Turret with two straight stops (BL-4500-1) at 90°
- 3/8" NPT female inlet
- Serrated hose tips
- 5-7/16" (138 mm) from center of inlet to end of tip
- 5-11/16" (144 mm) height
- 2" (51 mm) diameter turret
- Snap-in color coded indexes included: gas, air or vacuum

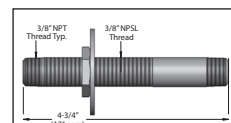

Note: BL-5500-10
3/8" supply nipple
with
locknut and
washer
(order separately)

BL-4300-01 Turret with one
straight stop

BL-4300-02 Turret with two
straight stops at 180°

BL-4422-0 Turret with Two Water Outlets

- 2" (51 mm) dia. turret base
- Double water outlet at 90° with angle serrated hose tips
- Atmospheric vacuum breakers
- 3/8" NPT female inlet



BL-4422-01 Turret with single
water outlet

Panel Flanges, Stops and Turrets

BL-4350-01 Panel Flange with Straight Stop

- 3/8" NPT female inlet
- Serrated hose tip
- 5-11/16" (144 mm) length
- 2" (51 mm) diameter flange
- Snap-in color coded indexes included: gas, air or vacuum
- Internal floating stainless steel cone regulates gas flow as handle is turned
- .5 psi max. for natural gas
- 125 psi max. for other gases

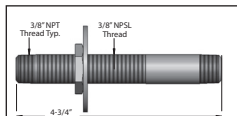
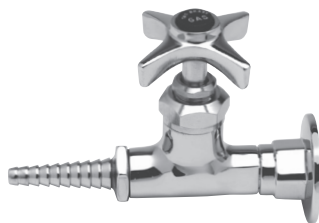

Note: BL-5500-10
3/8" supply nipple with
locknut and washer
(order separately)

BL-4355-01 Same as
BL-4350-01 except with
green cold water index

BL-4500-01 Straight Stops

- 3/8" NPT male inlet
- 5-3/16" (132 mm) length
- Serrated hose tip
- Snap-in color coded indexes included: gas, air or vacuum
- Internal floating stainless steel cone regulates gas flow as handle is turned
- .5 psi max. for natural gas
- 125 psi max. for other gases



BL-4500-02 Same as BL-4500-01 except with Eterna construction for water with green cold water index

BL-4501-01 Straight Stop

- Grease-free straight stop for special gases
- 3/8" NPT male inlet
- Internal floating stainless steel cone regulates gas flow as handle is turned
- Serrated hose tip
- 125 psi max.



BL-4520-01 Angle Stop

- Serrated hose tip
- Snap-in color coded indexes included: gas, air or vacuum
- Internal floating stainless steel cone regulates gas flow as handle is turned
- 3-3/8" (86 mm) length from center
- 4-13/16" (122 mm) height



BL-4520-02 Same as BL-4520-01 except Eterna construction for water with green cold water index

Remote Control Valve Units

BL-4700-01
Remote Control Straight Valve Unit

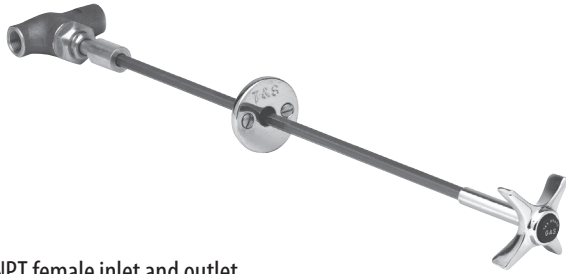

- 3/8" NPT female inlet and outlet
- Stainless steel floating cone and removable seat
- Snap-in color coded indexes included: gas, air or vacuum
- 18" (457 mm) distance from center of valve to face of panel is field adjustable for shorter distances
- 2" dia. (51 mm) polished chrome panel flange with mounting screws

BL-4700-02 Same as BL-4700-01 except with Eterna construction for water with green cold water index

BL-4720-01
Remote Control Angle Valve Unit



- 3/8" NPT female inlet and outlet
- Outlet at 90° to inlet
- Stainless steel floating cone and removable seat
- Snap-in color coded indexes included: gas, air or vacuum
- 18" (457 mm) distance from center of valve to face of panel is field adjustable for shorter distances
- 2" dia. (51 mm) polished chrome panel flange with mounting screws

BL-4720-01MF Same as BL-4720-01 except with guide bushing for metal furniture
BL-4720-02MF Same as BL-4720-02 except with guide bushing for metal furniture
BL-4720-03 Same as BL-4720-01 except with black heat resistant handle for steam

BL-4720-02 Same as BL-4720-01 except with Eterna construction for water with green cold water index

BL-4710-01
Remote Control Straight Valve Unit



- Universal joint at valve to correct for minor misalignment
- 3/8" NPT female inlet and outlet
- Stainless steel floating cone and removable seat
- Snap-in color coded indexes included: gas, air or vacuum
- 19-9/16" (497 mm) distance from center of valve to face of panel is field adjustable for shorter distances
- 2" dia. (51 mm) polished chrome panel flange with mounting screws

BL-4710-02 Same as BL-4710-01 except with Eterna construction for water with green cold water index

BL-4710-03 Same as BL-4710-01 except with black heat resistant handle for steam

BL-4730-03
Remote Control Angle Valve Unit



- Universal joint at valve to correct for minor misalignment
- 3/8" NPT female inlet and outlet
- Outlet at 90° to inlet
- Stainless steel floating cone and seat for steam
- Black heat-resistant handle
- 19-9/16" (497 mm) distance from center of valve to face of panel is field adjustable for shorter distances
- 2" dia. (51 mm) polished chrome panel flange with mounting screws

Fume Hood Fittings

BL-4705-01
Front Mounted Fume Hood Valve

- 3/8" NPT female inlet and outlet
- For flat face hood
- Stainless steel cone and removable seat
- Four-arm handle
- Snap-in color coded indexes included: gas, air or vacuum
- Working parts are removable from front eliminating entry into hood compartments



BL-4705-03 Same as BL-4705-01 except with black heat resistant handle for steam

BL-4750-05
Panel Flange with Straight Serrated Tip

- 3/8" NPT female inlet
- 2" (51 mm) diameter flange
- 3-5/8" (92 mm) length



BL-4750-06 Same as BL-4750-05 except with angle serrated tip, 3-1/2" (89 mm) length

Front Guide Fittings for Remote Control Valve Units

BL-4740-03
Angle Guide Bushing

- Polished chrome plated
- For use on wood furniture
- Furnished with two screws
- 2" (51 mm) x 1-7/16" (37 mm)
- 45° angle standard – can be furnished at any angle from 30° to 60° in sufficient quantity
- Mounting holes on 1-9/16" (40 mm) centers

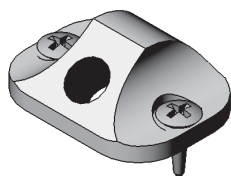

BL-9005-01
Crowned Top Flush Plate

- Convex top surface for use on tabletops without recess
- 1-1/8" (29 mm) diameter thread
- Fits table tops from 3/8" (9 mm) to 1-1/2" (38 mm) thick
- Designed to receive BL-9000-01 upright rods and BL-9000-04 adapters
- Polished chrome plated brass

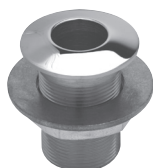

BL-4750-03
Turret with Rigid Gooseneck

- 3/8" NPT female inlet
- For use with remote valves
- Serrated hose tip
- Plastic mounting gasket included
- 2" (51 mm) turret diameter
- 12-11/16" (322 mm) height
- 5-5/8" (143 mm) spread gooseneck



BL-4750-07 Same as BL-4750-03 except with wall mounted turret



Double Ledge Faucets

BL-5700-01 Double Ledge Faucet

- Single hole deck mount laboratory mixing faucet
- 5-5/8" (143 mm) swivel/rigid gooseneck with serrated hose tip
- 18" (457 mm) flexible inlets with 5/8" compression / 1/2" NPSM male couplings
- Quarter-turn Eterna cartridges with spring checks
- Four arm handles with color coded indexes
- 13-11/16" (347 mm) height
- 6-7/8" (175 mm) clearance
- 1-1/8" (25 mm) shank diameter
- Deck gasket included
- (014200-45) lock washer included for rigid applications



BL-5700-04



BL-5700-08 Double Ledge Faucet

- Single hole deck mount laboratory mixing faucet
- 5-11/16" (144 mm) swivel/rigid vacuum breaker nozzle with serrated hose tip
- 18" (457 mm) flexible inlets with 5/8" compression / 1/2" NPSM male couplings
- Quarter-turn Eterna cartridges with spring checks
- Four arm handles with color coded indexes
- 12-3/16" (310 mm) height
- 1-1/8" (29 mm) shank diameter
- 6-1/16" (154 mm) clearance
- Deck gasket included
- (014200-45) lock washer included for rigid applications

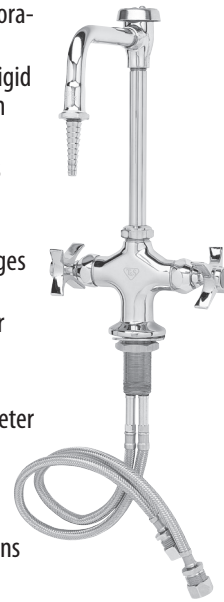

BL-5700-09



BL-5700 Models:

MODEL	1/4-Turn CARTRIDGE w/Cross Flow Prevention	OUTLET	HEIGHT	CLEARANCE	SPREAD	HANDLE	INLET	VR	NOTES
BL-5700-01	Eterna	Swivel/rigid gooseneck with serrated hose tip	13-11/16"	6-13/16"	5-5/8"	Four-Arm Lab	(2) 18" flex. S/S supplies w/ 5/8" compression/ 1/2" NPSM male inlets	N	Single hole deck mount
BL-5700-04	Eterna	5-5/8" Swivel/rigid gooseneck (133X-A22)	13-9/16"	9-1/8"	5-5/8"	Four-Arm Lab	(2) 18" flex. S/S supplies w/ 5/8" compression/ 1/2" NPSM male inlets	N	Single hole deck mount; 2.2 GPM aerator
BL-5700-08	Eterna	Swivel/rigid V.B. nozzle with serrated hose tip (BL-5560-03)	12-3/16"	6-1/16"	5-5/8"	Four-Arm Lab	(2) 18" flex. S/S supplies w/ 5/8" compression/ 1/2" NPSM male inlets	N	Single hole deck mount
BL-5700-08-VR	Eterna	Swivel/rigid V.B. nozzle with serrated hose tip	12-3/16"	6-1/16"	5-5/8"	Lever	(2) 18" flex. S/S supplies w/ 5/8" compression/ 1/2" NPSM male inlets	Y	Single hole deck mount; V.R. handle screws (VRS-2)
BL-5700-09	Eterna	Swivel/rigid V.B. nozzle with serrated hose tip	12-3/8"	6-3/16"	5-5/8"	Four-Arm Lab	(2) 18" flex. S/S supplies w/ 5/8" compression/ 1/2" NPSM male inlets	N	Single hole deck mount

VR Vandal-resistant



Double Ledge Faucets

BL-5704-05 Double Ledge Faucet

- Single hole deck mount laboratory mixing faucet
- 5-13/16" (147 mm) swivel/rigid gooseneck
- 2.2 GPM aerator (B-0199-02)
- 18" (457 mm) flexible inlets with 5/8" compression /1/2" NPSM male couplings
- Quarter-turn Eterna cartridges with spring checks
- 4" wrist-action handles with color coded indexes
- 13-11/16" (348 mm) height
- 8-3/8" (213 mm) clearance
- 1-1/8" (25 mm) shank diameter
- Deck gasket included
- (014200-45) lock washer included for rigid applications

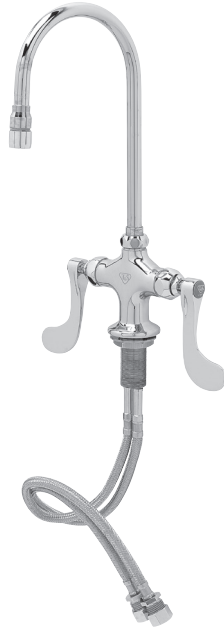

BL-5704-08WH4 Double Ledge Faucet

- Single hole deck mount laboratory mixing faucet
- 5-5/8" (143 mm) swivel/rigid vacuum breaker nozzle with serrated hose tip
- 18" (457 mm) flexible inlets with 5/8" compression /1/2" NPSM male couplings
- Quarter-turn Eterna cartridges
- 4" wrist-action handles with color coded indexes
- 12-3/16" (310 mm) height
- 6" (152 mm) clearance
- 1-1/8" (29 mm) shank diameter
- Deck gasket included
- (014200-45) lock washer included for rigid applications



BL-5708-08WH4-VR Same as BL-5704-01 except with vandal-resistant screws

Single Ledge Lab Faucets

BL-5705-01 Single Ledge Faucet

- Single hole single temperature deck mount laboratory mixing faucet
- 5-7/8" (149 mm) swivel/rigid gooseneck with serrated hose tip
- 1/2" NPSM male inlet
- 7-5/16" (186 mm) clearance
- 14-1/8" (359 mm) height
- Deck gasket included
- Quarter-turn Eterna cartridges with spring checks
- Four arm handle with green cold water index
- Fits counters up to 1-1/2" (28 mm) thick
- Includes tailpiece and nut for 1/4" NPT connection (150A)



BL-5705-04 Same as BL-5705-01 except with 2.2 GPM aerator

BL-5705-08 Single Ledge Faucet

- Single hole single temperature deck mount laboratory faucet
- 5-11/16" (144 mm) swivel/rigid vacuum breaker nozzle with serrated hose tip
- 1/2" NPSM male inlet
- 12-13/16" (325 mm) height
- 6-1/2" (165 mm) clearance
- Deck gasket included
- Quarter-turn Eterna cartridges with spring checks
- Four arm handle with green cold water index
- Fits counters up to 1-1/2" (28 mm) thick
- Includes tailpiece and nut for 1/4" NPT connection (150A)



BL-5705-09 Same as BL-5705-08 except swivels at vacuum breaker (right)
BL-5705-08-VR Same as BL-5705-08 except with anti-rotation screws in base and vandal-resistant handle screw

BL-5705-09

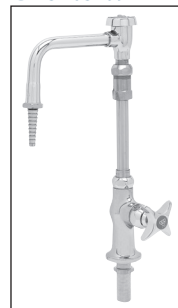



Single Lab Faucets

BL-5707-01 Single Science Table Faucet

- Single hole single temperature deck-mount laboratory faucet
- 1/2" NPSM male inlet
- 2" (51 mm) diameter base flange
- Two brass balls lock into table top indents to prevent vandalizing (drilling template included)
- 6-1/2" (166 mm) swivel/rigid vacuum breaker nozzle with serrated hose tip
- 12-13/16" (325 mm) height
- 1/2" NPT heavy duty riser pipe
- Quarter-turn Eterna cartridges with spring checks
- Deck gasket included
- Four arm handle with green cold water index and vandal-resistant screw
- Includes tailpiece and nut for 1/4" NPT connection (150A)
- (014200-45) lock washer included for rigid applications



BL-5707-03 Combination Science Table Faucet

- Combination science table faucet
- 1/2" NPSM male inlets
- 2" (51 mm) diameter on bases
- Brass balls lock into table top indents to prevent vandalizing (drilling template included)
- 12-13/16" (325 mm) height
- 5-11/16" (145 mm) spread vacuum breaker nozzles with serrated hose tips
- 1/2" NPT heavy duty riser pipes
- Quarter-turn Eterna cartridges with spring checks
- Deck gaskets included
- 6" (152 mm) distance between centers of faucets
- One hot index, one cold index
- Includes tailpieces and nuts for 1/4" NPT connections (150A)

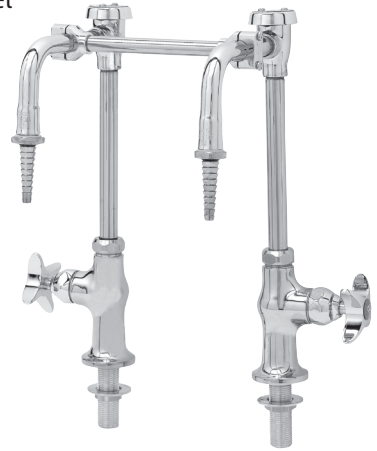

BL-5707 Models:

MODEL	1/4-Turn CARTRIDGE w/Cross Flow Prevention	OUTLET	HEIGHT	CLEARANCE	SPREAD	HANDLE	INLET	VR	NOTES
BL-5707-01	Eterna	Swivel-rigid V.B. nozzle with serrated hose tip	12-13/16"	6-1/2"	5-11/16"	Four-Arm Lab	1/2" NPSM male inlet	Y	Single temperature; V.R. handle screw
BL-5707-01CRWH4	Cerama	Swivel-rigid V.B. nozzle with serrated hose tip	12-13/16"	6-1/2"	5-11/16"	4" Wrist-Action	1/2" NPSM male inlet	Y	Single temperature; V.R. handle screw
BL-5707-01L-QT	Eterna	Swivel-rigid V.B. nozzle with serrated hose tip	12-13/16"	6-1/2"	5-11/16"	Lever	1/2" NPSM male inlet	Y	Single temperature; V.R. handle screw
BL-5707-03	Eterna	(Two) Swivel-rigid V.B. nozzles with serrated hose tips	12-13/16"	6-1/2"	5-11/16"	Four-Arm Lab	(2) 1/2" NPSM male inlets	Y	Combination lab faucet; V.R. handle screw

VR Vandal-resistant

Single Lab Faucets



BL-5709-01 Single Ledge Faucet

Identical to the BL-5705-01 Family of Faucets

- Single hole deck mount laboratory mixing faucet
- 5-7/8" (149 mm) swivel/rigid gooseneck with serrated hose tip
- 14-1/8" (359 mm) height
- 7-5/16" (186 mm) clearance
- Deck gasket included
- 1/2" NPSM male inlet
- Quarter-turn Eterna cartridges with spring checks
- Four arm handle with green cold water index
- Fits counters up to 1-1/2" (28 mm) thick
- Includes tailpiece and nut for 1/4" NPT connection (150A)



MODEL	1/4-Turn CARTRIDGE w/Cross Flow Prevention	OUTLET	HEIGHT	CLEARANCE	SPREAD	HANDLE	INLET	VR	NOTES
BL-5709-01	Eterna	Swivel-rigid gooseneck with serrated hose tip	14-1/8"	7-5/16"	5-7/8"	Four-Arm Lab	1/2" NPSM male inlet	Y	Single temperature; V.R. handle screw
BL-5709-05	Cerama	Swivel-rigid V.B. nozzle with serrated hose tips	12-13/16"	6-1/2"	5-11/16"	4" Wrist-Action	1/2" NPSM male inlet	Y	Single temperature; V.R. handle screw
BL-5709-08WH4	Eterna	Swivel-rigid V.B. nozzle with serrated hose tip	12-13/16"	6-1/2"	5-11/16"	4" Wrist-Action	1/2" NPSM male inlet	Y	Single temperature; V.R. handle screw

VR Vandal-resistant



Lab Faucets

BL-5710-01
Single Sink Faucet

- Single hole single temperature wall mount laboratory faucet
- 1/2" NPT female inlet with 2-3/16" (55 mm) dia. flange
- 5-5/8" (143 mm) swivel/rigid gooseneck with serrated hose tip
- 11-7/16" (291 mm) height from center of inlet to top of gooseneck
- 8-7/16" (214 mm) distance from wall to outlet
- Quarter-turn Eterna cartridges with spring checks
- Four arm handle with green cold water index
- (014200-45) lock washer included for rigid applications



BL-5710-07 Same as BL-5710-01 except with 5-11/16" (144 mm) swivel/rigid vacuum breaker nozzle

BL-5860-01TL Same as BL-5710-01 except is interior tin-lined for distilled water, with four arm handle

BL-5725-08
Sink Mixing Faucet

- 8" wall mount laboratory mixing faucet
- 5-11/16" (144 mm) swivel vacuum breaker nozzle with serrated hose tip
- 1/2" NPT female eccentric flanged inlets
- Quarter-turn Eterna cartridges with spring checks
- Four arm handles with color coded indexes
- 9-9/16" (243 mm) height from center of inlet to top of gooseneck



BL-5725-01



BL-5725-01 Same as BL-5725-08 except with 5-7/8" (149 mm) swivel/rigid gooseneck (inset, right)

BL-5725-09 Same as BL-5725-08 except swivels at vacuum breaker

BL-5725-09CRWH4 Same as BL-5715-09 except with Quarter-turn Cerama cartridges and 4" wrist action handles

BL-5715-08
Ledge Mixing Faucet

- 8" deck mount laboratory mixing faucet
- 5-11/16" (144 mm) swivel/rigid vacuum breaker nozzle with serrated hose tip
- 1/2" NPT female eccentric flanged inlets (00AA)
- Quarter-turn Eterna cartridges with spring checks
- Four arm handles with color coded indexes
- 12" (305 mm) height from deck to top of vacuum breaker
- 5-3/4" (146 mm) clearance
- (014200-45) lock washer included for rigid applications



BL-5715-01



BL-5715-09



BL-5715-01 Same as BL-5715-08 except with 5-5/8" (143 mm) swivel/rigid gooseneck (inset, above left)

BL-5715-09 Same as BL-5715-08 except swivels at vacuum breaker (inset, above right)

BL-5715-09CRWH4 Same as BL-5715-09 except with Quarter-turn Cerama cartridges and 4" wrist action handles

BL-5735-01
Wall Mounted Mixing Faucet

- 1/2" NPT female vertical inlets (hot on top, cold on bottom)
- 5-3/4" (146 mm) rigid gooseneck with serrated hose tip
- Eterna cartridges
- Four arm handles with color coded indexes



BL-5735-09 Same as BL-5735-08 except with swivel at the vacuum breaker

BL-5735-02 Same as BL-5735-01 except with 5-7/8" (150 mm) swivel gooseneck



Lab Faucets

BL-5740-01 Sink Mixing Faucet

- Wall mount mixing faucet
- 1/2" NPT female flanged adjustable arm inlets
- Adjustable centers from 2-1/4" (57 mm) to 8-1/4" (210 mm)
- 5-7/8" (149 mm) swivel/rigid gooseneck with serrated hose tip
- Quarter-turn Eterna cartridges with spring checks
- Four arm handles with color coded indexes
- 11-1/16" (281 mm) height from center of faucet to top of gooseneck
- 8-15/16" (227 mm) from wall to outlet of gooseneck
- (014200-45) lock washer included for rigid applications



BL-5740-08 Same as BL-5740-01 except with swivel/rigid vacuum breaker nozzle

BL-5755-01 Single Temperature Lab Faucet

- Single hole single temperature deck mount faucet
- 1/2" NPSM male inlet
- Fits counters up to 1-1/2" (38 mm) thick
- 9" (229 mm) swing nozzle with stream regulator outlet
- Quarter-turn Eterna cartridges with spring check
- Four arm handle with green cold water index
- Includes tailpiece and nut for 1/4" NPT connection (150A)



BL-5800-02 Single Supply Lab Faucet

- Single temperature wall mount faucet
- Serrated hose tip
- Eterna cartridge
- Four arm handle with green cold water index
- 1/2" NPT female inlet
- 3-11/16" (94 mm) spread



BL-5750-01 Sink Mixing Faucet

- Single hole deck mount mixing faucet
- 9" (229 mm) swing nozzle with stream regulator outlet
- Quarter-turn Eterna cartridges with spring check
- Four arm handles with color coded indexes
- 18" flexible inlet hoses (compression fittings for 5/8" O.D. tubing or 1/2" NPSM male thread)
- (014200-45) lock washer included for rigid applications



BL-5775-08 Sink Mixing Faucet

- 8" (203 mm) wall mount mixing faucet
- 1/2" NPT female eccentric flanged adjustable inlets (00AA)
- 8-3/4" (222 mm) vacuum breaker swing nozzle with serrated hose tip
- Quarter-turn Eterna cartridges with spring checks
- Four arm handles with color coded indexes



BL-5775-01 Same as BL-5775-08 except with 9" (229 mm) swing nozzle (no vacuum breaker) and stream regulator outlet

BL-5850-01 Single Self-Closing Ledge Faucet

- Single hole single temperature wall mount laboratory faucet
- 1/2" NPT male inlet
- 5-7/8" (149 mm) rigid gooseneck with serrated hose tip
- 14-3/16" (360 mm) height
- Fast self-closing cartridge
- Four arm handle with green cold water index
- Includes tailpiece and nut for 1/4" NPT connection (150A)



BL-5850-01TL Same as BL-5850-01 except the interior is tin-lined for distilled water

Lab Faucets

BL-6000-02
Combination Gas and Water Faucet



- Combination unit with gooseneck and two ball valve hose cocks with gas indexes
- 3/8" NPT male inlets for water and gas
- 6-1/16" (154 mm) gooseneck with serrated hose tip
- Compression cartridge
- 10-11/16" (271 mm) height
- Four arm handle with green cold water index
- Furnished with two (2) supply nipples, special lock washer, lock nuts and mounting gasket



BL-6000-03 Same as BL-6000-02 except 15-5/16" (389 mm) height and 8" (203 mm) spread gooseneck

BL-6005-02
Combination Gas and Water Faucet



- Combination unit with rigid vacuum breaker nozzle and two ball valve hose cocks with gas indexes
- 3/8" NPT male inlets for water and gas
- 6-1/16" (154 mm) vacuum breaker gooseneck with serrated hose tip
- Compression cartridge
- 11-1/2" (292 mm) height
- Four arm handle with green cold water index
- Furnished with two (2) supply nipples, special lock washer, lock nuts and mounting gasket



BL-6005-03 Same as BL-6005-02 except with 7-15/16 (202 mm) gooseneck

Lab Faucets and Miscellaneous Fixtures

BL-6050-01
Multi-Water Fixture

- 2" (51 mm) diameter turret
- 1/2" NPT female inlet
- 18-1/4" (463 mm) overall height
- 5-5/8" (143 mm) rigid gooseneck with serrated hose tip
- Gooseneck control valve with Eterna cartridge
- Side straight water stop with serrated tip and Eterna cartridge
- Four arm handles with green cold water index

Note: BL-5500-12 supply nipple and lock nut sold separately



BL-6050-02 Same as BL-6050-01 except with two bottom valves at 180°

BL-9505-01
PVC Single Ledge Faucet
Compression Type

- Single hole single temperature deck mount PVC faucet
- 6-3/16" (157 mm) rigid gooseneck with serrated hose tip
- 1-1/4" (32 mm) diameter threaded shank and locknut
- 3/8" NPT female inlet
- All PVC for use with distilled water
- Knob handle with white distilled water index
- 11-7/8" (302 mm) height



BL-9505-02 Same as BL-9505-01 except no shank and lock nut, with 1/2" NPT female inlet

BL-9515-01
PVC Single Ledge Faucet Self-Closing



- Single hole single temperature deck mount PVC faucet
- 6-3/16" (157 mm) rigid gooseneck with serrated hose tip
- Dual lever control for manual (up) or self-closing (down) operation
- 1-1/4" (32 mm) dia. shank and locknut
- 3/8" NPT female inlet
- All PVC for use with distilled water
- 11-7/8" (302 mm) height



BL-9515-02 Same as BL-9515-01 except no shank and lock nut, with 1/2" NPT female inlet

Lab Accessories

BL-5500-0
Filter Pump (Aspirator)

- 3/8" NPT male inlet
- Includes check valve
- 2-15/16" (75 mm) overall length
- Creates suction by water flow



Lab Accessories

BL-5500-07 Supply Nipple Unit

- Supply nipple and lock nut
- 3/8" NPT male ends
- 2-1/8" (54 mm) long
- Used with panel flanges

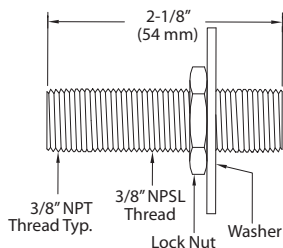

BL-5500-09 Same as BL-5500-07 except with 1/2" NPT male ends, 2" (51 mm) long for use on panel mount faucets

BL-5505-07 Four Arm Handle

- Black polypropylene with green cold water index
- 193LC Blue cold water index and screw with handle
- 193LH Red hot water index and screw with handle (shown)



BL-5545-01 Volume Control Unit

- Volume control fitting
- Adjustable volume from 0.1 GPM to 3.0 GPM @ 60 PSI
- 3/8" NPT inlet and outlet



BL-5500-10 Supply Nipple Unit

- 3/8" supply nipple, lock nut and washer
- 3/8" NPT male ends
- 4-3/4" (121 mm) long
- For use with BL-4100 turret series

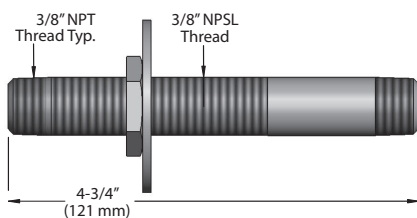

BL-5550-04 Straight Serrated Hose Tip

- 3/8" (9 mm) NPT male inlet
- Serrated hose tip accepts plastic or rubber up to 1/2" I.D.
- 2-5/8" (67 mm) long
- Fits lab goosenecks and nozzles

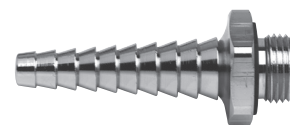

BL-5550-05 Same as BL-5550-04 except with angle tip

BL-5550-09 Vacuum Breaker

- Anti-siphon vacuum breaker prevents back siphonage
- 3/8" NPT male inlet and female outlet
- Used on outlets of goosenecks
- Use BL-5550-04 on tip on outlet



BL-5550-10 Vacuum Breaker

- Garden hose vacuum breaker prevents back siphonage
- 3/4" female garden hose inlet and male outlet
- Used to attach garden hose to unprotected hose bibb outlets
- Includes rubber washer and set screw



BL-5550-12 Vandal Resistant Aerator

- 2.2 GPM vandal-resistant aerator
- 3/8" NPSM male inlet
- Use special wrench to attach (included)
- 3/4" total length
- Fits lab goosenecks and nozzles



BL-5550-23 Rigid to Swivel Adapter

- Rigid to swivel adapter
- Accepts T&S swivel goosenecks and swing nozzles
- Use for field conversion where a faucet with 3/8" NPT outlet is installed and a swivel gooseneck or nozzle is required
- 1-5/16" (33 mm) height



Lab Accessories

BL-5561-02 Lab Nozzle

- 9" (229 mm) lab nozzle
- Stream regulator outlet
- Fits swivel faucets



BL-5561-03 Same as BL-5561-02 except 12" (305 mm) spread

BL-5707-10 Vandal Resistant Brace

- 6" (152 mm) vandal-resistant brace
- For use on lab equipment
- Two split clamps fit tightly on 3/8" NPS pipe



BL-5560-01 Rigid Gooseneck with Vacuum Breaker

- 3/8" NPT male inlet
- Serrated hose tip
- 8-7/8" (225 mm) total height
- 5-11/16" (144 mm) spread



BL-5560-02 Same as BL-5560-01 except with swivel connection at vacuum breaker

BL-5550-30 Restricted Swing Adapter

- Fits rigid outlet faucets (3/8" NPT female)
- Restricts the swivel action to 100°
- Includes special swivel adapter with restrictor pins to convert existing swing nozzles and swivel goosenecks
- Not for rigid goosenecks



Loose Key Stops

B-0415 Straight Loose Key Stop

- 3/8" NPT female inlet and outlet
- Includes loose key tee handle



B-0416 Same as B-0415 except with 1/2" NPT female inlet and outlet

B-1305 Angle Loose Key Stop

- Flexible supply assembly with loose key angle stop
- 1/2" NPT female inlet
- 1/2" O.D. x 12" (305 mm) long flexible copper tube
- 2-1/2" (64 mm) diameter wall flange
- Includes loose key tee handle and screw



B-1305-01 Same as B-1305 except with 3/8" O.D. flexible copper tube

B-1306 Same as B-1305 except with 3/8" NPT female inlet

B-1306-01 Same as B-1306 except with 3/8" O.D. flexible copper tube

B-0418 Angle Loose Key Stop

- 1/2" NPT female inlet and outlet
- Includes loose key tee handle

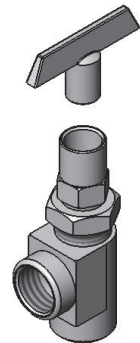

B-1311 Angle Key Stop

- 3/8" NPT female inlet
- Outlet with compression nut and sleeve to fit 1/2" (13 mm) O.D. copper tubing
- Includes loose key tee handle and screw



B-1336 Angle Key Stop

- 3/8" NPT female inlet
- 3/8" NPT female outlet
- Includes loose key tee handle and screw
- Vandal resistant (loose key stop)

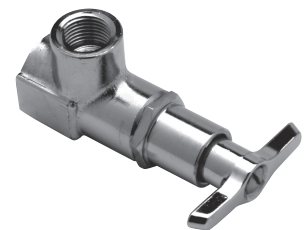

Loose Key Stops

B-1340 Angle Stop



- 1/2" NPT female inlet
- Eterna compression cartridge
- Four arm handle with blue index (175FC)
- Outlet with compression nut and sleeve to fit 1/2" (13 mm) O.D. copper tubing



B-1341 Same as B-1340 except with 3/8" NPT female inlet

B-1344 Angle Stop



- Angle stop with four arm handle
- Eterna cartridge
- 1/2" NPT female inlet, 3/8" NPT female outlet



B-1350 Angle Loose Key Stop

- 1/2" NPT female inlet
- Loose key spindle assembly (124A)
- 1/2" NPT male union coupling outlet
- 2" (51 mm) diameter adjustable flange
- Includes loose key tee handle and screw



B-1351 Same as B-1350 except with 3/8" NPT female union coupled outlet

B-1342 Loose Key Angle Stop

- 1/2" NPT female inlet
- Loose key spindle assembly (124A)
- Outlet with compression nut and sleeve to fit 1/2" (13 mm) O.D. copper tubing
- Includes loose key tee handle and screw

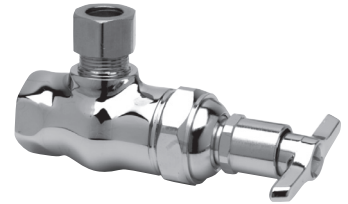

B-1346 Loose Key Angle Stop

- 1/2" NPT female inlet
- Loose key spindle assembly (124A)
- 3/8" NPT female outlet
- Includes loose key tee handle and screw



B-1355 Angle Loose Key Stop



- 3/8" NPT female union coupling inlet
- Loose key spindle assembly (124A)
- 3/8" NPT female outlet
- 2" (51 mm) diameter adjustable flange
- Includes loose key tee handle and screw



Low Flow Outlets
For Water Conservation Plumbing Models

Aerators



		Series 1	Series 2	Series 3	Series 4	Series 5
	Flow Rate	<ul style="list-style-type: none"> • 55/64-27 UN female aerator threads • Fits all swing nozzles and 131X and 133X goosenecks 	<ul style="list-style-type: none"> • Includes 3/8" NPSM male thread adapter (044A) and washer (001043-45) • Fits goosenecks except 131X and 133X 	<ul style="list-style-type: none"> • 13/16-27 UN male aerator thread • Fits lavatory spouts 	<ul style="list-style-type: none"> • 15/16-27 UN male aerator thread • Fits single lever line 	<ul style="list-style-type: none"> • 13/16-24 UN female thread • Fits other manufacturer's faucets • Includes adapter and washer
Stream Regulators						
<ul style="list-style-type: none"> • Stream regulators: <ul style="list-style-type: none"> – Full flow rate – Stream regulators straighten the water flow 	Full flow	 <p>B-PT</p> <ul style="list-style-type: none"> • Female aerator thread 	 <p>B-LT</p> <ul style="list-style-type: none"> • 3/8" male thread • Plain outlet 	-	-	-
Aerators						
<ul style="list-style-type: none"> • Aerators: <ul style="list-style-type: none"> – Non-splash stream 	2.2 GPM (8.3 L/min)	B-0199-01	B-0199-02	B-0199-03	B-0199-04	-
	1.5 GPM (5.7 L/min)	B-0199-01-WS	B-0199-02-WS	B-0199-03-WS	B-0199-04-WS	B-0199-05-WS
	1.2 GPM (4.54 L/min)	B-0199-01-F12	B-0199-02-F12	B-0199-03-F12	B-0199-04-F12	-
	1.0 GPM (3.8 L/min)	B-0199-01-F10	B-0199-02-F10	B-0199-03-F10	-	-
Vandal-Resistant Aerators						
<ul style="list-style-type: none"> • VR Aerators: <ul style="list-style-type: none"> – Non-splash stream – Vandal-resistant key included to attach and remove outlet (015425-45) 	2.2 GPM (8.3 L/min)	B-0199-06	B-0199-07	B-0199-08	B-0199-09	-
	1.5 GPM (5.7 L/min)	B-0199-06-WS	B-0199-07-WS	B-0199-08-WS	B-0199-09-WS	B-0199-10-WS
	1.2 GPM (4.54 L/min)	B-0199-06-F12	B-0199-07-F12	B-0199-08-F12	B-0199-09-F12	-
	1.0 GPM (3.8 L/min)	B-0199-06-F10	B-0199-07-F10	B-0199-08-F10	-	-

Laminar Flow Outlets/Non-Aerated Spray Devices
For Water Conservation Plumbing Models

Laminar Flow Outlets and Non-Aerated Spray Devices



	Flow Rate	Series 1	Series 2	Series 3	Series 4	Series 5
Laminar Flow Devices <ul style="list-style-type: none"> • Non-aerated stream • Screenless 	2.2 GPM (8.3 L/min)	B-0199-21	-	B-0199-26	B-0199-25	-
	1.5 GPM (5.7 L/min)	B-0199-29	-	-	-	-
	1.2 GPM (4.54 L/min)	B-0199-01-LF12	-	-	B-0199-04-LF12	-
Vandal-Resistant Laminar Flow Devices <ul style="list-style-type: none"> • Non-aerated stream • Screenless • Vandal-resistant with key (015425-45) • -VR - female thread • -VRF - female thread • -VRM - male thread 	2.2 GPM (8.3 L/min)	B-0199-21-VRF	-	B-0199-28	B-0199-27	-
	1.5 GPM (5.7 L/min)	B-0199-29VR	-	B-0199-08-LF15	B-0199-09-LF15	-
	1.0 GPM (3.8 L/min)	B-0199-06-LF10	-	B-0199-08-LF10	B-0199-09-LF10	-
	1.2 GPM (4.54 L/min)	B-0199-06-LF12	-	-	-	-
Non-Aerated Spray Devices <ul style="list-style-type: none"> • Non-aerated spray pattern • Screenless • For use in medical facilities to prevent bacteria from entering water stream 	0.35 GPM (1.3 L/min)	B-0199-01-N035	B-0199-02-N035	B-0199-03-N035	B-0199-04-N035	B-0199-05-N035
	0.5 GPM (1.9 L/min)	B-0199-01-N05	B-0199-02-N05	B-0199-03-N05	B-0199-04-N05	B-0199-05-N05
Vandal Resistant Non-Aerated Spray Devices <ul style="list-style-type: none"> • Non-aerated spray pattern • Screenless • For use in medical facilities to prevent bacteria from entering water stream • Vandal-resistant key included to attach and remove outlet (015425-45) 	0.35 GPM (1.3 L/min)	B-0199-06-N035	B-0199-07-N035	B-0199-08-N035	B-0199-09-N035	B-0199-10-N035
	0.5 GPM (1.9 L/min)	B-0199-06-N05	B-0199-07-N05	B-0199-08-N05	B-0199-09-N05	B-0199-10-N05



RELIABILITY BUILT IN™

G-12

E *Washdown and Clean-up Solutions*



Featuring Our B-7102 Series 12' Compact Open Stainless Steel Hose Reel



B-7102-01

- [B-7102](#) Hose Reel – no Spray Valve
- [B-7102-01](#) EB-0107 High-Flow Spray Valve
- [B-7102-01M](#) B-0107 Spray Valve
- [B-7102-08H](#) B-0108-H High-Flow JeTSpray
- [B-7102-08M](#) with B-0108 JeTSpray Valve

Our T&S 12' (3/8" I.D.) Hose Reel is a compact, light-weight, professional-grade spring driven hose reel that is small enough to be used in applications where space is at a premium. Its compact size allows it to be mounted under the counter or in any other small space.

This reel is designed for equipment fabricators or anyone else seeking a compact, stainless steel, heavy-duty, professional-grade hose reel.

Fill your dipperwells, clean out dish machines or spray down combi ovens with a B-7102 Hose Reel, the market's first compact stainless steel reel built for heavy-duty applications. Daily work is simpler thanks to hose reels designed with the end user in mind.

See how the **B-7102 Series 12' Hose Reel** can help you work more efficiently and safely at www.tsbrass.com

Dynamic Features and Benefits

Feature	Function	Benefit
Adjustable Arm	Hose reel arm is adjustable to three different positions.	Gives user greater flexibility for their particular application. Adjustability allows arm to be either in wall mount or under counter mount position.
Anti-Lockout Ratchet Design	When hose is fully extended, ratchet pawl is inbetween two sets of locking gears.	Allows hose to retract freely. Eliminates need to manually rewind the hose.
Brass Swivel on Stainless Shaft	Eliminates a condition known as "galling" where excessive friction between like metals results in localized welding with subsequent splitting of one or both of two mating parts.	Reduces risk of rusting, leaking and potentially an unusable hose reel.
Hose (12', 3/8" I.D.)	Hose has a nitrile tube and oil-resistant synthetic rubber jacket with a synthetic yarn braid for reinforcement. Rated up to 200°F and 300 psi.	Hose has better oil and grease resistant properties than PVC or EPDM rubber hose.
Impact Resistant Ratcheting Assembly	Ratchet plate is 1/4" thick stainless steel with six catch points. Ratchet pawl is made from corrosion resistant steel.	Longer service life as compared to others where the parts are made from plastic and tend to break under stress.
Mounting Base	Contains multiple holes and slots.	Makes reel easier to retrofit to existing mounting patterns. Eliminates need to drill additional holes to a specific mounting pattern.
Protected Hose Outlet	Hose outlet contains a full guide bushing that rims the opening.	Allows the hose to move freely across guide bushing instead of against metal. Hose doesn't bind in corners as it can in outlets with only four rollers, resulting in longer hose jacket life.
Hose Swivel 360°	Hose reel hose spray valve hex swivel.	Allows spray valve to rotate freely.

T&S Brass and Bronze Works, Inc.
2 Saddleback Cove • P.O. Box 1088 • Travelers Rest, SC 29690
Ph 864.834.6715 • Fax 864.834.3518

www.tsbrass.com



Need a hose reel system? T&S' new smart modeling number system makes it easy

T&S can help you configure a custom system based on your needs with a wide variety of options. Your choices for each option are shown step-by-step.

Follow the steps below to specify the hose reel *you* want.

E
4

B-7 2 2 2 C 01 W S2 E

We have everything you need.

Option	# Choices and Description
1 Hose reel materials	2 • Stainless • Epoxy-Coated
2 Hose lengths	4 • 15' • 30' • 35' • 50'
3 Hose diameters	2 • 3/8" • 1/2"
4 Reel types	2 • Open • Closed
5 Spray valves	8 • EB-0107 • B-0107 • MV-2516-24 • MV-2522-24 • B-0108-H • B-0108 • EB-2322 • MV-3516-24
6 Mounting brackets	3 • Wall Swing • Table Leg • Pivot-Ceiling • No bracket
7 System types	5 • 8" Wall mount • 8" Wall mount w/in-line check valves • Concealed base • 8" Deck mount • Cabinet
8 Cartridge types	2 • Eterna • Cerama

1 **B-7 2**

Hose reel materials

STAINLESS **1** EPOXY-COATED **2**

2 **B-7 2 2**

Hose lengths

15' **1** OPEN REELS ONLY

30' **2** CLOSED REELS ONLY

35' **3** OPEN REELS ONLY

50' **4**

3 **B-7 2 2 2**

Hose diameters

3/8" **2**

1/2" **3** STAINLESS REELS ONLY

4 **B-7 2 2 2 C**

Reel types

OPEN **U** CLOSED **C**
3/8" ONLY

See p. E6-7 for more information about options and available models



The best choice to ensure code compliance and efficiency

- One purchase
- Hassle-free
- One easy-to-order solution
- Code-compliant

We offer a wide selection of complete hose reel system models. See the list of available models and more information on p. E6-7.

5 B-7 2 2 2 C 01

Spray valves

EB-0107 01 B-0107 1L MV-2516-24 02 MV-2522-24 05
 B-0108-H 08 B-0108 8L EB-2322 10 MV-3516-24 11

All the necessary parts to ensure **code compliance** and **efficiency**

QUICK DISCONNECTS VACUUM BREAKERS FLEXIBLE HOSE CONNECTIONS

6 B-7 2 2 2 C 01 W

Mounting brackets

WALL SWING G019430-45 TABLE LEG G018477-45 PIVOT/CEILING G016652-45 NO BRACKET

W T P X

When you choose a T&S hose reel system, you get it all.

7 B-7 2 2 2 C 01 W S2

System types

8" WALL MOUNT S1 8" WALL MOUNT WITH IN-LINE CHECK VALVES S2 CONCEALED BASE WITH IN-LINE CHECK VALVES S3
 8" DECK MOUNT S4 CABINET S5

A range of available options for unique applications

Foodservice C-Stores Manufacturing Medical Education

Be sure to watch our video about T&S hose reel systems: www.tsbrass.com/resources/videos/all-about-hose-reels

8 B-7 2 2 2 C 01 W S2 E

Cartridge types

ETERNA E CERAMA C

The **smart** choice to ensure code compliance and efficiency





The best choice for hose reel system options

We offer a wide selection of complete hose reel system models

S1 System Type

S2 System Type

S3 System Type

- 1 Flexible hose connections
- 2 Vacuum breakers
- 3 Open and Enclosed Hose Reels with various length hoses
- 4 Water guns / Spray valves
- 5 Includes Shut-off valves, Check valves, Risers, and Wall brackets
- 6 Mixing valves and faucet bases

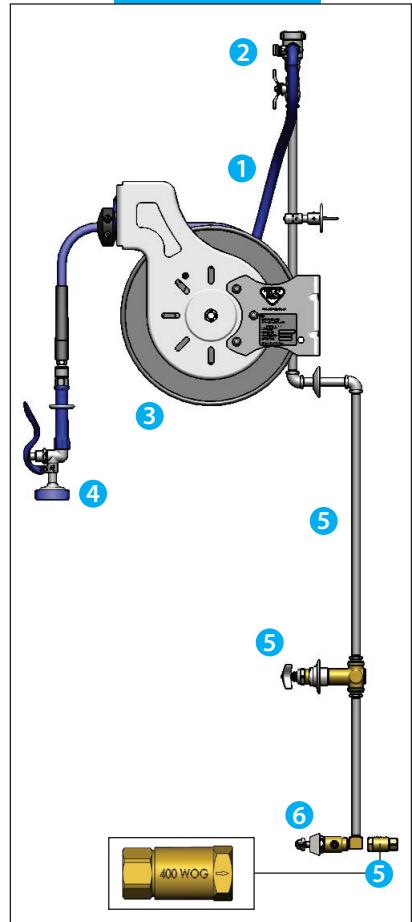
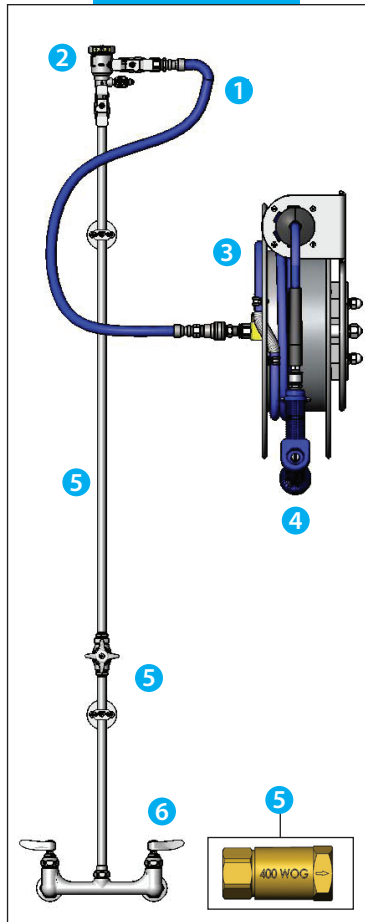
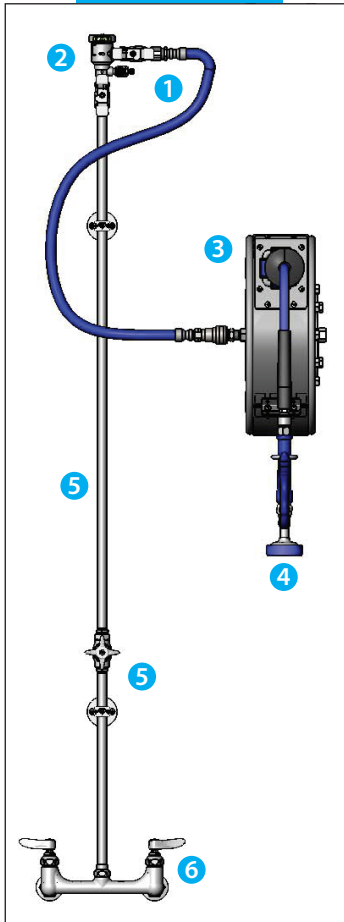

T&S can help you configure a custom system based on your needs with a wide variety of options



RELIABILITY BUILT IN™





Smart model number key for complete hose reel systems

Example:

B-7 2 3 2 - U 01 W S1 E

<p>Reel Material</p> <p>1 = Stainless Steel</p> <p>2 = Epoxy-Coated Steel</p>	<p>Hose Length –</p> <p>3/8" Diameter Options</p> <p>1 = 15' (open models only)</p> <p>2 = 30' (closed models only)</p> <p>3 = 35' (open models only)</p> <p>4 = 50'</p> <p>1/2" Diameter Options</p> <p>3 = 35' (open models only)</p> <p>4 = 50'</p>	<p>Diameter</p> <p>2 = 3/8"</p> <p>3 = 1/2" (stainless models only)</p> <p>Reel</p> <p>C = Closed (3/8" only)</p> <p>U = Open</p>	<p>Spray Valve</p> <p>01 = EB-0107</p> <p>1L = B-0107</p> <p>02 = MV-2516-24</p> <p>03 = MV-2516-34</p> <p>04 = MV-2516-44</p> <p>05 = MV-2522-24</p> <p>06 = MV-2522-34</p> <p>07 = MV-2522-44</p> <p>08 = B-0108-H</p> <p>8L = B-0108</p> <p>10 = EB-2322</p> <p>11 = MV-3516-24</p>	<p>Mounting Brackets</p> <p>P = Pivot/Ceiling Bracket</p> <p>W = Wall Swing Bracket</p> <p>T = Table Leg Bracket</p> <p>X = No Bracket</p>	<p>System Type*</p> <p>See chart below</p>	<p>Cartridge Type</p> <p>E = Eterna</p> <p>C = Cerama</p>
--	---	---	---	---	---	--

***System Type: Model (for example):**

<p>S1</p> <p>8" Wall Mount with Spring Checks</p>  <p>B-7232-U01XS1E</p>	<p>S2</p> <p>8" Wall Mount with In-line Check Valves</p>  <p>B-7232-U01XS2E</p>	<p>S3</p> <p>Concealed Base with In-line Check Valves</p>  <p>B-7232-U01XS3</p> <p><i>(Cartridge option N/A for S3)</i></p>	<p>S4</p> <p>8" Deck Mount</p>  <p>B-7232-U01WS4E</p>	<p>S5</p> <p>Cabinet</p>  <p>B-7232-U01XS5</p> <p><i>(Cartridge option N/A for S5)</i></p>
--	---	---	--	--

T&S Hose Reel Systems Models

B-7122-C01XS1E	B-7222-C01XS1E	B-7232-U01XS3
B-7212-U01WS1E	B-7232-U01WS1E	B-7232-U01WS4E
B-7212-U01XS1E	B-7232-U01XS1E	B-7232-U01XS4E
B-7212-U01WS2E	B-7232-U01WS2E	B-7232-U01WS5
B-7212-U01XS2E	B-7232-U01XS2E	B-7232-U01XS5
B-7212-U01XS3	B-7232-U01WS3	B-7232-U05XS1E

OPEN Stainless Steel 3/8" Hose Reels

B-7102 SERIES 12' Compact Open Stainless Steel Hose Reel

Features

- Compact, lightweight, professional-grade, spring driven 3/8" x 12' hose reel
- Small enough to be used where space is a premium
- Adjustable arm for wall mount / under counter applications
- Anti-lockout ratchet design allows hose to retract freely
- Brass swivel on stainless shaft reduces risk of rust, leaks
- Hose has a nitrile tube and oil-resistant synthetic rubber jacket, rated up to 200°F and 300 PSI
- Impact-resistant ratcheting assembly means a longer life
- Mounting base with multiple holes and slots
- Protected hose outlet allows hose to move freely along guide bushing
- Hex swivel on hose allows spray valve to rotate 360°

**B-7102-01
Compact Open
Stainless Steel
Hose Reel**



12' Hose, 3/8" I.D.

B-7102	Hose Reel only – no Spray Valve
B-7102-01	EB-0107 High-Flow Blue Spray Valve
B-7102-01M	B-0107 Gray Spray Valve
B-7102-08H	B-0108-H JeTSpray High-Flow Spray Valve
B-7102-08M	B-0108 JeTSpray Valve
B-7102-01M-STB	B-0107 Gray Spray Valve and 180° Stainless Steel Table Leg Swing Bracket (See p. E13)

B-7112, B-7132 and B-7142 SERIES Open Hose Reels

Features

- Open reel with stainless steel finish
- Heavy-duty blue hose, 3/8" I.D., rated to 300 PSI
- Ratcheting system holds the length of hose until a slight tug; retracts automatically
- 3/8" NPT female inlet
- Adjustable hose bumper
- Multi-fit bracket for wall, ceiling or under counter mounting
- Hex swivel on hose allows spray valve to rotate 360°

Installation Note

If mixing valve is used, check valves should be installed to prevent cross flow of water.

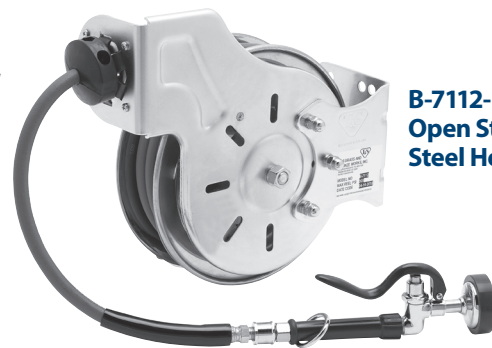

**B-7112-01
Open Stainless
Steel Hose Reel**

15' Hose, 3/8" I.D.

B-7112-01	EB-0107 High-Flow Blue Spray Valve (shown, right)
B-7112-01M	B-0107 Spray Valve
B-7112-02	MV-2516-24 Rear Trigger Water Gun
B-7112-05	MV-2522-24 Front Trigger Water Gun
B-7112-08H	B-0108-H JeTSpray High-Flow Spray Valve
B-7112-08M	B-0108 JeTSpray Valve
B-7112-10	EB-2322 Extended Spray Wand

35' Hose, 3/8" I.D.

B-7132-01	EB-0107 High-Flow Blue Spray Valve
B-7132-01-ESB	EB-0107 High-Flow Blue Spray Valve and 100° EasyInstall Stainless Steel Swing Bracket
B-7132-01M	B-0107 Spray Valve
B-7132-02	MV-2516-24 Rear Trigger Water Gun
B-7132-05	MV-2522-24 Front Trigger Water Gun
B-7132-08H	B-0108-H JeTSpray High-Flow Spray Valve
B-7132-08M	B-0108 JeTSpray Valve
B-7132-10	EB-2322 Extended Spray Wand

Spray Outlet Options

(All models this page; see chart, p. E9)

- Spray valves with heat-resistant handles
- Heavy-duty water guns
- Extended spray wand

50' Hose, 3/8" I.D.

B-7142-01	EB-0107 High-Flow Blue Spray Valve
B-7142-01M	B-0107 Spray Valve
B-7142-02	MV-2516-24 Rear Trigger Water Gun
B-7142-05	MV-2522-24 Front Trigger Water Gun
B-7142-08H	B-0108-H JeTSpray High-Flow Spray Valve
B-7142-08M	B-0108 JeTSpray Valve
B-7142-10	EB-2322 Extended Spray Wand

OPEN Stainless Steel 1/2" Hose Reels

NEW! B-7133 and B-7143 SERIES 1/2" Open Hose Reels

Features

- 1/2" open stainless steel hose reels
- Heavy-duty blue hose, 1/2" I.D., rated to 300 PSI
- Ratcheting system holds the length of hose until a slight tug; retracts automatically
- 1/2" NPT female inlet
- Adjustable hose bumper
- Hex swivel on hose allows spray valve to rotate 360°

Installation Note

If mixing valve is used, check valves should be installed to prevent cross flow of water.



**B-7133-01
Open Stainless
Steel Hose Reel**

35' Hose, 1/2" I.D.

B-7133	Hose Reel only – no Spray Valve
B-7133-01	EB-0107 High-Flow Blue Spray Valve
B-7133-02	MV-2516-24 Stainless Steel Rear Trigger Water Gun
B-7133-03	MV-2516-34 Stainless Steel Rear Trigger Water Gun
B-7133-04	MV-2516-44 Stainless Steel Rear Trigger Water Gun
B-7133-05	MV-2522-24 Stainless Steel Front Trigger Water Gun
B-7133-06	MV-2516-34 Stainless Steel Front Trigger Water Gun
B-7133-07	MV-2516-44 Stainless Steel Front Trigger Water Gun

50' Hose, 1/2" I.D.

B-7143	Hose Reel only – no Spray Valve
B-7143-01	EB-0107 High-Flow Blue Spray Valve
B-7143-02	MV-2516-24 Stainless Steel Rear Trigger Water Gun
B-7143-03	MV-2516-34 Stainless Steel Rear Trigger Water Gun
B-7143-04	MV-2516-44 Stainless Steel Rear Trigger Water Gun
B-7143-05	MV-2522-24 Stainless Steel Front Trigger Water Gun
B-7143-06	MV-2516-34 Stainless Steel Front Trigger Water Gun
B-7143-07	MV-2516-44 Stainless Steel Front Trigger Water Gun

**Hose Reel Model
Configurator –
see page E14**

Hose Reel Mounting Bracket Options

Three (3) mounting brackets are available for 3/8" and 1/2" hose reels. Refer to the chart below and p. E13 for descriptions of T&S hose reel mounting brackets.

Open and Enclosed Hose Reel Mounting Bracket SUFFIX GUIDE

Add a suffix to the Hose Reel model to specify which Mounting Bracket is being ordered on either an Open or Enclosed Hose Reel:

Suffix	Part Number	Description
-PPB	G016652-45	Epoxy Coated Steel Pivot Bracket
-STB	G018477-45	Stainless Steel Table Leg Swing Bracket
-ESB	G019430-45	Stainless Steel Universal 100° Rotation EasyInstall Stainless Steel Swing Bracket

Hose Reel Spray Outlet Options

See pages E21-23 for descriptions of all T&S Hose Reel Spray Outlets.

Open and Enclosed Hose Reel Spray Outlet SUFFIX GUIDE

A suffix added to the Hose Reel model indicates which Spray Outlet is being ordered:

Suffix	Spray Valve	Suffix	Spray Valve	Suffix	Spray Valve
-01	EB-0107	-04	MV-2516-44	-08M	B-0108
-C01	EB-0107	-05	MV-2522-24	-C08M	B-0108
-01M	B-0107	-C05	MV-2522-24	-10	EB-2322
-C01M	B-0107	-06	MV-2522-34	-C10	EB-2322
-02	MV-2516-24	-07	MV-2522-44	-11	MV-3516-24
-C02	MV-2516-24	-08H	B-0108-H	-C11	MV-3516-24
-03	MV-2516-34	-C08H	B-0108-H		

ENCLOSED Stainless Steel 3/8" Hose Reels

B-7122-C and B-7142-C SERIES Enclosed Hose Reels

Features

- Enclosed reel with stainless steel finish
- Heavy-duty blue hose, 3/8" I.D., rated to 300 PSI
- Ratcheting system holds the length of hose until a slight tug; retracts automatically
- 3/8" NPT female inlet
- Adjustable hose bumper
- Multi-fit bracket for wall, ceiling or under counter mounting
- Hex swivel on hose allows spray valve to rotate 360°

Installation Note

If mixing valve is used, check valves should be installed to prevent cross flow of water.

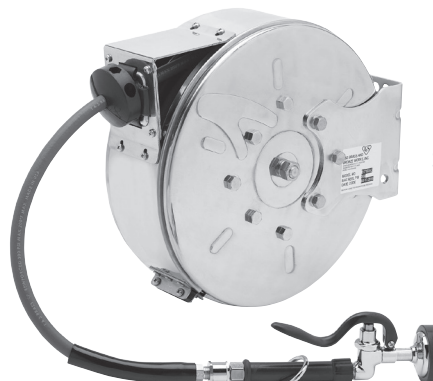

**B-7122-C01
Enclosed
Stainless Steel
Hose Reel**

30' Hose, 3/8" I.D.

B-7122-C01	EB-0107 High-Flow Blue Spray Valve (shown, above)
B-7122-C01-ESB	EB-0107 High-Flow Blue Spray Valve and 100° Rotation EasyInstall Stainless Steel Swing Bracket
B-7122-C01M	B-0107 Spray Valve
B-7122-C02	MV-2516-24 Rear Trigger Water Gun
B-7122-C05	MV-2522-24 Front Trigger Water Gun
B-7122-C08H	B-0108-H JeTSpray High-Flow Spray Valve
B-7122-C08M	B-0108 JeTSpray Valve
B-7122-C10	EB-2322 Extended Spray Wand

50' Hose, 3/8" I.D.

B-7142-C01	EB-0107 High-Flow Blue Spray Valve
B-7142-C01M	B-0107 Spray Valve
B-7142-C02	MV-2516-24 Rear Trigger Water Gun
B-7142-C05	MV-2522-24 Front Trigger Water Gun
B-7142-C08H	B-0108-H JeTSpray High-Flow Spray Valve
B-7142-C08M	B-0108 JeTSpray Valve
B-7142-C10	EB-2322 Extended Spray Wand

**Hose Reel Model
Configurator –
see page E14**

Hose Reel Mounting Bracket Options

Three (3) mounting brackets are available for 3/8" and 1/2" hose reels. Refer to the chart below and p. E13 for descriptions of T&S hose reel mounting brackets.

Open and Enclosed Hose Reel Mounting Bracket SUFFIX GUIDE

Add a suffix to the Hose Reel model to specify which Mounting Bracket is being ordered on either an Open or Enclosed Hose Reel:

Suffix	Part Number	Description
-PPB	G016652-45	Epoxy Coated Steel Pivot Bracket
-STB	G018477-45	Stainless Steel Table Leg Swing Bracket
-ESB	G019430-45	Stainless Steel Universal 100° Rotation EasyInstall Stainless Steel Swing Bracket

Hose Reel Spray Outlet Options

See pages E21-23 for descriptions of all T&S Hose Reel Spray Outlets.

Open and Enclosed Hose Reel Spray Outlet SUFFIX GUIDE

A suffix added to the Hose Reel model indicates which Spray Outlet is being ordered:

Suffix	Spray Valve	Suffix	Spray Valve	Suffix	Spray Valve
-01	EB-0107	-04	MV-2516-44	-08M	B-0108
-C01	EB-0107	-05	MV-2522-24	-C08M	B-0108
-01M	B-0107	-C05	MV-2522-24	-10	EB-2322
-C01M	B-0107	-06	MV-2522-34	-C10	EB-2322
-02	MV-2516-24	-07	MV-2522-44	-11	MV-3516-24
-C02	MV-2516-24	-08H	B-0108-H	-C11	MV-3516-24
-03	MV-2516-34	-C08H	B-0108-H		

OPEN Epoxy Coated Steel 3/8" Hose Reels

B-7212, B-7232, B-7242, and B-7245 SERIES Open Hose Reels

Features

- Open reel with epoxy coated steel finish
- Heavy-duty blue hose, 3/8" I.D., rated to 300 PSI
- Ratcheting system holds the length of hose until a slight tug; retracts automatically
- 3/8" NPT female inlet
- Adjustable hose bumper
- Multi-fit bracket for wall, ceiling or under counter mounting
- Hex swivel on hose allows spray valve to rotate 360°

Installation Note

If mixing valve is used, check valves should be installed to prevent cross flow of water.

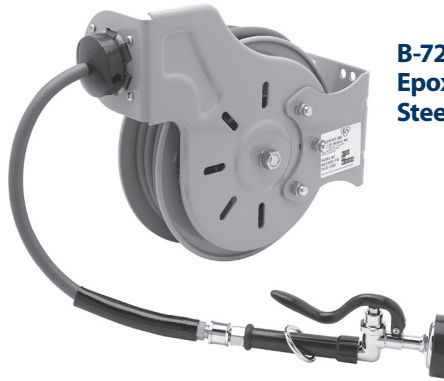

B-7212-01 Open Epoxy Coated Steel Hose Reel

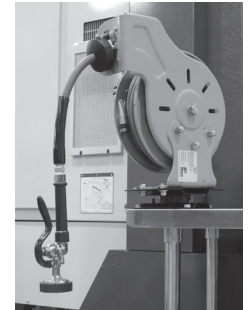

Shown with -PPB mounting bracket G016652-45

15' Hose, 3/8" I.D.

B-7212-01	EB-0107 High-Flow Blue Spray Valve (shown, above)
B-7212-01-ESB	EB-0107 High-Flow Blue Spray Valve and 100° Rotation EasyInstall Stainless Steel Swing Bracket
B-7212-01M	B-0107 Spray Valve
B-7212-02	MV-2516-24 Rear Trigger Water Gun
B-7212-05	MV-2522-24 Front Trigger Water Gun
B-7212-08H	B-0108-H JetSpray High-Flow Spray Valve
B-7212-08M	B-0108 JetSpray Valve
B-7212-10	EB-2322 Extended Spray Wand
B-7212-11	MV-3516-24 Aluminum Rear Trigger Water Gun

50' Hose, 3/8" I.D.

B-7242-01	EB-0107 High-Flow Blue Spray Valve
B-7242-01M	B-0107 Spray Valve
B-7242-02	MV-2516-24 Rear Trigger Water Gun
B-7242-05	MV-2522-24 Front Trigger Water Gun
B-7242-08H	B-0108-H JetSpray High-Flow Spray Valve
B-7242-10	EB-2322 Extended Spray Wand

35' Hose, 3/8" I.D.

B-7232-01	EB-0107 High-Flow Blue Spray Valve
B-7232-01-ESB	EB-0107 High-Flow Blue Spray Valve and 100° Rotation EasyInstall Stainless Steel Swing Bracket
B-7232-01M	B-0107 Spray Valve (1.42 gpm)
B-7232-02	MV-2516-24 Rear Trigger Water Gun
B-7232-05	MV-2522-24 Front Trigger Water Gun
B-7232-05-ESB36	MV-2522-24 Front Trigger Water Gun, 36" inlet hose and 100° Rotation EasyInstall Stainless Steel Swing Bracket
B-7232-05-ESB48	MV-2522-24 Front Trigger Water Gun, 48" inlet hose and 100° Rotation EasyInstall Stainless Steel Swing Bracket
B-7232-08H	B-0108-H JetSpray High-Flow Spray Valve
B-7232-08M	B-0108 JetSpray Valve
B-7232-10	EB-2322 Extended Spray Wand
B-7232-11	MV-3516-24 Aluminum Rear Trigger Water Gun

B-7245 Series Heavy-Duty Hose Reels

Features

- Open reel with epoxy coated steel finish
- 50' (15.2 m) industrial grade white hose, 3/4" I.D.
- Ratcheting system holds the length of hose until a slight tug; retracts automatically
- 3/4" NPT male and female inlet
- 1/2" NPT male swivel on outlet of hose; 3/4" male NPT inlet

Note: A mounting bracket cannot be specified with this hose reel



B-7245-06 Heavy-Duty Hose Reel

50' Hose, 3/4" I.D.

B-7245-03	MV-2516-34 7/16" Rear Trigger Water Gun
B-7245-04	MV-2516-44 9/16" Rear Trigger Water Gun
B-7245-06	MV-2522-34 7/16" Front Trigger Water Gun
B-7245-07	MV-2516-44 9/16" Front Trigger Water Gun

ENCLOSED Epoxy-Coated Steel 3/8" Hose Reels

B-7222 and B-7242 SERIES Enclosed Hose Reels

Features

- Enclosed reel with epoxy-coated steel finish
- Heavy-duty blue hose, 3/8" I.D., rated to 300 PSI
- Ratcheting system holds the length of hose until a slight tug; retracts automatically
- 3/8" NPT female inlet
- Adjustable hose bumper
- Multi-fit bracket for wall, ceiling or under counter mounting
 - Hex swivel on hose allows spray valve to rotate 360°

Installation Note

If mixing valve is used, check valves should be installed to prevent cross flow of water.



**B-7222-C01
Enclosed
Epoxy Coated
Steel Hose
Reel**

30' Hose, 3/8" I.D.

B-7222-C01	EB-0107 Blue Spray Valve (shown, above)
B-7222-C01-ESB	EB-0107 High-Flow Blue Spray Valve and 100° Rotation EasyInstall Stainless Steel Swing Bracket
B-7222-C01M	B-0107 Spray Valve
B-7222-C02	MV-2516-24 Rear Trigger Water Gun
B-7222-C05	MV-2522-24 Front Trigger Water Gun
B-7222-C08H	B-0108-H JeTSpray High-Flow Spray Valve
B-7222-C08M	B-0108 JeTSpray Valve
B-7222-C10	EB-2322 Extended Spray Wand
B-7222-C11	MV-3516-24 Aluminum Rear Trigger Water Gun

50' Hose, 3/8" I.D.

B-7242-C01	EB-0107 Blue Spray Valve
B-7242-C01M	B-0107 Spray Valve
B-7242-C02	MV-2516-24 Rear Trigger Water Gun
B-7242-C05	MV-2522-24 Front Trigger Water Gun
B-7242-C08H	B-0108-H JeTSpray High-Flow Spray Valve

**Hose Reel Model
Configurator –
see page E14**

Hose Reel Mounting Bracket Options

Three (3) mounting brackets are available for 3/8" and 1/2" hose reels. Refer to the chart below and p. E13 for descriptions of T&S hose reel mounting brackets.

Open and Enclosed Hose Reel Mounting Bracket SUFFIX GUIDE

Add a suffix to the Hose Reel model to specify which Mounting Bracket is being ordered on either an Open or Enclosed Hose Reel:

Suffix	Part Number	Description
-PPB	G016652-45	Epoxy Coated Steel Pivot Bracket
-STB	G018477-45	Stainless Steel Table Leg Swing Bracket
-ESB	G019430-45	Stainless Steel Universal 100° Rotation EasyInstall Stainless Steel Swing Bracket

Hose Reel Spray Outlet Options

See pages E21-23 for descriptions of all T&S Hose Reel Spray Outlets.

Open and Enclosed Hose Reel Spray Outlet SUFFIX GUIDE

A suffix added to the Hose Reel model indicates which Spray Outlet is being ordered:

Suffix	Spray Valve	Suffix	Spray Valve	Suffix	Spray Valve
-01	EB-0107	-04	MV-2516-44	-08M	B-0108
-C01	EB-0107	-05	MV-2522-24	-C08M	B-0108
-01M	B-0107	-C05	MV-2522-24	-10	EB-2322
-C01M	B-0107	-06	MV-2522-34	-C10	EB-2322
-02	MV-2516-24	-07	MV-2522-44	-11	MV-3516-24
-C02	MV-2516-24	-08H	B-0108-H	-C11	MV-3516-24
-03	MV-2516-34	-C08H	B-0108-H		

Other Standard and Compact Hose Reels

5R.M20.T449

Klarco Enclosed Stainless Steel 65' Hose Reel

- Enclosed stainless steel hose reel designed for heavy-duty use in kitchens
- 3/8" x 65' (DN 10 x 20m) food grade heavy-duty non-marking hose rated to 300 PSI
- Ratcheting system holds the length of hose until a slight tug to retract automatically
- Adjustable flow spray gun, 2.2 GPM @ 60 PSI
- Adjustable hose bumper
- Wall mount swivel bracket
- G 1/2 male inlet
- Pressure 20 - 125 PSI
- Temperature 40°F - 200°F



B-7161-C

6' Compact Hose Reel

- 6' compact hose reel with stainless steel enclosed housing
- Designed for light-duty cleaning
- Reinforced 1/4" x 6' black hose secured around an enclosed metal reel
- Anti-lockout feature ensures full retraction of hose even when fully extended
- All brass main swivel
- Push-button single stream spray valve
- 1/4-turn easy access shut-off valve on front panel
- 1/4" NPT brass inlet pipe and stainless steel braided flexible line
- Includes ratchet and hose guide repair kits

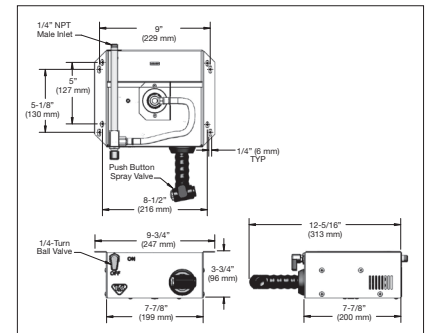

Note: A mounting bracket cannot be specified with this hose reel

Mounting Brackets

G016652-45

Pivot Bracket (-PPB)

- Epoxy coated black steel
- Fits all T&S 3/8" and 1/2" hose reels
- Add "-PPB" suffix to model number to specify this bracket (see page E14 for configurator)

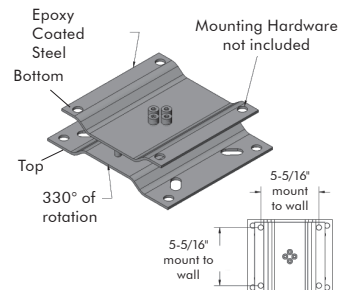
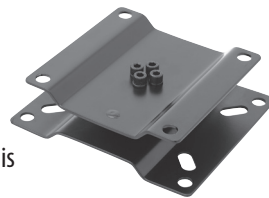

G018477-45

Table Leg Swing Bracket (-STB)

- Stainless steel hose reel swing bracket
- Fits all T&S 3/8" and 1/2" hose reels
- Spring loaded latch
- Add "-STB" suffix to model number to specify this bracket (see page E14 for configurator)

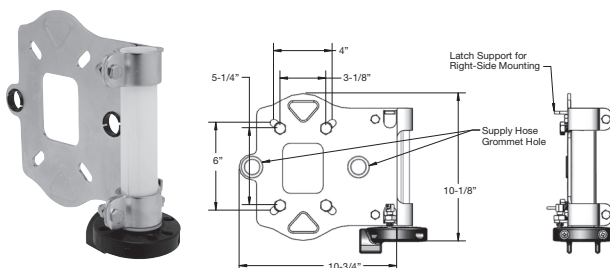

G019430-45

EasyInstall Universal Stainless Steel Bracket (-ESB)

- 100° rotation stainless steel swing bracket
- Fits all T&S 3/8" and 1/2" hose reels
- Add "-ESB" suffix to model number to specify this bracket (see page E14 for configurator)



EasyInstall

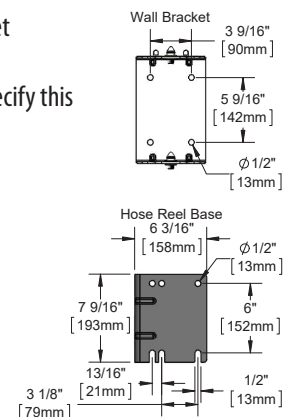

Open and Enclosed Hose Reels – Specifications

E
14



These configurators and charts show you how to custom order a hose reel according to its application.

Note: Not all combinations are available. Check with T&S Customer Service for more information.

Model B-7000 Series OPEN Hose Reels

B - 7 - - - -

Reel Material

- 1 = Stainless Steel
- 2 = Epoxy-Coated Steel

Note: Same for EB-models

Hose Length

- 0 = 12'
- 1 = 15'
- 3 = 35'
- 4 = 50'

Diameter

- 2 = 3/8"
- 3 = 1/2"
- 5 = 3/4"

(See Spray Valves and Water Guns chart, right)

(See Mounting Brackets chart, below, right)

For example: B-7132-01-ESB = Stainless steel open hose reel, 35' hose with 3/8" diameter, EB-0107 High-Flow Blue Spray Valve and EasyInstall 100° Universal Stainless Steel Swing Bracket

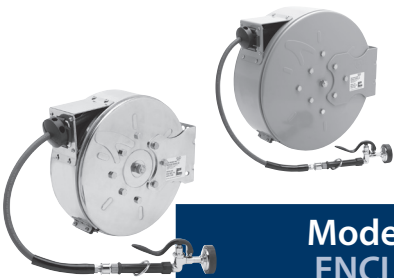

Model B-7000-C Series ENCLOSED Hose Reels

B - 7 - - - -

Reel Material

- 1 = Stainless Steel
- 2 = Epoxy-Coated Steel

Note: Same for EB-models

Hose Length

- 2 = 30'
- 4 = 50'

Diameter

- 2 = 3/8"

(See Spray Valves and Water Guns chart, above)

(See Mounting Brackets chart, right)

For example: B-7222-C01-ESB = Epoxy-coated steel enclosed hose reel, 30' hose with 3/8" diameter, EB-0107 High-Flow Spray Valve and EasyInstall 100° Universal Stainless Steel Swing Bracket

Spray Valves and Water Guns

Suffix

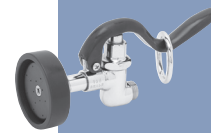

EB-0107
High-Flow
Spray Valve

-01

B-0107
Spray Valve

-01M



MV-2516-24
5/16" dia. flow Rear
Trigger Water Gun

-02

MV-2516-34
7/16" dia. flow Rear
Trigger Water Gun

-03

MV-2516-44
9/16" dia. flow Rear
Trigger Water Gun

-04

1/2" FE Inlet Thread



MV-2522-24
5/16" dia. flow Front
Trigger Water Gun

-05

MV-2522-34
7/16" dia. flow Front
Trigger Water Gun

-06

MV-2522-44
9/16" dia. flow Front
Trigger Water Gun

-07

1/2" FE Inlet Thread

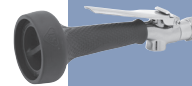

B-0108-H
High-Flow
JeTSpray Valve

-08H

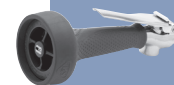

B-0108
JeTSpray Valve

-08M



EB-2322
Extended Spray Wand

-10



MV-3516-24
5/16" dia. flow
Aluminum Rear
Trigger Water Gun

-11

1/2" FE Inlet Thread

Mounting Brackets (see p. E13)

G016652-45

Epoxy Coated Steel Pivot Bracket -PPB

G018477-45

Stainless Steel Table Leg
Swing Bracket

-STB

G019430-45

EasyInstall 100° Universal Hose
Reel Stainless Steel Swing Bracket -ESB



Hose Reels with Spray Valve and Water Gun Options

Spray Valve / Water Gun Options

- Flow rates at 60 PSI
- Find additional information about our hose reel models, spray valves and water guns in this Washdown section.

Hose Reel Options

	EB-0107 -01 suffix	B-0107 -01M suffix	MV-2516-24 -02 suffix	MV-2516-34 -03 suffix	MV-2916-44 -04 suffix	MV-2522-24 -05 suffix	MV-2922-34 -06 suffix	MV-2522-44 -07 suffix	B-0108-H -08H suffix	B-0108 -08M suffix	EB-2922 -10 suffix	MV-3516-24 -11 suffix
STAINLESS STEEL												
B-7102 SERIES Open 3/8" x 12'	B-7102-01 3.5 GPM 13.25 LPM	B-7102-01M 1.42 GPM 5.38 LPM										
B-7112 SERIES Open 3/8" x 15'	B-7112-01 3.7 GPM 14 LPM	B-7112-01M 1.42 GPM 5.38 LPM	B-7112-02 4.8 GPM 18.17 LPM			B-7112-05 4.8 GPM 18.17 LPM			B-7112-08H 3.6 GPM 13.63 LPM	B-7112-08M 1.48 GPM 5.6 LPM	B-7112-10 4.2 GPM 15.9 LPM	
B-7122-C SERIES Enclosed 3/8" x 30'	B-7122-C01 3.5 GPM 13.5 LPM	B-7122-C01M 1.42 GPM 5.38 LPM	B-7122-C02 4.3 GPM 16.28 LPM			B-7122-C05 4.3 GPM 16.28 LPM			B-7122-C08H 3.3 GPM 12.49 LPM	B-7122-C08M 1.48 GPM 5.6 LPM	B-7122-C10 3.9 GPM 14.76 LPM	
B-7132 SERIES Open 3/8" x 35'	B-7132-01 3.4 GPM 12.87 LPM	B-7132-01M 1.42 GPM 5.38 LPM	B-7132-02 4.1 GPM 15.52 LPM			B-7132-05 4.1 GPM 15.52 LPM			B-7132-08H 3.2 GPM 12.11 LPM	B-7132-08M 1.48 GPM 5.6 LPM	B-7132-10 3.6 GPM 13.63 LPM	
B-7133 SERIES Open 1/2" x 35'	B-7133-01 4.94 GPM 18.70 LPM		B-7133-02 5.20 GPM 19.68 LPM	B-7133-03 8.09 GPM 30.62 LPM	B-7133-04 7.68 GPM 29.07 LPM	B-7133-05 5.20 GPM 19.68 LPM	B-7133-06 8.09 GPM 30.62 LPM	B-7133-07 7.68 GPM 29.07 LPM				
B-7142 SERIES Open 3/8" x 50'	B-7142-01 3.2 GPM 12.11 LPM	B-7142-01M 1.42 GPM 5.38 LPM	B-7142-02 3.7 GPM 14 LPM			B-7142-05 3.7 GPM 14 LPM			B-7142-08H 3.0 GPM 11.36 LPM	B-7142-08M 1.48 GPM 5.6 LPM	B-7142-10 3.4 GPM 12.87 LPM	
B-7142-C SERIES Enclosed 3/8" x 50'	B-7142-C01 3.2 GPM 12.11 LPM	B-7142-C01M 1.42 GPM 5.38 LPM	B-7142-C02 3.7 GPM 14 LPM			B-7142-C05 3.7 GPM 14 LPM			B-7142-C08H 3.0 GPM 11.36 LPM	B-7142-C08M 1.48 GPM 5.6 LPM	B-7142-C10 3.4 GPM 12.87 LPM	
B-7143 SERIES Open 1/2" x 50'	B-7143-01 4.56 GPM 17.26 LPM		B-7143-02 5.01 GPM 18.96 LPM	B-7143-03 7.42 GPM 28.09 LPM	B-7143-04 6.84 GPM 25.89 LPM	B-7143-05 5.01 GPM 18.96 LPM	B-7143-06 7.42 GPM 28.09 LPM	B-7143-07 6.84 GPM 25.89 LPM				
PAINTED STEEL												
B-7212 SERIES Open 3/8" x 15'	B-7212-01 3.7 GPM 14 LPM	B-7212-01M 1.42 GPM 5.38 LPM	B-7212-02 4.8 GPM 18.17 LPM			B-7212-05 4.8 GPM 18.17 LPM			B-7212-08H 3.0 GPM 11.36 LPM	B-7212-08M 1.48 GPM 5.6 LPM	B-7212-10 4.2 GPM 15.9 LPM	B-7212-11 4.7 GPM 17.79 LPM
B-7222-C SERIES Enclosed 3/8" x 30'	B-7222-C01 3.5 GPM 13.5 LPM	B-7222-C01M 1.42 GPM 5.38 LPM	B-7222-C02 4.3 GPM 16.28 LPM			B-7222-C05 4.3 GPM 16.28 LPM			B-7222-C08H 3.3 GPM 12.49 LPM	B-7222-C08M 1.48 GPM 5.6 LPM	B-7222-C10 3.9 GPM 14.76 LPM	B-7222-C11 4.2 GPM 15.9 LPM
B-7232 SERIES Open 3/8" x 35'	B-7232-01 3.4 GPM 12.87 LPM	B-7232-01M 1.42 GPM 5.38 LPM	B-7232-02 4.1 GPM 15.52 LPM			B-7232-05 4.1 GPM 15.52 LPM			B-7232-08H 3.2 GPM 12.11 LPM	B-7232-08M 1.48 GPM 5.6 LPM	B-7232-10 3.6 GPM 13.63 LPM	B-7232-11 4.2 GPM 15.9 LPM
B-7242 SERIES Open 3/8" x 50'	B-7242-01 3.2 GPM 12.11 LPM	B-7242-01M 1.42 GPM 5.38 LPM	B-7242-02 3.7 GPM 14 LPM			B-7242-05 3.7 GPM 14 LPM			B-7242-08H 3.0 GPM 11.36 LPM	B-7242-08M 1.48 GPM 5.6 LPM	B-7242-10 3.4 GPM 12.87 LPM	
B-7242-C SERIES Enclosed 3/8" x 50'	B-7242-C01 3.2 GPM 12.11 LPM	B-7242-C01M 1.42 GPM 5.38 LPM	B-7242-C02 3.7 GPM 14 LPM			B-7242-C05 3.7 GPM 14 LPM			B-7242-C08H 3.0 GPM 11.36 LPM	B-7242-C08M 1.48 GPM 5.6 LPM	B-7242-10 3.4 GPM 12.87 LPM	
B-7245 SERIES Open 3/8" x 50'			B-7245-03 11.0 GPM 41.64 LPM	B-7245-04 11.0 GPM 41.64 LPM		B-7245-05 10.9 GPM 41.26 LPM	B-7245-06 10.9 GPM 41.26 LPM	B-7245-07 10.9 GPM 41.26 LPM				

The options shown here represent the entire T&S hose reel line, but please note that not all combinations are available. This chart outlines the combinations we currently offer.

Complete Hose Reel Assemblies

B-1430 Enclosed 30' Hose Reel Assembly

- All-in-one system with exposed piping and accessories
- Enclosed hose reel (B-7222-C01) with EB-0107 blue high-flow spray valve
- Continuous pressure vacuum breaker (B-0963)
- Shut-off control valve (ORK3)
- Angled slip flange
- 3" C/C concealed mixing faucet (B-0513)
- 36" (922 mm) flexible connecting hose with quick-disconnect
- Shipped with all components needed for installation
- Wall bracket (B-0109-07)

B-1432 Enclosed 30' Hose Reel Assembly

- All-in-one system with exposed piping and accessories
- Enclosed hose reel (B-7222-C01) with EB-0107 blue high-flow spray valve
- Continuous pressure vacuum breaker (B-0963)
- Shut-off control valve (ORK2)
- 2-3/8" (60 mm) dia. wall flange
- 3" C/C concealed mixing faucet (B-0513)
- Wall bracket (B-0109-07)
- 36" (922 mm) flexible connecting hose with quick-disconnect
- Shipped with all components needed for installation

B-7222-C01XS1E Enclosed 30' Hose Reel Assembly

- All-in-one system with exposed piping and accessories
- Enclosed hose reel (B-7222-C01) with EB-0107 blue high-flow spray valve
- Continuous pressure vacuum breaker (B-0963)
- Shut-off control valve (ORK3)
- 8" wall mount mixing faucet (B-0330-LN) with Eterna cartridges with spring checks
- Two (2) wall brackets (B-0109-07)
- 36" (922 mm) flexible connecting hose with quick-disconnects
- Shipped with all components needed for installation

- **B-7232-U01XS1E** Same as B-7222-C01XS1E except w/ B-7232-01 open hose reel
- **B-1433-04** Same as B-7222-C01XS1E except with front trigger water gun
- **B-1433-7132-01M** Same as B-7222-C01XS1E except with open stainless steel hose reel with 35' hose (B-7132-01M) and B-0107 spray valve
- **B-1433-01M-QDS** Same as B-7222-C01XS1E except with 35' open painted steel hose reel (B-7232); includes two (2) quick-disconnect spray valves (B-0107-QD and EB-2322-QD)
- **B-1433-CR** Same as B-7222-C01XS1E except with Cerama cartridges with check valves
- **B-1433-CR-QDS** Same as B-1433-01M-QDS except with Cerama cartridges with check valves
- **B-1434-RG** All-in-one system with exposed piping and accessories; includes B-7142-01 hose reel, 8" wall-mount mixing faucet, shut-off valve (ORK3), vacuum breaker (B-0963), flexible connecting hose and EB-0107 high-flow spray valve

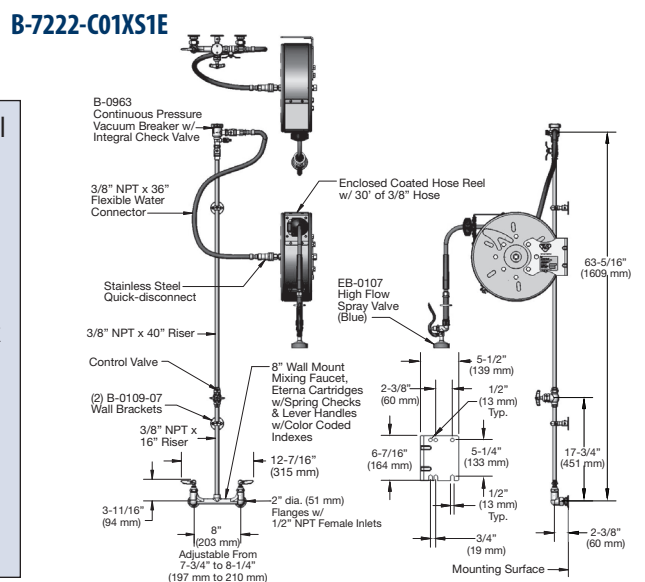
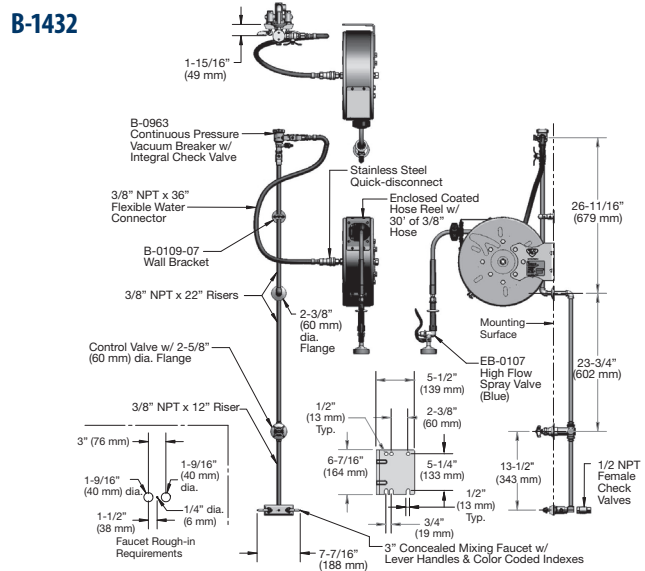
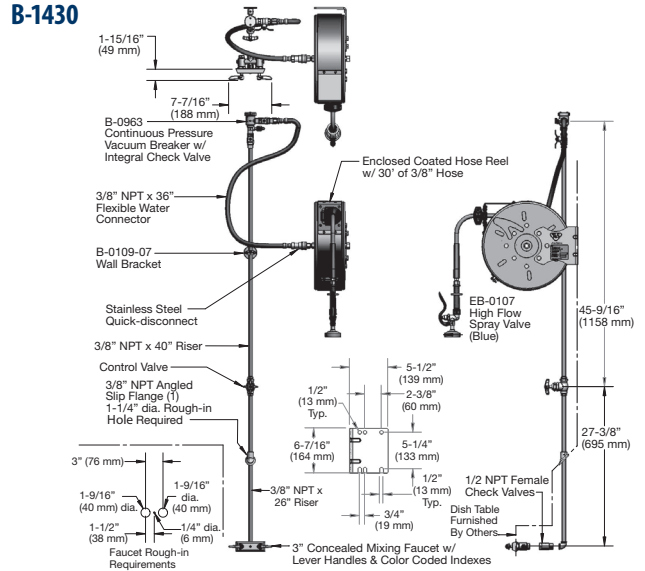

Complete Hose Reel Assemblies

B-1436 Open 35' Stainless Steel Hose Reel Assembly with Backplate

- All-in-one, convenient-to-install complete hose reel assembly
- Open hose reel (B-7132-01) with blue high-flow spray valve (EB-0107)
- Continuous pressure vacuum breaker (B-0963)
- Shut-off control valve (ORK3)
- 8" deck-mount mixing faucet (B-0320-LN) with Eterna cartridges with spring checks
- Stainless steel backplate
- Arrives completely assembled for easy installation

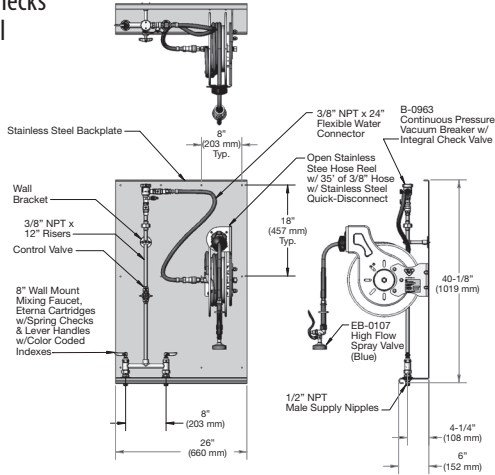

B-1444 Enclosed Stainless Steel Hose Reel Assembly with 50' Hose

- All-in-one system with exposed piping and accessories
- Enclosed stainless steel hose reel (B-7142-C01) with 50' hose and EB-0107 blue high-flow spray valve
- Continuous pressure vacuum breaker (B-0963)
- Two (2) wall brackets (B-0109-07)
- Shut-off control valve (ORK3)
- 8" wall-mount mixing faucet (B-0330-LN) with Eterna cartridges with spring checks
- Includes 36" (922 mm) flexible connecting hose assembly
- Shipped with all components needed for installation

B-1444-CV Same as B-1444 except with two B-CVH1-2 check valves

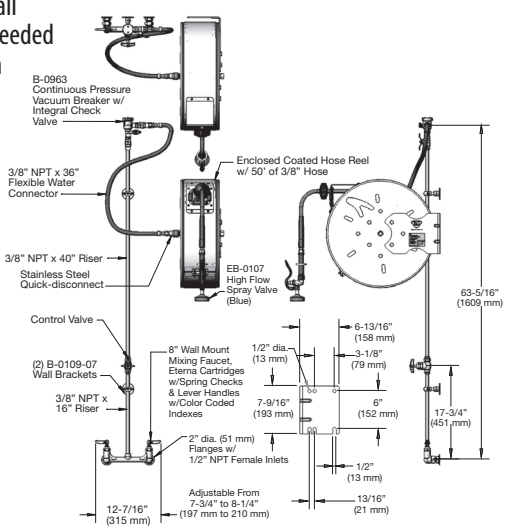

B-1439 Open Stainless Steel Hose Reel Assembly with 50' Hose

- All-in-one system with exposed piping and accessories
- Open stainless steel hose reel (B-7142-05) with MV-2522-24 blue water gun
- Continuous pressure vacuum breaker (B-0963)
- Two (2) wall brackets (B-0109-07)
- Shut-off control valve (ORK3)
- 8" wall-mount mixing faucet (B-0330-LN) with Eterna cartridges with spring checks
- Includes 36" (922 mm) flexible connecting hose assembly
- Shipped with all components needed for installation

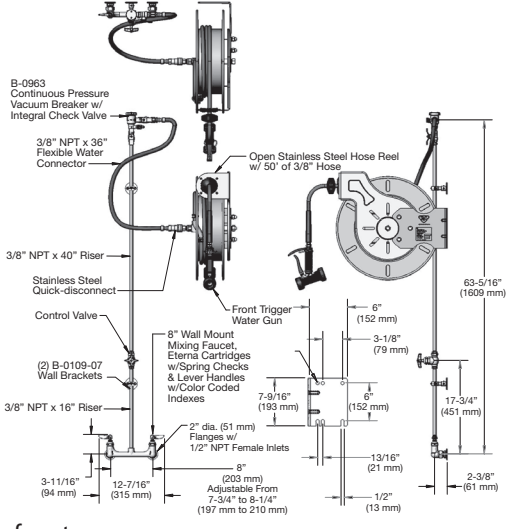

B-1453 Open Epoxy-Coated Steel Hose Reel Assembly with 35' Hose

- All-in-one system with exposed piping and accessories
- Open hose reel (B-7232-05) with 35' hose and MV-2522-24 blue front trigger water gun
- Shut-off control valve (ORK3)
- B-1035 concealed mixing valve with 1/2" NPT female inlets
- 3/8" NPT x 40" riser
- B-0963 continuous pressure vacuum breaker with integral check valve
- Two (2) check valves (B-CVH1-2)
- Two (2) wall brackets (B-0109-07)
- Shipped with all components needed for installation

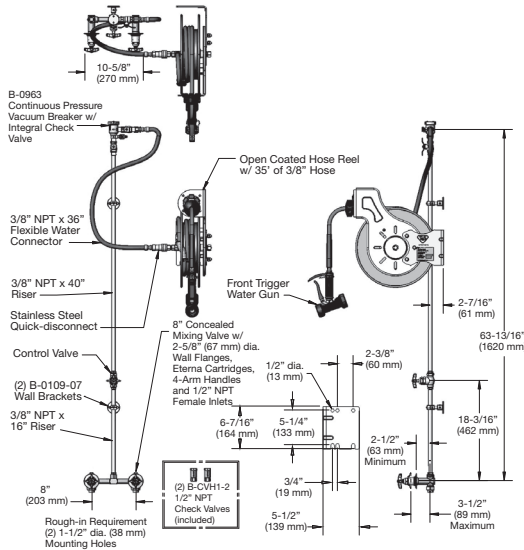

Complete Hose Reel Assemblies

B-1457 Enclosed Epoxy-Coated Steel Hose Reel Assembly with 30' Hose

- All-in-one system with exposed piping and accessories
- Enclosed hose reel with 30' hose (B-7222-C01M)
- 1.15 GPM spray valve (B-0107)
- Continuous pressure vacuum breaker (B-0963)
- Single hole deck-mount faucet with spring checks and lever handles with color coded indexes (B-0300-LN)
- 18" flexible stainless steel supply hoses
- Shut-off control valve (ORK3)
- Two (2) wall brackets (B-0109-07)
- 3/8" NPT x 36" flexible water connector to hose reel (HW-4B-36)
- Shipped with all components needed for installation

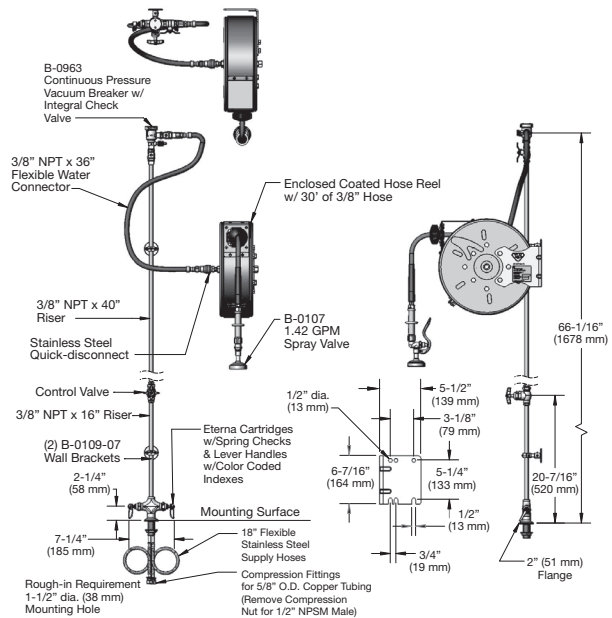

B-1458 Enclosed Stainless Steel Hose Reel Assembly with 30' Hose

- All-in-one system with exposed piping and accessories
- Enclosed stainless steel hose reel with 30' hose (B-7122-C01)
- 1.15 GPM spray valve (B-0107)
- Continuous pressure vacuum breaker (B-0963)
- 8" wall-mount faucet with spring checks (B-0330-LN)
- Shut-off control valve in riser (ORK3)
- Two (2) wall brackets (B-0109-07)
- Flexible water connector to hose reel (HW-4B-36)
- Two (2) check valves (B-CVH1-2)
- Shipped with all components needed for installation

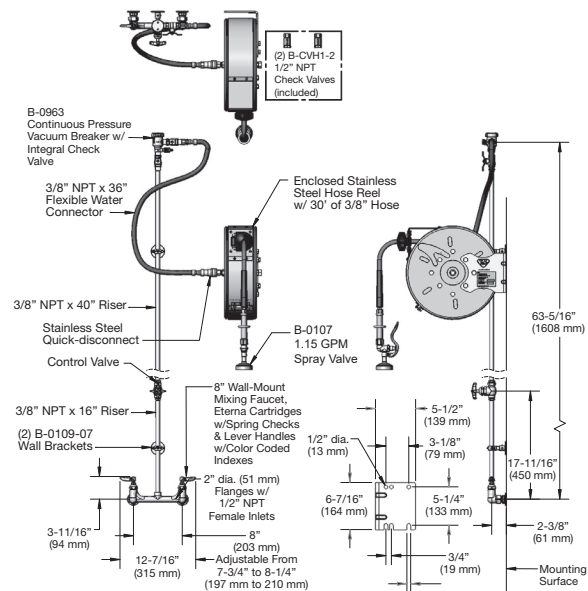

B-1459 Enclosed Stainless Steel Hose Reel Assembly with 30' Hose

- All-in-one system with exposed piping and accessories
- Enclosed stainless steel hose reel with 30' hose (B-7122-C01)
- Blue high-flow spray valve (EB-0107)
- Continuous pressure vacuum breaker (B-0963)
- 3" concealed mixing faucet (B-0512)
- 6" wall bracket (B-0109-01)
- Flexible water connector to hose reel (HW-4B-36)
- Two (2) check valves (B-CVH1-2)
- Installer required materials for in-wall installation

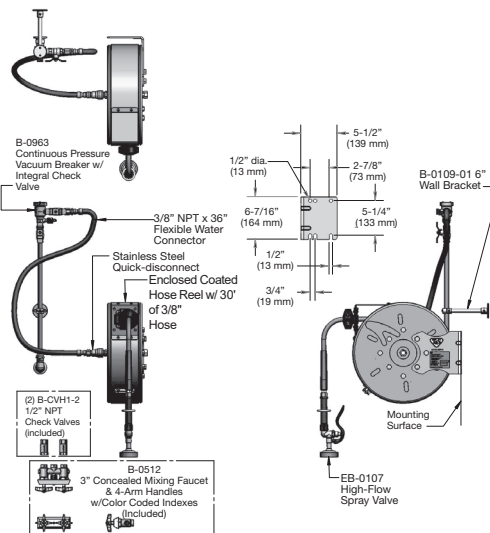

Complete Hose Reel Assemblies

B-1454 Open Epoxy-Coated Steel Hose Reel Assembly with 35' Hose

- All-in-one system with exposed piping and accessories
- Open hose reel (B-7232-05) with 35' hose and MV-2522 blue front trigger water gun
- Shut-off control valve (ORK3)
- 8" wall-mount service sink faucet (B-0674-BSTP)
- 8" concealed mixing valve with 1/2" NPT female inlets (B-1035)
- 3/8" NPT x 40" riser
- B-0963 continuous pressure type vacuum breaker
- Two (2) inline check valves included (B-CVH1-2)
- Two (2) B-0109-07 wall brackets
- Shipped with all components needed for installation

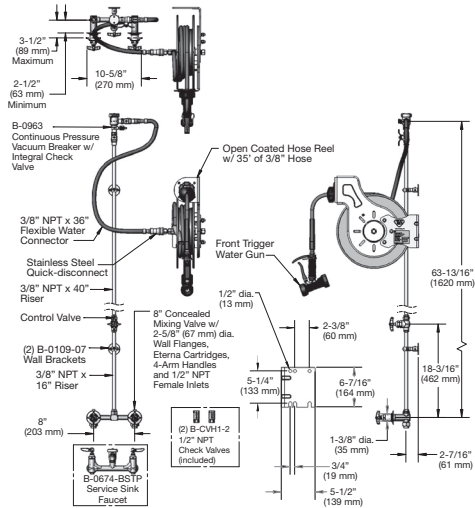

B-1459-7132-01 Open Stainless Steel Hose Reel Assembly with 35' Hose

- All-in-one system with exposed piping and accessories
- Open stainless steel hose reel (B-7132-01) with 35' hose and EB-0107 High-flow spray valve
- 3/8" NPT x 36" flexible water hose with quick-disconnect (HW-2B-36)
- 3" C/C concealed mixing faucet (B-0512) with (2) 1/2" check valves
- 3/8" NPT x 18" riser
- B-0963 continuous pressure type vacuum breaker with integral check valves included
- (1) B-0109-01 wall bracket
- Installer required materials for in-wall installation

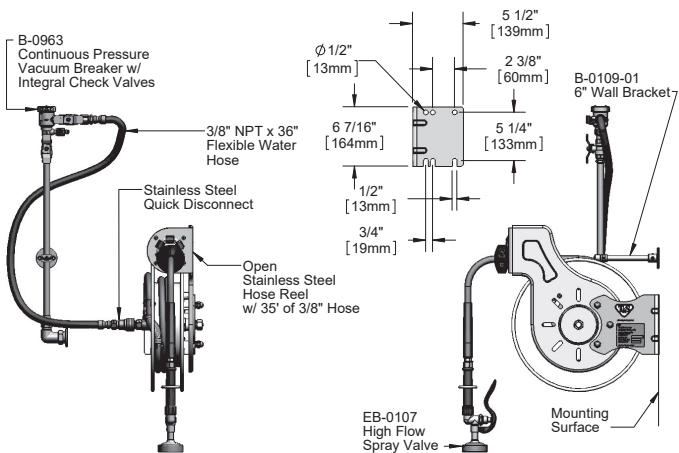

B-1480 Open Stainless Steel Hose Reel Assembly with 50' Hose

- All-in-one system with exposed piping and accessories
- Open 1/2" hose reel (B-7143-05) with 50' hose and MV-2522-24 front trigger water gun
- Shut-off control valve, polished chrome (002900-40)
- 8" wall-mount mixing faucet (013988-40)
- 1/2" NPT x 32" riser
- B-0963 continuous pressure type vacuum breaker
- Two (2) inline check valves included (B-CVH1-2)
- Two (2) B-0110 wall brackets
- Shipped with all components needed for installation

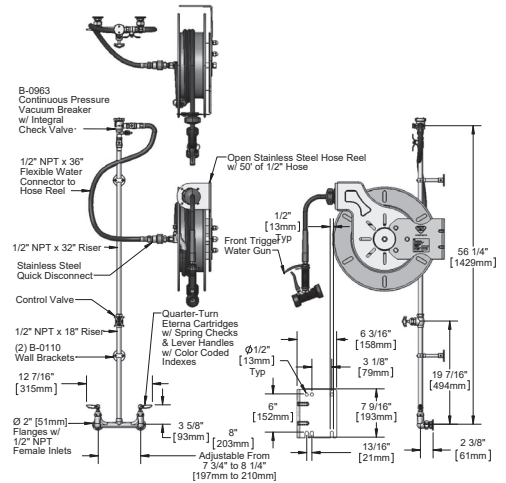

B-1459-7142-01 Open Stainless Steel Hose Reel Assembly with 50' Hose

- All-in-one system with exposed piping and accessories
- Open stainless steel hose reel (B-7143-05) with 50' hose and EB-0107 High-flow spray valve
- 3/8" NPT x 36" flexible water hose with quick-disconnect (HW-2B-36)
- 3" C/C concealed mixing faucet (B-0512) with (2) 1/2" check valves
- 3/8" NPT x 18" riser
- B-0963 continuous pressure type vacuum breaker with integral check valves included
- (1) B-0109-01 wall bracket
- Installer required materials for in-wall installation

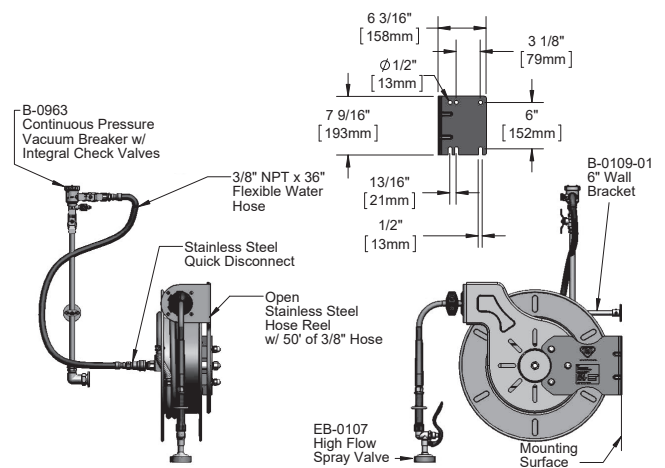

Complete Hose Reel Assemblies

E
20

Suggested Configuration for T&S Hose Reels and Accessories

This illustration is a suggested hose reel configuration using T&S Hose Reel Accessories shown on pages E14 and E121-23. These accessories allow you to design a hose reel assembly to meet any of your requirements.

All T&S accessories are made to our high-quality standards for ease of installation, minimum maintenance and long life. Order each part separately by the part number shown.

Note: The B-1433 is used here as an example; other models will vary slightly in their specifications.

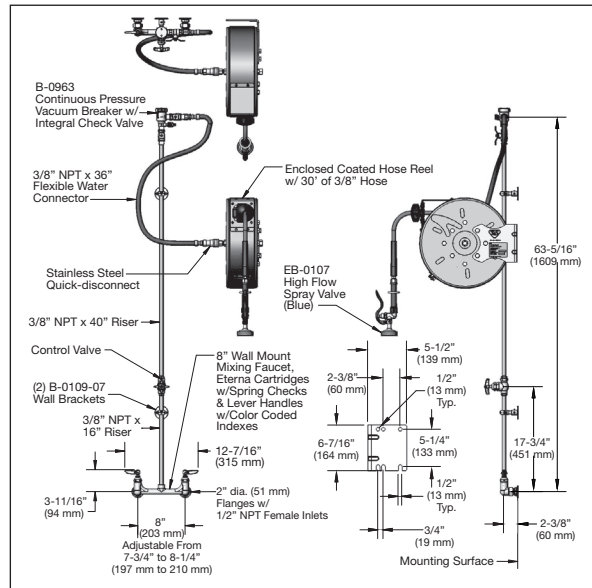

All-In-One Hose Reel Assemblies with Control Cabinet

B-2339 Control Unit and Hose Reel Assembly with 30' Hose

- Enclosed hose reel with 30' hose and EB-0107 high flow spray valve (B-7222-C01)
- Stainless steel control cabinet which includes all components – gauges, vacuum breaker, thermometer, water hammer arrestor and check valves
- Hose reel can be mounted on ceiling, wall or under the counter
- Allows total tamper-resistant control, convenient and compact
- 1/2" NPT female inlets to control cabinet



B-2339-02 Same as B-2339 except with MV-2522-24 water gun with riser, B-0963 vacuum breaker and 24" flexible water connector (HW-4B-24)

B-2339-7132MVBH Same as B-2339 except with B-0107 spray valve, B-7132-01M hose reel, B-0963 vacuum breaker and 24" flexible water connector (HW-4B-24)

B-2339-LR Same as B-2339 except with only control unit, without B-7222-C01. Can be used with any T&S hose reel

B-2339-7122C01J Control Unit and Hose Reel Assembly with 30' Hose

- B-7122-C01 enclosed hose reel with 30' hose
- B-0107-J spray valve with swivel with 360° swivel
- Stainless steel control cabinet which includes all components – gauges, vacuum breaker, thermometer, water hammer arrestor and check valves
- Hose reel can be mounted on ceiling, wall or under the counter
- Allows total tamper-resistant control, convenient and compact
- 1/2" NPT female inlets to control cabinet

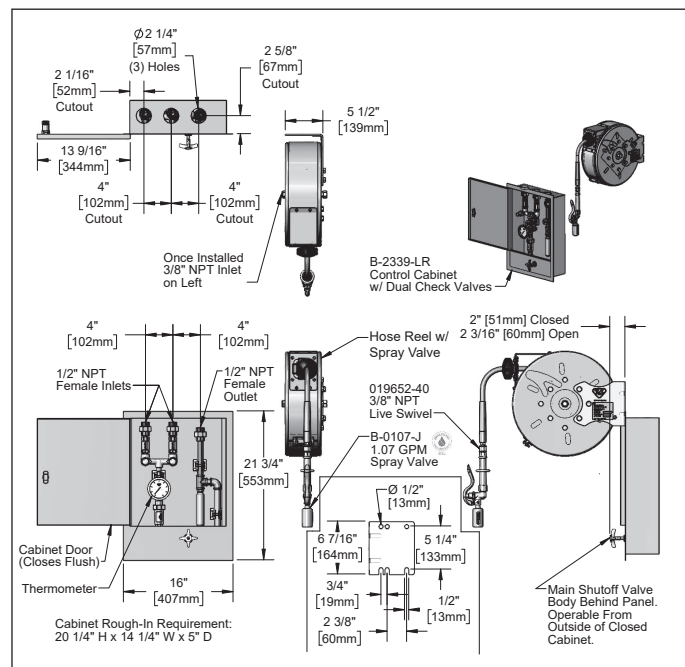

Heavy-Duty Water Guns

T&S heavy-duty water guns are designed for washdown stations and general sanitizing operations in a broad variety of commercial and institutional applications.

MV-2516 Series Rear Trigger Water Guns

- Heavy-duty stainless steel construction, designed for long life
- Adjustable stream from solid to soft spray
- Excellent for cleaning jobs
- Controls water supply easily and efficiently
- 1/2" NPT female inlet
- Automatic shut-off conserves water
- Rated up to 125 psi
- Blue rubber cover



MV-2522 Series Front Trigger Water Guns

- Heavy-duty stainless steel construction, designed for long life
- Adjustable stream from solid to soft spray
- Excellent for cleaning jobs
- Controls water supply easily and efficiently
- 1/2" NPT female inlet
- Automatic shut-off conserves water
- Rated up to 125 psi
- Blue rubber cover



T&S Water Gun Replacement Parts:

- 014087-45 5/16" and 7/16" Orifice, Rear Trigger Cartridge Assembly
- 014086-45 5/16" and 7/16" Orifice, Front Trigger Cartridge Assembly
- 014187-45 Blue Rubber Cover (used on both style guns)

MV-3516-25 Aluminum Rear Trigger Water Gun

- Lightweight aluminum water gun with 5/16" flow orifice
- Blue rubber cover
- Includes 1/2" NPT male x 3/8" NPT female adapter (not shown)
- 1/2" NPT female inlet
- Variable spray patterns
- Drip-free automatic shut-off



MV-3516 Models and Kit:

MV-3516-21	1/2 NPT x 1/2" hose barb
MV-3516-22	1/2 NPT x 3/4" hose barb
MV-3516-24	1/2 NPT female inlet

EB-2322 Spray Valve, Extension Unit

- Spray valve (EB-0107) with self-closing squeeze valve and extension for 21-3/4" (552 mm) total length
- 3/8" NPT female inlet
- Blue grip handle with hold-down ring
- Removable spray head



Caution: these Water Guns are not designed for use on steam lines

B-2516 Series Rear Trigger Water Guns

Model: MV-2516-_____

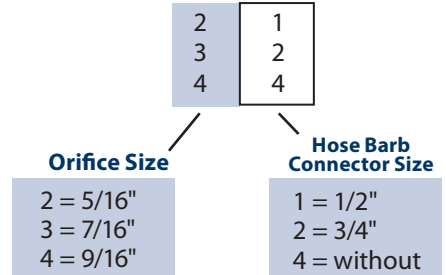

Model	Orifice Size	Hose Barb Connector Size
MV-2516-		
-21	5/16"	1/2"
-22	5/16"	3/4"
-24	5/16"	without
-31	7/16"	1/2"
-32	7/16"	3/4"
-34	7/16"	without
-41	9/16"	1/2"
-42	9/16"	3/4"
-44	9/16"	without

B-2522 Series Front Trigger Water Guns

Model: MV-2522-_____

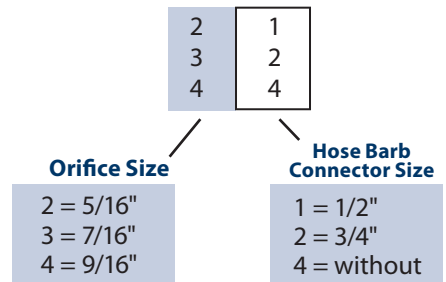

Model	Orifice Size	Hose Barb Connector Size
MV-2522-		
-21	5/16"	1/2"
-22	5/16"	3/4"
-24	5/16"	without
-31	7/16"	1/2"
-32	7/16"	3/4"
-34	7/16"	without
-41	9/16"	1/2"
-42	9/16"	3/4"
-44	9/16"	without

Heavy-Duty Spray Valves and Water Guns – Spray Pattern

E
22

EB-0107 High Flow Spray Valve



B-0108-H High Flow JeTSpray Valve



MV-2516 Rear Trigger Water Gun



EB-2322 Spray Valve Extension Unit



MV-2522 Front Trigger Water Gun



MV-3516-25 Aluminum Rear Trigger Water Gun



Spray Valves

B-0107 Spray Valve

- 1.15 GPM at 60 PSI
- Connects directly to hose grip handles
- Designed for heavy use in industrial kitchens
- Shuts off when handle is released
- Add "-01M" suffix to hose reel model to specify this spray valve



B-0108 JeTSpray Valve

- Ergonomically designed spray valve for hose reels
- 1.07 GPM at 60 PSI
- Requires 016154-25 (3/8") or 016157-25 (1/2") adapter to connect to hose reel hose (sold separately)
- Designed for heavy use in kitchens
- Shuts off when handle is released
- Add "-08M" suffix to hose reel model to specify this spray valve



EB-0107 High Flow Spray Valve

- Blue spray valve
- Connects directly to hose grip handles
- Designed for heavy use in industrial kitchen settings
- Shuts off when handle is released
- Add "-01" suffix to hose reel model to specify this spray valve



B-0108-H JeTSpray High Flow Spray Valve

- Ergonomically designed spray valve for hose reels
- Connects directly to T&S hose reel hose
- Designed for heavy use in industrial settings
- Shuts off when handle is released
- Add "-08H" suffix to hose reel model to specify this spray valve



Vacuum Breaker

B-0963 Continuous Pressure Vacuum Breaker Assembly

- Designed for continuous pressure
- Furnished with quarter-turn ball valves
- 1/2" NPT female inlet and outlet
- 001359-40 adapters available for 3/8" NPT female connections
- ASSE 1056
- Order a B-0963-RK repair kit:

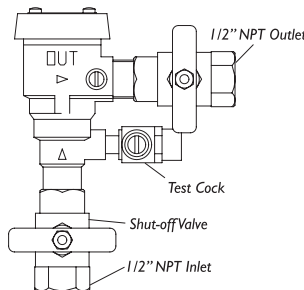

B-0963-RK



Hose Reel Swivel Connector Kits

019561-45 Swivel Kit, 3/8" NPT x 50'

- Swivel connector kit for 3/8" NPT x 50' hose reel

014946-45 Swivel Kit, 3/8"

- Swivel connector kit for 3/8" NPT x 12', 30' and 35' hose reel

014947-45 Swivel Kit, 1/2"

- Swivel connector kit for 1/2" NPT x 50' hose reel

Hose Reel O-Ring Parts Kits

014948-45 O-Ring Kit, 3/8"

- O-Ring kit for 3/8" x 12', 30' and 35' hose reels

019473-45 O-Ring Kit, 1/2"

- O-Ring kit for 1/2" hose reels and 3/8" x 50' hose reels

Hose Reel Kits / Replacement Parts

Swivel Kits

Part Number	Hose I.D.	Hose Length
014946-45	3/8"	15' / 30' / 35' / 50'
017355-45	3/8"	12'
017362-45	3/8"	12'
014947-45	1/2"	35' / 50'
019561-45	3/8"	50'

Spring Assemblies

Part Number	Hose I.D.	Hose Length
014932-45	3/8"	15' / 30' / 35'
014934-45	3/8" and 1/2"	35' (1/2" only) / 50'

Stainless Reels

014933-45	3/8" and 1/2"	15' / 30' / 35'
014935-45	3/8" and 1/2"	50'

Hose Stop Kits

Part Number	Hose I.D.	Hose Length
014949-45	3/8"	15' / 30' / 35' / 50'
G016590-45	3/8"	12'
019499-45	1/2"	35' / 50'

Ratchet Kit

Part Number	Hose I.D.	Hose Length
014940-45	3/8" and 1/2"	15' / 30' / 35' / 50'
017359-45	3/8"	12'

Roller Kits

Part Number	Hose I.D.	Hose Length
014938-45	3/8" and 1/2"	15' / 35' / 50'
Enclosed Small		
014936-45	3/8"	30'
Enclosed Large		
014937-45	3/8" and 1/2"	50'
017352-45	3/8"	12'

Hose Kits

Part Number	Hose I.D.	Hose Length	PSI
014944-45	3/8"	15'	300
014943-45	3/8"	30'	300
014941-45	3/8"	35'	300
014942-45	3/8"	50'	300
017938-45	3/8"	12'	300
014945-45	1/2"	50'	300
015089-45	1/2"	35'	300

Swivel 'O'-Ring Kit

Part Number	Hose I.D.	Hose Length
014948-45	3/8"	12' / 15' / 30' / 35'
019473-45	1/2"	50'

Other Parts and Kits

045A Reel Hose Repair Kit

- Field repair kit for 3/8" hose and fitting
- Includes coupling and nipple insert



B-CVV1-2 Check Valve

- 1/2" vertical check valve
- Rough brass finish
- 1/2" NPT female inlet and outlet
- Designed for water use only



Check Valves

B-CVH1-2 for horizontal or vertical use, 1/2" NPT female
 B-CVH3-4 for horizontal or vertical use, 3/4" NPT female
 Furnished in rough brass

B-0273-QD Washdown Quick-Disconnect

- Washdown quick-disconnect assembly
- Chrome plated
- Not rated for potable/drinking water

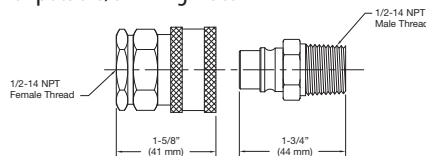

ORK-SK Hose Reel Connector Kit

- Kit includes (1) each:
- 1/2" NPT inlet elbow
 - 3/8" NPT x 18" riser
 - B-0963 continuous pressure vacuum breaker
 - 3/8" NPT x 36" flexible water connector
 - Quick-disconnect

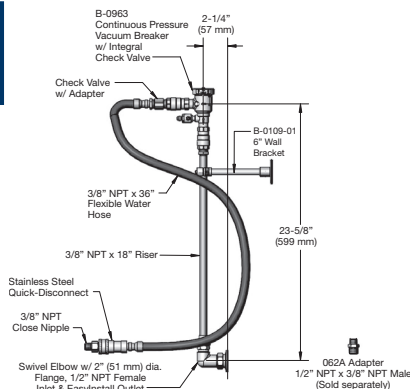

Shut-Off Valves and Mixing/Control Valves

B-0512 Shut Off Control Valve



- Wall-mount
- 3/8" NPT inlets and outlet
- 3" C/C
- Eterna cartridges with color coded indexes
- 4-arm handles

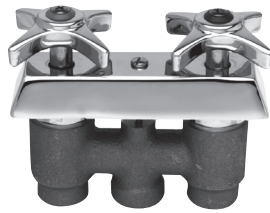

B-0513 Same as B-0512 except with lever handles

B-1025-ST Concealed Straight Valve



- 1/2" NPT female outlet
- Straight loose key stop with 1/2" NPT female inlet
- Adjustable tear drop escutcheon
- Four-arm handle with blue index
- Eterna cartridge
- Includes T-handle and screw



B-1035-ST Concealed Bypass Mixing Valve



- 8" (203 mm) centers
- Loose key straight stops
- 1/2" NPT female union inlets
- 1/2" NPT female outlet
- Four arm handles
- Adjustable wall flanges
- Eterna cartridges

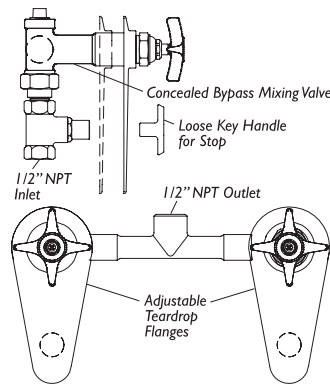

ORK1 Mixing Valve

- Mixing valve with removable seats
- Removable loose key T-handles
- 1/2" NPT female inlets
- 4" (102 mm) centers
- Rough chrome finish
- 3/8" NPT female outlet between valves at opposite side of inlets
- Versatile design for use with vertical pipes (wall) or horizontal piping (ceiling or under sink)



Note: T&S check valves should be installed in lines leading to ORK1 mixing valve

ORK2 Shut Off Control Valve



- Concealed body type
- 3/8" NPT inlet and outlet
- Rough brass body
- Polished chrome plated handle and 2-3/4" dia. adjustable wall flange
- Designed for installation in line between mixing valve and hose reel
- Eterna cartridge
- 4-arm handle with blue index



ORK3 Shut Off Control Valve



- Exposed body type
- 1/2" NPT female inlet and outlet
- Polished chrome plated finish
- Designed for installation on exposed piping between mixing valve and hose reel
- 3/8" NPT female bushings (included)
- Big-Flo spindle assembly
- Removable seat
- 4-arm handle with blue index



Single Temperature Valves and Washdown Stations

E
26

B-0273 Washdown Station



- Big-Flo base faucet
- Furnished with check valves
- 3/4" NPT female eccentric flanged inlets
- Continuous pressure back flow preventer (B-0962)
- 10' creamery hose with quick-disconnect
- Rear trigger water gun (MV-2516-24)
- 4-arm handles with color coded indexes

MV-0771-12C Mixing Valve

- Chrome plated
- 3/4" check valves
- 3/4" unions
- 3/4" globe valves with color coded handles



MV-0771-12R Water Mixing Station

- Hot and cold mixing valve enclosed in galvanized steel recessed cabinet with tamper-resistant screws (bit included) and stainless steel covers
- Inline check valves (B-CVV3-4)
- Mixing valve with 3/4" NPT male inlets
- Hose swivel elbow
- 50' white creamery hose
- Stainless steel rear trigger water gun (MV-2516-44), 9/16" orifice
- Stainless steel hose rack (002970-45)



MV-0771-12R-VB Same as MV-0771-12R except with backflow preventers (B-0962)

MV-0771-12CW Mixing Valve

- MV-0771-12C mixing valve (3/4")
- Stainless steel rear trigger water gun (MV-2516-44)
- Chrome plated brass thermometer tee with hose swivel elbow
- Stainless steel thermometer, temperature range 0°-200° F
- 50 ft. (15.25 m) white creamery hose
- Stainless steel hose rack (002970-45)

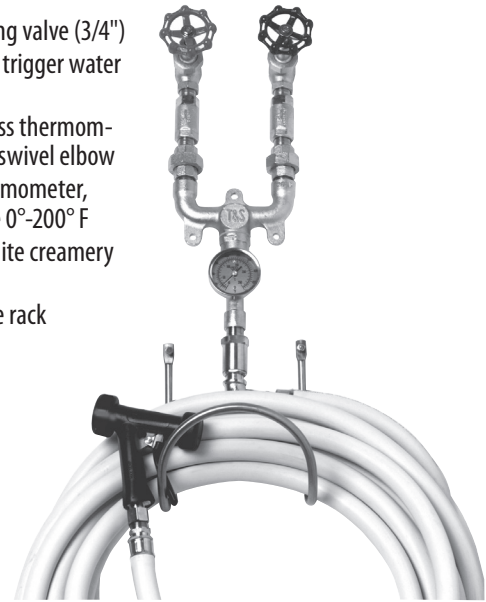

Model No.	Size Valve	Finish
MV-0771-11CW	1/2"	Chrome Plated
MV-0771-11NW	1/2"	Brass
MV-0771-12CW	3/4"	Chrome Plated
MV-0771-12NW	3/4"	Brass

MV-1907-12C Chrome Plated Valve

- 3/4" chrome plated globe valve
- 3/4" NPT x 2-1/2" nipple
- Two B-0159 wall brackets, adjustable from 2-1/8" to 6-11/16" from wall
- Supply piping furnished by others



Model No.	Size Valve
MV-1907-11C	1/2"
MV-1907-12C	3/4"

Single Temperature Valves and Washdown Stations

MV-1907-12CW Single Temperature Valve

- 3/4" ball valve
- Water gun (MV-2516-24)
- 50 ft. (15.2 m) 3/4" white creamery hose
- Chrome plated brass swivel connector for water gun
- Chrome plated brass thermometer tee
- Stainless steel thermometer, temperature range 0°-200° F
- Stainless steel hose rack
- Chrome finish

Model No.	Size Valve
MV-1907-11CW	1/2"
MV-1907-12CW	3/4"

MV-1907-11CW-ER Same as MV-1907-11CW except with 10' hose and MV-2522-24 front trigger water gun



MV-1907-04C Accessory Kit

- Washdown station accessory kit includes:
- (2) Anchor shields
 - (2) Hose rack spacers
 - (2) Hex cap screws
 - (1) Thermometer
 - (1) Stainless steel hose rack
 - (1) 3/4" swivel assembly
 - (1) 50 ft. creamery hose assembly (004980-40)

MV-0771-12N-BVT Washdown Station

- 3/4" NPT natural finish washdown station
- (2) 3/4" ball valves (hot and cold) with stainless steel, color coded handles and nuts
- (2) 3/4" check valves
- Thermometer tee with 3/4" hose swivel elbow
- Stainless steel hose rack with mounting hardware

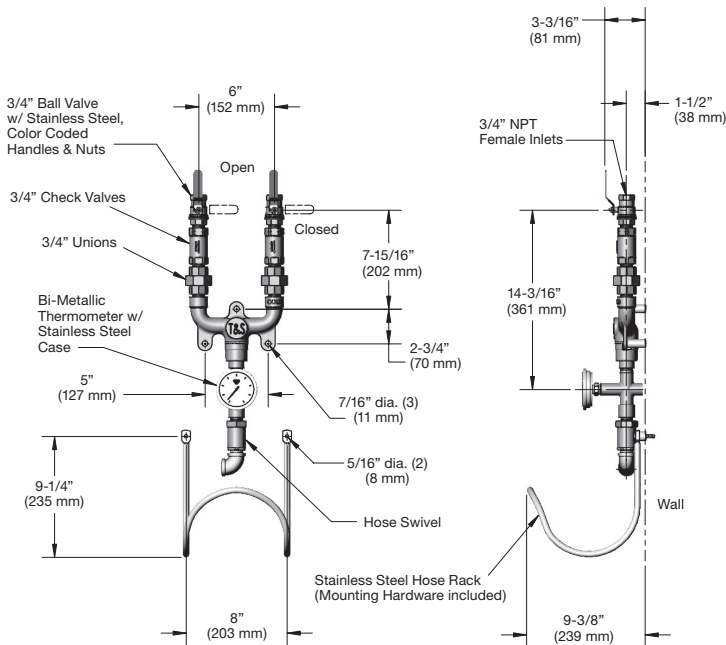

MV-0771-12N-BV Washdown Station

- 3/4" NPT mixing valve
- (2) 3/4" ball valves (hot and cold) with stainless steel, color coded handles and nuts
- (2) 3/4" check valves
- Stainless steel hose rack with mounting hardware
- 3/4" NPT outlet

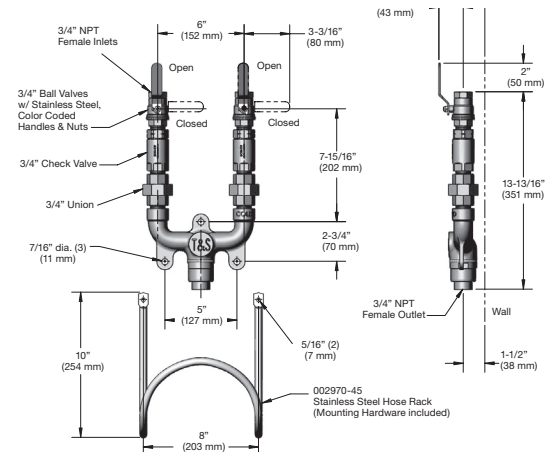

E
28

A series of horizontal blue lines for writing, starting from the top of the page and extending down to the bottom.



RELIABILITY BUILT IN™

G-12

F *Safe-T-Link Appliance
Connectors*



G-12 General Product Catalog

Table of Contents



Safe-T-Link Appliance Connectors – F	
INTRODUCTORY PAGES	
FEATURED T&S PRODUCTS	
• SwiveLink, FreeSpin and POSI-SET Wheel Placement System	F3

Gas Appliance Connectors and Accessories	F3-9
---	-------------

• HG-2 Series (with FreeSpin fittings)	F4-5
• HG-2S Series (with SwiveLink fittings)	F4-5
• HG-4 Series (one quick-disconnect fitting)	F4-5
• HG-4S Series (with quick-disconnect and SwiveLink fittings)	F4-5
• HG-6 Series (with reversed quick-disconnect fittings)	F4-5
• HG-S Series (stationary appliance gas connectors)	F5
• Safe-T-Link Gas Hose fittings	F4-5
• How to Specify a Gas Appliance Connector	F6
• Gas Hose Installation Kit	F7
• Gas Appliance Connector Parts and Components	F7
• POSI-SET™ Wheel Placement System for Gas Appliances/Models	F7-8
• Gas Hose and Stationary Gas Hose Appliance Connector Capacities	F8
• SwiveLink Installation Instructions	F9

Water Appliance Connectors and Accessories	F10-11
---	---------------

• HW-2 Series (hose only)	F10
• HW-4 Series (with quick-disconnect fittings)	F10
• HW-6 Series (with reversed quick-disconnect fittings)	F10
• Water Appliance Connector Parts and Components	F10
• How to Specify a Water Appliance Connector	F11

Safe-T-Link Index By Model Number and Description	F12
--	------------

NOTE:
A comprehensive Index By Model or Part Number and Page can be found in the G-12 General Product Catalog Master Index section (IN).

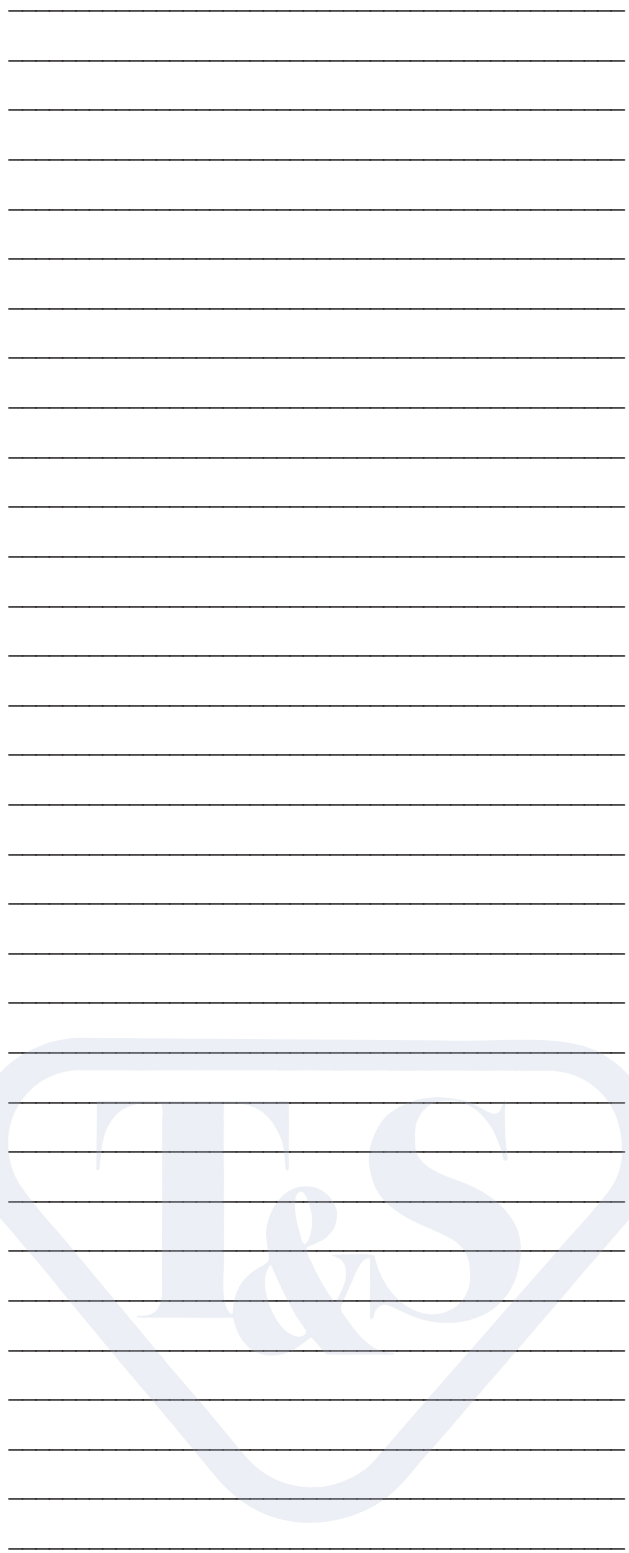

? **Can't find the T&S product you're looking for?**
Please visit www.tsbrass.com for a complete product listing.



RELIABILITY BUILT IN™

SAFE·T·LINK

www.tsbrass.com

More Reasons Than Ever To Connect With T&S

SwiveLink Performance Advantages

- Provides a consistent, stress-free torque-free swivel motion
- Eliminates kinking, allowing entire connector length to be used
- Optimal wall clearance. Castered appliances come out further to facilitate clean up, installation and maintenance, and may be pushed closer to the wall without connector interference
- Allows restraining devices to be set to engage just before the connector is fully extended
- Minimum folded length
- No lock-up during use
- Allows for full gas flow
- Double sealed, and machined from steel and brass for strength
- Available factory-attached on Safe-T-Link gas connector hoses, or as separate accessories for appliance and/or gas line attachment
- In popular sizes: 1/2" to 1 1/4"

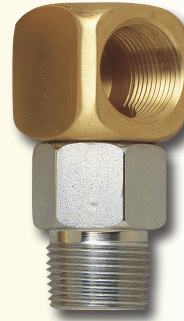

A True Gas Connector Swivel

Our patented SwiveLink can't lock up and meets ANSI Z21.69 for B.T.U. capacity, where gasoline swivels are limiting

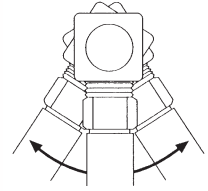

Usable length of hose with SwiveLink

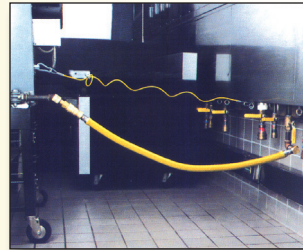

Usable length of hose WITHOUT SwiveLink



FreeSpin Performance Advantages

- 360° rotatable hex nut rotates completely and freely, even when tight. No more twisted hoses!
- Optimum torsional relief improves safety, increases connector life
- No more struggling with multiple fitting pieces and extra threads
- No more turning hoses to tighten fittings
- Provides efficient, full gas flow in every size
- Tapered fittings provide a tighter fit than traditional flared fittings
- Simple, easy to install
- Standard on both ends of every Safe-T-Link gas connector hose
- Available in sizes 1/2" through 1 1/4"

LIMITED
5
YEAR
WARRANTY



Attention: California Residents California's Proposition 65 requires that California consumers receive warnings about any products which contain chemicals known to the State of California to cause cancer or birth defects or other reproductive harm. The State of California requires the following notice: **WARNING:** This product contains chemicals known to the State of California to cause cancer, and birth defects or other reproductive harm.

POSI-SET™ Wheel Placement System

- Wheel placement system for moveable cooking equipment
- Designed for the positive placement of moveable gas equipment
- Ensures proper relocation of equipment after moving, cleaning or repairs
- Made of flame retardant thermoplastic resin
- Virtually indestructible
- Includes mounting hardware for proper installation
- Designed to meet the requirements of NFPA 17A 5.6.4 2009 Edition
- Patent No. US 7,581,623



See page F7 - F8 for more POSI-SET™ information

Safe-T-Link SwiveLink (standard, gas only)

Specify the new **SwiveLink** swivel, the ultimate connector accessory, and you gain increased mobility and critical space savings over fixed-end products. For the first time, let SwiveLink connect you to the ultimate convenience of utilizing 100% of the connector's overall length.

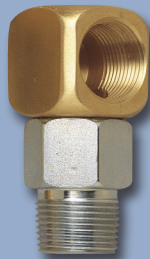

Safe-T-Link FreeSpin (standard, gas only)

With the new **FreeSpin** feature, you hook up with the most technically advanced end fitting available in the industry. These "live" ends – standard on both ends of the T&S Safe-T-Link gas connectors – provide a constant 360° rotation for reducing stress while extending connector life. Plus, the entire fitting design helps increase operational safety.



Quick-Disconnect Advantages

- For use when you need a Quick-disconnect located at the **back of the appliance**
- Quick-disconnect socket acts as shut-off valve when the plug and socket are disconnected
- "Fusible link" quick-disconnect gas hoses automatically shut off gas supply to the appliance when temperatures exceed 350°F (177°C)
- High quality construction
- CSA approval
- Easy operation



Reversed Quick-Disconnect Advantages

- For use when you need a Quick-disconnect located at the **wall**
- Quick-disconnect socket acts as shut-off valve when the plug and socket are disconnected
- "Fusible link" quick-disconnect gas hoses automatically shut off gas supply to the appliance when temperatures exceed 350°F (177°C)
- High quality construction
- CSA approval
- Easy operation



Welded Fittings

A gas connector is only as good as its weakest link. Trust our welded fittings to remain gas-tight long after a competitor's crimped assembly begins to loosen.

Extruded Coating

Strong does not have to mean less flexible. Our extruded coating stays out of the braid and keeps a constant wall thickness, providing strength and flexibility. Dipped coatings invade the stainless steel braid and stress the wires while reducing flexibility.

Safest Stainless Braid

Stainless braids protect the thin inner hose from pressure and stress. Trust our tight braid pattern to prevent punctures or dents more than a gapped braid.



SAFE-T-LINK



Hot and cold water appliance connectors are also available; see pages F10-11

Attention: California Residents

California's Proposition 65 requires that California consumers receive warnings about any products which contain chemicals known to the State of California to cause cancer or birth defects or other reproductive harm. The State of California requires the following notice: **WARNING:** This product contains chemicals known to the State of California to cause cancer, and birth defects or other reproductive harm.

Gas Appliance Connectors

- Welded fittings
- Extruded coating
- Stainless braid
- Available in sizes from 1/2" to 1 1/4" NPT
- See p. F6 for available configurations

HG-2 Series with FreeSpin Fittings

- FreeSpin rotating gas fittings on both ends, male to male
- Welded fitting connections
- Safe stainless braid
- Extruded coating
- 1/2 PSI max. gas pressure
- Includes (2) elbows



HG-4 Series with Quick-Disconnect End

- Quick-disconnect one end, FreeSpin rotating gas fitting other end
- Welded fitting connections
- Safe stainless braid
- Extruded coating
- 1/2 PSI max. gas pressure
- "Fusible link" quick-disconnect gas hoses automatically shut off gas supply to the appliance when temperatures exceed 350°F (177°C)
- Includes (1) elbow and (1) street elbow

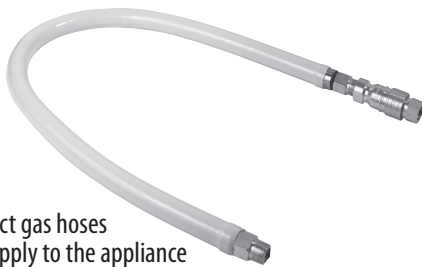

HG-6 Series Reversed Quick-Disconnect

- Male to quick-disconnect plug (reversed quick-disconnect) one end, FreeSpin rotating gas fitting other end
- Welded fittings
- Extruded coating
- Stainless steel braid hose
- 1/2 PSI max. gas pressure
- "Fusible link" quick-disconnect gas hoses automatically shut off gas supply to the appliance when temperatures exceed 350°F (177°C)
- Includes (1) elbow and (1) street elbow
- HG-6-S Series – includes (2) elbows



HG-2-S Series with SwiveLink Fittings

- Add an "S" to include SwiveLink swivels at both ends
- Maximum clearance from wall
- Minimum folded length
- Stress-free and torque-free motion
- No lock-up position
- 1/2 PSI max. gas pressure
- Includes (2) elbows



HG-4-S Series with Quick-Disconnect and SwiveLink Ends

- Add an "S" to include SwiveLink swivels at both ends
- Maximum clearance from wall
- Minimum folded length
- Stress-free and torque-free motion
- No lock-up position
- 1/2 PSI max. gas pressure
- "Fusible link" quick-disconnect gas hoses automatically shut off gas supply to the appliance when temperatures exceed 350° F (177°C)
- Includes (2) elbows



HG-S Series Stationary Appliance Gas Connectors

- Stainless steel stationary appliance gas connector
- 3/4" NPT female threads
- 36" to 48" length
- 1/2 PSI max. gas pressure



Gas Hose Fittings

FreeSpin Fittings

- Standard on both gas hose ends
- Freely rotates 360° even when tight, ending twisted hoses
- Hose does not have to turn to tighten fittings
- Available in sizes 1/2" through 1 1/4" NPT male
- 1/2 PSI max. gas pressure

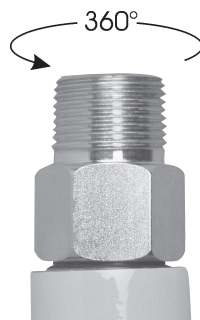

SwiveLink Fittings

- Provides the most reach with the shortest hose
- Reduces stress on the hose, eliminating kinking
- Keeps gas flow unrestricted
- Patented design; can't lock up
- Meets ANSI Z21.69 for B.T.U. capacity
- Available in sizes 1/2" through 1 1/4"
- 1/2 PSI max. gas pressure



Gas Appliance Connectors – Specifications

HG-2	(2) FreeSpin fittings
HG-2-S	(2) SwiveLink fittings
HG-4	(1) FreeSpin fitting, (1) Quick-disconnect fitting
HG-4-S	(2) SwiveLink fittings
HG-6	(1) FreeSpin fitting, (1) Male to Quick-disconnect fitting
HG-S	(2) Stationary fittings

Specifying An HG-2 and HG-4 Gas Appliance Connector

F 6

Hose Design

Male to Male	Order	2
Male to Quick-Disconnect	Order	4

Internal Thread and Diameter

1/2" N.P.T.	Order	C
3/4" N.P.T.	Order	D
1" N.P.T.	Order	E
1 1/4" N.P.T.	Order	F

Length	Order
24"	24
36"	36
48"	48
60"	60
72"	72

Example:
Gas hose and Installation Kit with Quick-Disconnect, 3/4" N.P.T. and 48" long with SwiveLink fittings:

HG – 4D – 48SK

Suffixes

SwiveLink

Add SwiveLink fitting to both ends of the hose assembly

Order **S***

Installation Kit

Includes everything necessary for an installation

Order **K***

POSI-SET™

Includes one pair POSI-SET (Wheel Placement System for Moveable Cooking Equip.)

Order **PS****

* You may add an "S" and/or "K" suffix to your order

** Models -2C, -2D, -4C, -4D and -4E only



HG-2

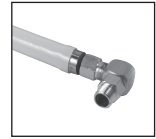

HG-2S

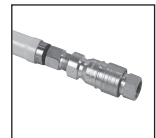

HG-4

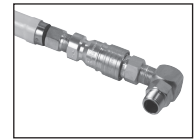

HG-4S

Specifying An HG-6 Gas Appliance Connector

HG-6

Thread and Diameter

1/2" N.P.T.	Order	C
3/4" N.P.T.	Order	D
1" N.P.T.	Order	E
1 1/4" N.P.T.	Order	F

Hose Length

Order	
24"	24
36"	36
48"	48
60"	60
72"	72

Example:

Gas hose with Reverse Quick-Disconnect, 3/4" N.P.T., 48" long:

HG – 6D – 48



HG-6

Specifying A Stationary Appliance Connector

HG-S

Thread and Diameter

Order	
3/4"	D

Hose Length

Order	
36"	36
48"	48

Example:

Stationary gas hose, 3/4" diameter, 48" long:

HG – SD – 48



HG-S



Gas Appliance Installation Kit

Gas Hose with Installation Kit

Add a "K" suffix to hose model number (see p. F6) to include all necessary pieces to install a gas appliance.

Each kit includes:

- One 90° street elbow
- One CSA-certified foodservice gas ball valve
- One SureLink restraining cable, adjustable from 3' to 5' lengths (#010625-45)
- All necessary hardware

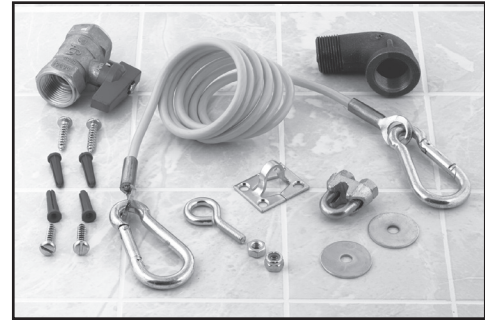

K Model Installation Kit

Order with these model numbers when you only want the kit:

1/2" Kit	AG-KC
3/4" Kit	AG-KD
1" Kit	AG-KE
1 1/4" Kit	AG-KF
5' cable w/ hardware	AG-RC

Gas Appliance Parts, Components and Accessories

Two-Piece Quick-Disconnect

1/2"	AG-5C
3/4"	AG-5D
1"	AG-5E
1 1/4"	AG-5F



SwiveLink

1/2"	AG-6C
3/4"	AG-6D
1"	AG-6E
1 1/4"	AG-6F



Elbows

• All Elbows are in compliance with ASTM standards

Female-Male Street El*

1/2"	AG-8C-MF
3/4"	AG-8D-MF
1"	AG-8E-MF
1 1/4"	AG-8F-MF

Female-Female Elbow (not shown)

1/2"	AG-8C-FF
3/4"	AG-8D-FF
1"	AG-8E-FF
1 1/4"	AG-8F-FF



Female-Male Street El

* Use of Street Els prohibited in Canada

Gas Ball Valve

1/2"	AG-7C
3/4"	AG-7D
1"	AG-7E
1 1/4"	AG-7F



POSI-SET™ Wheel Placement System

- Wheel placement system for moveable cooking equipment
- Designed for the positive placement of moveable gas equipment
- Ensures proper relocation of equipment after moving, cleaning or repairs
- Made of flame retardant thermoplastic resin
- Virtually indestructible
- Includes mounting hardware for proper installation
- Designed to meet the requirements of NFPA 17A 5.6.4 2009 Edition
- Patent No. US 7,581,623



See Page F8 for POSI-SET™ Gas Hose Models

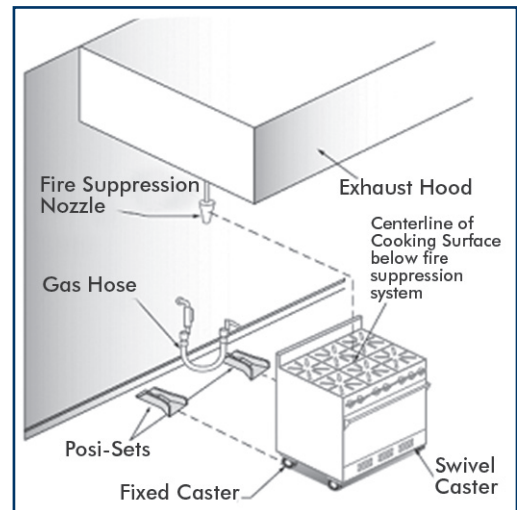

Safe-T-Link Gas Appliance Hoses and POSI-SET™ Models

- POSI-SET™ is also available bundled together with our most popular Safe-T-Link Gas Hose models
- Refer to the list at right for available model numbers
- One pair of POSI-SET™ included with each gas hose model
- Add "-PS" to hose model

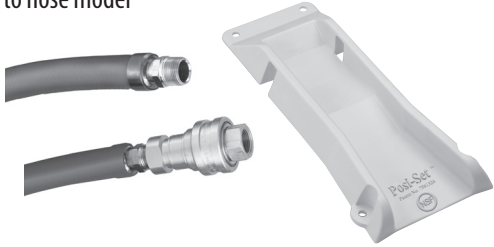

POSI-SET™ Models:

HG-2C-36-PS	HG-4D-36SK-PS	HG-4D-60-PS
HG-2C-48-PS	HG-4D-48-PS	HG-4D-60S-PS
HG-4C-48K-PS	HG-4D-48K-PS	HG-4D-60SK-PS
HG-4C-48SK-PS	HG-4D-48S-PS	HG-4E-48K-PS
HG-4D-36-PS	HG-4D-48SEL-PS	HG-4E-48SK-PS
HG-4D-36K-PS	HG-4D-48SK-PS	

F
8

Gas Appliance Connectors Capacity

Minimum BTU per hour (in thousands)
Ref: ANSI Z21.69 / CSA 6.16



	12"	24"	36"	48"	60"	72"	
HG-2	C= 1/2"	166	150	125	106	95	86
	D= 3/4"	320	291	250	215	200	174
	E= 1"	639	582	515	443	395	348
	F= 1 1/4"	1185	1075	945	818	735	634

	12"	24"	36"	48"	60"	72"	
HG-2-S	C= 1/2"	140	129	111	97	90	84
	D= 3/4"	320	291	250	215	200	174
	E= 1"	639	582	515	443	395	348
	F= 1 1/4"	1144	1042	926	809	735	634

	12"	24"	36"	48"	60"	72"	
HG-4 HG-4-S	C= 1/2"	92	85	75	70	65	55
	D= 3/4"	259	235	220	180	160	140
	E= 1"	455	420	380	335	290	280
	F= 1 1/4"	770	700	620	540	475	420

	12"	24"	36"	48"	60"	72"	
HG-6	C= 1/2"	92	85	75	70	65	55
	D= 3/4"	259	235	220	180	160	140
	E= 1"	455	420	380	335	290	280
	F= 1 1/4"	770	700	620	540	475	420

Stationary Appliance Connectors Capacity

Minimum BTU per hour (in thousands)

Ref: ANSI Z21.24 / CSA 6.10
ANSI Z21.75 / CSA 6.27

	36"	48"
HG-S D= 3/4"	128	106



SwiveLink Installation Instructions

Specify the T&S SwiveLink swivel, the ultimate connector accessory, and you gain increased mobility and critical space savings over fixed-end products.

For the first time, let SwiveLink connect you to the ultimate convenience of utilizing 100% of the connector's overall length.

- Provides the most reach with the shortest hose
- Reduces stress on the hose, eliminating kinking
- Keeps gas flow unrestricted
- Patented design; can't lock up
- Meets ANSI Z21.69 for B.T.U. capacity
- Available in sizes 1/2" through 1 1/4"
- 1/2 PSI max. gas pressure

WARNING: Per the ANSI Z21.69 / CSA 6.16 Standard, Gas Connectors cannot be reused when an appliance is being replaced or moved to a new location.

Combination Loop with SwiveLink

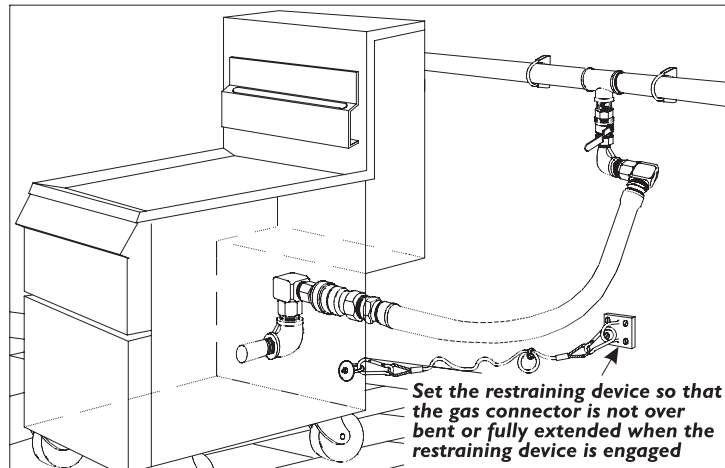

Horizontal Loop with SwiveLink

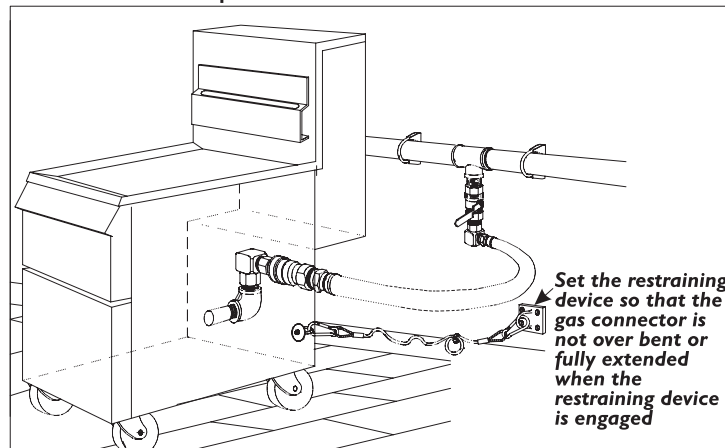

Usable length of hose with SwiveLink

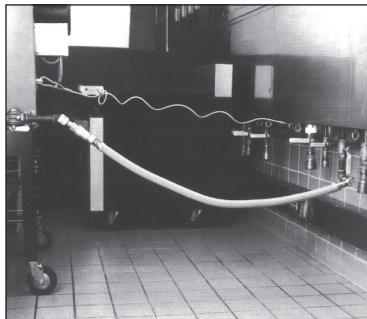

Usable length of hose WITHOUT SwiveLink

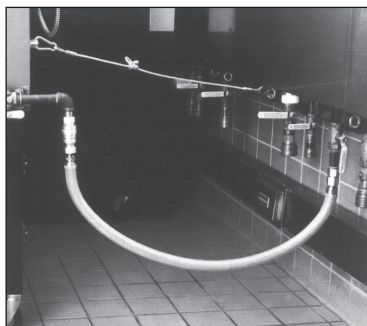

Vertical Loop with SwiveLink

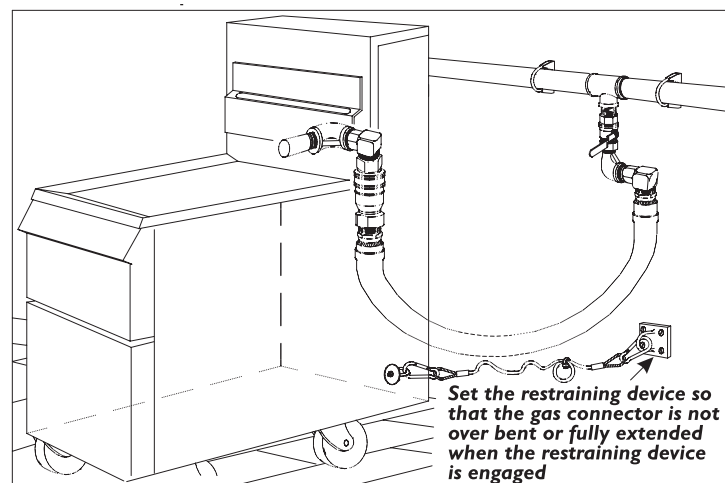

Water Appliance Connectors

- Hot and cold water appliance connectors
- Welded fittings
- Extruded coating
- Stainless braid
- Rated to 175°F maximum
- Available in sizes: $\frac{3}{8}$ " , $\frac{1}{2}$ " and $\frac{3}{4}$ "
- See p. F11 for available model numbers

HW-2 Series Water Appliance Connectors

- Male to male end fittings
- Welded fitting connections
- Coated stainless steel hose
- Extruded coating



HW-4 Series with Quick-Disconnect

- Male to quick-disconnect fittings
- Welded fitting connections
- Coated stainless steel hose
- Extruded coating

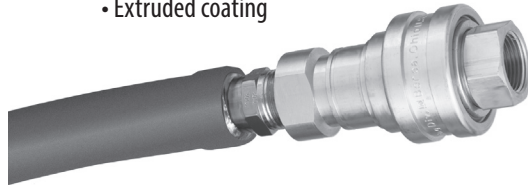

HW-6 Series Reversed Quick-Disconnect Cold Water Hoses

- Male to quick-disconnect plug (reversed quick-disconnect)
- Welded fittings
- Extruded coating
- Stainless steel braid hose

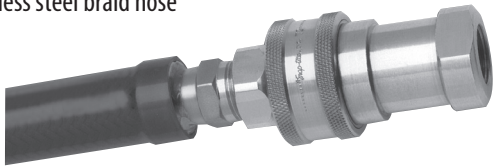

F 10

Water Appliance Parts and Components

Stainless Steel Quick-Disconnect

- Both socket and plug are valved for leak free disconnection

$\frac{1}{4}$ "	AW-5A
$\frac{3}{8}$ "	AW-5B
$\frac{1}{2}$ "	AW-5C
$\frac{3}{4}$ "	AW-5D



Water Appliance Connectors – Specifications

Specifying An HW-2 and HW-4 Water Appliance Connector

HW - _____ - _____

Hose Design		Order	Length		Order
Male to Male		2	24"		24
Male to Quick-Disconnect		4	36"		36
			48"		48
			60"		60
			72"		72
			72" with Vacuum Breaker		72VB

Thread and Diameter	Order
3/8"	B
1/2"	C
3/4"	D

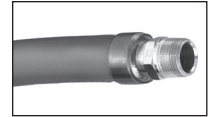

HW-2

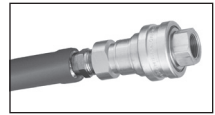

HW-4

Example:
Water hose with Quick-Disconnect,
3/4" diameter and 48" long:

HW – 4D – 48

Note: Not all combinations are available. Check the "Index By Model Number" on page F12 for availability, or call T&S Customer Service.

F
11

Specifying An HW-6 Water Appliance Connector

HW - 6 _____ - _____

N.P.T. Thread, Male		Order	Hose Length		Order
3/8"		B	36"		36
1/2"		C	48"		48
3/4"		D	60"		60
			72"		72

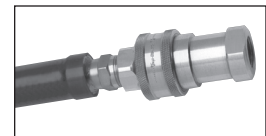

HW-6

Example:
Water hose with Reverse Quick-Disconnect, 1/2" N.P.T. and 36" long:

HW – 6C – 36





Listed alphabetically by model number

F
12

Model	Description
GAS APPLIANCE CONNECTORS	
AG-5C	Gas QUICK-DISCONNECT-1/2"
AG-5D	Gas QK-DISCONNECT-3/4" NPT
AG-5E	Gas QK-DISCONNECT-1" NPT
AG-5F	Gas QUICK-DISCONNECT-1 1/4"
AG-6C	Gas SWIVELINK-1/2" NPT MA
AG-6D	Gas SWIVELINK-3/4" NPT MA
AG-6E	Gas SWIVELINK-1" NPT MA x
AG-6F	Gas SWIVELINK-1 1/4" NPT
AG-7D	Gas BALL VALVE-3/4" NPT
AG-8C-MF	Gas STREET EL-1/2" NPT M x F
AG-8D-FF	Gas ELBOW-3/4" NPT FE x FE
AG-8D-MF	Gas STREET EL-3/4" NPT M x F
AG-8E-MF	Gas STREET EL-1" NPT M x F
AG-KC	Gas Kit-CABLE VALVE EL-1/2"
AG-KD	Gas Kit CABLE VALVE EL-3/4"
AG-KE	Gas Kit CABLE VALVE EL-1"
AG-KF	Gas Kit CABLE VALVE EL-1 1/4"
AG-RC	5 ft. CABLE w/ HARDWARE
HG-2C-36	Gas Hose 1/2" NPT x 36" Lngth.
HG-2C-36K	Gas Hose 1/2" X 36" KIT
HG-2C-36S	Gas Hose 1/2" x 36" SWIVEL
HG-2C-48	Gas Hose 1/2" NPT x 48" Lngth.
HG-2C-48K	Gas Hose 1/2" x 48" KIT
HG-2C-48S	Gas Hose 1/2" x 48" SWIVEL
HG-2C-48SK	Gas Hose 1/2" x 48" SW KIT
HG-2C-60	Gas Hose 1/2" NPT x 60" Lngth.
HG-2C-72	Gas Hose 1/2" NPT x 72" Lngth.
HG-2C-72K	Gas Hose 1/2" NPT x 72" KIT
HG-2D-24	Gas Hose 3/4" NPT x 24" Lngth.
HG-2D-24K	Gas Hose 3/4" x 24" KIT
HG-2D-24S	Gas Hose 3/4" x 24" SWIVEL
HG-2D-24SK	Gas Hose 3/4" x 24" SW KIT
HG-2D-36	Gas Hose 3/4" NPT x 36" Lngth.
HG-2D-36K	Gas Hose 3/4" x 36" KIT
HG-2D-36S	Gas Hose 3/4" x 36" SWIVEL
HG-2D-36SK	Gas Hose 3/4" x 36" SW KIT
HG-2D-48	Gas Hose 3/4" NPT x 48" Lngth.
HG-2D-48K	Gas Hose 3/4" x 48" KIT
HG-2D-48S	Gas Hose 3/4" x 48" SWIVEL
HG-2D-48SK	Gas Hose 3/4" x 48" SW KIT
HG-2D-60	Gas Hose 3/4" NPT x 60" Lngth.
HG-2D-60S	Gas Hose 3/4" x 60" SWIVEL
HG-2D-60SK	Gas Hose 3/4" x 60" SW KIT
HG-2D-72	Gas Hose 3/4" NPT x 72" Lngth.
HG-2D-72K	Gas Hose 3/4" x 72" KIT
HG-2D-72S	Gas Hose 3/4" x 72" SWIVEL
HG-2D-72SK	Gas Hose 3/4" x 72" SW KIT
HG-2E-36	Gas Hose 1" NPT x 36" Lngth.
HG-2E-36K	Gas Hose 1" x 36" KIT
HG-2E-36S	Gas Hose 1" x 36" SWIVELS
HG-2E-36SK	Gas Hose 1" x 36" SW KIT
HG-2E-48	Gas Hose 1" NPT x 48" Lngth.
HG-2E-48K	Gas Hose 1" x 48" KIT
HG-2E-48S	Gas Hose 1" x 48" SWIVELS

Model	Description
HG-2E-48SK	Gas Hose 1" x 48" SW KIT
HG-2E-60	Gas Hose 1" NPT x 60" Lngth.
HG-2E-60K	Gas Hose 1" x 60" KIT
HG-2E-60S	Gas Hose 1" x 60" SWIVELS
HG-2E-72	Gas Hose 1" NPT x 72" Lngth.
HG-2E-72K	Gas Hose 1" x 72" KIT
HG-2E-72S	Gas Hose 1" x 72" SWIVELS
HG-2F-48	Gas Hose 1 1/4" x 48" Lngth.
HG-2F-48K	Gas Hose 1 1/4" x 48" KIT
HG-2F-48SK	Gas Hose 1 1/4" x 48" SW KIT
HG-4C-36	Gas Hose 1/2" x 36" Q-D
HG-4C-36K	Gas Hose 1/2" x 36" Q-D KIT
HG-4C-36S	Gas Hose 1/2" x 36" SW Q-D
HG-4C-36SK	Gas Hose 1/2" x 36" Q-D SW KIT
HG-4C-48	Gas Hose 1/2" x 48" Q-D
HG-4C-48K	Gas Hose 1/2" x 48" Q-D KIT
HG-4C-48S	Gas Hose 1/2" x 48" SW Q-D
HG-4C-48SK	Gas Hose 1/2" x 48" Q-D SW KIT
HG-4C-60	Gas Hose 1/2" x 60" Q-D
HG-4C-60K	Gas Hose 1/2" x 60" KIT
HG-4C-60S	Gas Hose 1/2" x 60" SW Q-D
HG-4C-60SK	Gas Hose 1/2" x 60" Q-D SW KIT
HG-4C-72	Gas Hose 1/2" x 72" Q-D
HG-4C-72K	Gas Hose 1/2" x 72" KIT
HG-4C-72S	Gas Hose 1/2" x 72" SW Q-D
HG-4D-24	Gas Hose 3/4" x 24" Q-D
HG-4D-24K	Gas Hose 3/4" x 24" Q-D KIT
HG-4D-24S	Gas Hose 3/4" x 24" SW Q-D
HG-4D-24SK	Gas Hose 3/4" x 24" Q-D SW KIT
HG-4D-36	Gas Hose 3/4" X 36" Q-D
HG-4D-36K	Gas Hose 3/4" x 36" Q-D KIT
HG-4D-36S	Gas Hose 3/4" x 36" SW Q-D
HG-4D-36SK	Gas Hose 3/4" x 36" Q-D SW KIT
HG-4D-48	Gas Hose 3/4" x 48" Q-D
HG-4D-48K	Gas Hose 3/4" x 48" Q-D KIT
HG-4D-48S	Gas Hose 3/4" x 48" SW Q-D
HG-4D-48SK	Gas Hose 3/4" x 48" Q-D SW KIT
HG-4D-60	Gas Hose 3/4" x 60" Q-D
HG-4D-60K	Gas Hose 3/4" x 60" Q-D KIT
HG-4D-60S	Gas Hose 3/4" x 60" SW Q-D
HG-4D-60SK	Gas Hose 3/4" x 60" Q-D SW KIT
HG-4D-72	Gas Hose 3/4" x 72" Q-D
HG-4D-72K	Gas Hose 3/4" x 72" Q-D KIT
HG-4D-72S	Gas Hose 3/4" x 72" SW Q-D
HG-4D-72SK	Gas Hose 3/4" x 72" Q-D SW KIT
HG-4E-36	Gas Hose 1" NPT x 36" LNG Q-D
HG-4E-36K	Gas Hose 1" x 36" Q-D KIT
HG-4E-36S	Gas Hose 1" x 36" SW Q-D
HG-4E-36SK	Gas Hose 1" x 36" Q-D SW KIT
HG-4E-48	Gas Hose 1" NPT x 48" LNG Q-D
HG-4E-48K	Gas Hose 1" x 48" Q-D KIT
HG-4E-48S	Gas Hose 1" x 48" SW Q-D
HG-4E-48S-RC	Gas Hose 1" x 48" SW Q-D, RC KIT
HG-4E-48SK	Gas Hose 1" x 48" Q-D SW KIT

Model	Description
HG-4E-60	Gas Hose 1" NPT x 60" LNG Q-D
HG-4E-60K	Gas Hose 1" x 60" Q-D KIT
HG-4E-60S	Gas Hose 1" x 60" SW Q-D
HG-4E-60SK	Gas Hose 1" x 60" Q-D SW KIT
HG-4F-48	Gas Hose 1 1/4" x 48" LNG Q-D
HG-4F-48K	Gas Hose 1 1/4" x 48" Q-D KIT
HG-4F-48S	Gas Hose 1 1/4" x 48" SW Q-D
HG-4F-48SK	Gas Hose 1 1/4" x 48" Q-D SW
HG-4F-60	Gas Hose 1 1/4" NPT x 60" Q-D
HG-4F-60K	Gas Hose 1 1/4" x 60" Q-D KIT
HG-4F-60S	Gas Hose 1 1/4" x 60" SW Q-D
HG-4F-60SK	Gas Hose 1 1/4" x 60" Q-D SW K
HG-6D-48	Gas Hose RVS-Q-D 3/4" x 48"
HG-6D-72	Gas Hose RVS-Q-D 3/4" x 72"
HG-SD-36	Gas Hose Stationary 3/4" x 36"
HG-SD-48	Gas Hose Stationary 3/4" x 48"
WATER APPLIANCE CONNECTORS	
AW-5B	3/8" Brass Q-Disconnect
AW-5C	1/2" Brass Q-Disconnect
AW-5D	3/4" Brass Q-Disconnect
HW-2B-24	Water Hose, Male, 3/8" x 24"
HW-2B-36	Water Hose, Male, 3/8" x 36"
HW-2B-48	Water Hose, Male, 3/8" x 48"
HW-2B-72	Water Hose, Male, 3/8" x 72"
HW-2C-36	Water Hose, Male, 1/2" x 36"
HW-2C-48	Water Hose, Male, 1/2" x 48"
HW-2C-60	Water Hose, Male, 1/2" x 60"
HW-2C-72	Water Hose, Male, 1/2" x 72"
HW-2D-48	Water Hose, Male, 3/4" x 48"
HW-4B-24	Water Hose w/Q-D, 3/8" x 24"
HW-4B-36	Water Hose w/Q-D, 3/8" x 36"
HW-4B-48	Water Hose w/Q-D, 3/8" x 48"
HW-4B-72	Water Hose w/Q-D, 3/8" x 72"
HW-4B-72VB	Water Hose w/Q-D, Vacuum Breaker, 3/8" x 72"
HW-4C-36	Water Hose w/Q-D, 1/2" x 36"
HW-4C-48	Water Hose w/Q-D, 1/2" x 48"
HW-4C-60	Water Hose w/Q-D, 1/2" x 60"
HW-4C-72	Water Hose w/Q-D, 1/2" x 72"
HW-4C-72VB	Water Hose w/Q-D, Vacuum Breaker, 1/2" x 72"
HW-4D-48	Water Hose w/Q-D, 3/4" x 48"
HW-6C-36	Water Hose w/RVS-Q-D, 1/2" x 36"
HW-6C-48	Water Hose w/RVS-Q-D, 1/2" x 48"
HW-6D-48	Water Hose w/RVS-Q-D, 3/4" x 48"

See Page F8 for POSI-SET™ Gas Hose Models

NOTE: A comprehensive Index By Model or Part Number and Page can be found in the G-12 General Product Catalog Master Index section (IN).



RELIABILITY BUILT IN™

G-12

 *Parts Kits*



Parts Kits – G

Pre-Rinse Units G3

- Pre-Rinse Units – Repair, Installation G3

Spray Valves G3-4

Repair Kits:

- B-0107 (1.15 GPM) G3
- EB-0107 High Flow Spray Valve G4
- B-0107-C (0.65 GPM) and B-0107-J (1.07 GPM) Spray Valves G4
- B-0108 (1.48 GPM) and B-0108-C (0.65 GPM) JeTSpray Valves G4

Cartridges and Spindle Assemblies G5-7

- Cartridges and Spindle Assemblies
- Parts and Repair Kits G5-7

Faucets G7-8

- Faucet Parts and Repair Kits G7-8

Handles G8

- Handle Parts and Replacement Kits G8

Plumbing and Waste Valves G9

- Parts and Repair Kits G9

Parts Kits for Faucet Installation G9

Glass Filler Repair Kits G10

Vacuum Breaker Repair Kits G10

TIP

• Find Nozzles, Aerators and other Outlets, Goosenecks and Cartridges in the **Accessories section (ACS)**.

NOTE:

A comprehensive Index By Model or Part Number and Page can be found in the G-12 General Product Catalog Master Index section (IN).



? Can't find the T&S product you're looking for? Please visit www.tsbrass.com for a complete product listing.

Note: Some individual items listed in parts kits may be ordered separately. Contact T&S factory Customer Service representatives for availability.

Repair and Installation Kits – Pre-Rinse Units

B-0114-RK Roto-Flex Repair Kit



- B-0114 style pre-rinse unit repair kit
- Includes materials to repair both knuckles and elbow

B-PRU-RK Pre-Rinse Repair Kit

- Includes:
- 1 (012665-45) Lubricant
- 3 (001014-45) Hose barrel washers
- 2 (010476-45) #27 Washers
- 1 (001074-45) Swivel 'O'-Ring
- 2 (011429-45) Swivel sleeve
- 1 (001065-45) EasyInstall 'O'-ring
- 1 (014200-45) Serrated lock washer
- 2 (001019-45) Coupling nut washers

BF-PRU-RK Big-Flo Pre-Rinse Repair Kit

- Includes:
- 1 (012665-45) Lubricant
- 3 (001014-45) Hose barrel washers
- 2 (010476-45) #27 Washers
- 3 (000764-20) Removable seat
- 1 (016807-45) Serrated lock washer
- 4 (001068-45) EasyInstall 'O'-rings
- 2 (001019-45) Coupling nut washers

B-0113-K Pre-Rinse Spare Parts Kit

- Includes:
- 1 (000821-40) Spring body
- 1 (000358-40) 3/8" x 3" nipple
- 1 (000888-45) Overhead spring

B-0107 Spray Valve Repair Kits



B-0107 Spray Face (1.15 GPM)



B-10K B-0107 (1.15 GPM) Spray Valve Repair Kit

- | | |
|-------------------------------------|--------------------------------|
| 2 (000895-45) Spring | 2 (012915-45) Seat washer |
| 2 (000974-45) Bonnet washer | 1 (007861-45) Spray head ring |
| 2 (010476-45) Hose washer | 1 (000913-45) Spray face screw |
| 2 (001100-45) Stem packing | 1 (001121-45) Spray face |
| 2 (009306-20) Valve stem | |
| 2 (001040-45) Bonnet binding washer | |



B-16K B-0101 Spray Valve with Rosespray Outlet

- Parts included:
- 1 (000894-45) Spring
- 2 (000974-45) B-0107 bonnet washer
- 2 (010476-45) #27 washer
- 1 (001062-45) 'O'-Ring
- 2 (012915-45) Seat washer
- 2 (001100-45) Stem packing

B-24K B-0107 Spray Face Repair Kit

- Repairs B-0107 Spray valve face:
- 1 (007861-45) Spray head ring
- 1 (000913-45) Spray face screw
- 1 (001121-45) B-0107 spray face



002856-40 B-0107 Spray Valve Bonnet Assembly

- B-0107 spray valve bonnet assembly

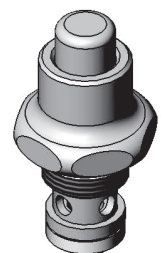

Note: Some individual items listed in parts kits may be ordered separately. Contact T&S factory Customer Service representatives for availability.

EB-0107 High Flow Spray Valve Repair Kit

EB-10K EB-0107 Spray Valve Repair Kit

- | | |
|------------------------------------|-------------------------------------|
| 4 (000974-45) Bonnet washer | 1 (011456-45) Blue spray face |
| 2 (010476-45) Hose washer | 2 (000895-45) Spring |
| 2 (009306-20) Valve stem | 2 (010565-45) Washer bonnet binding |
| 1 (011475-45) Blue spray head ring | 2 (014615-45) Packing seal |
| 1 (000913-45) Spray face screw | 2 (010563-45) Seat washer |



B-0107-C and B-0107-J Spray Valve Repair Kits

B-10K-C B-0107-C (0.65 GPM) Low Flow Spray Valve Repair Kit

• Parts included for the B-0107-C Spray Valve:

- 2 (000895-45) Spring
- 2 (000974-45) Bonnet washer
- 2 (010476-45) #27 hose washer
- 2 (001040-45) Bonnet binding washer
- 2 (002659-45) Shield
- 2 (001100-45) Packing seal
- 2 (009306-20) Valve stem
- 2 (012915-45) Seat washer



B-10K-J B-0107-J (1.07 GPM) Spray Valve Repair Kit

• Parts included for the B-0107-J Spray Valve:

- 2 (000895-45) Spring
- 2 (000974-45) Bonnet washer brass
- 2 (010476-45) #27 hose washer
- 2 (001040-45) Bonnet binding washer
- 2 (018292-45) Grey shield
- 2 (001100-45) Packing seal
- 2 (009306-20) Valve stem
- 2 (012915-45) Seat washer



B-0108 and B-0108-C JeTSpray Valve Repair Kits

Note: Individual items for the B-0108 spray valve are not sold separately.



NEW B-0108 FLOW RATE!

B-0108 (1.07 GPM)
B-0108-C (0.65 GPM)

108V-RK B-0108 JeTSpray Valve Repair Kit

Kit includes:

- Spanner bit
- End plug assembly
- Silicon grease
- Valve assembly
- Compression spring

108T-RK B-0108 JeTSpray Trigger Repair Kit

Kit includes:

- 6-32 x 3/8" screws (2)
- Silicon grease
- Spring trigger catch sub-assembly
- Stainless steel trigger
- Thread locking compound
- Pivot pin assembly

108S-RK B-0108 JeTSpray Screen/ Washer Repair Kit

Kit includes:

- Inlet filter
- Tube of Loctite



108SF-RK B-0108 JeTSpray Spray Face Repair Kit

Kit includes:

- Washer
- 2019 DOE compliant B-0108 spray face (1.07 GPM)



108CSF-RK B-0108-C Low Flow JeTSpray Spray Face Repair Kit

Kit includes:

- Washer
- 2019 DOE compliant B-0108-C spray face (0.65 GPM)



108HSF-RK B-0108-H JeTSpray High Flow Spray Face Repair Kit

Kit includes:

- Washer
- Non-2019 DOE compliant B-0108-H high flow spray face (3.28 GPM)

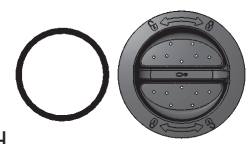

Note: Some individual items listed in parts kits may be ordered separately. Contact our T&S factory Customer Service representatives for availability.

Repair Kits – Cartridges and Spindle Assemblies

B-0290-K Repair Kit for Big-Flo Faucets

- 4 (001075-45) 'O'-Rings
- 2 (009752-45) Bonnet washers
- 2 (000933-45) Seat washer screws
- 2 (000976-45) Washer
- 2 (002726-45) Bonnet washer
- 2 (001042-45) Bonnet washer
- 2 (002721-45) 'O'-Rings
- 2 (001088-45) Seat washers
- 2 (000764-20) Removable seats

B-1K Eterna Parts Kit

- 2 (000933-45) Seat washer screws
- 2 (001022-45) Bottom gaskets
- 2 (002601-45) Top gaskets
- 2 (001092-45) Seat washers
- 2 (001098-45) Eterna packing seals

B-6RK Cartridge Repair Kit

- 4 (000933-45) Seat washer screws
- 4 (001022-45) Bottom gaskets
- 4 (002601-45) Top gaskets
- 8 (001092-45) Seat washers
- 8 (003164-45) Spring check washers
- 2 (012915-45) B-0107 seat washers
- 4 (013430-45) Eterna packing seals
- 2 (001040-45) Bonnet binding washers
- 4 (000974-45) Bonnet washers
- 4 (001479-45) Spring check springs
- 2 (001100-45) Stem packing
- 4 (001014-45) Hose barrel washers
- 6 (010476-45) #27 washers



B-5K Old Style B-0230 Faucet Repair Kit

Note: Used on B-0230 spindles prior to barrel type assemblies (old style):

- 1 Right-hand spindle
- 1 Left-hand spindle
- 6 Removable seats
- 4 Seat screws
- 12 Washers
- 12 Bonnet washers
- 12 Washers
- 22 Seat washers
- 12 Big-Flo bonnet assemblies



B-6K Eterna Spindle Parts Kit

- 1 (000788-20) Right-hand Eterna insert
- 1 (000789-20) Left-hand Eterna insert
- 1 (000811-25) Right-hand spindle insert
- 1 (000812-25) Left-hand spindle insert
- 4 (000933-45) Seat washer screws
- 10 (001022-45) Bottom gaskets
- 12 (002601-45) Top gaskets
- 22 (001092-45) Seat washers
- 6 (001098-45) Spindle packing



B-7K Master Parts Kit for Eterna Spindles



- Included in box:
- 12 (000788-20) Right-hand Eterna inserts
- 6 (000789-20) Left-hand Eterna inserts
- 12 (000811-25) Right-hand spindle inserts
- 6 (000812-25) Left-hand spindle inserts
- 6 (000718-25) Packing nuts
- 12 (000922-45) Lever handle screws
- 32 (000933-45) Seat washer screws
- 25 (002601-45) Top gaskets
- 25 (001022-45) Bottom gaskets
- 25 (001074-45) Swing nozzle 'O'-rings
- 32 (001092-45) Seat washers
- 50 (001098-45) Packings

B-7K-NS Master Parts Kit for New Style Eterna Spindles

- Included in box:
- 12 (000788-20) Right-hand Eterna inserts
- 6 (000789-20) Left-hand Eterna inserts
- 12 (019780-40) Right-hand spindle inserts
- 6 (019779-40) Left-hand spindle inserts
- 6 (000718-25NS) Packing nuts
- 12 (000925-45) Lever handle screws
- 32 (003164-45) Seat washers
- 25 (002601-45) Top gaskets
- 25 (001022-45) Bottom gaskets
- 25 (001074-45) Swing nozzle 'O'-rings
- 50 (001098-45) Packings
- 12 (001466-20) Spindle Sleeve
- 12 (001479-45) Spring Check



Note: Some individual items listed in parts kits may be ordered separately. Contact our T&S factory Customer Service representatives for availability.

Parts and Repair Kits – Cartridges and Spindle Assemblies

B-8K Push Button Metering Parts Kit

- Included in sorting tray and case:
 - 6 (000788-20) Right-hand removable insert, Hot
 - 6 (000789-20) Left-hand removable insert, Cold
 - 10 (001022-45) Bottom gasket
 - 10 (001092-45) Seat washer
 - 10 (000933-45) Seat washer screw
 - 6 (014152-40K) Seal kit
 - 25 (012596-45) Bottom seal
 - 3 (000811-25) Left-hand Eterna spindle assembly, Cold
 - 3 (000812-25) Right-hand Eterna spindle assembly, Hot
 - 1 (014193-40) Blank push button cap assembly w/ spanner bit
 - 1 (238A) Cartridge
 - 2 (014152-40) Metering barrel assembly
 - 10 (000922-45) Lever handle screw
 - 12 (002601-45) Top gasket
 - 12 (013430-45) Eterna bonnet packing seal
 - 6 (000718-25NS) Packing nut

B-8K-NS New Style Push Button Metering Parts Kit

- Included in sorting tray and case:
 - 6 (000788-20) RH removable Insert, Hot
 - 6 (000789-20) LH removable Insert, Cold
 - 10 (001022-45) Bottom gasket
 - 10 (003164-45) Seat washer
 - 6 (014152-40K) Seal kit
 - 25 (012596-45) Bottom seal
 - 3 (019779-40) LH Eterna spindle assembly, Cold
 - 3 (019780-40) RH Eterna spindle assembly, Hot
 - 1 (014193-40) Blank push button cap asm. w/ spanner bit
 - 1 (238A) Cartridge
 - 2 (014152-40) Metering barrel assembly
 - 10 (000925-45) Lever handle screw
 - 10 (001479-45) Spring
 - 10 (001466-20) Spindle sleeve
 - 12 (002601-45) Top gasket
 - 12 (001098-45) Eterna bonnet packing seal
 - 6 (000718-25NS) Packing nut

B-20K B-1100 Faucets Parts Kit

- Included:
 - 1 (000800-25) Right-hand spindle
 - 1 (000801-25) Left-hand spindle
 - 2 (000933-45) Seat washer screws
 - 2 (000986-45) Bonnet washers
 - 2 (002726-45) Bonnet washers, S/S
 - 2 (001074-45) 'O'-rings
 - 2 (001092-45) Seat washers
 - 4 (010196-25) B-1100 Bonnet assembly (includes 'O'-Rings and washer)
 - 2 (001047-25) Bonnet washers
 - 2 (000763-20) Removable seats

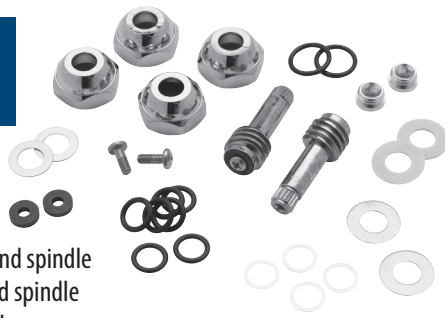

B-11K Eterna Cartridge Spindle Kit

- Included:
 - 1 (000811-25) Right-hand spindle assembly with seat washer and screw
 - 1 (000812-25) Left-hand spindle assembly with seat washer and screw



B-12K B-1100 Spindle Parts Kit

- Included:
 - 1 (000800-25) Right-hand spindle assembly with seat washer and screw
 - 1 (000801-25) Left-hand spindle assembly with seat washer and screw



B-12K-T Same as B-12K except with teflon seat washers (001136-45)

B-13K Eterna Spring Check Spindle Assembly Kit

- Included:
 - 1 (001907-25) RH spindle insert
 - 1 (001908-25) LH spindle insert
 - 2 (003164-45) Seat washer – spring check
 - 2 (001479-45) Spring



012555-40 Wrist-Action Metering Cartridge Repair Kit

Included one (1) each:

- Bushing
- Spacer
- Linear cam
- Rotary cam
- Washer
- Return spring
- Grease pack

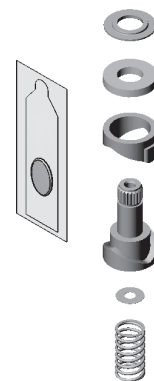

B-21K Eterna Replacement Parts Kit

- Included:
 - 1 (000788-20) Removable Eterna insert, Hot
 - 1 (000789-20) Removable Eterna insert, Cold
 - 2 (001022-45) Washers for inserts



Note: Some individual items listed in parts kits may be ordered separately. Contact our T&S factory Customer Service representatives for availability.

Parts and Repair Kits – Cartridges and Spindle Assemblies

B-23K Spring Check Spindle Assembly Replacements

Note: Kit supplied with components unassembled

- Parts included:
 - 2 (000607-40) Bonnet assembly
 - 2 (001466-20) Quarter-turn spindle sleeves
 - 1 (001908-25) Eterna spindle assembly (LH)
 - 1 (001907-25) Eterna spindle assembly (RH)
 - 2 (001479-45) Check spring
 - 2 (003164-45) Seat washer
 - 1 (000789-20) Removable insert Assembly (LH)
 - 1 (000788-20) Removable insert Assembly (RH)



B-238RK Push Button Metering Cartridge Repair Kit

Included one (1) each:

- (010150-45) Top washer
- (017182-45) Bottom seal filter washer
- (009391-45) 'O'-Ring
- (012596-45) Bottom stem seal

B-2800-WA-KIT Wrist-Action Metering Cartridge Kit

• Parts included:

- (2) Wrist-action metering cartridges with EasyInstall concealed widespread flanges, 4" wrist-action handles with screws and snap-in indexes

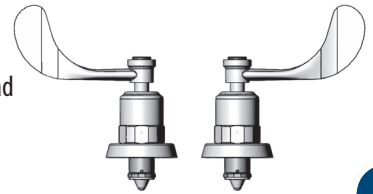

B-23K-NS New Style Spring Check Spindle Assembly Replacements

Note: Kit supplied with components unassembled

- Parts included:
 - 2 (000607-40NS) New style bonnet assembly
 - 2 (001466-20) Quarter-turn spindle sleeves
 - 1 (001908-25) Eterna spindle assembly (LH)
 - 1 (001907-25) Eterna spindle assembly (RH)
 - 2 (001479-45) Check spring
 - 2 (003164-45) Seat washer
 - 1 (000789-20) Removable insert assembly (LH)
 - 1 (000788-20) Removable insert assembly (RH)

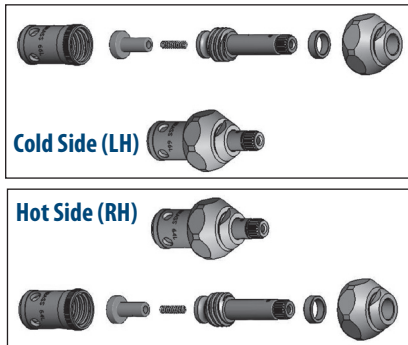

Parts and Repair Kits – Faucets

011643-45 Swivel Repair Kit



- Included:
 - 2 (011429-45) Swivel sleeves
 - 1 (001074-45) 'O'-Ring
 - 1 (011676-45) 'O'-Ring lubricant

017208-40 Concealed Widespread Faucet Diverter Repair Kit

Included one (1) each:

- Diverter and extension
- Center shank with swivel deck flange and flange nut
- Compression nut and fitting

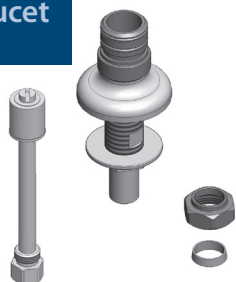

B-17K Old Style B-0230 Faucets Parts Kit

• Included:

- 1 (009194-25) Right-hand spindle
- 1 (009195-25) Left-hand spindle
- 2 (000933-45) Seat washer screw
- 2 (009649-45) Seat washer



B-30K Chinese Wok Wand Faucet Parts Kit

• Included:

- 1 (001625-45) Spring
- 4 (006562-45) 'O'-Ring
- 2 (009267-45) 'O'-Ring
- 2 (009268-45) 'O'-Ring
- 2 (001621-20) Bearing

Note: Some individual items listed in parts kits may be ordered separately. Contact T&S factory Customer Service representatives for availability.

Parts and Repair Kits – Faucets

B-2730-DRK Diverter Valve Replacement Kit

• Parts include:

- 1 Diverter valve stem
- 1 Diverter valve seal
- 2 Diverter valve 'O'-Rings
- 1 Diverter valve body
- 1 Diverter valve stem seal



B-9K Old Style Lever Handle Kit

• Lever handle kit includes:

- 1 (001661-45) Index button, red (hot)
- 1 (001660-45) Index button, blue (cold)
- 2 (000922-45) Lever handle screw
- 2 (001638-45) Lever handles, blank



B-9K-NS New Style Lever Handle Kit

• Lever handle kit includes:

- 1 (001193-19NS) New style index, red (hot)
- 1 (018506-19NS) New style index, blue (cold)
- 2 (000925-45) Lever handle screw
- 2 (001638-45NS) New style lever handles, blank



B-18KNS New Style Four Arm Handle Kit-Lab

• Parts included:

- 2 (002521-45NS) New style four arm handle
- 2 (000925-45) Handle screw
- 1 (001191-45NS) New style index, green – cold (CW)
- 1 (001194-45NS) New style index, red – hot (HW)



Parts and Replacement Kits – Handles

B-19K Old Style Four Arm Handle Kit – Kitchen

• Parts include:

- 2 (002521-45) Four arm handles
- 2 (000922-45) Handle screws
- 1 (001661-45) Index button, red (hot)
- 1 (001660-45) Index button, blue (cold)



B-19KNS New Style Four Arm Handle Kit – Kitchen

• Parts include:

- 2 (002521-45NS) New style four arm handles
- 2 (000925-45) Handle screws
- 1 (001193-19NS) New style index, red (hot)
- 1 (018506-19NS) New style index, blue (cold)

B-2K-NS New Style Wrist-Action Handle and Cartridge Parts Kit

• New style wrist-action handle and cartridge repair kit includes:

- 1 (000925-45) Handle screw
- 1 (018506-19NS) Cold index
- 1 (001193-19NS) Hot index
- 1 (003164-45) Spring check seat washer
- 1 (001479-45) Spring
- 1 (B-WH4-NS) New style 4" wrist-action handle

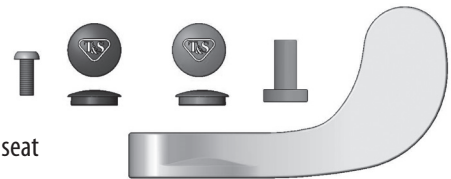

B-WH4-K Wrist-Action Handle and Quarter-Turn Eterna Parts Kit

• For B-WH4 handle:

- 2 (001466-20) Quarter-turn sleeve
- 2 (000925-45) Handle screw
- 2 (001136-45) Teflon seat washer
- 2 (000933-45) Seat washer screw
- 1 (001686-45) Index button, blue (cold)
- 1 (001194-45) Index button, red (hot)
- 2 B-WH4 4" Wrist-action handle

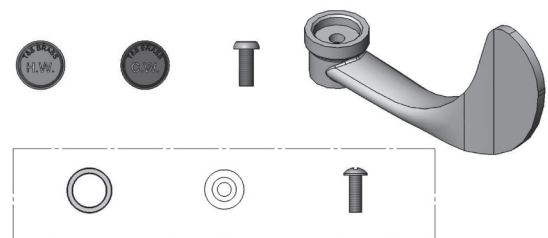

Note: Some individual items listed in parts kits may be ordered separately. Contact our T&S factory Customer Service representatives for availability.

Plumbing and Waste Valve – Parts and Repair Kits

B-50P Foot Pedal Valve Parts Kit

• Parts included:

- 4 (009306-20) Valve stem
- 4 (003690-45) Spring
- 4 (000974-45) Bonnet washer
- 4 (001040-45) Washer
- 4 (001100-45) Stem packing
- 4 (012915-45) B-0107 Seat washer (new style)
- 1 (012665-45) Silicon grease tube



B-39K Waste Valve Repair Kit

• Parts included:

- | | |
|--------------------------|-------------------------|
| 1 3-1/2" Head gasket | 1 Twist handle washer |
| 1 3" Head gasket | 1 Twist handle 'O'-Ring |
| 1 Plunger 'O'-Ring | 1 Twist handle 'C'-Ring |
| 1 Outlet coupling washer | 1 Rod nut 'O'-Ring |
| 1 Drain bushing | |

Parts Kits For Faucet Installation

EZ-K EasyInstall Retro-Fit Kit

Converts 3/8" NPT rigid to EasyInstall

Parts include one (1) each:

- EasyInstall nut
- EasyInstall bushing
- 'O'-Ring
- Lock washer
- Loctite capsule
- 3/8" Hex key

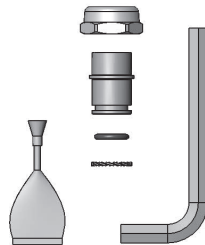

B-0230-K 1/2" NPT Male Elbow Installation Kit

- Includes two (2) each:
1/2" NPT Supply nipple,
lock nut and washer
1/2" NPT male x female
short EL

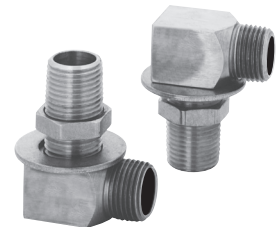

B-0230-KIT Inlet Parts Kit

Includes two (2) each:

- (017420-45) 24" flexible supply hoses
- (B-0230-K) 1/2" NPT male elbow installation kit



B-1100-K Parts Kit

Includes two (2) each:

- 1/2" NPT male x female short ELs

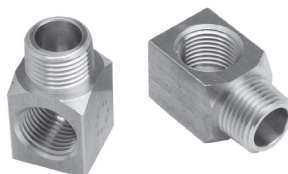

B-0230-K-M12 Master Pack of 12

B-1105-KIT Parts Kit

- Includes two (2) each:
(B-1100-K) 1/2" NPT Close elbows
(017420-45) 24" flexible supply hoses



Note: Some individual items listed in parts kits may be ordered separately. Contact our T&S factory Customer Service representatives for availability.

Repair Kits for Glass Fillers

B-1255 Repair Kit for Old Style Glass Filler

• Includes:

- 2 (001062-45) 'O'-Rings
- 2 (001094-45) Seat washers
- 2 (000894-45) Springs
- 1 (003199-45) Handle screw
- 2 (001100-45) Stem packings
- 1 (003198-45) Handle nut
- 1 (001145-45) Blue lever arm
- 2 (000974-45) Bonnet washers
- 1 (003090-45) Blue outlet
- 1 (012665-45) Silicon grease tube



B-1256 Repair Kit for New Style Glass Filler

• Includes:

- 1 (015588-40) Adjustable outlet with hex key
- 1 (015589-40) Valve assembly with valve spring
- 1 (015550-45) Lever arm repair kit with screw and nut



015589-40 Valve Assembly for New Style Glass Filler

• Includes:

- 1 Valve assembly, 3/4-20 UN threads
- 1 Stainless steel spring



015550-45 Lever Arm Repair Kit for New Style Glass Filler

• Includes:

- 1 Dark blue lever arm with screw and nut



G
10

Repair Kits for Vacuum Breakers

B-0963-RK Repair Kit

For B-0963 and includes:

Bonnet Repair Kit
with (1) each:

- Bonnet
- Bonnet 'O'-Ring
- Spring

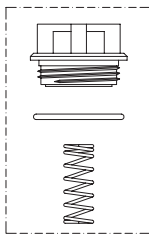

**Check Assembly
Repair Kit** with
(1) each:

- Spring
- 'O'-Ring
- Vent 'O'-Ring
- Check assembly
- Retainer
- Bleed screw
- 'O'-Ring

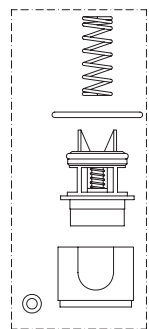

B-0968-RK01 Repair Kit

For B-0968 and includes:

- 2 Self-tapping screws
- 1 3/8" NPT vacuum breaker insert
- 1 Insert 'O'-ring
- 1 Piston 'O'-ring
- 1 3/8" NPT vacuum breaker piston

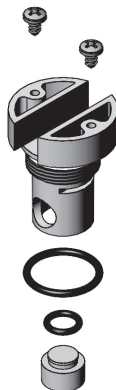

B-0969-RK01 Repair Kit

For B-0969 and includes:

- 2 Coverplate screws
- 2 Coverplate screws
- 1 Brass insert
- 1 Insert 'O'-ring
- 1 Disc seal
- 1 Float piston





RELIABILITY BUILT IN™

G-12

 Emergency Safety Equipment
by Haws

axion™

msr

medically superior response



axion™

msr

Introducing AXION MSR™ by Haws, the first and only eyewash and eye/face wash specifically designed to operate in concert with standard healthcare protocols and the natural function of the human eye.

In addition to the AXION MSR medical innovations, this exciting new patent-pending product has a number of features that set it apart from any other eyewash on the market:

- ***Inverted eyewash and eye/face wash streams***

AXION eyewash streams are inverted compared with the traditional eyewash. AXION streams contact the eyes at the inner canthus or corner, adjacent to the bridge of the nose. Contaminants are then swept to the outer edge of the eye, where gravity takes over and runs them into the eyewash bowl.

- ***Laminar flow eyewash streams for greater stream consistency***

Another first is the use of laminar flow engineering in the eyewash streams. In simple terms, a laminar flow is one in which there is an absence of turbulence, because the stream is “built” in layers. The result? An even, comfortable, predictable stream height and circumference.

- ***“Zero vertical velocity” engineering for maximum victim comfort***

Next, because AXION eyewash streams are almost vertically oriented, they “stall” at a prescribed height. When the stream exhausts its vertical velocity, it softly turns outward and begins to fall off horizontally. This action causes a slight puddling of the flow in midair before it returns to the eyewash bowl. It occurs directly at the optimal contact point with the eye, making for a more pleasant and effective irrigation experience.



The medically superior response

The medical profession teaches and practices irrigating eyes by introducing flushing fluid at the inner corner of the eye – adjacent to the nose – letting it run across the eye to the outer edge. This is specifically done to avoid driving contaminants into the lacrimal punctum and the nasal cavity. The accepted medical practice is counter to the way that traditional eyewashes operate and can result in further injury to the splash or blown-particulate injured victim. Axion MSR is the only eyewash product that duplicates the methodology used by and recommended by healthcare professionals.

Ophthalmologist Robert S. Wolff, MD



H
3



Emergency Safety Equipment by Haws For Immediate On-The-Job Eye Safety

Why do you need to consider installing an eyewash station in your facility? Since OSHA does not require eyewash stations by industry, the need for an eyewash station should be determined by the chemicals that are used in an establishment. Wherever corrosive chemicals are being used, an eyewash station is very important for employee safety and health.

If corrosive chemicals are being used, an eyewash station is very important for employee safety and health.

EW-7360B Wall Mounted Eye/Face Wash

- ABS green plastic eyewash head with built-in 2.5 GPM flow control
- Integral flip top dust cover
- Round stainless steel receptor with chrome plated brass stay open ball valve, 1/2" NPT inlet and outlet, 1/4" NPT waste
- Universal emergency eyewash sign
- Includes "Test This Week" tag to record weekly testing record of emergency equipment



EW-7360B

EW-7501 Nine Gallon Gravity Fed Portable Eyewash Unit

- Nine gallon capacity, high-density green polyethylene tank provides full pattern flushing at .4 GPM for a full 15 minutes
- Fold down eyewash arm has positive upper limit stop that covers and protects spray outlets when not in use
- Wide-fill opening for easy inspection, cleaning and filling
- ABS plastic eyewash heads with tripod anchor, stainless steel socket head cap screw and rubber gasket
- Includes wall bracket
- Eyewash preservative sold separately (EW-9082)
Note: Unit must be wall hung



EW-7501

EW-9082



Accessories:

EW-9082 Bacteriostatic preservative, four bottles per carton. One 5 oz. bottle preserves five to 20 gallons of water for up to three months.

EW-7611 Countertop Mounted Pull Down Eye/Face Wash Unit

- Polished chrome plated brass eye/face wash swings forward to activate
- ABS green plastic head with built in 2.5 GPM flow control
- Integral flip top dust cover
- Can be mounted on either right or left side of sink
- Supply: 1/2" O.D. slip joint
- Universal emergency eyewash sign
- Includes "Test This Week" tag to record weekly testing record of emergency equipment

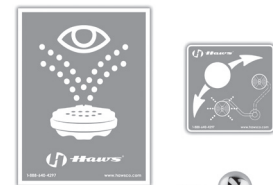

EW-7611

EW-7612 Swing Away Eyewash Unit

- Countertop mounted polished chrome plated brass eye/face wash unit with swing-away feature to activate
- Mounted on right side of sink
- Polyethylene dust cover
- Supply: 1/2" O.D. slip joint
- Universal emergency eyewash sign
- "Test This Week" tag to record weekly testing record of equipment



EW-7612

EW-7612LH Swing Away Eyewash Unit

- Same as EW-7612 except mounted on left side of sink



EW-7612LH

T&S Emergency Equipment by Haws offers you the simple solution to respond appropriately. Our eye and face wash stations can be used in industrial and foodservice applications, where clean-up personnel and others come in contact with corrosive chemicals.

- Certified in the U.S. to meet ANSI Z358.1 Standard for Emergency Eyewash and Shower Equipment
- Certified by CE and CSA in Europe and Canada
- All products tested before shipping
- Quick-Ship next day shipping available

EW-7360B-TMV Wall Mounted Eye/Face Wash Unit

- ABS green plastic eyewash head with laminar flow
- Integral flip top dust cover
- Round stainless steel receptor with chrome plated brass stay open ball valve, 1/2" NPT inlet, 1-1/4" NPT waste
- Thermostatic mixing valve



EW-8904 Counter Mounted Laboratory Eye/Face Wash Unit

- Countertop mounted eye/face and body spray
- Head positioned at 45° angle
- Stay open squeeze lever valve
- 8 ft. swivel hose with 1/2" NPT inlet and deck flange that incorporates guiding key slot for proper positioning of spray
- Universal emergency eyewash sign
- "Test This Week" tag to record weekly testing record of equipment



EW-9201EF Tempered Water Blending Valve

- Thermostatic mixing valve supplies tempered water to fixtures with flow from 1 to 12 GPM, sufficient for one or two eye/face wash units
- Includes thermostatic mixing element and outlet temperature gauge
- Fail-safe back up ensures shut-off of incoming hot water if cold water fails or is interrupted; valve goes into cold water bypass mode
- Maintains outlet temperature to within +/- 5°F (2.5°C) with as little as 2 GPM water flow
- Outlet temperature factory setting: 80°F (26°C)
- Maximum inlet pressure: 125 PSI
- Maximum inlet temperature: 180°F (82°C); recommended: 140°F; minimum temperature 120°F
- 1/2" NPT inlet and 3/4" NPT outlet
- Supplied with check valves

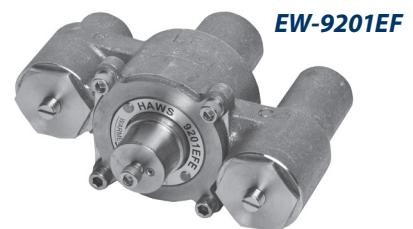

EW-9095 Eyewash Sprayhead Covers (only)

- Eyewash sprayhead covers protect eyewash orifices when not in use
- Ring end installed on eyewash frame (as shown) with covers bent over to cover the opposite eyewash orifice



EW-9095 (installed)

For Eyewash replacement parts, see next page

Emergency Safety Equipment by Haws – Replacement Parts

EW-SP21FC ABS Plastic Head

- Safety green eye/face wash head with built-in 2.5 GPM automatic pressure compensation flow control
- Assures soft, steady stream of water from 30 to 90 PSI
- Integral flip top dust covers automatically release with flow of water
- ¼" IPS supply



EW-SP21FC

EW-SP90 Stainless Steel Receptor

- Round 11" stainless steel receptor for model EW-7360B



EW-SP90

EW-SP131 Cap

- Threaded cap for model EW-7501



EW-SP131

EW-SP140 8' Hose

- 250 PSI hose with chrome plated swivel fitting at one end for ease of operation
- For model EW-8904



EW-SP140

EW-SP170 Safety Test Cards

- "Test This Week" cards with space to permanently record date and initials of inspector, to record weekly safety testing
- Printed on waterproof stock, comes with beaded ties
- Package of 25



EW-SP170

EW-SP225 Stainless Steel Push Flag

- Stainless steel push flag operates stay-open chrome plated brass ball eyewash valve
- Stainless steel ball and stem
- ¼" NPT female inlet and ¼" NPT female outlet

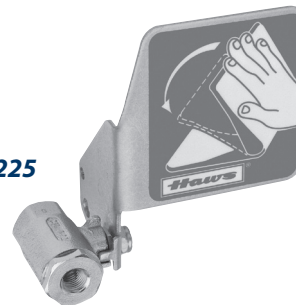

EW-SP225

EW-SP509 In-Line Mesh Strainer

- Fully serviceable 50 x 50 mesh strainer filters debris from reaching the eye or eye/face wash
- ½" x ¼" strainer, 90°
- ½" slip-joint nut and washers (not shown) for connecting to combination shower and eyewash units
- For model EW-7360B



EW-SP509





RELIABILITY BUILT IN™

G-12
1 Equip



Equip Plumbing Products – I

Equip Electronic Faucets I3-4

NEW MODELS!

- Deck Mount Electronic Faucets
- Wall Mount Electronic Faucets

Equip Pre-Rinse Units I5-9

- 4" Deck Mount Pre-Rinses I5
- Single Hole Deck Mount Pre-Rinses I6
- 8" Wall Mount Pre-Rinses I7
- 8" Deck Mount Pre-Rinses I8
- Single Supply Deck Mount Pre-Rinses I9

Equip Faucets I11-21

- Single Supply Deck Mount Faucets I11
- 4" Deck Mount Workboard Faucets I12
- 4" Deck Mount Faucets I13-14
- Single Hole Deck Mount Faucets I15
- 4" Wall Mount Workboard Faucets I16
- 8" Wall Mount Faucets I17-18
- 8" Deck Mount Workboard Faucets I18
- 8" Deck Mount Faucets I19-20
- Centerset Single Lever Deck Mount Faucet I21

Equip Glass Fillers I21

- Wall Mount and Deck Mount Glass Fillers
- Glass Filler/Water Station

Equip Hose Reels I22-27

- Open Hose Reels/Parts I22-24
- Complete Hose Reel Systems with with Model Key / Models I26-27
- Spray Valve and Water Gun Options I22, 24, 27

Equip Accessories I28-30

- Pre-Rinse Accessories, Handles, Inlet Kits, Add-On Faucets, Spray Valves, Water Guns, Spray Valves, Spring, Hose, Cartridges I28-29
- Swing Nozzles and Swivel and Rigid Goosenecks I30

NOTE:
A comprehensive Index By Model or Part Number and Page can be found in the G-12 General Product Catalog Master Index section (IN).

? Can't find the equip product you're looking for?
Visit www.tsbrass.com for a complete product listing.



5EF-1D-DG Series Electronic Faucets

- Single hole deck-mount sensor faucet
- Rigid gooseneck with 2.2 GPM vandal-resistant aerator
- AC or DC powered control module
- Temperature control mixing valve



5EF-1D-DG

5EF-1D-WG Series Electronic Faucets

- Single hole wall-mount sensor faucet
- Rigid gooseneck with 2.2 GPM vandal-resistant aerator
- AC or DC powered control module
- Temperature control mixing valve



5EF-1D-WG

MODEL	Wall or Deck Mount	Gooseneck	Aerator / GPM	Supply Nipple	Notes
5EF-1D-DG Models					
5EF-1D-DG	Deck	5-11/16" rigid	B-0199-06 VR 2.2 GPM	N	
5EF-1D-DG-4DP	Deck	5-11/16" rigid	B-0199-06 VR 2.2 GPM	N	4" c/c deckplate
5EF-1D-DG-4DPWS	Deck	5-11/16" rigid	B-0199-06-WS VR 1.5 GPM	N	4" c/c deckplate
5EF-1D-DG-TMV	Deck	5-11/16" rigid	B-0199-06 VR 2.2 GPM	N	Thermostatic mixing valve
5EF-1D-DG-VF05	Deck	5-11/16" rigid	B-0199-06-N05 VR 0.5 GPM	N	
5EF-1D-DG-V5-HG	Deck	5-11/16" rigid	B-0199-06-N05 VR 0.5 GPM	N	Low flow hydrogenerator
5EF-1D-DG-V5THG	Deck	5-11/16" rigid	B-0199-06-N05 VR 0.5 GPM	N	Thermostatic mixing valve; Low flow hydrogenerator
5EF-1D-DG-WS	Deck	5-11/16" rigid	B-0199-06-WS VR 1.5 GPM	N	
5EF-1D-WG Models					
5EF-1D-WG	Wall	6-3/8" rigid	B-0199-06 VR 2.2 GPM	N	Short el
5EF-1D-WG-TMV	Wall	6-3/8" rigid	B-0199-06 VR 2.2 GPM	N	Thermostatic mixing valve
5EF-1D-WG-VF05	Wall	6-3/8" rigid	B-0199-06-N05 VR 0.5 GPM	N	

Electronic Faucets Replacement Parts

- 5EF-0001 Control module
- 5EF-0002 AC transformer
- 5EF-0003 Flat lens and sensor wire assembly
- 5EF-0004 Convex lens and sensor wire assembly
- 5EF-0005 Flexible supply hose for 3/8" compression stops
- 5EF-0006 Electronic faucet mixing valve
- 5EF-FILTER Electronic faucet control module filter
- 5EF-TMV Thermostatic mixing valve with 1/2" NPSM male fittings

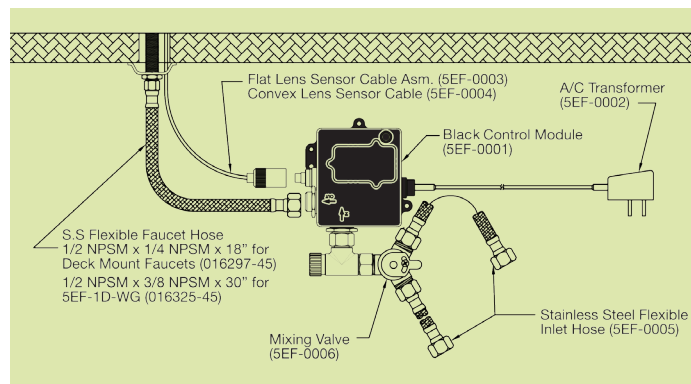



5EF-1D-DS Series Electronic Faucet

- Single hole deck mount sensor faucet
- Cast spout with 2.2 GPM vandal-resistant aerator
- AC or DC powered control module
- Temperature control mixing valve



5EF-1D-DS

MODEL	Wall or Deck Mount	Gooseneck	Aerator / GPM	Supply Nipple	Notes
5EF-1D-DS Models					
5EF-1D-DS	Deck	4-9/16" Cast spout	B-0199-09 VR 2.2 GPM	N	
5EF-1D-DS-4DP	Deck	4-9/16" Cast spout	B-0199-09 VR 2.2 GPM	N	4" c/c deckplate
5EF-1D-DS-TMV	Deck	4-9/16" Cast spout	B-0199-09 VR 2.2 GPM	N	Thermostatic mixing valve
5EF-1D-DS-V5-HG	Deck	4-9/16" Cast spout	B-0199-09-N05 VR 0.5 GPM	N	Low flow hydrogenerator
5EF-1D-DS-V5THG	Deck	4-9/16" Cast spout	B-0199-09-N05 VR 0.5 GPM	N	Thermostatic mixing valve; Low flow hydrogenerator
5EF-1D-DS-VF05	Deck	4-9/16" Cast spout	B-0199-09-N05 VR 0.5 GPM	N	

5EF-2D-DS Series Electronic Faucet

- 4" centerset deck mount sensor faucet
- Cast spout with 2.2 GPM vandal-resistant aerator
- AC or DC powered control module
- Temperature control mixing valve



5EF-2D-DS

MODEL	Wall or Deck Mount	Gooseneck	Aerator / GPM	Supply Nipple	Notes
5EF-2D-DS Models					
5EF-2D-DS	Deck	5-3/16" Cast spout	B-0199-09 VR 2.2 GPM	N	Short el
5EF-2D-DS-TMV	Deck	5-3/16" Cast spout	B-0199-09 VR 2.2 GPM	N	Thermostatic mixing valve
5EF-2D-DS-VF05	Deck	5-3/16" Cast spout	B-0199-09-N05 VR 0.5 GPM	N	
5EF-2D-DS-V5-HG	Deck	5-3/16" Cast spout	B-0199-09-N05 VR 0.5 GPM	N	Low flow hydrogenerator
5EF-2D-DS-V5THG	Deck	5-3/16" Cast spout	B-0199-09-N05 VR 0.5 GPM	N	Thermostatic mixing valve; Low flow hydrogenerator
5EF-2D-DS-WS	Deck	5-3/16" Cast spout	B-0199-09-WS VR 1.5 GPM	N	



Electronic Faucets Replacement Parts

- 5EF-0001 Control module
- 5EF-0002 AC transformer
- 5EF-0003 Flat lens and sensor wire assembly
- 5EF-0004 Convex lens and sensor wire assembly
- 5EF-0005 Flexible supply hose for 3/8" compression stops
- 5EF-0006 Electronic faucet mixing valve
- 5EF-FILTER Electronic faucet control module filter
- 5EF-TMV Thermostatic mixing valve with 1/2" NPSM male fittings

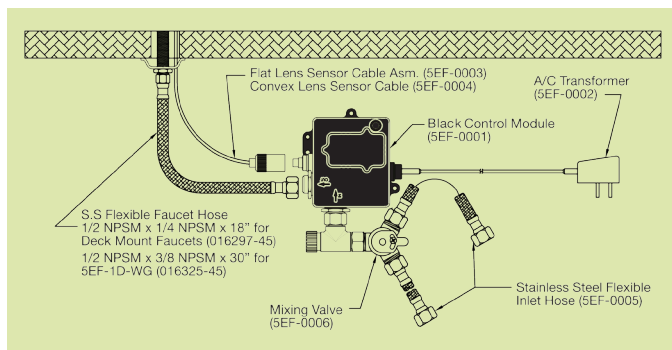

4" Deck Mount Pre-Rinse Units

- 4" deck mount mixing faucet
- In-line check valves
- Quarter-turn ceramic cartridges with lever handles and color coded screws
- ½" NPT eccentric flanged female inlets
- 44" flex hose with overhead spring
- 5SV 1.15 GPM spray valve
- Includes 6" wall bracket

MODEL	Spray Valve / GPM	Add-On Faucet	Nozzle Length / Outlet	Supply Nipples	Notes
4" Deck Mount Faucet Models					
5PR-4D00	5SV (1.15 GPM)	N	–	N	
5PR-4D08	5SV (1.15 GPM)	Y	8" with Laminar flow	N	
5PR-4D12	5SV (1.15 GPM)	Y	12" with Laminar flow	N	
5PR-4DLS00	5SV (1.15 GPM)	N	–	Y	Includes supply nipple kit B-0425-M
5PR-4DLS08	5SV (1.15 GPM)	Y	8" with Laminar flow	Y	Includes supply nipple kit B-0425-M



5PR-4D00



5PR-4D12

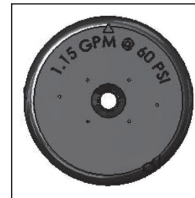

2019 DOE Compliant equip Spray Face

2019 DOE Compliant

Single Hole Deck Mount Pre-Rinse Units

- Single hole deck mount mixing faucet
- 1/2" BSPP in-line check valves
- Quarter-turn ceramic cartridges with lever handles and color coded screws
- 18" flexible supply hoses
- 44" flex hose with overhead spring
- 5SV 1.15 GPM spray valve
- Includes 6" wall bracket

MODEL	Spray Valve	Add-On Faucet	Nozzle Length / Outlet	Supply Nipples	Notes
Single Hole Dual Temp Models					
5PR-2S00	5SV (1.15 GPM)	N	—	N	
5PR-2S00-12WB	5SV (1.15 GPM)	N	—	N	12" Wall Bracket
5PR-2S00-C	5SV-C (1.2 GPM)	N	—	N	
5PR-2S06	5SV (1.15 GPM)	Y	6" with Laminar flow	N	
5PR-2S08	5SV (1.15 GPM)	Y	8" with Laminar flow	N	
5PR-2S10	5SV (1.15 GPM)	Y	10" with Laminar flow	N	
5PR-2S12	5SV (1.15 GPM)	Y	12" with Laminar flow	N	
5PR-2S12-C	5SV-C (1.2 GPM)	Y	12" with Laminar flow	N	
5PR-2S14	5SV (1.15 GPM)	Y	14" with Laminar flow	N	



5PR-2S00



5PR-2S12

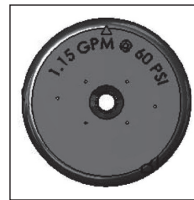

2019 DOE Compliant equip Spray Face

2019 DOE Compliant

8" Wall Mount Pre-Rinse Units

- 8" wall mount mixing faucet
- In-line check valves
- 1/2" NPT female inlets
- Quarter-turn ceramic cartridges with lever handles and color coded screws
- 44" flex hose with overhead spring
- 5SV 1.15 GPM spray valve
- Includes 6" wall bracket



5PR-8W00



5PR-8W12



5PR-8W00-C



5PR-8WWS12

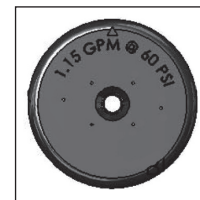

2019 DOE Compliant equip Spray Face

2019 DOE Compliant

MODEL	Spray Valve	Add-On Faucet	Nozzle Length / Outlet	Supply Nipples	Notes
8" Wall Mount Pre-Rinse Models					
5PR-8W00	5SV (1.15 GPM)	N	—	N	
5PR-8W00-C	5SV-C (1.2 GPM)	N	—	N	
5PR-8W06	5SV (1.15 GPM)	Y	6" with Laminar flow	N	
5PR-8W08	5SV (1.15 GPM)	Y	8" with Laminar flow	N	
5PR-8W10	5SV (1.15 GPM)	Y	10" with Laminar flow	N	
5PR-8W12	5SV (1.15 GPM)	Y	12" with Laminar flow	N	
5PR-8W12-C	5SV-C (1.2 GPM)	Y	12" with Laminar flow	N	
5PR-8W14	5SV (1.15 GPM)	Y	14" with Laminar flow	N	
5PR-8W14-C	5SV-C (1.2 GPM)	Y	14" with Laminar flow	N	
5PR-8W18	5SV (1.15 GPM)	Y	18" with Laminar flow	N	
8" Wall Mount Pre-Rinse Models with Elbow Kits					
8PR-8WLS00	5SV (1.15 GPM)	N	—	Y	Includes 1/2" NPT male elbow kit (B-0230-K)
8PR-8WLS12	5SV (1.15 GPM)	Y	12" with Laminar flow	Y	Includes 1/2" NPT male elbow kit (B-0230-K)
8PR-8WWS00	5SV (1.15 GPM)	N	—	Y	4" Wrist-action handles; includes 1/2" NPT male elbow kit (B-0230-K)
8PR-8WWS12	5SV (1.15 GPM)	Y	12" with Laminar flow	Y	4" Wrist-action handles; includes 1/2" NPT male elbow kit (B-0230-K)

8" Deck Mount Pre-Rinse Units

- 8" deck mount mixing faucet
- In-line check valves
- Quarter-turn ceramic cartridges with lever handles and color coded screws
- ½" NPT female inlets
- 44" flex hose with overhead spring
- 5SV 1.15 GPM spray valve
- Includes 6" wall bracket

Note: ½" NPT supply nipple kit (B-0425-M) sold separately

MODEL	Spray Valve	Add-On Faucet	Nozzle Length / Outlet	Supply Nipples	Notes
8" Deck Mount Pre-Rinse Models					
5PR-8D00	5SV (1.15 GPM)	N	–	N	
5PR-8D06	5SV (1.15 GPM)	Y	6" with Laminar flow	N	
5PR-8D08	5SV (1.15 GPM)	Y	8" with Laminar flow	N	
5PR-8D10	5SV (1.15 GPM)	Y	10" with Laminar flow	N	
5PR-8D12	5SV (1.15 GPM)	Y	12" with Laminar flow	N	



5PR-8D00



5PR-8D12

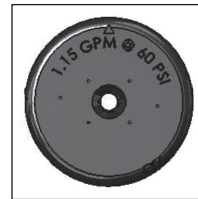

2019 DOE Compliant equip
Spray Face

2019 DOE Compliant

Single Supply Deck Mount Pre-Rinse Units

- Single hole, single temperature deck mount faucet
- Quarter-turn ceramic cartridge with lever handle and color coded screw
- ½" NPSM female inlet
- 44" flex hose with overhead spring
- 5SV 1.15 GPM spray valve
- Includes 6" wall bracket

MODEL	Spray Valve	Add-On Faucet	Nozzle Length / Outlet	Supply Nipples	Notes
Single Hole Single Temp Pre-Rinse Models					
5PR-1S00	5SV (1.15 GPM)	N	—	N	
5PR-1S06	5SV (1.15 GPM)	Y	6" with Laminar flow	N	
5PR-1S08	5SV (1.15 GPM)	Y	8" with Laminar flow	N	
5PR-1S10	5SV (1.15 GPM)	Y	10" with Laminar flow	N	
5PR-1S12	5SV (1.15 GPM)	Y	12" with Laminar flow	N	
5PR-1S14	5SV (1.15 GPM)	Y	14" with Laminar flow	N	
5PR-1S18	5SV (1.15 GPM)	Y	18" with Laminar flow	N	



5PR-1S00



5PR-1S12

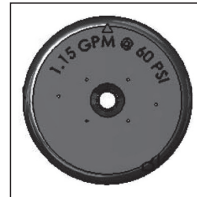

2019 DOE Compliant equip Spray Face

2019 DOE Compliant

Lined area for notes



Single Supply Deck Mount Faucets

- Single hole, single temperature deck mount faucet
- Converts to rigid from swivel with included lock washer (014200-45)
- Quarter-turn ceramic cartridge with lever handle and color coded screw
- 1/2" NPSM male inlet



MODEL	Swing Nozzle / Goosneck	Aerator / GPM	Supply Nipple	Notes
Single Supply Deck Mount Faucet Models				
5F-1SLX00	—	—	N	Less swing nozzle
5F-1SLX03	3" Rigid goosneck	Laminar flow	N	
5F-1SLX05	5-1/2" Rigid/Swivel goosneck	Laminar flow	N	See photo, left
5F-1SLX05A	5-1/2" Rigid/Swivel goosneck	2.2 GPM Aerator	N	
5F-1SLX05CA	5-7/8" Rigid/Swivel goosneck	2.2 GPM Aerator	N	
5F-1SLX06	6" Swing nozzle	Laminar flow	N	
5F-1SLX08	8" Swing nozzle	Laminar flow	N	
5F-1SLX08A	8" Swing nozzle	2.2 GPM Aerator	N	
5F-1SLX10	8" Swing nozzle	Laminar flow	N	
5F-1SLX10A	10" Swing nozzle	2.2 GPM Aerator	N	
5F-1SLX12	12" Swing nozzle	Laminar flow	N	See photo, left
5F-1SLX12A	12" Swing nozzle	2.2 GPM Aerator	N	
5F-1SLX14	14" Swing nozzle	Laminar flow	N	
5F-1SLX18	18" Swing nozzle	Laminar flow	N	

Certified to NSF/ANSI 61/9

Single Supply Wall Mount Faucets

- Single hole, single temperature wall mount faucet
- 5-9/16" swivel goosneck with laminar flow device
- Quarter-turn ceramic cartridge with lever handle and color coded screw
- 1/2" NPT female inlet

Note: Converts to rigid from swivel with lock washer (014200-45) sold separately



MODEL	Swing Nozzle / Goosneck	Aerator / GPM	Supply Nipple	Notes
Single Supply Wall Mount Faucet Models				
5F-1WLX05	5-9/16" Rigid/Swivel goosneck	Laminar flow	N	See photo, left
5F-1WLX00	—	—	N	Less nozzle

Certified to NSF/ANSI 61/9





4" Deck Mount Workboard Faucets

- 4" deck mount mixing faucet
- Quarter-turn ceramic cartridges with lever handles with color coded screws

Note: Converts to rigid with (014200-45) lock washer (sold separately)



5F-4CLX12

5F-4CLX05

MODEL	Swing Nozzle / Goosneck	Aerator / GPM	Supply Nipple	Notes
4" Deck Mount Workboard Faucet Models				
5F-4CLX00	–	–	N	Less swing nozzle
5F-4CLX03A	3" Swivel goosneck	2.2 GPM Aerator	N	
5F-4CLX05	5-1/2" Swivel goosneck	Laminar flow	N	See photo, left
5F-4CLX06	6" Swing nozzle	Laminar flow	N	
5F-4CLX08	8" Swing nozzle	Laminar flow	N	
5F-4CLX10	10" Swing nozzle	Laminar flow	N	
5F-4CLX12	12" Swing nozzle	Laminar flow	N	See photo, left

Certified to NSF/ANSI 61/9

4" Deck Mount Workboard Faucets

- 4" deck mount mixing faucet
- Quarter-turn ceramic cartridges with 4" wrist- action handles and color coded screws

Note: Converts to rigid with (014200-45) lock washer (sold separately)



5F-4CWX12

5F-4CWX03A



MODEL	Swing Nozzle / Goosneck	Aerator / GPM	Supply Nipple	Notes
4" Deck Mount Workboard Faucets with Wrist-Action Handles				
5F-4CWX00	–	–	N	Less swing nozzle
5F-4CWX03A	3" Swivel goosneck	2.2 GPM Aerator	N	See photo, left
5F-4CWX05	5-1/2" Swivel goosneck	Laminar flow	N	
5F-4CWX05A	5-1/2" Swivel goosneck	2.2 GPM Aerator	N	
5F-4CWX06	6" Swing nozzle	Laminar flow	N	
5F-4CWX08	8" Swing nozzle	Laminar flow	N	
5F-4CWX10	10" Swing nozzle	Laminar flow	N	
5F-4CWX12	12" Swing nozzle	Laminar flow	N	See photo, left

Certified to NSF/ANSI 61/9



4" Deck Mount Faucets

- 4" deck mount mixing faucet
- Ceramic cartridges with lever handles with color coded screws
- ½" NPT female inlets

Note: Converts to rigid with (014200-45) lock washer (sold separately)



5F-4DLX12



5F-4DLX05



B-0425-M

MODEL	Swing Nozzle / Goosneck	Aerator / GPM	Supply Nipple	Notes
4" Deck Mount Faucet Models				
5F-4DLX00	—	—	N	Less swing nozzle
5F-4DLX03	3" Rigid gooseneck	Laminar flow	N	
5F-4DLX05	5-1/2" Swivel gooseneck	Laminar flow	N	See photo, left
5F-4DLX06	6" Swing nozzle	Laminar flow	N	
5F-4DLX08	8" Swing nozzle	Laminar flow	N	
5F-4DLX10	10" Swing nozzle	Laminar flow	N	
5F-4DLX12	12" Swing nozzle	Laminar flow	N	See photo, left
5F-4DLX14	14" Swing nozzle	Laminar flow	N	
4" Deck Mount Faucets with Inlet Supply Kits				
5F-4DLS00	—	—	Y	Less swing nozzle
5F-4DLS03	3" Rigid gooseneck	Laminar flow	Y	Includes inlet supply kit (B-0425-M)
5F-4DLS05	5-1/2" Swivel gooseneck	Laminar flow	Y	Includes inlet supply kit (B-0425-M)
5F-4DLS05A	5-1/2" Swivel gooseneck	2.2 GPM Aerator	Y	Includes inlet supply kit (B-0425-M)
5F-4DLS05CA	5-7/8" Swivel gooseneck	2.2 GPM Aerator	Y	Includes inlet supply kit (B-0425-M)
5F-4DLS06	6" Swing nozzle	Laminar flow	Y	Includes inlet supply kit (B-0425-M)
5F-4DLS08	8" Swing nozzle	Laminar flow	Y	Includes inlet supply kit (B-0425-M)
5F-4DLS08A	8" Swing nozzle	2.2 GPM Aerator	Y	Includes inlet supply kit (B-0425-M)
5F-4DLS09	9" Swivel gooseneck	Laminar flow	Y	Includes inlet supply kit (B-0425-M)
5F-4DLS10	10" Swing nozzle	Laminar flow	Y	Includes inlet supply kit (B-0425-M)
5F-4DLS10A	10" Swing nozzle	2.2 GPM Aerator	Y	Includes inlet supply kit (B-0425-M)
5F-4DLS12	12" Swing nozzle	Laminar flow	Y	Includes inlet supply kit (B-0425-M)
5F-4DLS12A	12" Swing nozzle	2.2 GPM Aerator	Y	Includes inlet supply kit (B-0425-M)
5F-4DLS14	14" Swing nozzle	Laminar flow	Y	Includes inlet supply kit (B-0425-M)

Certified to NSF/ANSI 61/9



4" Deck Mount Faucets with Wrist-Action Handles

- 4" deck mount mixing faucet
- Quarter-turn ceramic cartridges with 4" wrist-action handles and color coded screws

Note: Converts to rigid with (014200-45) lock washer (sold separately)



5F-4DWX12



B-0425-M



5F-4DWS09

MODEL	Swing Nozzle / Goosneck	Aerator / GPM	Supply Nipple	Notes
4" Deck Mount Faucets with Wrist-Action Handles				
5F-4DWX00	—	—	N	Less swing nozzle
5F-4DWX08	8" Swing nozzle	Laminar flow	N	
5F-4DWX10	10" Swing nozzle	Laminar flow	N	
5F-4DWX12	12" Swing nozzle	Laminar flow	N	See photo, left
4" Deck Mount Faucets with Wrist-Action Handles and Inlet Supply Kits				
5F-4DWS00	—	—	Y	Less swing nozzle; includes supply kit (B-0425-M)
5F-4DWS03	3" Rigid goosneck	Laminar flow	Y	Includes supply kit (B-0425-M)
5F-4DWS05	5-1/2" Swivel goosneck	Laminar flow	Y	Includes supply kit (B-0425-M)
5F-4DWS06	6" Swing nozzle	Laminar flow	Y	Includes supply kit (B-0425-M)
5F-4DWS08	8" Swing nozzle	Laminar flow	Y	Includes supply kit (B-0425-M)
5F-4DWS09	9" Swivel goosneck	Laminar flow	Y	Includes supply kit (B-0425-M)
5F-4DWS10	10" Swing nozzle	Laminar flow	Y	Includes supply kit (B-0425-M)
5F-4DWS12	12" Swing nozzle	Laminar flow	Y	Includes supply kit (B-0425-M)
5F-4DWS14	14" Swing nozzle	Laminar flow	Y	Includes supply kit (B-0425-M)

Certified to NSF/ANSI 61/9



Single Hole Deck Mount Faucets

- Single hole deck mount faucet
- Ceramic cartridge with lever handles with color coded screws
- 18" flexible supply hoses with compression fittings for 5/8" O.D. copper tubing
- Remove compression nut for 1/2" NPSM male inlet

Note: Converts to rigid with (014200-45) lock washer (sold separately)



MODEL	Swing Nozzle / Goosneck	Aerator / GPM	Notes
Single Hole Deck Mount Faucet Models			
5F-2SLX00	–	–	Less swing nozzle
5F-2SLX03	3" Rigid goosneck	Laminar flow	
5F-2SLX05	5-1/2" Swivel goosneck	Laminar flow	See photo, left
5F-2SLX05A	5-1/2" Swivel goosneck	2.2 GPM Aerator	
5F-2SLX05CA	5-7/8" Swivel goosneck	2.2 GPM Aerator	
5F-2SLX06	6" Swing nozzle	Laminar flow	
5F-2SLX08	8" Swing nozzle	Laminar flow	
5F-2SLX08A	8" Swing nozzle	2.2 GPM Aerator	
5F-2SLX10	10" Swing nozzle	Laminar flow	
5F-2SLX10A	10" Swing nozzle	2.2 GPM Aerator	
5F-2SLX12	12" Swing nozzle	Laminar flow	See photo, left
5F-2SLX12A	12" Swing nozzle	2.2 GPM Aerator	
5F-2SLX14	14" Swing nozzle	Laminar flow	
5F-2SLX18	18" Swing nozzle	Laminar flow	

Certified to NSF/ANSI 61/9



4" Wall Mount Workboard Faucets

- 4" wall mount mixing faucet
- Quarter-turn ceramic cartridges with lever handles and color coded screws
- 1/2" NPT male inlets

Note: Converts to rigid with (014200-45) lock washer (sold separately)



5F-4WLX12



5F-4WLX03

MODEL	Swing Nozzle / Goosneck	Aerator / GPM	Supply Nipple	Notes
4" Deck Mount Workboard Faucet Models				
5F-4WLX00	—	—	N	Less swing nozzle
5F-4WLX03	3" Swivel goosneck	Laminar flow	N	See photo, left
5F-4WLX03-VF05	3" Swivel goosneck	0.5 GPM VR Non-aerated outlet device	N	
5F-4WLX05	5-1/2" Swivel goosneck	Laminar flow	N	
5F-4WLX06	6" Swing nozzle	Laminar flow	N	
5F-4WLX08	8" Swing nozzle	Laminar flow	N	
5F-4WLX10	10" Swing nozzle	Laminar flow	N	
5F-4WLX12	12" Swing nozzle	Laminar flow	N	See photo, left

Certified to NSF/ANSI 61/9

4" Wall Mount Workboard Faucets with Wrist-Action Handles

- 4" wall mount mixing faucet
- Quarter-turn ceramic cartridges with wrist-action handles and color coded screws
- 1/2" NPT male inlets

Note: Converts to rigid with (014200-45) lock washer (sold separately)



4" Deck Mount Workboard Faucets with Wrist-Action Handles				
5F-4WWX00	—	—	N	Less swing nozzle
5F-4WWX03	3" Swivel goosneck	Laminar flow	N	See photo, left
5F-4WWX05	5-1/2" Swivel goosneck	Laminar flow	N	See photo, left
5F-4WWX06	6" Swing nozzle	Laminar flow	N	
5F-4WWX08	8" Swing nozzle	Laminar flow	N	
5F-4WWX10	10" Swing nozzle	Laminar flow	N	
5F-4WWX12	12" Swing nozzle	Laminar flow	N	

Certified to NSF/ANSI 61/9

I 16



5F-4WWX05



5F-4WWX03



8" Wall Mount Faucets

- 8" wall mount mixing faucet
- Quarter-turn ceramic cartridges with lever handles with color coded screws
- 1/2" NPT female inlets

Note: Converts to rigid with (014200-45) lock washer (sold separately)



5F-8WLX12

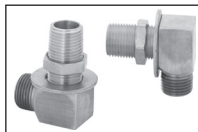

B-0230-K



5F-8WLX05

MODEL	Swing Nozzle / Goosneck	Aerator / GPM	Supply Nipple	Notes
8" Wall Mount Faucet Models				
5F-8WLX00	—	—	N	Less swing nozzle
5F-8WLX00-EE	—	—	N	Less swing nozzle; 00EE inlets
5F-8WLX03	3" Rigid goosneck	Laminar flow	N	
5F-8WLX05	5-1/2" Swivel goosneck	Laminar flow	N	See photo, left
5F-8WLX06	6" Swing nozzle	Laminar flow	N	
5F-8WLX08	8" Swing nozzle	Laminar flow	N	
5F-8WLX10	10" Swing nozzle	Laminar flow	N	
5F-8WLX12	12" Swing nozzle	Laminar flow	N	See photo, left
5F-8WLX14	14" Swing nozzle	Laminar flow	N	
5F-8WLX16	16" Swing nozzle	Laminar flow	N	
5F-8WLX18	18" Swing nozzle	Laminar flow	N	
8" Wall Mount Faucets with Supply Elbow Kit				
5F-8WLS00	—	—	Y	Less swing nozzle; includes supply elbow kit (B-0230-K)
5F-8WLS06	6" Swing nozzle	Laminar flow	Y	Includes supply elbow kit (B-0230-K)
5F-8WLS10	10" Swing nozzle	Laminar flow	Y	Includes supply elbow kit (B-0230-K)
5F-8WLS12	12" Swing nozzle	Laminar flow	Y	Includes supply elbow kit (B-0230-K)

Certified to NSF/ANSI 61/9



8" Wall Mount Faucets

- 8" wall mount mixing faucet
- Ceramic cartridges with 4" wrist-action handles with color coded screws
- 1/2" NPT female inlets

Note: Converts to rigid with (014200-45) lock washer (sold separately)



5F-8WWX12

B-0230-K

MODEL	Swing Nozzle / Goosneck	Aerator / GPM	Supply Nipple	Notes
8" Wall Mount Faucets with Wrist-Action Handles				
5F-8WWX00	—	—	N	Less swing nozzle
5F-8WWX08	8" Swing nozzle	Laminar flow	N	
5F-8WWX12	12" Swing nozzle	Laminar flow	N	See photo, left
8" Wall Mount Faucets with Supply Elbow Kits				
5F-8WWS06	6" Swing nozzle	Laminar flow	Y	Includes supply elbow kit (B-0230-K)
5F-8WWS12	12" Swing nozzle	Laminar flow	Y	Includes supply elbow kit (B-0230-K)

Certified to NSF/ANSI 61/9

8" Deck Mount Workboard Faucets

- 8" deck mount mixing faucet
- Ceramic cartridges with lever handles with color coded screws
- 1/2" NPT eccentric flanged female inlets
- 1/2" NPT male elbow kit (B-0230-K) sold separately

Note: Converts to rigid with (014200-45) lock washer (sold separately)



5F-8CLX08

MODEL	Swing Nozzle / Goosneck	Aerator / GPM	Supply Nipple	Notes
8" Deck Mount Workboard Faucet Models				
5F-8CLX00	—	—	N	Less swing nozzle
5F-8CLX05	5-1/2" Swing nozzle	Laminar flow	N	
5F-8CLX06	6" Swing nozzle	Laminar flow	N	
5F-8CLX08	8" Swing nozzle	Laminar flow	N	See photo, left
5F-8CLX10	10" Swing nozzle	Laminar flow	N	
5F-8CLX12	12" Swing nozzle	Laminar flow	N	

Certified to NSF/ANSI 61/9

8" Deck Mount Workboard Faucets with Wrist-Action Handles

- 8" deck mount mixing faucet
- Ceramic cartridges with 4" wrist-action handles with color coded screws
- 1/2" NPT eccentric flanged female inlets
- 1/2" NPT male elbow kit (B-0230-K) sold separately

Note: Converts to rigid with (014200-45) lock washer (sold separately)

MODEL	Swing Nozzle / Goosneck	Aerator / GPM	Supply Nipple	Notes
8" Deck Mount Workboard Faucet Models with Wrist-Action Handles				
5F-8CWX00	—	—	N	Less swing nozzle
5F-8CWX05	8" Swing nozzle	Laminar flow	N	
5F-8CWX06	6" Swing nozzle	Laminar flow	N	
5F-8CWX08	8" Swing nozzle	Laminar flow	N	
5F-8CWX10	10" Swing nozzle	Laminar flow	N	
5F-8CWX12	12" Swing nozzle	Laminar flow	N	See photo, below

Certified to NSF/ANSI 61/9



5F-8CWX12



8" Deck Mount Faucets

- 8" deck mount mixing faucet
- Quarter-turn ceramic cartridges with lever handles with color coded screws
- 1/2" NPT female inlets

Note: Convert to rigid from swivel with lock washer (014200-45) sold separately



MODEL	Swing Nozzle / Gooseneck	Aerator / GPM	Supply Nipple	Notes
8" Deck Mount Faucet Models				
5F-8DLX00	—	—	N	Less swing nozzle
5F-8DLX03	3" Rigid gooseneck	Laminar flow	N	
5F-8DLX05	5-1/2" Swivel gooseneck	Laminar flow	N	See photo left
5F-8DLX06	6" Swing nozzle	Laminar flow	N	
5F-8DLX08	8" Swing nozzle	Laminar flow	N	
5F-8DLX10	10" Swing nozzle	Laminar flow	N	
5F-8DLX12	12" Swing nozzle	Laminar flow	N	See photo, left
5F-8DLX14	14" Swing nozzle	Laminar flow	N	
5F-8DLX16	16" Swing nozzle	Laminar flow	N	
5F-8DLX18	18" Swing nozzle	Laminar flow	N	
8" Deck Mount Faucets with Inlet Supply Kits				
5F-8DLS00	—	—	Y	Less swing nozzle; includes supply kit (B-0425-M)
5F-8DLS03	3" Rigid gooseneck	Laminar flow	Y	Includes supply kit (B-0425-M)
5F-8DLS05	5-1/2" Swivel gooseneck	Laminar flow	Y	Includes supply kit (B-0425-M)
5F-8DLS05A	5-1/2" Swivel gooseneck	2.2 GPM Aerator	Y	Includes supply kit (B-0425-M)
5F-8DLS05CA	5-7/8" Swivel gooseneck	2.2 GPM Aerator	Y	Includes supply kit (B-0425-M)
5F-8DLS06	6" Swing nozzle	Laminar flow	Y	Includes supply kit (B-0425-M)
5F-8DLS08	8" Swing nozzle	Laminar flow	Y	Includes supply kit (B-0425-M)
5F-8DLS08A	8" Swing nozzle	2.2 GPM Aerator	Y	Includes supply kit (B-0425-M)
5F-8DLS09	9" Swivel gooseneck	Laminar flow	Y	Includes supply kit (B-0425-M)
5F-8DLS10	10" Swing nozzle	Laminar flow	Y	Includes supply kit (B-0425-M)
5F-8DLS10A	10" Swing nozzle	2.2 GPM Aerator	Y	Includes supply kit (B-0425-M)
5F-8DLS12	12" Swing nozzle	Laminar flow	Y	Includes supply kit (B-0425-M)
5F-8DLS12A	12" Swing nozzle	2.2 GPM Aerator	Y	Includes supply kit (B-0425-M)
5F-8DLS14	14" Swing nozzle	Laminar flow	Y	Includes supply kit (B-0425-M)

Certified to NSF/ANSI 61/9



8" Deck Mount Faucets

- 8" deck mount mixing faucet
- Quarter-turn ceramic cartridges with 4" wrist-action handles with color coded screws
- 1/2" NPT female inlets

Note: Convert to rigid from swivel with lock washer (014200-45) sold separately



5F-8DWX12



B-0425-M

MODEL	Swing Nozzle / Gooseneck	Aerator / GPM	Supply Nipple	Notes
8" Deck Mount Faucets with Wrist-Action Handles				
5F-8DWX00	—	—	N	Less swing nozzle
5F-8DWX08	8" Swing nozzle	Laminar flow	N	
5F-8DWX10	10" Swing nozzle	Laminar flow	N	
5F-8DWX12	12" Swing nozzle	Laminar flow	N	See photo, left
8" Deck Mount Faucets with Wrist-Action Handles and Inlet Supply Kits				
5F-8DWS00	—	—	Y	Less swing nozzle
5F-8DWS03	3" Rigid gooseneck	Laminar flow	Y	Includes supply kit (B-0425-M)
5F-8DWS05	5-1/2" Swivel gooseneck	Laminar flow	Y	Includes supply kit (B-0425-M)
5F-8DWS05A	5-1/2" Swivel gooseneck	2.2 GPM Aerator	Y	Includes supply kit (B-0425-M)
5F-8DWS05CA	5-7/8" Swivel gooseneck	2.2 GPM Aerator	Y	Includes supply kit (B-0425-M)
5F-8DWS06	6" Swing nozzle	Laminar flow	Y	Includes supply kit (B-0425-M)
5F-8DWS08	8" Swing nozzle	Laminar flow	Y	Includes supply kit (B-0425-M)
5F-8DWS08A	8" Swing nozzle	2.2 GPM Aerator	Y	Includes supply kit (B-0425-M)
5F-8DWS09	9" Swivel gooseneck	Laminar flow	Y	Includes supply kit (B-0425-M)
5F-8DWS10	10" Swing nozzle	Laminar flow	Y	Includes supply kit (B-0425-M)
5F-8DWS10A	10" Swing nozzle	2.2 GPM Aerator	Y	Includes supply kit (B-0425-M)
5F-8DWS12	12" Swing nozzle	Laminar flow	Y	Includes supply kit (B-0425-M)
5F-8DWS12A	12" Swing nozzle	2.2 GPM Aerator	Y	Includes supply kit (B-0425-M)
5F-8DWS14	14" Swing nozzle	Laminar flow	Y	Includes supply kit (B-0425-M)

Certified to NSF/ANSI 61/9



5SL-1000

4" Centerset Single Lever Faucet

- 4" centers
- 1/2" NPSM inlets with 3/8" O.D. flexible copper tubing
- 2.0 GPM aerator
- Single lever cartridge replacement – (015232-45)



5SL-1000

5GF-W-F
Wall Mount Glass Filler

- Push back arm design
- 3/8" NPT female inlet
- 2" diameter adjustable slip flange
- Blue self-closing Lexan arm
- Blue Lexan outlet
- Volume control adjustable with screwdriver



5GF-W-F

5GF-W
Wall Mount Glass Filler

- Push back arm design
- 3/8" NPT male inlet
- Blue self-closing Lexan arm
- Blue Lexan outlet
- Volume control adjustable with screwdriver



5GF-W

5GF-8P
Pedestal Deck Mount Glass Filler

- 8" pedestal height (from deck to outlet)
- Push back design
- 1/2" NPT male inlet
- 2" diameter adjustable flange
- Blue self-closing Lexan arm
- Blue Lexan outlet
- Volume control adjustable with screwdriver



5GF-8P

5GF-8P-WS
Glass Filler Water Station

- 8" pedestal glass filler with retro design
- Push back design
- 18 gauge stainless steel drip pan
- 1/4" drain
- 1/2" NPT male inlet
- 2" diameter adjustable flange
- Blue self-closing Lexan arm
- Blue Lexan outlet
- Volume control adjustable with screwdriver
- Stainless steel screws for mounting included
- Suggested drip pan cut-out: 10 1/2" x 5"

5GF-12P
Pedestal Deck-Mount Glass Filler

- Same as 5GF-8P except with 12" pedestal height

5GF-16P
Pedestal Deck-Mount Glass Filler

- Same as 5GF-8P except with 16" pedestal height

5GF-RK
Glass Filler Repair Kit
(not shown)

Replacement parts kit includes:

- (2) Springs
- (1) Handle screw
- (1) Handle nut
- (2) Seat washers
- (2) O-rings
- (2) Bonnet washers
- (2) Stem packings
- (2) Outlet washers
- (1) Outlet tip
- (1) Lever arm
- (1) Silicon grease tube



5GF-8P-WS

Equip 5HR-232, 5HR-242 and 5HR-342 Open Hose Reels

FEATURES:

Reel and Base

- Powder coated steel
- Thick steel structure
- Extra ribs for strength

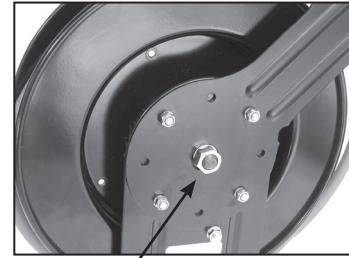

Guide Arm

- 4-position orientation
- Mounted independently
- Easily adjustable
- Thick steel structure
- Extra ribs for strength

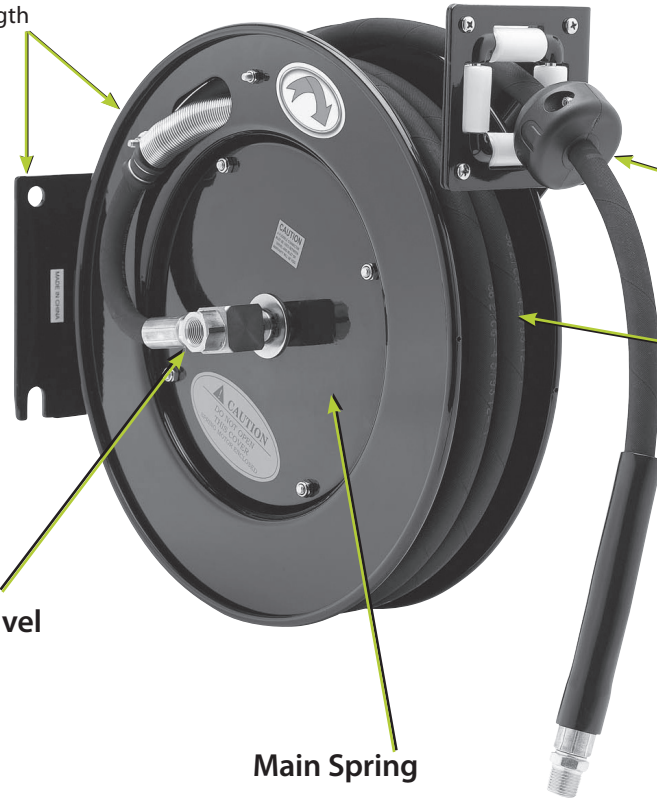

Adjustable Hose Stop

Hose

- Reinforced wear-resistant black cover
- 35' and 50' hose lengths
- 300 PSI max.
- 176°F maximum temperature

Heavy-Duty Brass Swivel

- Outboard of reel
- 3/8" NPT female inlet
- Easy 'O'-Ring service
- 'O'-Ring: Buna-N nitrile and two nylon wearing rings

Main Spring

- Proprietary spring alloy
- Exceeds 25K pull cycle test
- Easy and safe service

I
22

5SV-H High Flow Spray Valve

- For washdown applications; not intended for use with pre-rinse units (does not include handle)
- Add "-01" to models to include spray valve with handle
- 3/4-14 inlet
- EPAct 2005 Non-compliant



- Also available:

5SV-H-RK	Sprayface repair kit
5SV-WH	High flow spray valve with handle

5WG-1000-01 Water Gun

- Water gun with lockable trigger and adjustable spray nozzle
- Includes quick-disconnect with 3/4" garden hose female inlet
- 1/2" NPSM female and 3/8" NPT female adapters



Equip Open Hose Reels

- $\frac{3}{8}$ " and $\frac{1}{2}$ " NPT connections
- Replacement parts
- Optional spray valve models available

5HR-232, 5HR-242 and 5HR-342

Open Hose Reels

- Black epoxy coated steel
- 35' and 50' hose lengths
- $\frac{3}{8}$ " I.D. hose
- Hose is rated at 300 PSI with a maximum temperature of 176°F
- $\frac{3}{8}$ " NPT male outlet on hose
- $\frac{3}{8}$ " NPT female inlet in reel



5HR-232,
5HR-242
and
5HR-342

Hose Reel Model Options

5HR-232 Models

- 5HR-232 Hose Reel with 35' hose length
- 5HR-232-01 Includes 5SV-WH Spray Valve
- 5HR-232-09 Includes 5WG-1000-01 Water Gun
- 5HR-232-12 Includes EMV-0522-24 Front Trigger Water Gun
- 5HR-232-GH Includes 3 ft. long $\frac{3}{8}$ " NPT male x $\frac{3}{4}$ " garden hose female connector hose
- 5HR-232-01-GH Includes 5SV-WH Spray Valve and 3 ft. long $\frac{3}{8}$ " NPT male x $\frac{3}{4}$ " garden hose female connector hose

5HR-242 Models

- 5HR-242 Hose Reel with 50' hose length
- 5HR-242-01 Includes 5SV-WH Spray Valve
- 5HR-242-09 Includes 5WG-1000-01 Water Gun
- 5HR-242-12 Includes EMV-0522-24 Front Trigger Water Gun
- 5HR-242-GH Includes 3 ft. long $\frac{3}{8}$ " NPT male x $\frac{3}{4}$ " garden hose female connector hose
- 5HR-242-01-GH Includes 5SV-WH Spray Valve and 3 ft. long $\frac{3}{8}$ " NPT male x $\frac{3}{4}$ " garden hose female connector hose

5HR-342 Models

- 5HR-342-01-GH $\frac{1}{2}$ " x 50' Hose with 5SV-WH Spray Valve and 3 ft. long $\frac{1}{2}$ " NPT male x $\frac{3}{4}$ " garden hose female connector hose
- 5HR-342-09-GH $\frac{1}{2}$ " x 50' Hose with 5WG-1000-01 Spray Valve and 3 ft. long $\frac{1}{2}$ " NPT male x $\frac{3}{4}$ " garden hose female connector hose
- 5HR-342-GH $\frac{1}{2}$ " x 50' Hose with 3 ft. long $\frac{1}{2}$ " NPT male x $\frac{3}{4}$ " garden hose female connector hose



5HR-232-12

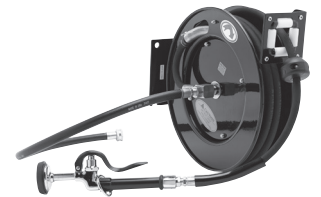

5HR-342-01-GH

Equip 5HR-222 Hose Reel Models with 25' Hose

5HR-222 Open Hose Reels

- Black powder coated steel
- 3/8" x 25' hose (5HR-2HSE-25)
- Stainless steel shaft and brass swivel with 3/8" NPT female inlet (left side of reel)
- Includes mounting bracket with holes and slots

5HR-222 Models

- 5HR-222 Hose Reel with 25' hose length
- 5HR-222-12 Includes EMV-0522-24 Front Trigger Water Gun



Equip 5HR-232 and 5HR-242 Hose Reel Models

5HR-232 Hose Reels

- Black powder coated steel
- 3/8" x 35' hose
- Stainless steel shaft and brass swivel with 3/8" NPT female inlet (left side of reel)
- Includes mounting bracket with holes and slots

5HR-242 Hose Reels

- Black powder coated steel
- 3/8" x 50' hose
- Stainless steel shaft and brass swivel with 3/8" NPT female inlet (left side of reel)
- Includes mounting bracket with holes and slots



5HR-232-01
5HR-242-01

Includes
5SV-WH Spray Valve

5HR-232-09
5HR-242-09

Includes
5WG-1000-01 Water Gun
with Quick-Disconnect
and 3/8" and 1/2" Adapters

Spray Outlet Options

5SV-WH
Hose Reel Spray Valve



5SV-H
High-Flow Spray Valve (4.0+ gpm)



5WG-1000-01
Front Trigger
Water Gun with
Quick-Disconnect
and Adapters



Hose Reel Assembly Replacement Parts

Description	35' Open Reel	50' Open Reel
Spring Assembly	G016682-45	G016684-45
Complete Swivel Asy.	5HR-2SA	5HR-2SA
Seal Kit	014948-45	014948-45
Hose Assembly	5HR-2HSE-35	5HR-2HSE-50

equip Complete Hose Reel Systems



The equip solution to ensure code compliance and efficiency

*We offer a wide selection of
equip Complete Hose Reel System models*

E1 System Type

E2 System Type

- 1 Flexible hose connections
- 2 Vacuum breakers
- 3 Open Hose Reels with various length hoses
- 4 Water guns and Spray valves
- 5 Includes Check valves, Risers, and Wall brackets
- 6 Mixing valves and faucet bases

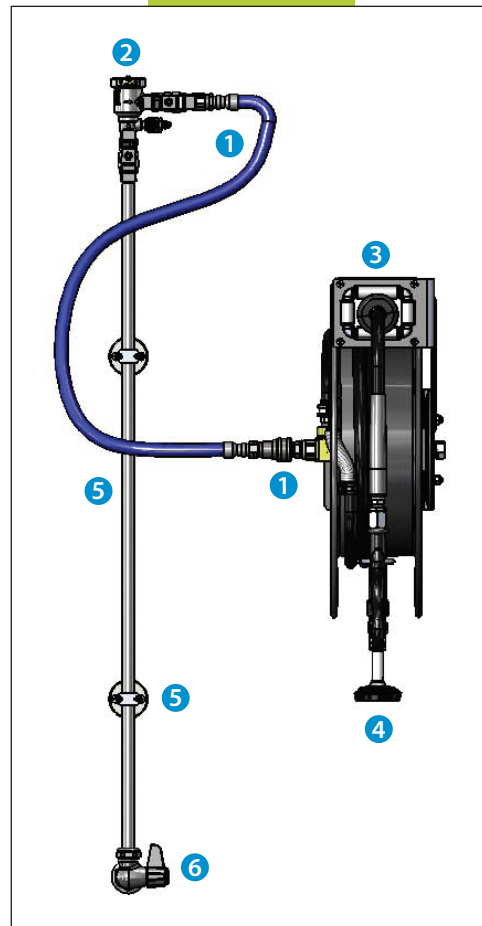
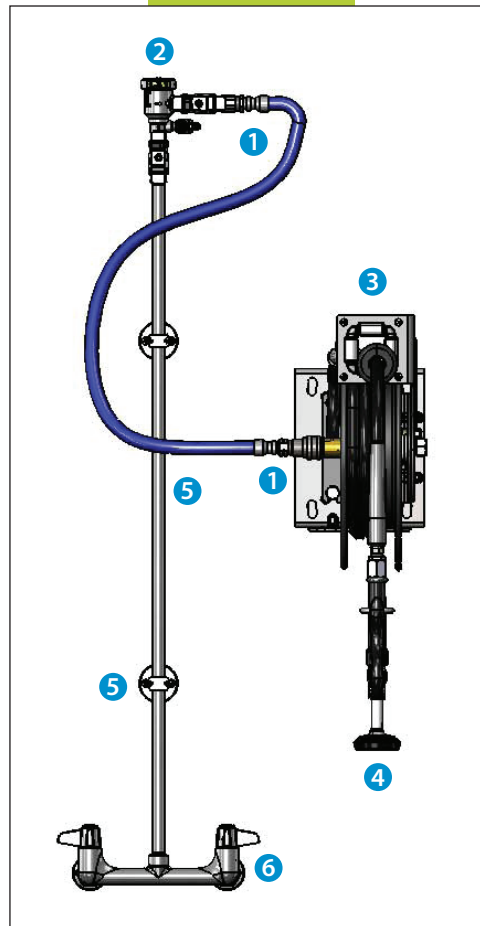

*equip can help you configure a custom system
based on your needs with a wide variety of options*

For more information about our new Equip Hose Reel Systems and a list of available models, see the *Smart Model Key for Equip Complete Hose Reel Systems*.



Smart Model Key for Equip Complete Hose Reel Systems

Example:

5HR - 2 3 2 - 01 X E1

<p>Hose Reel 222 = 25' x 3/8" 232 = 35' x 3/8" 242 = 50' x 3/8" 342 = 50' x 1/2"</p>	<p>Spray Outlet, Connector and Adapter -01 = 5SV-WH -09 = 5WG-1000-01 -12 = EMV-0522-24 -GH = Garden Hose Connector -01GH = 5SV-WH and Garden Hose Connector</p>	<p>Mounting Brackets P = Pivot/Ceiling Bracket W = Wall Swing Bracket T = Table Leg Bracket X = No Bracket</p>	<p>System Type* E1 = 8" Wall Mount with in-line check valves (System 1) E2 = Single Hole Wall Mount (System 2)</p>
---	--	---	---

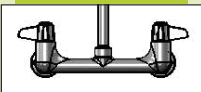
***System Type:**

<p>E1 8" Wall Mount</p> 	<p>E2 Single Hole Wall Mount</p> 
---	--

Model (for example): 5HR-232-01WE1 5HR-242-01XE2

Spray Outlet, Adapters and Connectors



5SV-WH Hose Reel Spray Valve with Handle

5WG-1000-01 Front Trigger Water Gun with Quick-Disconnect and Adapters

EMV-0522-24 Front Trigger Water Gun

Available Models:

Equip Hose Reel Systems Models		
5HR-232-01WE1	5HR-232-01XE2	5HR-242-01XE1
5HR-232-01WE2	5HR-242-01WE1	5HR-242-01XE2
5HR-232-01XE1	5HR-242-01WE2	



equip by T&S Brass 2 Saddleback Cove · Travelers Rest, SC 29690 · phone 800-476-4103 · fax 800-868-0084
www.tsbrass.com

Equip Pre-Rinse Unit Accessories

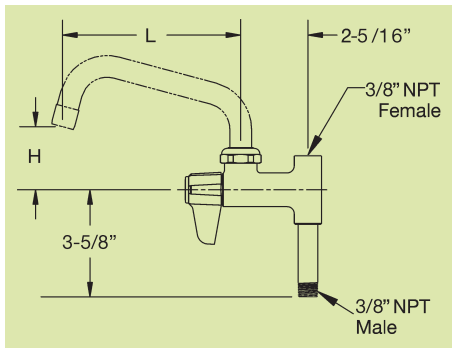

5AFL12



5AFL00

Add-On Faucets with Swing Nozzles in various lengths

- For pre-rinse units
- 3/8" NPT female outlet, 3/8" NPT male inlet
- Model No.:

- 5AFL18 18" Swing nozzle and laminar flow device
- 5AFL16 16" Swing nozzle and laminar flow device
- 5AFL14 14" Swing nozzle and laminar flow device
- 5AFL12 12" Swing nozzle and laminar flow device
- 5AFL10 10" Swing nozzle and laminar flow device
- 5AFL08 8" Swing nozzle and laminar flow device
- 5AFL06 6" Swing nozzle and laminar flow device
- 5AFL00 Faucet less nozzle

Certified to NSF/ANSI 61/9

Model No.	Description	"H" Inches	"L" Inches
5AFL00	No nozzle	N/A	N/A
5AFL06	6" nozzle	2-3/16"	6-1/8"
5AFL08	8" nozzle	2-3/4"	8-1/8"
5AFL10	10" nozzle	3-1/4"	10-1/8"
5AFL12	12" nozzle	3-3/4"	12-1/8"
5AFL14	14" nozzle	4-3/8"	14-1/8"
5AFL16	16" nozzle	4-7/8"	16-1/8"
5AFL18	18" nozzle	5-3/8"	18-1/8"

013716-40 6" Wall Bracket



5PR-VB Vacuum Breaker

- Equip vacuum breaker, 3/8" NPT, female inlet and outlet
- Dual check valve
- Not for continuous pressure applications



5SV Spray Valve for All Equip Pre-Rinse Units

- 3/4-14 inlet
- 2019 DOE Compliant
- 1.15 GPM at 60 PSI
- Does not include handle
- Also available:

- 5SV-B Spray valve bonnet assembly
- SV-RK Spray valve repair kit (includes bumper ring, spray face and screw)



2019 DOE Compliant

014068-45 Overhead Spring

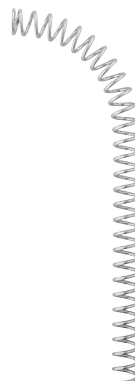

000369-40 Riser

- 3/8" NPT ends
- 18" long
- Pre-rinse riser



5SV-C Spray Valve for All Equip Pre-Rinse Units

- 1.2 GPM at 60 PSI
- Does not include handle



2019 DOE Compliant

5HSE44 Stainless Steel Hose

- 44" length
- Flexible stainless steel outer cover
- Rubber inner hose
- Includes (2) washers and grip handle
- Other hose lengths available:

- 5HSE68 68" hose
- 5HSE84 84" hose
- 5HSE96 96" hose



Equip Hose Reel Accessories

5SV-H High Flow Spray Valve

- Not intended for warewashing
- Does not include handle
- 2019 DOE Non-compliant



5SV-WH Spray Valve, Handle and Ring

- Same as 5SV-H spray valve except includes handle and ring
- 2019 DOE Non-compliant



5WG-1000-01 Water Gun

- With 3/4" garden hose female quick-disconnect, and 1/2" and 3/8" adapters



5HR-2HSE-35 Black Hose Assembly

- 35' black hose
- Max. pressure: 300 PSI
- Maximum temp. -176°F
- Stainless steel spring protector
- 3/8" NPT both ends
- Also available: 5HR-2HSE-50 50' black hose



5HR-HDL Hose Reel Grip Handle Assembly

- Black handle assembly with 1/2" NPSM inlet
- Attaches to 5SV-H high flow spray valve
- Includes washer



5HR-2SA Swivel Assembly

- 3/8" NPT swivel assembly with stainless steel inlet and brass swivel outlet



Equip – Other Accessories

Ceramic Cartridge Assembly

- Quarter-turn
- Hot Cartridge: 013787-45
- Cold Cartridge: 013788-45



5-HDL-W 4" Wrist Action Handle Kit

- Includes one handle and two color coded screws (hot and cold)



5F-VF05 Vandal Resistant Non-Aerated Spray Device

- Water-saving 0.5 GPM flow
- 3/4-27UN female thread
- Can be substituted on any Equip faucet
- Includes vandal resistant key



5-HDL-L Lever Handle Kit

- Includes one handle and two color coded screws (hot and cold)



B-0425-M Deck Mount Inlet Kit

- 1/2" NPT on both ends of 2" long nipples (2)
- Includes lock nuts and lock washers



B-0230-K Wall Mount Inlet Kit

- 1/2" NPT close nipples, lock nuts and washers
- 1/2" NPT male and female short el
- Includes (2)



Equip Goosenecks/Nozzles

Swing Nozzles

- 3/4-27 Laminar outlet
- Available:
 - 5SP-18 18" swing nozzle
 - 5SP-16 16" swing nozzle
 - 5SP-14 14" swing nozzle
 - 5SP-12 12" swing nozzle
 - 5SP-10 10" swing nozzle
 - 5SP-08 8" swing nozzle
 - 5SP-06 6" swing nozzle



Certified to NSF/ANSI 61/9

5SP-03 3" Rigid Gooseneck

- 3/4-27 Laminar outlet
- 5" clearance
- 8-3/4" height



5SP-03

5SP-05 Swivel Gooseneck

- 3/4-27 Laminar outlet
- 5-3/4" clearance
- 11-1/16" height



5SP-05

OPTIONS – Equip Goosenecks/Nozzles with 2.2 GPM Aerators

5SP-03A 3" Swivel Gooseneck

- 3/4-27 2.2 GPM aerator outlet
- 5-5/16" clearance
- 9-1/8" height

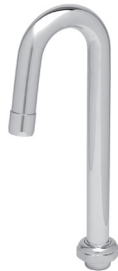

5SP-08A 8" Swing Nozzle

- 3/4-27 2.2 GPM aerator outlet
- 4-5/8" height



5SP-05A 5 1/2" Swivel Gooseneck

- 3/4-27 2.2 GPM aerator outlet
- 5-3/4" clearance
- 11-1/16" height



5SP-10A 10" Swing Nozzle

- 3/4-27 2.2 GPM aerator outlet
- 5-1/8" height



5SP-06A 6" Swing Nozzle

- 3/4-27 2.2 GPM aerator outlet
- 4-1/16" height



5SP-12A 12" Swing Nozzle

- 3/4-27 2.2 GPM aerator outlet
- 5-11/16" height



Certified to NSF/ANSI 61/9



RELIABILITY BUILT IN™

G-12

J *Pet-Care Plumbing Products*



T&S Quality Pet-Care Plumbing Products – Our Pedigree is Your Quality Assurance



T&S Brass Pet-Care Plumbing Specialty Products

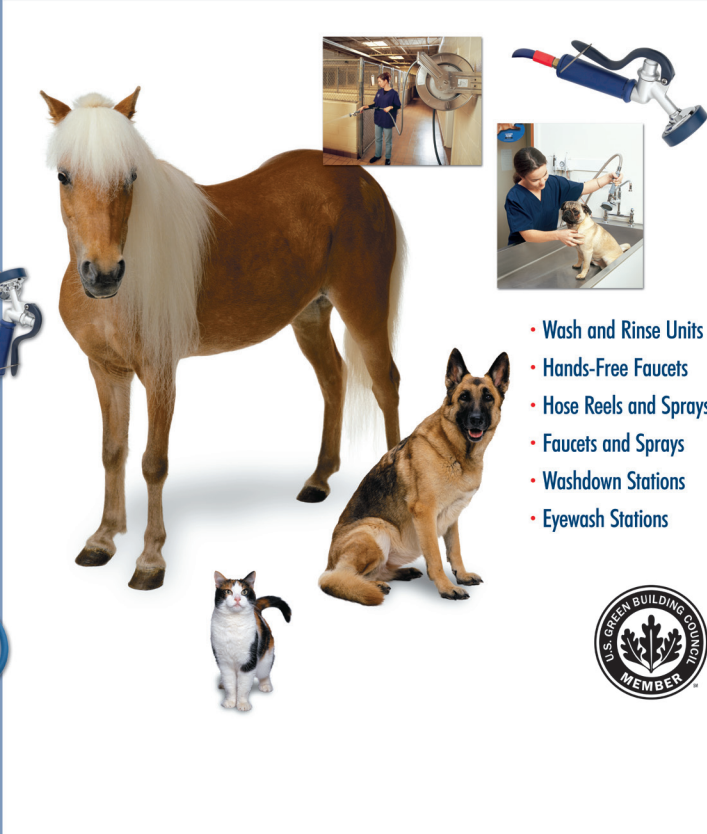

- Wash and Rinse Units
- Hands-Free Faucets
- Hose Reels and Sprays
- Faucets and Sprays
- Washdown Stations
- Eyewash Stations



For more than 70 years T&S Brass has been setting the standard of excellence in the commercial plumbing business.

Today, we manufacture a full line of quality grooming and pet-care plumbing products to make cleaning – and cleaning up after – even your toughest customers easy, safe, thorough and fast.

T&S pet-care products offer a wide range of tools and accessories designed to be versatile and withstand heavy use in kennels, grooming stations, veterinary clinics, boarding facilities and stables. T&S quality pet-care products are certified, always in stock and available worldwide. Plus, only T&S can get your order to you next day thanks to our exclusive T&S Brass 24-Hour Quick Ship program.

T&S delivers:

- Heavy-duty, commercial-grade products
- A wide range of features and options including sanitizing and interior/exterior capabilities
- Durable, corrosion-resistant stainless steel construction
- Easy to use, fully adjustable products
- Custom designed systems to meet your individual needs



RINSE UNITS

Wash and Rinse Products

PG-4DREV
Lightweight Aluminum Spray Unit

- 4" (102 mm) deck mount faucet (B-0236-LN)
- 1/2" NPT female eccentric flanged inlets (00AA)
- Vacuum breaker outlet
- 9 ft. coiled hose and aluminum spray valve
- Lightweight spray valve for easy, all-day use
- Wall hook



PG-1DREV Same as PG-4DREV except single hole single temperature deck mount faucet with vacuum breaker
PG-8DREV Same as PG-4DREV except with 8" (203 mm) centers

PG-8WREV
Lightweight Aluminum Spray Unit



- 8" (203 mm) wall mount faucet
- 1/2" NPT female eccentric flanged inlets (00AA)
- Vacuum breaker outlet
- 9 ft. coiled hose and aluminum spray valve
- Lightweight spray valve for easy, all-day use
- Wall hook



PG-35AV-CH
Coiled Hose and Spray Valve

- Lightweight aluminum handle with rubber grip and hold down clip
- 1/4" NPT male inlet
- Coiled polyurethane hose with maximum stretching length of 9 ft.



Replacement Parts:

Model #	Description
EB-10K	Repair Kit
013539-45	Replacement Hose
PG-35AV	Aluminum Valve

PG-35AV-CH01 Same as PG-35AV-CH except with 3/4" female garden hose inlet (PG-0001)
PG-35AV-CH02 Same as PG-35AV-CH except with 3/8" NPT female inlet (PG-0002)
PG-35AV-CH03 Same as PG-35AV-CH except with 1/2" female inlet (PG-0003)
PG-35AV-CH05 Same as PG-35AV-CH except with 3/4" x 14 female inlet (052A)

PG-8WSAV
Lightweight Aluminum Spray Unit



- 8" (203 mm) wall mount faucet
- 1/2" NPT female eccentric flanged inlets (00AA)
- Vacuum breaker
- 9 ft. coiled hose and aluminum spray valve
- Swivel adapter
- Add-on faucet with 8" swing nozzle and stream regulator outlet
- Lightweight spray valve for easy, all-day use
- Wall hook

PG-1WSAV-06 Same as PG-8DSAV-08 except single hole wall mount faucet with vacuum breaker, 9 ft. coiled hose and 6" swing nozzle



RINSE UNITS

Wash and Rinse Products

P3-8WESV-08M
Sink Faucet with Hose Spray

- 8" (203 mm) wall-mount faucet
- EB-0107-035 high flow angled blue spray valve
- Vacuum breaker
- Add-on faucet with 8" swing nozzle and stream regulator outlet
- Swivel adapter with 96" flexible stainless steel hose (EB-0096-H)
- Hanger hook assembly (B-0166)
- ½" NPT female eccentric flanged inlets (00AA)

Note: this model is 2019 DOE Non-Compliant

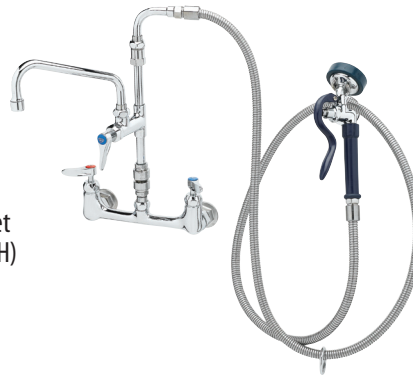

P3-8DESV00NCJZF
Sink Faucet with Hose Spray

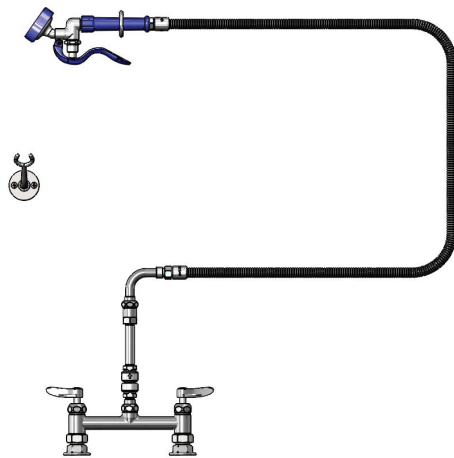

- 8" (203 mm) deck mount mixing faucet
- Cerama cartridges with check valves and color coded lever handles
- Vacuum breaker
- 60" flexible stainless steel hose on 90° swivel adapter and high-flow angle spray valve (blue)
- Hanger hook
- ½" NPT female inlets

B-1171
Sink Faucet with Side Spray



- 4" (102 mm) deck mount faucet
- Side spray with 4 ft. reinforced vinyl hose and hose guide
- 8" (203 mm) swing nozzle
- ½" NPT male inlets
- Built-in diverter

B-1171-07 Same as B-1171 except with 7 ft. hose
 B-1172 Same as B-1171 except with 8" centers
 B-1172-07 Same as B-1172 except with 7 ft. hose

B-2730
Swivel Base Faucet with Side Spray

- 9" spout
- Deck plate
- Single lever handle and ceramic cartridge
- Flexible supply hoses
- 4 ft. vinyl hose with hose guide



B-2730-LH Same as B-2730 except with 6" long handle
 B-2730-07 Same as B-2730 except with 7 ft. hose

B-2743
Single Lever Faucet with Side Spray



- Single hole deck mount faucet
- Swivel gooseneck assembly with aerator
- Two 17" flexible supply hoses with ½" NPSM compression fittings
- Integral diverter for water flow through side spray or gooseneck



RINSE UNITS

Wash and Rinse Products

PG-1WESV-FS
Pet Grooming Unit

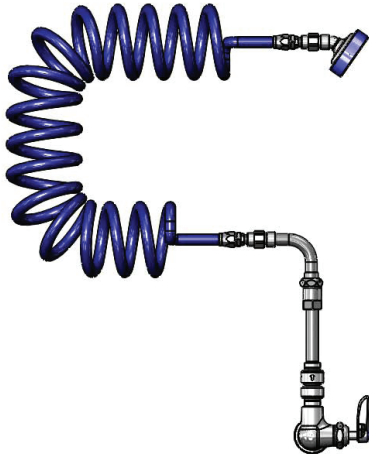

- Single hole single temperature wall mount faucet
- Cerama cartridge with check valve and lever handle with blue color coded index
- Vacuum breaker
- 9 ft. coiled hose and angled high-flow spray head
- ½" NPT female inlet

PG-8WESV00ZCJZF
Sink Faucet with Hose Spray

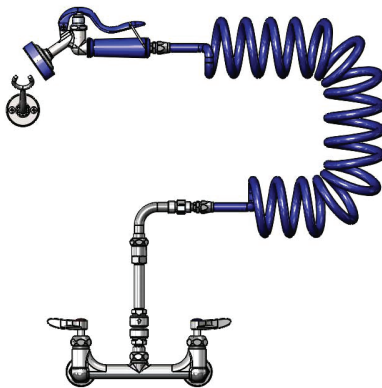

- 8" (203 mm) wall mount mixing faucet
- Cerama cartridges with check valves and lever handles with color coded indexes
- Vacuum breaker
- 9 ft. coiled hose and high-flow angle spray valve (blue)
- Hanger hook
- ½" NPT female inlets

PG-8DESV00ZCJZF
Sink Faucet with Hose Spray

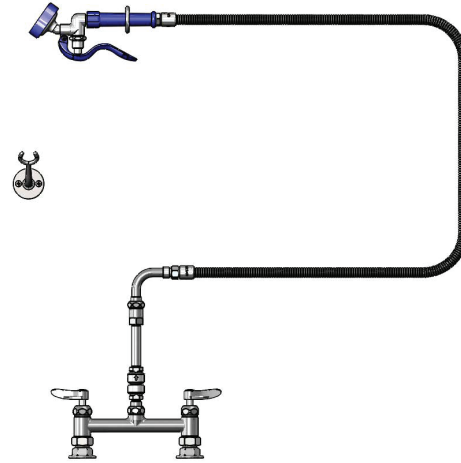

- 8" (203 mm) deck mount mixing faucet
- Cerama cartridges with check valves and lever handles with color coded indexes
- Vacuum breaker
- 9 ft. coiled hose and high-flow angle spray valve (blue)
- Hanger hook
- ½" NPT female inlets

PG-8WESV08ZCJZF
Sink Faucet with Hose Spray

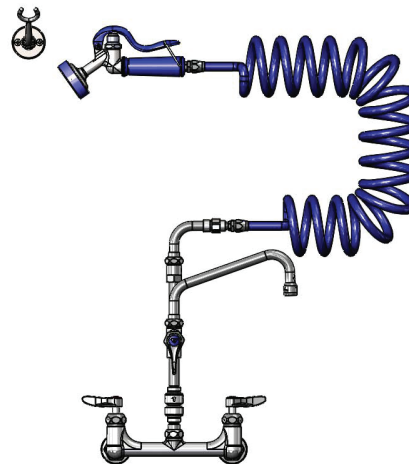

- 8" (203 mm) deck mount mixing faucet
- Cerama cartridges with check valves and lever handles with color coded indexes
- Add-on faucet with 8" (203 mm) swing nozzle with stream regulator
- Vacuum breaker
- 9 ft. coiled hose and high-flow angle spray valve (blue)
- Hanger hook
- ½" NPT female inlets



RINSE UNITS

Wash and Rinse Products

PG-8DSAN-XX
Pet Grooming Station

- 8" (203 mm) deck mount mixing faucet
- ½" NPT female eccentric flanged inlets (00AA)
- 034A swivel adapter
- 9 ft. coiled hose and aluminum spray valve
- Lightweight spray valve for easy all-day use
- Add-on faucet with swing nozzle and stream regulator outlet

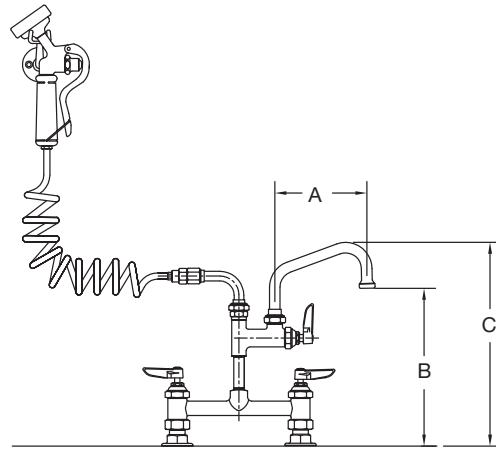

Model No.	"A" Nozzle Spread	"B" Clearance	"C" Height
PG-8DSAN-06	6" (152 mm)	10-1/4" (260 mm)	13-1/4" (336 mm)
PG-8DSAN-08	8" (203 mm)	10-9/16" (268 mm)	13-5/16" (338 mm)
PG-8DSAN-10	10" (254 mm)	11-1/4" (285 mm)	14" (356 mm)
PG-8DSAN-12	12" (305 mm)	11-3/8" (289 mm)	14-1/8" (359 mm)
PG-8DSAN-14	14" (356 mm)	12-5/8" (320 mm)	15-3/8" (391 mm)
PG-8DSAN-16	16" (406 mm)	13-7/16" (341 mm)	16-3/16" (411 mm)
PG-8DSAN-18	18" (457 mm)	14" (356 mm)	16-3/4" (426 mm)

PG-8DSAV-XX
Pet Grooming Station

- 8" (203 mm) deck mount mixing faucet
- ½" NPT female eccentric flanged inlets (00AA)
- 034A swivel adapter
- Vacuum breaker
- 9 ft. coiled hose and aluminum spray valve
- Lightweight spray valve for easy all-day use
- Add-on faucet with swing nozzle and stream regulator outlet

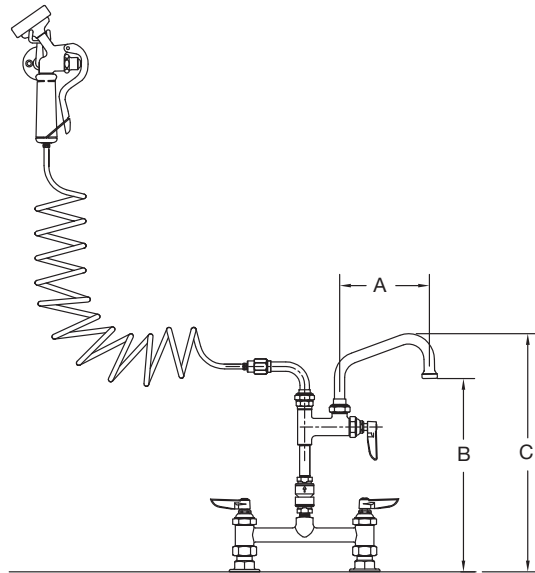

Model No.	"A" Nozzle Spread	"B" Clearance	"C" Height
PG-8DSAV-06	6" (152 mm)	12-7/8" (327 mm)	15-7/8" (403 mm)
PG-8DSAV-08	8" (203 mm)	13-3/16" (335 mm)	15-15/16" (405 mm)
PG-8DSAV-10	10" (254 mm)	13-7/8" (352 mm)	16-5/8" (422 mm)
PG-8DSAV-12	12" (305 mm)	14" (356 mm)	16-3/4" (426 mm)
PG-8DSAV-14	14" (356 mm)	15-1/4" (387 mm)	18" (457 mm)
PG-8DSAV-16	16" (406 mm)	16-1/16" (408 mm)	18-13/16" (478 mm)
PG-8DSAV-18	18" (457 mm)	16-5/8" (422 mm)	19-3/8" (492 mm)

PG-8DSAV-06



RINSE UNITS

Wash and Rinse Products

PG-8WOAN-XX
Pet Grooming Station

- 8" (203 mm) wall mount mixing faucet
- 1/2" NPT female eccentric flanged inlets (00AA)
- 12" (305 mm) overhead arm with swivel
- 9 ft. coiled hose and aluminum spray valve
- Lightweight spray valve for easy all-day use
- 2-3/8" wall bracket (B-0109-07)
- Add-on faucet with swing nozzle and stream regulator outlet

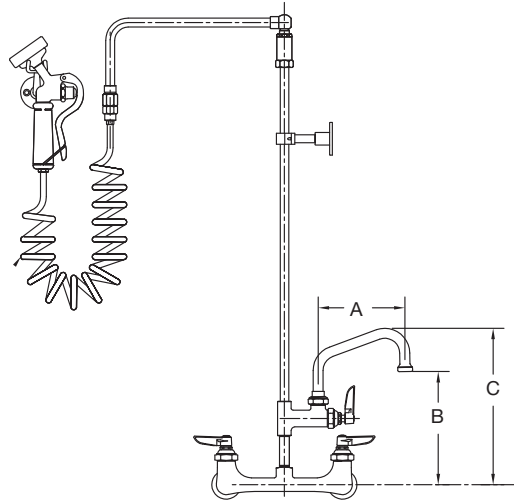

Model No.	"A" Nozzle Spread	"B" Clearance	"C" Height
PG-8WOAN-06	6" (152 mm)	7-13/16" (198 mm)	10-3/4" (274 mm)
PG-8WOAN-08	8" (203 mm)	8-1/16" (206 mm)	10-7/8" (276 mm)
PG-8WOAN-10	10" (254 mm)	8-13/16" (223 mm)	11-9/16" (293 mm)
PG-8WOAN-12	12" (305 mm)	8-15/16" (226 mm)	11-11/16" (297 mm)
PG-8WOAN-14	14" (356 mm)	10-3/16" (258 mm)	12-15/16" (328 mm)
PG-8WOAN-16	16" (406 mm)	11" (279 mm)	13-3/4" (349 mm)
PG-8WOAN-18	18" (457 mm)	11-9/16" (293 mm)	14-5/16" (363 mm)

PG-8WSAV-XX
Pet Grooming Station

- 8" (203 mm) wall mount mixing faucet
- 1/2" NPT female eccentric flanged inlets (00AA)
- 034A swivel adapter
- Vacuum breaker
- 9 ft. coiled hose and aluminum spray valve
- Lightweight spray valve for easy all-day use
- Add-on faucet with swing nozzle and stream regulator outlet

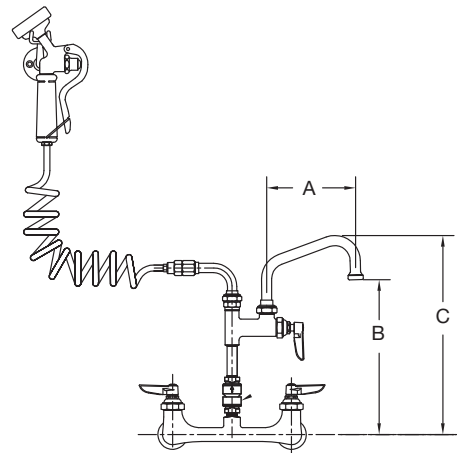

Model No.	"A" Nozzle Spread	"B" Clearance	"C" Height
PG-8WSAV-06	6" (152 mm)	10-7/16" (265 mm)	13-3/8" (340 mm)
PG-8WSAV-08	8" (203 mm)	10-3/4" (272 mm)	13-1/2" (343 mm)
PG-8WSAV-10	10" (254 mm)	11-7/16" (290 mm)	14-3/16" (360 mm)
PG-8WSAV-12	12" (305 mm)	11-9/16" (293 mm)	14-5/16" (363 mm)
PG-8WSAV-14	14" (356 mm)	12-13/16" (325 mm)	15-9/16" (395 mm)
PG-8WSAV-16	16" (406 mm)	13-5/8" (346 mm)	16-3/8" (416 mm)
PG-8WSAV-18	18" (457 mm)	14-3/16" (360 mm)	16-15/16" (430 mm)





RINSE UNITS

Wash and Rinse Products

B-1174
Deck Mount Faucet with Spray

- 8" (203 mm) deck mount mixing faucet
- Side spray with 4 ft. reinforced vinyl hose with hose guide
- 8-3/4" swivel gooseneck with stream regulator outlet
- Lever handles
- 1/2" NPT male inlets
- Includes (150A) tailpieces and nuts for 1/4" NPT connections



B-1176
Deck Mount Faucet with 7 Ft. Spray

- 8" (203 mm) centers deck mount mixing faucet
- EB-0107 high-flow blue spray valve
- EB-0084-H flexible stainless steel hose (under counter) with hose deck flange
- 8-13/16" swivel gooseneck assembly with aerator outlet (B-0199-01)
- Wrist-action handles
- 1/2" NPT male inlets
- Includes (150A) tailpieces and nuts for 1/4" NPT connections



Note: this model is 2019 DOE Non-Compliant

B-1146-01
Wall Mount Faucet

- 4" (102 mm) centers wall mount mixing faucet
- 2-13/16" swivel gooseneck assembly with stream regulator outlet (131X)
- Lever handles
- 1/2" NPT male inlets
- Includes (150A) tailpieces and nuts for 1/4" NPT connections



B-1146-04
Wall Mount Faucet

- 4" (102 mm) centers wall mount mixing faucet
- 5-3/4" swivel gooseneck assembly (133X-AER) with 2.2 GPM aerator (B-0199-01)
- 4" wrist-action handles
- 1/2" NPT male inlets
- Includes (150A) tailpieces and nuts for 1/4" NPT connections



HANDS-FREE FAUCETS

Equip Electronic Faucets



These electronic faucets include:

- AC/DC control module for ease of installation
- Temperature control mixing valve
- Inlet flex lines

5EF-1D-DG
Deck Mount Electronic Faucet

- Single hole deck mount electronic sensor faucet
- 5-11/16" rigid gooseneck with vandal-resistant aerator
- Hands-free operation



5EF-1D-DS
Deck Mount Electronic Faucet

- Single hole deck mount electronic sensor faucet
- 4-9/16" cast spout with vandal-resistant aerator
- Hands-free operation



5EF-1D-WG
Wall Mount Electronic Faucet

- Single hole wall mount electronic sensor faucet
- 6-3/8" rigid/swivel gooseneck with vandal-resistant aerator
- Hands-free operation





HANDS-FREE FAUCETS Other Hands-Free Assemblies

B-0502 Double Pedal Valve



- Floor mount double foot pedal valve
- Inlets on 2-7/16" centers
- 1" (25 mm) from floor to center of inlets
- 1/2" NPT female inlets and outlets

B-0521 Rigid Gooseneck Spout

- Deck mount 5-5/16" rigid gooseneck
- B-0199-02 Aerator
- 10-11/16" high from deck to top of gooseneck
- Includes (150A) tail-piece and nut for 1/4" NPT connection



B-0527 Swivel Gooseneck Spout

- Wall mount 6-1/8" swivel gooseneck (133X-AER)
- B-0199-01 aerator (not shown)
- 2" diameter adjustable flange
- 3/8" NPT female inlet



HOSE REELS Open Epoxy Coated Steel Hose Reels

- Constructed of heavy-duty epoxy-coated steel
- Long life and easy maintenance

These hose reels include:

- EB-0107 high flow blue spray valve
- 3/8" NPT female inlet
- Adjustable hose bumper
- Multi-fit bracket for wall, ceiling or under counter mounting
- Ratcheting system holds the length of hose until a slight tug; retracts automatically

Installation Note:

If mixing valve is used, check valves should be installed to prevent crossflow of water

B-7242-01 Open Hose Reel

- Open epoxy coated steel hose reel
- 50 ft. (15.25 m) hose, 3/8" I.D.

Note: 2019 DOE Non- Compliant

B-7232-01 Open Hose Reel

- Open epoxy coated steel hose reel
- 35 ft. (10.7 m) hose, 3/8" I.D.

Note: 2019 DOE Non- Compliant

B-7212-01 Open Hose Reel

- Open epoxy coated steel hose reel
- 15 ft. (4.5 m) hose, 3/8" I.D.

Note: 2019 DOE Non- Compliant

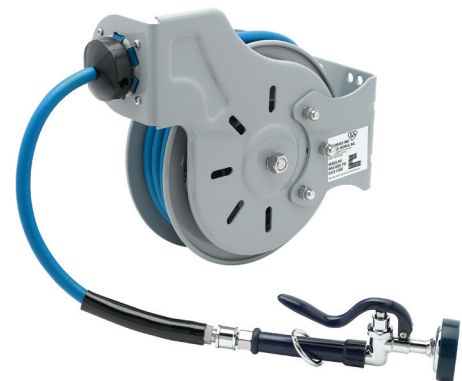



HOSE REELS Open Stainless Steel Hose Reels

- Constructed of heavy-duty corrosion-resistant stainless steel
- Long life and easy maintenance

These hose reels include:

- EB-0107 high flow blue spray valve
- 3/8" NPT female inlet
- Adjustable hose bumper
- Multi-fit bracket for wall, ceiling or under counter mounting
- Ratcheting system holds the length of hose until a slight tug; retracts automatically

Installation Note:

If mixing valve is used, check valves should be installed to prevent crossflow of water

B-7142-01 Open Hose Reel

- Open stainless steel hose reel
 - 50 ft. (15.25 m) hose, 3/8" I.D.
- Note: 2019 DOE Non- Compliant**



B-7132-01 Open Hose Reel

- Open stainless steel hose reel
 - 35 ft. (10.7 m) hose, 3/8" I.D.
- Note: 2019 DOE Non- Compliant**



B-7112-01 Open Hose Reel

- Open stainless steel hose reel
 - 15 ft. (4.5 m) hose, 3/8" I.D.
- Note: 2019 DOE Non- Compliant**

B-7142-01



HOSE REELS Equip Hose Reels

- Constructed of heavy-duty, corrosion-resistant black epoxy-coated steel
- Long life and easy maintenance

These hose reels include:

- 5SV-WH high flow black spray valve
- 3/8" I.D. hose
- 3/8-18 NPT female inlet on reel
- 3/8-18 NPT male outlet on hose
- Hose is rated to 300 PSI with a maximum temperature of 176°F

Installation Note:

If mixing valve is used, check valves should be installed to prevent crossflow of water

5HR-232-01-GH Equip Open Hose Reel

- Open epoxy coated steel hose reel
- 35 ft. (10.7 m) hose, 3/8" I.D.
- Includes 1/2" male x 3/8" female bushing
- 5SV-WH black high-flow spray valve
- 3 ft. connector hose with garden hose adapter for optional connection to garden hose threaded hose bibbs

5HR-232-GH Same as 5HR-232-01-GH except without 5SV-WH high-flow spray valve



5HR-242-01-GH Equip Open Hose Reel

- Open stainless steel hose reel
- 50 ft. (15.25 m) hose, 3/8" I.D.
- 5SV-WH black high-flow spray valve
- 3 ft. connector hose with garden hose adapter for optional connection to garden hose threaded hose bibbs



HOSE REEL ACCESSORIES

Spray Valves and Water Guns

MV-2522-24 Front Trigger Water Gun

- Heavy-duty stainless steel construction, designed for long life
- Adjustable stream from solid to soft spray
- Excellent for cleaning jobs
- Controls water supply easily and efficiently
- 1/2" NPT female inlet
- Automatic shut-off conserves water
- Rated up to 125 psi
- Blue rubber cover



5WG-1000-01 Equip Water Gun

- Front trigger water gun with quick-disconnect and adapters
- With 3/4" garden hose female quick-disconnect and 1/2" and 3/8" adapters
- 2019 DOE Non-Compliant



5SV-WH Equip High Flow Spray Valve

- Blue spray valve for use on all 5HR-series hose reels
- Spray valve, handle and ring
- 3/4-14 male inlet
- 2019 DOE Non-Compliant



EB-0107 High Flow Spray Valve

- Blue spray valve
- Connects directly to hose grip handle
- Hold-down ring for constant water flow
- Shuts off when handle is released



EB-0107-035 35° Angled High Flow Spray Valve

- Blue spray valve with 35° spray head
- Connects directly to hose grip handle
- Hold-down ring for constant water flow
- Shuts off when handle is released



MV-3516-25 Aluminum Rear Trigger Water Gun

- Lightweight aluminum water gun with 5/16" flow orifice
- Blue rubber cover
- Includes 1/2" NPT male x 3/8" NPT female adapter (not shown)
- 1/2" NPT female inlet
- Variable spray patterns
- Drip-free automatic shut-off



EB-2322 Spray Valve, Extension Unit

- Spray valve (EB-0107) with self-closing squeeze valve and extension for 21-3/4" (552 mm) total length
- 3/8" NPT female inlet
- Blue grip handle with hold-down ring
- Removable spray head

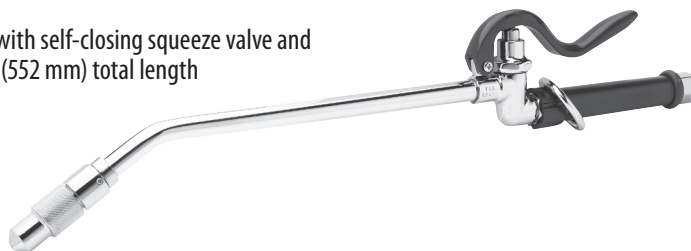

Caution: these Water Guns are not designed for use on steam lines



HOSE REELS Hose Reel Brackets

G018477-45
Table Leg Swing Bracket

- Stainless steel hose reel swing bracket
- Fits all T&S 3/8" and 1/2" hose reels
- Spring loaded latch
- Can be mounted as left- or right-side

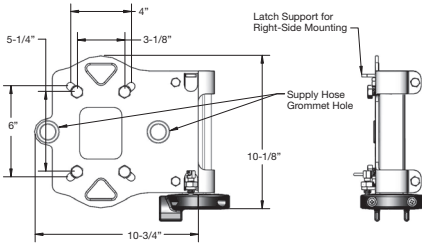

G019430-45
EasyInstall Universal
Stainless Steel Bracket

- 100° rotation stainless steel swing bracket
- Fits all T&S 1/4", 3/8" and 1/2" hose reels



EasyInstall

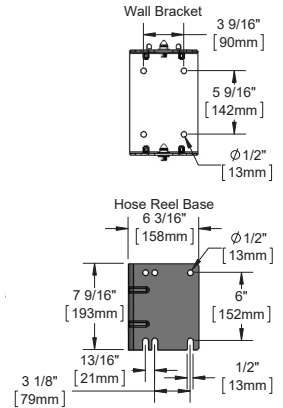

OTHER MODELS And Accessories

B-0665-BSTR
Service Sink Faucet

- 8" (203 mm) wall mount service sink faucet
- Rough chrome plated finish
- Eterna cartridges with spring checks
- Lever handles with color coded indexes
- Built in screwdriver stops
- Atmospheric vacuum breaker spout with 3/4" garden hose male thread and pail hook
- Upper wall support with mounting screws
- 1/2" NPT female eccentric flanged inlets (00AA)



MV-0771-12C
Mixing Valve

- Rough chrome plated
- 3/4" check valves
- 3/4" unions
- 3/4" globe valves with color coded handles



MV-0771-12N Same as MV-0771-12C except unplated brass

B-0963
Continuous Pressure
Vacuum Breaker Assembly

- Designed for continuous pressure
- Furnished with quarter-turn ball valves
- 1/2" NPT female inlet and outlet
- 001359-40 adapters available for 3/8" NPT female connections
- ASSE 1056
- Order a B-0963-RK repair kit:



B-0963-RK

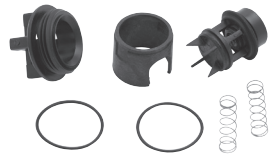

MV-0771-12CW
Washdown Station Assembly

- MV-0771-12C mixing valve (3/4")
- Stainless steel rear trigger water gun (MV-2516-44)
- Chrome plated brass thermometer tee with hose swivel elbow
- Stainless steel thermometer, temperature range 0°-200° F
- 50 ft. (15.25 m) white creamery hose
- Stainless steel hose rack (002970-45)
- Rough plated chrome

MV-0771-12NW Same as MV-0771-12CW except unplated brass

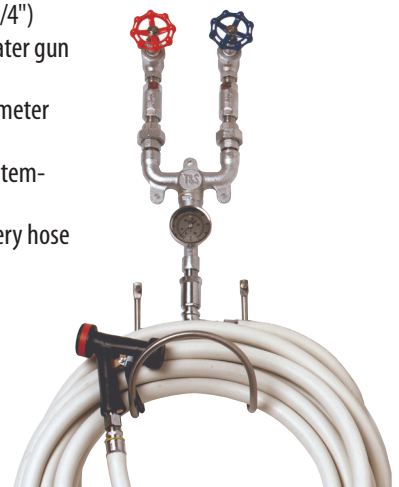



EYEWASH STATIONS

Safety Equipment Models and Accessories

All Eyewash Stations include:

- Universal emergency eyewash sign
- "Test This Week" tag to record weekly testing record of equipment

EW-7360B Wall Mount Eye/Face Wash

- ABS green plastic eyewash head with laminar flow
- Integral flip top dust cover
- Round stainless steel receptor with chrome plated brass stay open ball valve, 1/2" NPT inlet, 1 1/4" NPT waste



EW-7360B-TMV Wall Mount Eye/Face Wash

- ABS green plastic eyewash head with laminar flow
- Integral flip top dust cover
- Round stainless steel receptor with chrome plated brass stay open ball valve, 1/2" NPT inlet, 1 1/4" NPT waste
- Thermostatic mixing valve



EW-7611 Pull-Down Eye/Face Wash Unit

- Countertop mount unit
- Polished chrome plated brass eye/face wash swings forward to activate
- ABS green plastic head with laminar flow
- Integral flip top dust cover
- Can be mounted on either right or left side of sink
- Supply: 1/2" O.D. slip joint



EW-7501 Nine-Gallon Portable Gravity Fed Eyewash Unit

Nine-gallon capacity, high-density green polyethylene tank provides full pattern flushing at .4 GPM for a full 15 minutes

- Fold down eyewash arm has positive upper limit stop that covers and protects spray outlets when not in use
- Wide-fill opening for easy inspection, cleaning and filling
- ABS plastic eyewash heads with tripod anchor, stainless steel socket head cap screw and rubber gasket
- Includes wall bracket
- Eyewash preservative to permit storage of water for up to three months (sold separately; see EW-9082 bottle, right).



Note: Unit must be wall hung

EW-7612 Swing-Away Eyewash Unit

- Countertop mount polished chrome plated brass eye/face wash unit with swing-away feature to activate
- Mounted on right side of sink
- Polyethylene dust cover
- Supply: 1/2" O.D. slip joint



EW-7612LH Same as EW-7612 except mounted on left side of sink

EW-8904 Laboratory Eye/Face Wash Unit

- Countertop mount eye/face and body spray
- Head positioned at 45° angle
- Stay open squeeze lever valve
- 8 ft. swivel hose with 1/2" NPT inlet and deck flange that incorporates guiding key slot for proper positioning of spray

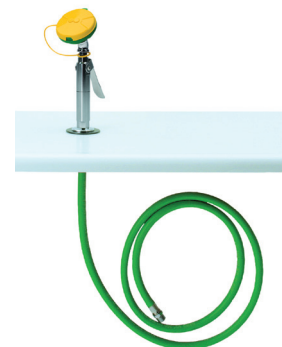

Our toll-free number, 1-800-476-4103, connects you to T&S Customer Service representatives. You can also access information about these and other T&S products on our website, www.tsbrass.com

ACS Accessories



A Pre-Rinse Units



B Pot, Kettle and Glass Fillers



C Faucets and Components



CP ChekPoint™ Electronic Faucets

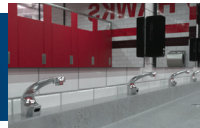

D Institutional, Medical and Lab Products



E Washdown and Clean-Up Solutions



F Safe-T-Link Gas and Water Appliance Connectors



G Parts Kits



H Emergency Safety Equipment by Haws



I Equip Plumbing Products



J Pet Care Plumbing Products



T&S BRASS
G-12 MASTER INDEX

Model No.	Section & Page	Model No.	Section & Page	Model No.	Section & Page	Model No.	Section & Page
004R	A4, 12, 28, 34; B18	001094-45	G10	002726-45	ACS16, 17; G5, 6	009194-25	G7
000176-40	B16	001098-45	ACS16; G5, 6	002840-40CV	A42; B18	009195-25	G7
000357-40	ACS25	001100-45	G3-5, 9-10	002848-40	ACS9; B16	009267-45	G7
000358-40	ACS25; A52; G3	001120-45	A4, 54	002850-40	B17	009268-25	G7
000361-40	ACS25	001121-45	A4, 54; G3	002851-40	B9, 12, 15, 16	009286-40	ACS17
000363-40	ACS25	001136-45	ACS17; G8	002852-40	B17	009287-40	ACS17
000369-40	ACS25; A32; I28	001145-45	G10	002856-40	A4, 54; B16; G3	009306-20	G3, 4, 9
000372-40	A33; ACS25	001191-45NS	G8	002857-40	A43, 45	009331-41	ACS21
000376-40	ACS25	001193-19NS	ACS16,20; G8	002858-40	A43, 45	009332-41	ACS21
000552-25	ACS24	001194-45	ACS20; G8	002861-40	D51, 552	009391-45	G7
000554-25	ACS24	001194-45NS	G8	002864-40	B9	009423-40	ACS17
000555-25	A31	001355-40	ACS24	002865-40	D51, 52	009423-40QT	ACS17
000590-25	B14	001357-40	ACS24	002866-40	B9	009424-40	ACS17
000607-40	ACS16; G7	001359-40	ACS24; J13	002868-40	B12	009424-40QT	ACS17
000607-40NS	ACS16; G7	001466-20	ACS16; G5-8	002872-40	B14	009649-45	G7
000610-25	D39	001479-45	ACS16; G5-8	002878-40	C38	009744-45	ACS16
000685-40NS	ACS16	001621-20	G7	002881-40	A50, 54	009744-45NS	ACS16
000718-25	ACS16; G5, 6	001624-25	ACS24	002882-40	A35, 36	009749-25	ACS17
000718-25NS	ACS16; G5, 6	001625-45	G7	002900-40	B16	009750-25NS	ACS16
000763-20	G6	001636-45	ACS17, 20	002970-45	E26	009752-45	ACS16, 17; G5
000764-20	G3, 5	001636-45AM	ACS20	002987-40	A9; B9	009753-25	ACS17
000788-20	ACS16; G5-7	001636-45NS	ACS20	003090-45	G10	009753-25QT	ACS17
000789-20	ACS16; G5-7	001637-45	ACS17, 20	003105-40	ACS24	009754-25	ACS17
000794-25	ACS16	001637-45AM	ACS20	003164-45	ACS16; G5-8	009754-25QT	ACS17
000800-25	ACS17; G6	001637-45NS	ACS20	003198-45	A55; G10	009937-40	A47; B9
000801-25	ACS17; G6	001638-45	ACS16, 17, 20; G8	003199-45	A55; G10	00AA	ACS22
000811-25	ACS16; G5, 6	001638-45AM	ACS20	003690-45	G9	00BB	ACS22
000812-25	ACS16; G5, 6	001638-45NS	ACS16, 20; G8	004710-25	ACS25	00CC	ACS22
000821-40	G3	001660-45	ACS16, 17; G8	004741-25	ACS25	00EE	ACS22
000888-45	G3	001661-45	ACS16, 17; G8	005311-40	A40	00GG	ACS22
000894-45	G3, 10	001684-25	ACS25	005959-40	ACS14, 16	00GG-RGH	ACS22
000895-45	G3, 4	001686-45	ACS20; G8	005959-40QT	ACS14, 16	00JJ	ACS22
000907-45	A54	001720-40	ACS24	005960-40	ACS14, 16	00JJ-RGH	D41, 42
000913-45	A4, 54; G3, 4	001769-40	ACS25	005960-40QT	ACS14, 16	00JJ-XT	D40, 43
000922-45	ACS16, 17, 20; G5-8	001907-25	ACS16; G6, 7	005963-40	A43	00JJ-XT-RGH	D40
000925-45	ACS16, 20; G5-8	001908-25	ACS16; G6, 7	005969-40	A47	00KK	ACS22
000933-45	ACS16, 17; G5-8	002521-45	G8	006009-40	ACS14, 16	00LL	ACS24
000974-45	G3-5, 9-10	002521-45KNS	ACS21	006009-40QT	ACS14, 16	00QQ	ACS22
000976-45	ACS16; G5	002521-45KNS-VR	ACS21	006010-40	ACS14, 16	00WW	ACS22
000986-45	ACS17; G6	002521-45NS	ACS21; G8	006010-40QT	ACS14, 16	00XX	ACS22
001014-45	A9; G3, 5	002534-25	ACS25	006101-45	B4-6; D38	00XX-RGH	ACS22
001019-45	G3	002535-25	ACS25	006477-40	ACS15	00YY	ACS22
001022-45	ACS16; G5, 6	002584-25	ACS24	006477-40NS	ACS15	010027-40	ACS20
001040-45	G3, 4, 5, 9	002601-45	ACS16; G5, 6	006478-40	ACS15	010094-40	ACS9
001042-45	ACS16; G5	002659-45	A55; G4	006478-40NS	ACS15	010123-45	B5, 8
001047-45	ACS17; G6	002662-40	A55	006481-40NS	ACS16	010126-45	B5, 8
001062-45	G3; G10	002709-40	ACS17	006482-40NS	ACS16; A42	010150-45	G7
001065-45	G3	002710-40	ACS17	006562-45	G7	010196-25	G6
001068-45	G3	002711-40NS	ACS14, 16	006678-45	B10	010381-45	C43
001074-45	G3, 5-7	002712-40NS	ACS14, 16	006895-20	ACS24	010382-45	C43
001075-45	ACS16, 17; G5	002713-40	ACS16	007861-45	A4, 54; G3	010384-45	C43
001088-45	ACS16; G5	002714-40	ACS16	008963-40	A32	010385-45	C43
001092-45	ACS16, 17; G5, 6	002721-45	ACS16; G5	008978-40	D20	010386-45	C43

Model No.	Section & Page	Model No.	Section & Page	Model No.	Section & Page	Model No.	Section & Page
010386-45VR	C43	013E-84H	ACS28	016753-40NS	ACS15	061X-V22	ACS3
010387-45	C43	013429-45	D5	016767-25	ACS19	061XM	ACS3
010388-45	C43	013430-45	G5, 6	016767-25NS	ACS19	062X	A4, 12, 28; ACS3; C4
010389-45	C43	013433-40	ACS21; CP8, 19, 21	016768-25	ACS19	062X-A12	ACS3
010390-45	C43	013434-40	ACS21; CP8, 19, 21	016768-25NS	ACS19	062X-A15	ACS3
010391-45	C43	013539-45	J4	016782-40	B7	062X-A22	ACS3
010392-45	C43	013716-40	I28	016783-40	B8	062XM	ACS3
010393-45	C43	013787-45	I29	016807-45	G3	062XP	ACS6
010393-45XL	C43	013788-45	I29	016887-45	D20	063X	ACS3
010393-45XS	C43	014068-45	I28	016925-40	ACS15	063X-A12	ACS3
010394-45	C43	014086-45	E21	016926-40	ACS15	063X-V15	ACS3
010394-45XS	C43	014087-45	E21	017181-41	ACS21	063X-V22	ACS3
010476-45	A4, 54; G3-5	014145-45	ACS16	017182-45	G7	063XM	ACS3
010563-45	G4	014152-40	ACS16; G6	017208-40	G7	064X	ACS3
010565-45	G4	014187-45	E21	017352-45	E24	064X-A22	ACS3
011278-25	ACS18	014193-40	ACS16, 21; G6	017355-45	E24	064XM	ACS3
011279-25	ACS18	014194-40	ACS16, 21	017359-45	E24	065X	A4; ACS3; C4, 10, 26
011355-45	C43	014195-40	ACS16, 21	017362-45	E24	065X-A22	ACS3
011355-45XL	C43	014200-45	D37; G3; I11,12	017420-45	ACS26, G9	065XM	ACS3
011356-45	C43	014207-40	A46	017670-45	C48	066X	ACS4; C4
011429-45	G3, 7	014462-40	B21	017938-45	E24	066X-A22	ACS4
011456-45	G4	014615-45	G4	017960-25	A54	067X	ACS4; C4
011475-45	G4	014932-45	E24	018163-20	ACS17	067X-A22	ACS4
011616-25	ACS19	014933-45	E24	018200-40	A4, 6, 9, 56	067-HR	B15
011616-25NS	ACS19	014934-45	E24	018292-45	G4	068X	ACS4; C4, 9, 26
011617-25	ACS19	014935-45	E24	018506-19NS	ACS18, 20; G8	068X-A22	ACS4
011617-25NS	ACS19	014936-45	E24	019473-45	E23, 24	069X	ACS4
011618-25	ACS19	014937-45	E24	019499-45	E24	069X-A22	ACS4
011619-25	ACS19	014938-45	E24	019561-45	E23, 24	098A	ACS28; A48; B8
011643-45	G7	014940-45	E24	019779-40	G5, 6	0CS6	ACS7; C4, 9, 15, 18, 19
011676-45	G7	014941-45	E24	019780-40	G5, 6	0CS6-V05	ACS7
012394-25NS	ACS18	014942-45	E24	034A	A40, 46; J7	0CS6-V22	ACS7
012395-25NS	ACS18	014943-45	E24	035A	B16	0CS8	ACS7
012442-40NS	ACS14, 16	014944-45	E24	045A	E24	0CS8-LT	ACS7
012443-40NS	ACS14, 16	014945-45	E24	052A	ACS24, 28; A48; B8; J2	ORK1	E25
012444-25	ACS18	014946-45	E23, 24	053A	ACS24, 28; A48; B8	ORK2	E25
012445-25	ACS18	014947-45	E23, 24	054A	ACS24, 28; A48; B8	ORK3	E25
012446-25NS	ACS18	014948-45	E23, 24; I24	055A	A43, 48; B8	ORK-SK	E24
012447-25NS	ACS18	014949-45	E24	056A	A48; B8	108CSF-RK	G4
012449-40	ACS16	015089-45	E24	057A	ACS24, 28; A48; B8	108HSF-RK	G4
012504-40	A50	015232-45	I21	058A	ACS24, 28; A48; B8	108S-RK	G4
012555-40	G6	015297-40	B21	059A	ACS28; A48; B8	108SF-RK	G4
012596-45	G6, 7	015425-45	ACS10, 21; D70-71	059X	ACS3; C4, 26	108T-RK	G4
012665-45	G3, 9-10	015550-45	B7, 8; G10	059X-A12	ACS3	108V-RK	G4
012915-45	G3-5, 9	015588-40	B7, 8; G10	059X-A22	ACS3	110X	ACS8; B21; B21
012952-45	B16, 17	015589-40	B7, 8; G10	059X-V12	ACS3	112X	ACS8; B21
013146-45	B4, 5; D38	016154-25	E23	059X-V22	ACS3	114X	ACS8; B21
013E-36H	ACS28	016157-25	E23	059XM	ACS3	115X	ACS8; B21
013E-36R	ACS28	016297-45	I3	060X	ACS3; C4, 26	116X	ACS8; B21
013E-48H	ACS28	016325-45	I3	060X-A22	ACS3	117X	ACS8
013E-60H	A43; ACS28	016752-40	ACS15	060XM	ACS3	118X	ACS8
013E-60V	ACS28	016752-40NS	ACS15	061X	ACS3; C4, 26	119X	ACS5; CP22
013E-72H	A43; ACS28	016753-40	ACS15	061X-A22	ACS3	119XP	ACS6

Model No.	Section & Page	Model No.	Section & Page	Model No.	Section & Page	Model No.	Section & Page
120X	ACS5; CP22	153X	ACS4	5EF-1D-DS-VF05	I4	5F-4CW06	I12
120X-LAM	ACS5; CP22	160X	ACS7	5EF-1D-WG	I3; J9	5F-4CW08	I12
120X-LAM-VR	ACS5; CP22	161X	ACS7	5EF-1D-WG-TMV	I3	5F-4CW10	I12
120XM	ACS4; CP22	162X	ACS7	5EF-1D-WG-VF05	I3	5F-4CW12	I12
120XP	ACS6	165X	ACS5; CP22	5EF-2D-DS	I4	5F-4DLS00	I13
122X	ACS5; CP22	166X	D13	5EF-2D-DS-TMV	I4	5F-4DLS03	I13
123X	ACS5; CP22	172A	A48; ACS24, 28; B8	5EF-2D-DS-VF05	I4	5F-4DLS05	I13
124A	D69	175F	A46	5EF-2D-DS-V5-HG	I4	5F-4DLS05A	I13
125X	ACS5; CP22	175FC	B8	5EF-2D-DS-V5THG	I4	5F-4DLS05CA	I13
126X	ACS5; CP22	175FCNS	ACS21	5EF-2D-DS-WS	I4	5F-4DLS06	I13
127X	ACS5	175FHNS	ACS21	5EF-FILTER	I3, 4	5F-4DLS08	I13
127X-V12	ACS5	179X	ACS5	5EF-TMV	I3, 4	5F-4DLS08A	I13
129X	ACS5	179X-A22	ACS5	5F-1SLX00	I11	5F-4DLS09	I13
130X	ACS5	179X-L15	ACS5	5F-1SLX03	I11	5F-4DLS10	I13
131X	ACS4; CP23	179X-V12	ACS5	5F-1SLX05	I11	5F-4DLS10A	I13
131X-A22	ACS4; CP23	179X-V22	ACS5	5F-1SLX05A	I11	5F-4DLS12	I13
131XM	ACS4; CP23	179XP	ACS6	5F-1SLX05CA	I11	5F-4DLS12A	I13
132X	ACS4; CP23	179XP-F05	ACS6	5F-1SLX06	I11	5F-4DLS14	I13
132X-A22	ACS4; CP23	183F	B8	5F-1SLX08	I11	5F-4DLX00	I13
132X-V05	ACS4; CP23	187X	ACS5	5F-1SLX08A	I11	5F-4DLX03	I13
132XM	ACS4; CP23	187A15	ACS5	5F-1SLX10	I11	5F-4DLX05	I13
132XP	ACS5	18L	ACS16	5F-1SLX10A	I11	5F-4DLX06	I13
133X	ACS4; C4; CP23	238A	ACS16; G6	5F-1SLX12	I11	5F-4DLX08	I13
133X-A12	ACS4; CP23	238AB	ACS16	5F-1SLX12A	I11	5F-4DLX10	I13
133X-A15	ACS4; CP23	238AC	ACS16	5F-1SLX14	I11	5F-4DLX12	I13
133X-A22	ACS4; CP23	238AH	ACS16	5F-1SLX18	I11	5F-4DLX14	I13
133X-LAM	ACS4; CP23	5AFL00	I28	5F-1WLX00	I11	5F-4DWS00	I14
133X-LAM-VR	ACS4; CP23	5AFL06	I28	5F-1WLX05	I11	5F-4DWS03	I14
133X-V12	ACS4; CP23	5AFL08	I28	5F-2SLX00	I15	5F-4DWS05	I14
133X-V22	ACS4; CP23	5AFL10	I28	5F-2SLX03	I15	5F-4DWS06	I14
133XM	ACS4; CP23	5AFL12	I28	5F-2SLX05	I15	5F-4DWS08	I14
133XP	ACS6	5AFL14	I28	5F-2SLX05A	I15	5F-4DWS09	I14
133XP-F05	ACS6	5AFL16	I28	5F-2SLX05CA	I15	5F-4DWS10	I14
133XP-F10	ACS6	5AFL18	I28	5F-2SLX06	I15	5F-4DWS12	I14
133XP-F12	ACS6	5EF-0001	I3, 4	5F-2SLX08	I15	5F-4DWS14	I14
133XP-F15	ACS6	5EF-0002	I3, 4	5F-2SLX08A	I15	5F-4DWS14	I14
133XP-F22	ACS6	5EF-0003	I3, 4	5F-2SLX10	I15	5F-4DWS14	I14
134X	ACS4; CP23	5EF-0004	I3, 4	5F-2SLX10A	I15	5F-4DWS14	I14
134XP	ACS6	5EF-0005	B4, 5; D38; I3, 4	5F-2SLX12	I15	5F-4DWS14	I14
135X	ACS4	5EF-0006	I3, 4	5F-2SLX12A	I15	5F-4DWS14	I14
135X-A22	ACS4	5EF-1D-DG	I3; J9	5F-2SLX14	I15	5F-4DWS14	I14
135X-LAM	ACS4	5EF-1D-DG-4DP	I3	5F-2SLX14	I15	5F-4DWS14	I14
135X-LAM-VR	ACS4	5EF-1D-DG-4DPWS	I3	5F-2SLX18	I15	5F-4DWS14	I14
135X-V22	ACS4	5EF-1D-DG-TMV	I3	5F-4CLX00	I12	5F-4DWS14	I14
135XM	ACS4; CP23	5EF-1D-DG-VF05	I3	5F-4CLX03A	I12	5F-4DWS14	I14
135XP	ACS6	5EF-1D-DG-V5-HG	I3	5F-4CLX05	I12	5F-4DWS14	I14
135XP-F05	ACS6	5EF-1D-DG-V5THG	I3	5F-4CLX06	I12	5F-4DWS14	I14
135XP-F22	ACS6	5EF-1D-DG-WS	I3	5F-4CLX08	I12	5F-4DWS14	I14
148X	ACS24	5EF-1D-DS	I4; J9	5F-4CLX10	I12	5F-4DWS14	I14
150A	ACS24	5EF-1D-DS-4DP	I4	5F-4CLX12	I12	5F-4DWS14	I14
150X	ACS24	5EF-1D-DS-TMV	I4	5F-4CW00	I12	5F-4DWS14	I14
151X	ACS4	5EF-1D-DS-V5-HG	I4	5F-4CW03A	I12	5F-4DWS14	I14
152X	ACS4	5EF-1D-DS-V5THG	I4	5F-4CW05	I12	5F-4DWS14	I14
				5F-4CW05A	I12	5F-4DWS14	I14

Model No.	Section & Page	Model No.	Section & Page	Model No.	Section & Page	Model No.	Section & Page
5F-4WWX10	I16	5F-8DWX08	I20	5HR-242-09	I23, 24	5PR-8W14-C	I7
5F-4WWX12	I16	5F-8DWX10	I20	5HR-232-12	I23	5PR-8W18	I7
5F-8CLX00	I18	5F-8DWX12	I20	5HR-242-GH	I23	5PR-8WLS00	I7
5F-8CLX05	I18	5F-8WLS00	I17	5HR-2HSE-25	I24	5PR-8WLS12	I7
5F-8CLX06	I18	5F-8WLS06	I17	5HR-2HSE-35	I24, 29	5PR-8WWS00	I7
5F-8CLX08	I18	5F-8WLS10	I17	5HR-2HSE-50	I24, 29	5PR-8WWS12	I7
5F-8CLX10	I18	5F-8WLS12	I17	5HR-2SA	I24	5R.M20.T449	E13
5F-8CLX12	I18	5F-8WLX00	I17	5HR-342	I22	5SL-1000	I21
5F-8CWX00	I18	5F-8WLX00-EE	I17	5HR-342-01-GH	I23	5SP-03	I30
5F-8CWX05	I18	5F-8WLX03	I17	5HR-342-09-GH	I23	5SP-03A	I30
5F-8CWX06	I18	5F-8WLX05	I17	5HR-342-GH	I23	5SP-05	I30
5F-8CWX08	I18	5F-8WLX06	I17	5HR-HDL	I29	5SP-05A	I30
5F-8CWX10	I18	5F-8WLX08	I17	5HR-HDL-L	I29	5SP-06	I30
5F-8CWX12	I18	5F-8WLX10	I17	5HR-HDL-W	I29	5SP-06A	I30
5F-8DLS00	I19	5F-8WLX12	I17	5HSE44	I28	5SP-08	I30
5F-8DLS03	I19	5F-8WLX14	I17	5HSE68	I28	5SP-08A	I30
5F-8DLS05	I19	5F-8WLX16	I17	5HSE84	I28	5SP-10	I30
5F-8DLS05A	I19	5F-8WLX18	I17	5HSE96	I28	5SP-10A	I30
5F-8DLS05CA	I19	5F-8WWS06	I18	5PR-VB	I28	5SP-12	I30
5F-8DLS06	I19	5F-8WWS12	I18	5PR-1S00	I9	5SP-12A	I30
5F-8DLS08	I19	5F-8WWX00	I18	5PR-1S06	I9	5SP-14	I30
5F-8DLS08A	I19	5F-8WWX08	I18	5PR-1S08	I9	5SP-16	I30
5F-8DLS09	I19	5F-8WWX12	I18	5PR-1S10	I9	5SP-18	I30
5F-8DLS10	I19	5F-VF05	I29	5PR-1S12	I9	5SV	I28
5F-8DLS10A	I19	5GF-8P	I21	5PR-1S14	I9	5SV-B	I28
5F-8DLS12	I19	5GF-8P-WS	I21	5PR-1S18	I9	5SV-C	I28
5F-8DLS12A	I19	5GF-12P	I21	5PR-2S00	I6	5SV-H	I22, 24, 29
5F-8DLS14	I19	5GF-16P	I21	5PR-2S00-12WB	I6	5SV-H-RK	I22
5F-8DLX00	I19	5GF-RK	I21	5PR-2S00-C	I6	5SV-RK	I28
5F-8DLX03	I19	5GF-W	I21	5PR-2S06	I6	5SV-WH	I22, 24, 27, 29; J12
5F-8DLX05	I19	5GF-W-F	I21	5PR-2S08	I6	5WG-1000-01	I22, 24, 27, 29; J12
5F-8DLX06	I19	5HDL-L	I29	5PR-2S10	I6	64L	ACS16
5F-8DLX08	I19	5HDL-W	I29	5PR-2S12	I6	66L	ACS16
5F-8DLX10	I19	5HR-2SA	I29	5PR-2S12-C	I6	67L	ACS16
5F-8DLX12	I19	5HR-222	I24	5PR-2S14	I6	98A	ACS24
5F-8DLX14	I19	5HR-222-12	I24	5PR-4D00	I5	AG-5C	F7
5F-8DLX16	I19	5HR-232	I22-24	5PR-4D08	I5	AG-5D	F7
5F-8DLX18	I19	5HR-232-01	I23, 24	5PR-4D12	I5	AG-5E	F7
5F-8DWS00	I20	5HR-232-01WE1	I27	5PR-4DLS00	I5	AG-5F	F7
5F-8DWS03	I20	5HR-232-01WE2	I27	5PR-4DLS08	I5	AG-6C	F7
5F-8DWS05	I20	5HR-232-01XE1	I27	5PR-8D00	I8	AG-6D	F7
5F-8DWS05A	I20	5HR-232-01XE2	I27	5PR-8D06	I8	AG-6E	F7
5F-8DWS05CA	I20	5HR-232-09	I23, 24	5PR-8D08	I8	AG-6F	F7
5F-8DWS06	I20	5HR-232-12	I23	5PR-8D10	I8	AG-7C	F7
5F-8DWS08	I20	5HR-232-01-GH	I23; J11	5PR-8D12	I8	AG-7D	F7
5F-8DWS08A	I20	5HR-232-GH	I23; J11	5PR-8W00	I7	AG-7E	F7
5F-8DWS09	I20	5HR-242	I22-24	5PR-8W00-C	I7	AG-7F	F7
5F-8DWS10	I20	5HR-242-01	I23, 24	5PR-8W06	I7	AG-8C-FF	F7
5F-8DWS10A	I20	5HR-242-01WE1	I27	5PR-8W08	I7	AG-8D-FF	F7
5F-8DWS12	I20	5HR-242-01WE2	I27	5PR-8W10	I7	AG-8E-FF	F7
5F-8DWS12A	I20	5HR-242-01XE1	I27	5PR-8W12	I7	AG-8F-FF	F7
5F-8DWS14	I20	5HR-242-01XE2	I27	5PR-8W12-C	I7	AG-8C-MF	F7
5F-8DWS14	I20	5HR-242-01GH	I23; J11	5PR-8W14	I7		

ACS = Accessories A = Pre-Rinse B = Pot, Kettle and Glass Filler C = Faucets and Components

CP = ChekPoint Faucets D = Institutional, Medical and Lab Products E = Washdown Stations F = Safe-T-Link Appliance Connectors

G = Parts Kits H = Emergency Equipment I = Equip J = Pet Care

Model No.	Section & Page	Model No.	Section & Page	Model No.	Section & Page	Model No.	Section & Page
AG-8D-MF	F7	B-0050-H2A	ACS29	B-0107	A4-6, 43, 53, 54;	B-0113-A12-08C	A15
AG-8E-MF	F7	B-0054-H	ACS29		E9-10, 14, 23	B-0113-A12-B08	A15
AG-8F-MF	F7	B-0054-H2A	ACS29	B-0107-035	A6, 43, 47, 53, 54	B-0113-A12-B08C	A15
AG-KC	F7	B-0054-V	ACS29	B-0107-090	A53-54	B-0113-A12B-TEE	A19
AG-KD	F7	B-0056-H	ACS29	B-0107-A	B9	B-0113-A12-V-BC	A17
AG-KE	F7	B-0056-H2A	ACS29	B-0107-B	B9	B-0113-A12B-TEE	A19
AG-KF	F7	B-0056-HMS	ACS29	B-0107-C	A4-6, 43, 53, 54	B-0113-ADFO6	A19
AG-KF	F7	B-0056-HMS	ACS29	B-0107-C35	A5, 6, 53, 55	B-0113-ADFO8-B	A19
AG-RC	F7	B-0060-H	ACS29	B-0107-C90	A5, 53, 55	B-0113-ADF10-B	A19
AW-5A	F10	B-0066-H2A	ACS29	B-0107-CM	A53, 54	B-0113-ADF12	A19
AW-5B	A54; F10	B-0068-H	ACS29	B-0107-J	A4-6, 43, 53, 55	B-0113-ADF12-B	A18, 19
AW-5C	F10	B-0068-H-SWV	A7, ACS29	B-0107-J90	A5, 53	B-0113-ADF12-BJ	A17
AW-5D	F10	B-0068-H2A	ACS29	B-0107-J-SWV	A5	B-0113-B	A18, 19
B-0015-H	ACS29	B-0068-HML	ACS29	B-0107-M	A53, 54	B-0113-B-SWV	A7, 8
B-0018-H	ACS29	B-0068-HMS	ACS29	B-0107-QD	A53, 54	B-0113-B-TEE	A18, 19
B-0018-R	ACS29	B-0068-R	ACS29	B-0108	A43, 50, 53, 55;	B-0113-B08	A15
B-0020-H	ACS29; A49	B-0072-H	ACS29		E9-10, 14, 23	B-0113-B08C	A15
B-0020-H2A	ACS29	B-0080-H	ACS29; A49	B-0108-C	A43, 50, 53, 55	B-0113-B9	A19
B-0020-HM	ACS29	B-0084-H	ACS29	B-0108-H	E9-10, 14, 22, 23	B-0113-BC	A16, 17
B-0020-R	ACS29	B-0084-V	ACS29	B-0108-HOSE	ACS29	B-0113-BJ	A17
B-0023-H	ACS29	B-0096-H	ACS29	B-0109-01	A4, 56	B-0113-BJ-SWV-T	A16,17
B-0024-H	ACS29	B-0100	A43	B-0109-01M	A56	B-0113-BM	A19
B-0024-H-SWV	ACS29	B-0100-08	A43, 44	B-0109-01VR	A56	B-0113-BR	A19
B-0024-H2A	ACS29	B-0100-08C	A43, 44	B-0109-02	A56	B-0113-C	A17
B-0026-H	ACS29	B-0100-32H	A43	B-0109-03	A56	B-0113-CBJX3HST	A17
B-0026-H2A	ACS29	B-0100-60H	A43	B-0109-03VR	A56	B-0113-CR	A19
B-0026-HM	ACS29	B-0100-C	A43, 44	B-0109-04	A56	B-0113-CR-B	A19
B-0028-H	ACS29	B-0100-C-SWV	A6-9, 43, 44	B-0109-05	A56	B-0113-CR-B8P	A10
B-0028-H2A	ACS29	B-0100-CM	A43, 44	B-0109-06	A56	B-0113-CR-B8TP	A10
B-0032-H	ACS29	B-0100-J-SWV	A7, 8, 43, 45	B-0109-07	A56	B-0113-CR-J	A17
B-0032-H2A	ACS29	B-0100-M	A43	B-0110	A56; D39	B-0113-CR-V-B	A19
B-0036-H	ACS29	B-0100-SWV	A7-9, 43, 44, 56	B-0111	A35	B-0113-CR-V-BC	A17
B-0036-H-SWV	A7, ACS29	B-0101	A43, 45	B-0111-02	A35	B-0113-J	A17
B-0036-H2A	ACS29	B-0101-60H	A43, 45	B-0111-B	A35	B-0113-K	G3
B-0040-H2A	ACS29	B-0101-A	A43, 45	B-0111-BC	A35	B-0113-M	A19
B-0042-H2A	ACS29	B-0101-A60	A43, 45	B-0111-C	A35	B-0113-SWV	A7, 19
B-0044-H	A4, 49; ACS28, 29	B-0101-A68	A43, 45	B-0112	A35	B-0113-V-BC	A17
B-0044-H-SWV	A7; ACS28	B-0101-A84	A45	B-0113	A19	B-0114-01	A38
B-0044-H2A	ACS29; B9	B-0101-E72-053A	A43	B-0113-079X-V-B	A19	B-0114-01B	A38
B-0044-H2A-SWV	A7, 44; ACS29	B-0102	B9	B-0113-08	A15	B-0114-01B-WH4	A38
B-0044-H2AML	ACS29	B-0102-A	B9	B-0113-08C	A15	B-0114-02	A38
B-0044-H2AMS	ACS29	B-0102-B	B9	B-0113-12-CR-B	A19	B-0114-RK	G3
B-0044-HF	ACS29	B-0102-C	B9	B-0113-12-CRBJ	A19	B-0117	A39
B-0044-HML	ACS29	B-0103	ACS12	B-0113-12-CRBJ	A19	B-0119	A56
B-0044-HMS	ACS29	B-0103-01	ACS12	B-0113-12-CRBJ	A19	B-0121	A35
B-0044-R	ACS28, 29	B-0103-FD10	ACS12	B-0113-12-CRBJ	A19	B-0121-12-CRBJ	A35
B-0044-R2A	ACS29	B-0103-FD12	ACS12	B-0113-12-CRBJ	A19	B-0122	A35
B-0044-RML	ACS29	B-0103-FD15	ACS12	B-0113-12-CRBJ	A19	B-0123	A22
B-0044-RMS	ACS29	B-0104	A56; B9; D52	B-0113-12-CRBJ	A19	B-0123-08	A20
B-0044-RV9	ACS29	B-0104-A	A56; B9	B-0113-12-CRBJ	A19	B-0123-08C	A20
B-0044-V	ACS29	B-0104-D	A46, 56; D52	B-0113-12-CRBJ	A19	B-0123-12-CRBJ	A10
B-0044-V9	ACS28, 29	B-0104-H	ACS29	B-0113-12-CRBJ	A19	B-0123-12-CRBJ	A10
B-0048-H	ACS29	B-0105	A46	B-0113-12-CRBJ	A19	B-0123-12-CRBJ	A10
B-0050-H	ACS29	B-0106	A43, 45	B-0113-12-CRBJ	A19	B-0123-12-CRBC	A21

Model No.	Section & Page	Model No.	Section & Page	Model No.	Section & Page	Model No.	Section & Page
B-0123-12CRBJST	A21	B-0131-BC-28H	A36	B-0133-ADF10-B	A27	B-0133-V-B	A27
B-0123-12CRCVBC	A21	B-0131-BC-425	A36	B-0133-ADF10-BR	A27	B-0133-V-B-68H	A27
B-0123-A06-B08	A20	B-0131-C	A36, 37	B-0133-ADF12	A27	B-0133-V-BC	A28
B-0123-A06-B08C	A20	B-0131-CR-B	A36	B-0133-ADF12-B	A27	B-0134	A38
B-0123-A08-B08	A20	B-0131-CR-BC28H	A36	B-0133-ADF12-BC	A28	B-0134-B	A38
B-0123-A08-B08C	A20	B-0131-CR-B08C	A36	B-0133-ADF12-BJ	A28	B-0137	A39
B-0123-A10-B08	A20	B-0132	A36	B-0133-ADF12-BM	A27	B-0140	A41
B-0123-A10-B08C	A20	B-0133	A26	B-0133-ADF12-BR	A27	B-0140-01	A41
B-0123-A12-08	A20	B-0133-01	A27	B-0133-ADF14-B	A27	B-0140-08	A41
B-0123-A12-08C	A20	B-0133-01-36H	A27	B-0133-ADF14-BR	A27	B-0141	A37
B-0123-A12-B08	A20	B-0133-01-CR	A27	B-0133-ADF16-B	A27	B-0143	A31
B-0123-A12-B08C	A20	B-0133-01-CR-8C	A25	B-0133-ADF16-BR	A27	B-0143-01	A31
B-0123-A12-V-BC	A21	B-0133-08	A24, 25	B-0133-ADF-LN	A27	B-0144-H	ACS29
B-0123-ADF06-B	A22	B-0133-08C	A24, 25	B-0133-B	A26	B-0153	A31
B-0123-ADF08	A22	B-0133-10CRBJST	A29	B-0133-B-02	A26	B-0155	A52
B-0123-ADF08-B	A22	B-0133-12-CR-B8P	A10, 11	B-0133-B-SWV	A7, 26	B-0155-01LN	A52
B-0123-ADF10-B	A22	B-0133-12-CR-B8TP	A10	B-0133-B-TEE	A26, 57	B-0155-05	A52
B-0123-ADF12	A22	B-0133-12-ACB8ST	A29	B-0133-B08	A24, 25	B-0155-05CR	A52
B-0123-ADF12-B	A22	B-0133-12-ACBJST	A29	B-0133-B08-SWV	A7, 25	B-0155-05LN	A52
B-0123-ADF12-BJ	A21	B-0133-12-ACRB8S	A29	B-0133-B08C	A24, 25	B-0155-064X	A52
B-0123-B	A22	B-0133-12-ACRB8T	A29	B-0133-B9	A26	B-0155-CR	A52
B-0123-B08	A20	B-0133-12CRBJK	A29	B-0133-BC	A28	B-0155-CR-LN	A52
B-0123-B08C	A20	B-0133-12CRBJSK	A29	B-0133-BJ	A28	B-0155-LN	A52
B-0123-B9	A22	B-0133-12CRBJST	A29	B-0133-BJ-SWV-T	A28	B-0155-LNEZ	A52
B-0123-BC	A21	B-0133-12CRVBCE	A29	B-0133-BM	A26	B-0155-LNM	A52
B-0123-BM	A22	B-0133-12-CRVBE	A27	B-0133-BQD	A26	B-0155-M	A52
B-0123-C	A21	B-0133-14-CR-B	A27	B-0133-BR	A26	B-0156	A49, 52
B-0123-CR	A22	B-0133-14-CRBJ	A29	B-0133-C	A28	B-0156-05	A52
B-0123-CR-B	A22	B-0133-14CRBJSX	A29	B-0133-CC	A26	B-0156-CR	A52
B-0123-CR-B8P	A10	B-0133-18CRBJST	A29	B-0133-CCB	A26	B-0156-EZ	A4, 52
B-0123-CR-B8TP	A10	B-0133-18DJ-CRB	A27	B-0133-CCB-CR	A26	B-0156-M	A52
B-0123-CR-BC	A21	B-0133-A06-08	A25	B-0133-CCB-M	A26	B-0157	A52
B-0123-CR-CCV-B	A22	B-0133-A06-08C	A25	B-0133-CR	A26	B-0157-05	A52
B-0123-CR-J	A21	B-0133-A08-08	A25	B-0133-CR-B	A26	B-0157-CR	A52
B-0123-J	A21	B-0133-A08-B08	A25	B-0133-CR-B08	A25	B-0157-M	A52
B-0123-M	A22	B-0133-A08-B08C	A25	B-0133-CR-B08C	A25	B-0158	A52
B-0123-V-BC	A21	B-0133-A10-08C	A25	B-0133-CR-B08W4	A25	B-0158-CR	A52
B-0124	A38	B-0133-A10-B08	A25	B-0133-CR-B8P	A10	B-0159	A56
B-0126	A40	B-0133-A10-B08C	A25	B-0133-CR-B8TP	A10	B-0160	A46
B-0126-CR	A40	B-0133-A12-08	A25	B-0133-CR-B8SWX	A7, 25	B-0163	A31
B-0126-R	A41	B-0133-A12-08C	A25	B-0133-CR-BC	A28	B-0165	A46
B-0126-VB	A40	B-0133-A12-B08	A25	B-0133-CR-BJ-SK	A28	B-0165-C35-68H	A46
B-0126-VBR	A41	B-0133-A12-B08C	A24, 25	B-0133-CR-C	A28	B-0166	A46, 56
B-0129	A40	B-0133-A12-B8CX	A25	B-0133-CR-J	A28	B-0167	A47
B-0129-VB	A40	B-0133-A12-BC4	A28	B-0133-CR-V-BCE	A28	B-0167-01	A47
B-0129-VB-08	A40	B-0133-A12-CCB	A27	B-0133-CR-V-BE	A26	B-0167-HH	A46
B-0130	A40	B-0133-A12B-TEE	A27	B-0133-EE-B	A27	B-0168	A47
B-0131	A36	B-0133-A14-CCB	A27	B-0133-EE-BM	A27	B-0169	A47
B-0131-12-CRBJK	A36, 37	B-0133-A16-CR-B	A27	B-0133-EE-CR-8C	A25	B-0169-01	A47
B-0131-ADF12-BC	A36, 37	B-0133-ADF06	A27	B-0133-J	A28	B-0169-102C-96H	A47
B-0131-ADF14-B	A36, 37	B-0133-ADF06-B	A27	B-0133-LB	A27	B-0170	A47
B-0131-B	A36, 37	B-0133-ADF08	A27	B-0133-M	A27	B-0171	A37
B-0131-BC	A36, 37	B-0133-ADF08-B	A27	B-0133-SWV	A7, 27	B-0171-01	A37

ACS = Accessories **A** = Pre-Rinse **B** = Pot, Kettle and Glass Filler **C** = Faucets and Components

CP = ChekPoint Faucets **D** = Institutional, Medical and Lab Products **E** = Washdown Stations **F** = Safe-T-Link Appliance Connectors

G = Parts Kits **H** = Emergency Equipment **I** = Equip **J** = Pet Care

Model No.	Section & Page	Model No.	Section & Page	Model No.	Section & Page	Model No.	Section & Page
B-0173	A31	B-0199-04-WS	ACS10; D70	B-0200-M	C5	B-0220-LNM	C12
B-0173-B	A31	B-0199-05-N035	ACS11; D71	B-0201	C5	B-0220-M	C12
B-0173-BC	A31	B-0199-05-N05	ACS11; D71	B-0201-01	B11	B-0221	C12
B-0173-BR	A31	B-0199-05-WS	ACS10; D70	B-0201-M	C5	B-0221-CC	C12
B-0175	A48	B-0199-06	ACS10; D70	B-0202	C5	B-0221-CC-CR	C12
B-0175-01	A48	B-0199-06-F10	ACS10; D70	B-0202-CR	C5	B-0221-CR	C12
B-0175-02	A48	B-0199-06-F12	ACS10; D70	B-0205	C7	B-0221-CR4-L22	C13
B-0175-03	A48	B-0199-06-LF10	ACS11; D71	B-0205-44H-VB	C7	B-0221-EE	C13
B-0175-CR	A48	B-0199-06-LF12	ACS11; D71	B-0205-60H-VB	C7	B-0221-KK	C13
B-0175-CRBJ-CGS	A48	B-0199-06-N035	ACS11; D71	B-0205-060X-CR	C7	B-0221-M	C13
B-0176	A48	B-0199-06-N05	ACS11; D71	B-0205-061X-CR	C7	B-0221-WH4	C13
B-0176-ER	A48	B-0199-06-WS	ACS10; D70	B-0205-CR-LN	C7	B-0222	C13
B-0177	A49	B-0199-07	ACS10; D70	B-0205-LN	A33, 37; C4, 7	B-0222-CC	C13
B-0178	A49	B-0199-07-F10	ACS10; D70	B-0205-LNM	C7	B-0222-EE	C13
B-0180	B16	B-0199-07-F12	ACS10; D70	B-0205-M	C7	B-0222-M	C13
B-0182	B16	B-0199-07-N035	ACS11; D71	B-0206	C7	B-0225	C14
B-0184	A49	B-0199-07-N05	ACS11; D71	B-0206-01	C7	B-0225-61X-CCCR	C14
B-0187	B17	B-0199-07-WS	ACS10; D70	B-0206-02	C7	B-0225-CC	C15
B-0188	B17	B-0199-08	ACS10; D70	B-0206-02-CR	C7	B-0225-CC-CR	C14
B-0190	B17	B-0199-08-F10	ACS10; D70	B-0206-CR	C7	B-0225-CR	C15
B-0192	B17	B-0199-08-F12	ACS10; D70	B-0206-M	C7	B-0225-CR-LN	C15
B-0193	B17	B-0199-08-LF10	ACS11; D71	B-0207	C7	B-0225-EELN	C15
B-0195	B17	B-0199-08-LF15	ACS11; D71	B-0207-CR	C8	B-0225-LN	C4, 15
B-0196	B17	B-0199-08-N035	ACS11; D71	B-0207-M	C8	B-0225-LN-CC-CR	C15
B-0198	ACS12	B-0199-08-N05	ACS11; D71	B-0208	C8	B-0225-LNM	C15
B-0198-FD05	ACS12	B-0199-08-WS	ACS10; D70	B-0208-CR	C8	B-0225-M	C14
B-0198-FD10	ACS12	B-0199-09	ACS10; D70	B-0208-CR-HW	C8	B-0226	C15
B-0198-FD12	ACS12	B-0199-09-F12	ACS10; D70	B-0210	C10	B-0226-CC	C15
B-0198-FD15	ACS12	B-0199-09-LF10	ACS11; D71	B-0210-060X	C10	B-0227	C15
B-0199-01	ACS10; D70	B-0199-09-LF15	ACS11; D71	B-0210-131X-CR4	C11	B-0227-CC	C15
B-0199-01-F10	ACS10; D70	B-0199-09-N035	ACS11; D71	B-0210-132XWS	C11	B-0227-M	C15
B-0199-01-F12	ACS10; D70	B-0199-09-N05	ACS11; D71	B-0210-LN	C4, 10	B-0228	C15
B-0199-01-LF12	ACS11; D71	B-0199-09-WS	ACS10; D70	B-0210-LNM	C10	B-0228-CR	C15
B-0199-01-N035	ACS11; D71	B-0199-10-N035	ACS11; D71	B-0211	C10	B-0228-M	C15
B-0199-01-N05	ACS11; D71	B-0199-10-N05	ACS11; D71	B-0212	C10	B-0230	C17
B-0199-01-WS	ACS10; D70	B-0199-10-WS	ACS10; D70	B-0212-F05	C10	B-0230-01	C17
B-0199-02	ACS10; D70	B-0199-21	ACS11; D71	B-0216	C10	B-0230-01-QT-VR	C17
B-0199-02-F10	ACS10; D70	B-0199-21-VRF	ACS11; D71	B-0216-CR	C10	B-0230-02	C17
B-0199-02-F12	ACS10; D70	B-0199-22	ACS12	B-0216-177F	C10	B-0230-14-CR-SC	C17
B-0199-02-N035	ACS11; D71	B-0199-25	ACS11; D71	B-0220	C12	B-0230-166X-CRK	C17
B-0199-02-N05	ACS11; D71	B-0199-26	ACS11; D71	B-0220-060X	C12	B-0230-BST	C17
B-0199-02-WS	ACS10; D70	B-0199-27	ACS11; D71	B-0220-166X-CRK	C12	B-0230-CC	C17
B-0199-03	ACS10; D70	B-0199-28	ACS11; D71	B-0220-61X	C12	B-0230-CC-CR	C17
B-0199-03-F10	ACS10; D70	B-0199-29	ACS11; D71	B-0220-61X-CCCR	C12	B-0230-CCLN	C17
B-0199-03-F12	ACS10; D70	B-0199-29VR	ACS11; D71	B-0220-CC	C12	B-0230-CCLNM	C17
B-0199-03-N035	ACS11; D71	B-0199-VR-KEY	ACS21	B-0220-CR	C12	B-0230-CR	C17
B-0199-03-N05	ACS11; D71	B-0200	C5	B-0220-CR-LN	C12	B-0230-CR-02	C17
B-0199-03-WS	ACS10; D70	B-0200-44H-VB	C5	B-0220-EE	C12	B-0230-CR-LN	C17
B-0199-04	ACS10; D70	B-0200-60H-VB	C5	B-0220-EE-061X	C12	B-0230-CR-SC-EK	C17
B-0199-04-F12	ACS10; D70	B-0200-CR	C5	B-0220-EELN	C12	B-0230-EE	C17
B-0199-04-LF12	ACS11; D71	B-0200-CR-LN	C5	B-0220-LN	A4, 35; C4, 12	B-0230-EE-061X	C17
B-0199-04-N035	ACS11; D71	B-0200-LN	A4, 34, 35; C4, 5	B-0220-LNCC	C12	B-0230-EELN	C17
B-0199-04-N05	ACS11; D71	B-0200-LNM	C5	B-0220-LNCCM	C12	B-0230-K	ACS26; G9; I29

Model No.	Section & Page	Model No.	Section & Page	Model No.	Section & Page	Model No.	Section & Page
B-0230-K-M12	ACS26; G9	B-0236-M	C22	B-0296	B19	B-0319-04	B11
B-0230-KIT	ACS26; G9	B-0237	C22	B-0296-LN	B19	B-0320	C14
B-0230-LN	A4, 36; C4, 17	B-0240	C23	B-0297	B19	B-0320-LN	C14
B-0230-LNM	C18	B-0240-LN	C4, 23	B-0298	B19	B-0321-CC	C14
B-0230-M	C18	B-0241	C23	B-0300	C6	B-0321-CC-CR	C14
B-0230-OSC8-CR	C18	B-0242	C23	B-0300-102A	B12	B-0321-NPL	C14
B-0230-14-CR-SC	C18	B-0243	C23	B-0300-102A-CR	B12	B-0322	D32
B-0231	C18	B-0245	C13	B-0300-A16-WD	B13	B-0322-04	D32
B-0231-02	C18	B-0246	C13	B-0300-CR	C6	B-0323-04	D32
B-0231-A22-CVH	C18	B-0247	C13	B-0300-LN	C6	B-0325	C16
B-0231-BB-CR	C18	B-0250	C5	B-0300-PF	B12	B-0325-134X-CR4	C16
B-0231-BST	C18	B-0251	C5	B-0300-VR	C6	B-0325-A22	C16
B-0231-CC	C18	B-0252	C5	B-0300-VR4	C6	B-0325-CC-CR	C16
B-0231-CC-CR	C18	B-0255	C8	B-0300-WH4	C6	B-0325-CC-CR-W4	C16
B-0231-CCM	C18	B-0255-18DJ-CR	C8	B-0301-01	C6	B-0325-CR	C16
B-0231-CR	C18	B-0257	C8	B-0301-01QT-WS	C6	B-0325-CR-WH4	C16
B-0231-CR-EK	C18	B-0260	C10	B-0301-VR	C6	B-0325-LNCC	C16
B-0231-CR-KIT	C18	B-0260-CR-177F	C10	B-0301-W4-QT-WS	C6	B-0325-NPL	C16
B-0231-CR-M	C18	B-0261	C10	B-0304	C9	B-0325-WH4	C16
B-0231-CR-SC	C18	B-0262	C10	B-0305	C9	B-0326-LN	C16
B-0231-CR-SC-F1	C18	B-0265	C19	B-0305-01	C9	B-0327	C14
B-0231-CR4-L22	C18	B-0265-BST	C19	B-0305-03	C9	B-0326-LN	C16; J4
B-0231-EE	C18	B-0266	C19	B-0305-102A-CR	B13	B-0328-CR-VF05	C16
B-0231-EE-A22	C19	B-0267	C20	B-0305-CR	C9	B-0330-01	C21
B-0231-EE-A22CR	C19	B-0267-BST	C20	B-0305-LN	C9	B-0330-01-W4F12	C21
B-0231-EEM	C19	B-0270	B10	B-0305-LN-175F	C9	B-0330-01-WH4	C21
B-0231-M	C19	B-0270-144XVF22	B10	B-0305-PF96H-CR	B13	B-0330-04	C21, D32
B-0231-VF22-EL	C19	B-0271	B10	B-0305-QT-WS	C9	B-0330-BST	C21
B-0231-WH4	C19	B-0273	E26	B-0305-TL	C9	B-0330-LN	C21
B-0232	C19	B-0273-QD	E24	B-0305-VF22	C9	B-0330CR-PRISON	C21
B-0232-BST	C19	B-0275	B10	B-0305-VR	C9	B-0331	C21
B-0232-CC	C19	B-0276	B10	B-0305-VR4	C9	B-0331-BST	C21
B-0232-CC-CR	C19	B-0281	B11	B-0305-VR4-WS	C9	B-0331-CC	C21
B-0232-EE	C19	B-0284	B18	B-0308-04	C9	B-0331-CR	C21
B-0232-ELK	C19	B-0286-LNEZ	A42; B18	B-0308-04QT-WS	C9	B-0331-CR-WH4	C21
B-0232-F1-CR-SC	C19	B-0287	A42; B18	B-0308-CR-VRS	C9	B-0331-CR4-L22	C21
B-0232-M	C19	B-0287-427-B	A42; B18	B-0308-QT-VWS	C9	B-0331-VF22-EL	C21
B-0233-01	C20	B-0287-427-BC	A42	B-0308-QT-WS	C9	B-0340-LN	C23
B-0233-02	C20	B-0289	A42; B18	B-0309	C6	B-0341	C23
B-0233-03	C20	B-0290	B18	B-0310	C11	B-0342	C23
B-0233-04	C20	B-0290-01	B18	B-0310-119X-WS	C11	B-0342-LN	C23
B-0234-BST	C19	B-0290-04	B18	B-0310-LN	C11	B-0346	C24
B-0234-EE	C19	B-0290-14	B18	B-0312	C11	B-0346-LN	C24
B-0235	C22	B-0290-K	G5	B-0314	C6	B-0350	D32
B-0235-01	C22	B-0290-LN	B18, 19	B-0315	C24	B-0350-04	D32
B-0235-61X-CREK	C22	B-0290-PRISON	B19	B-0315-LN	C24	B-0352	D32
B-0235-CC	C22	B-0291	B18	B-0316	C24	B-0352-04	D32
B-0235-LN	C4, 22	B-0292	B18	B-0316-LN	C24	B-0353-04	D32
B-0235-LNM	C22	B-0293	B19	B-0318-02	B14	B-0355-04	D32
B-0236	C22	B-0293-01	B19	B-0319	B14	B-0362	D40
B-0236-CR	C22	B-0293-14	B19	B-0319-01	B11	B-0405-02	ACS7
B-0236-CR-EK	C22	B-0294	B19	B-0319-02	B11	B-0405-03	ACS7
B-0236-CR-063X	C22	B-0295	B19	B-0319-03	B11	B-0405-04	ACS7

Model No.	Section & Page	Model No.	Section & Page	Model No.	Section & Page	Model No.	Section & Page
B-0406-02	ACS7	B-0468	ACS26	B-0541	B11	B-0650-01	D39
B-0406-03	ACS7	B-0469	ACS26	B-0542	B11	B-0650-02	D39
B-0406-04	ACS7	B-0473	D34	B-0545-F10	D37	B-0650-BSTP	D39
B-0407-02	ACS7	B-0474	D34	B-0545-F12	D37	B-0650-BSTR	D39
B-0407-03	ACS7	B-0475	D34	B-0545-F15	D37	B-0650-POL	D39
B-0407-04	ACS7	B-0475-LKS	D34	B-0545-F15-LW	D37	B-0650-RGH	D39
B-0408-02	ACS8	B-0491-01	D39	B-0545-F20	D37	B-0651-06	D40
B-0408-03	ACS8	B-0502	D33; J10	B-0546	D37	B-0651-POL	D40
B-0408-04	ACS8	B-0502-LKS	D33	B-0546-133X	D37	B-0651-RGH	D40
B-0409-02	ACS8	B-0502-SL	D33	B-0546-133X-AER	D37	B-0652	D41
B-0409-03	ACS8	B-0504	D33	B-0546-133XLF15	D37	B-0653	D48
B-0409-04	ACS8	B-0504-01	D33, 51	B-0575	B12	B-0654	D48
B-0411-F10	ACS25	B-0504-02	D33	B-0576	B12	B-0655-01	D41
B-0411-F12	ACS25	B-0504-03	D33	B-0577	B12	B-0655-02	D41
B-0411-F15	ACS25	B-0504-03SL	D33	B-0577-09	B12	B-0655-03	D41
B-0412	ACS25	B-0504-LKS	D33	B-0578-01	B12	B-0655-04	D41
B-0412-F05	ACS26	B-0504-SL	D33	B-0579	B12	B-0655-BSTP	D41
B-0412-F10	ACS26	B-0505	D33	B-0579-01	B12	B-0655-BSTP-CR	D41
B-0412-F12	ACS26	B-0505-SL	D33	B-0580	B14	B-0655-BSTR	D41
B-0412-F15	ACS26	B-0507	D33	B-0581	B14	B-0655-POL	D41
B-0412-F20	ACS26	B-0508	D33	B-0584	B14	B-0655-RGH	D41
B-0412-M	ACS25	B-0508-01	D33, 51	B-0585	B14	B-0656-POL	D41
B-0413	ACS25	B-0508-02	D34	B-0590	B14	B-0656-RGH	D41
B-0413-M	ACS25	B-0508-LKS	D33, 34	B-0591	B14	B-0657	D42
B-0413-M50	ACS23	B-0509	D34	B-0592	B14	B-0657-01	D42
B-0414	ACS25	B-0512	A37; E25	B-0592-26-CH	B14	B-0657-BST	D42
B-0414-M	ACS25	B-0513	E25	B-0592-CR	B14	B-0658	D45
B-0415	D68	B-0520	D35	B-0592-LF20	B14	B-0659	D47
B-0416	D34, 68	B-0520-01	D35	B-0592-LVR	B14	B-0660-BSTP	D42
B-0418	D68	B-0520-02	D35	B-0594	B14	B-0660-BSTR	D42
B-0423	ACS23	B-0520-F03	D35	B-0594-CR	B14	B-0660-POL	D42
B-0424	ACS23	B-0520-F05	D35	B-0597	B15	B-0660-RGH	D42
B-0425	A56; ACS23	B-0520-F07	D35	B-0597-CR	B15	B-0661-POL	D42
B-0425-M	A56; ACS23; I8, 29	B-0520-F10	D35	B-0597-EE	B15	B-0661-RGH	D42
B-0426	A56; ACS23	B-0520-F12	D35	B-0598	B15	B-0662	D43
B-0427	A56; ACS23	B-0520-F15	D35	B-0599-CR	B15	B-0664	D43
B-0428	A56; ACS23	B-0520-F20	D35	B-0600	B15	B-0664-01	D43
B-0429	A56; ACS23	B-0521	D35; J10	B-0600-36H	B15	B-0664-02	D43
B-0430	A31	B-0522	D35	B-0601	B15	B-0664-03	D43
B-0440	ACS23	B-0523	D35	B-0605	B16	B-0664-05	D43
B-0441	ACS23; D39	B-0524	D35	B-0605-CR	B16	B-0665-BSTP	D44
B-0442	ACS23	B-0525	D36	B-0605-CR-EK	B16	B-0665-BSTP-963	D44
B-0443	ACS23	B-0526-2	D36	B-0606	B16	B-0665-BSTP-CVB	D44
B-0445	ACS23	B-0526-3	D36	B-0610	B16	B-0665-BSTP-VRS	D44
B-0452	A50	B-0526-4	D36	B-0610-36H	B16	B-0665-BSTPM	D44
B-0455	C37	B-0526-5	D36	B-0610-60H	B16	B-0665-BSTPM24	D44
B-0455-04	C37	B-0526-16	D36	B-0610-CC-H108	B16	B-0665-BSTR	D44; J13
B-0455-04-963VB	C37	B-0527	D36; J10	B-0610-CR	B16	B-0665-BSTR-963	D44
B-0456	C37	B-0528	D36	B-0610-JJ	B16	B-0665-BSTR-CVB	D44
B-0456-04	C37	B-0529	D36	B-0611	B16	B-0665-BSTRM	D44
B-0456-04-963VB	C37	B-0529-01	D36	B-0618-01	D48	B-0665-BSTRM12	D44
B-0466	ACS26	B-0535	D36	B-0618-02	D48	B-0665-BSTRM24	D44
B-0467	ACS26	B-0536	D36	B-0618-03	D48	B-0665-CR-BSTP	D44

Model No.	Section & Page	Model No.	Section & Page	Model No.	Section & Page	Model No.	Section & Page
B-0665-CR-BSTR	D44	B-0695	D48	B-0736-POL	D50	B-0867-04-WS	D15
B-0665-CR-POL	D44	B-0695-ST	D48	B-0737	D50	B-0868-04	D15
B-0665-POL	D44	B-0697	D48	B-0737-POL	D50	B-0868-04L	D15
B-0665-RGH	D45	B-0698	D48	B-0800	D26	B-0869-04	D15
B-0666-POL	D45	B-0699	D48	B-0800-PA	D23	B-0870	D22
B-0666-RGH	D45	B-0699-ST	D48	B-0805	D26	B-0870-CR	D22
B-0667-POL	D45	B-0700	D49	B-0805-01	D26	B-0870-F12	D22
B-0667-POLM	D45	B-0700-01	D49	B-0805-F05	D26	B-0871	D22
B-0667-RGH	D45	B-0700-124A	D49	B-0805-PA	D23	B-0871-CR	D22
B-0667-RGHM	D45	B-0700-LT-CR-K	D49	B-0805-VF05	D26	B-0871-CR-LF05	D22
B-0667-RGHM24	D45	B-0700-LTCR177F	D49	B-0805-VR	D26	B-0871-CR-VR05	D22
B-0668-POL	D45	B-0702	D49	B-0805-VR-LDP	D26	B-0871-CR-WS	D22
B-0668-RGH	D45	B-0702-CR	D49	B-0805-VR-VF05	D26	B-0871-F05	D22
B-0669-01	D46	B-0702-WH4	D49	B-0805-WS	D26	B-0871-M	D22
B-0669-POL	D46	B-0703	D49	B-0806	D26	B-0871-VF05	D22
B-0669-RGH	D46	B-0703-124A	D49	B-0806-VR	D26	B-0871-VR-CH-QT	D22
B-0670-01	D46	B-0704	D49	B-0807	D27	B-0871-VRS	D22
B-0670-POL	D46	B-0706	D49	B-0807-01	D27	B-0871-WS	D22
B-0670-RGH	D46	B-0707	D49	B-0807-PA	D24	B-0873	D22
B-0671-POL	D46	B-0708	D49	B-0807-VR	D27	B-0874	D22
B-0671-RGH	D46	B-0708-JJ	D49	B-0807-WS	D27	B-0874-M	D22
B-0672-POL	D46	B-0709	D49	B-0830	D28	B-0885	D16
B-0672-RGH	D46	B-0709-JJ	D49	B-0831	D28	B-0890	D21
B-0673-POL	D46	B-0710	D49	B-0831-02	D28	B-0890-CR	D21
B-0673-RGH	D46	B-0710-F12	D49	B-0831-02VR	D28	B-0890-CR-LF05	D21
B-0674-BSTP	D47	B-0710-LT-CR	D49	B-0831-F05	D28	B-0890-CR-VR05	D21
B-0674-BSTPM	D47	B-0710-HW	D49	B-0831-PA	D24	B-0890-CR-WS	D21
B-0674-BSTR	D47	B-0710-WS	D49	B-0831-VF05	D28	B-0890-F05	D21
B-0674-BSTRM	D47	B-0711	D49	B-0831-VR	D28	B-0890-M	D21
B-0674-CR-BSTP	D47	B-0712	D27	B-0831-WA	D30	B-0890-VF05	D21
B-0674-CR-BSTR	D47	B-0712-01VRS	D27	B-0831-WS	D28	B-0890-VRS	D21
B-0674-CR-POL	D47	B-0712-4DP	D27	B-0833	D28	B-0890-WS	D21
B-0674-POL	D47	B-0712-F05	D27	B-0834	D28	B-0891	D21
B-0674-POLM	D47	B-0712-PA	D23	B-0834-01	D28	B-0891-F12	D21
B-0674-RGH	D47	B-0712-VF05	D27	B-0842	D27	B-0892	D19
B-0674-RGHM	D47	B-0712-VF05-4DP	D27	B-0850	D7	B-0892-01	D19
B-0674-RGHM24	D47	B-0712-WA	D30, 49	B-0850-L	D7	B-0892-01-CR	D19
B-0675	D51	B-0712-WS	D27	B-0855	D16	B-0892-01CR-L22	D20
B-0676	D51	B-0713	D27	B-0865	D15	B-0892-01-WS	D19
B-0676-54V	D51	B-0715	D50	B-0865-04	D15	B-0892-01QT	D20
B-0677	D51	B-0715-LT-CR	D50	B-0865-04-F12	D15	B-0892-122X-LAM	D19
B-0678	D51	B-0716	D50	B-0865-04L	D15	B-0892-132XV5CR	D19
B-0679	D51	B-0717	D50	B-0866	D15	B-0892-133X	D20
B-0680-ST	D51	B-0718	D50	B-0866-04	D15	B-0892-133XCRWS	D20
B-0682	D51	B-0719	D49	B-0866-04-CR	D15	B-0892-135X	D20
B-0682-ST	D51	B-0719-CR-VRS	D49	B-0866-04-LN	D15	B-0892-CR	D19
B-0685	D51	B-0720	D50	B-0866-04L	D15	B-0892-CR-HW	D20
B-0686	D51	B-0720-RGH	D50	B-0866-07-PV	D16	B-0892-CR-LF05	D19
B-0687	D52	B-0722	D50	B-0866-L	D15	B-0892-CR-WS	D19
B-0690	D52	B-0730	D50	B-0866-PV	D16	B-0892-F05	D19
B-0691	D52	B-0730-POL	D50	B-0867	D15	B-0892-F1-CR-SC	D19
B-0692	D46	B-0731-POL	D50	B-0867-04	D15	B-0892-FC	D19
B-0693-POL	D47	B-0736	D50	B-0867-04L	D15	B-0892-LF12-CR4	D20

Model No.	Section & Page	Model No.	Section & Page	Model No.	Section & Page	Model No.	Section & Page
B-0892-LF22	D19	B-1100-K	ACS26; G9	B-1117-CR	C31	B-1137	C35
B-0892-LN	D20	B-1100-LN	C26	B-1117-CR-M	C31	B-1140	C26
B-0892-M	D19	B-1100-LNM	C26	B-1117-M	C31	B-1141	C29
B-0892-QT-F05	D20	B-1100-M	C26	B-1118	C31	B-1141-01	C29
B-0892-QT-LF16	D20	B-1101	C26	B-1118-M	C31	B-1141-04-CR	C29
B-0892-QT-VF05	D20	B-1102	C26	B-1120	C32	B-1141-XS	C29
B-0892-VF05	D19	B-1103	C26	B-1120-135X-WH4	C32	B-1141-XS-F12	C29
B-0892-VRS	D19	B-1105	C27	B-1120-CR	C32	B-1141-XSCR4V05	C29
B-0892-WA	D31	B-1105-KIT	G9	B-1120-CR-LN	C32	B-1141-XSCR4V15	C29
B-0892-WS	D19	B-1105-LN	C27	B-1120-CR-LNM	C32	B-1141-XSCR4V22	C29
B-0893	D19	B-1105-LNM	C27	B-1120-LN	C32	B-1142	C37
B-0898	D22, 23, 28, 29	B-1106	C27	B-1120-LN-WH4	C32	B-1142-04	C37
B-0898-OF	D23	B-1107	C27	B-1120-LNM	C32	B-1142-VF05	C37
B-0899	D23	B-1108	C27	B-1120-M	C32	B-1142-XS	C37
B-0929	D51	B-1110	C28	B-1120-OCS6-WH4	C32	B-1145	C27
B-0929-A	D46, 48	B-1110-120X	C28	B-1120-QT-WS	C32	B-1146	C36
B-0950	A43, 45; D52	B-1110-131X-WH4	C28	B-1120-XS	C32	B-1146-01	C36; J9
B-0950-01	A43, 45; D52	B-1110-CR	C28	B-1120-XS-LN	C32	B-1146-01-CR	C36
B-0950-54H	A43, 45; D52	B-1110-CR-LN	C28	B-1120-XS-LNM	C32	B-1146-01-WS	C36
B-0950-VB	D52	B-1110-LN	C28	B-1121	C32	B-1146-01A-W4EK	C36
B-0955	A43; D52	B-1110-LN-WH4	C28	B-1121-M	C32	B-1146-02A	C36
B-0956	A43, 45; D52	B-1110-LNM	C28	B-1121-XS	C32	B-1146-02A-CR	C36
B-0957	A43; D52	B-1110-M	C28	B-1122	C32	B-1146-02A-WH4	C36
B-0962	E26	B-1110-XS	C28	B-1122-M	C33	B-1146-04	C36; J9
B-0963	E23; J13	B-1110-XS-LN	C28	B-1122-PT	C33	B-1146-04-WS	C36
B-0963-RK	E23; G10; J13	B-1110-XS-LNM	C28	B-1122-XS	C33	B-1146-2-V12-CR	C36
B-0968	A47; D51	B-1111	C28	B-1123	C33	B-1146-WS	C36
B-0968-RK01	G10	B-1111-CR	C28	B-1123-M	C33	B-1146-XS	C36
B-0969	D50	B-1111-CR-M	C28	B-1123-XS	C33	B-1147	C35
B-0969-RK01	G10	B-1111-M	C28	B-1125	C34	B-1148	C37
B-0970-01	A47, 48	B-1111-WH4	C28	B-1125-CR	C34	B-1149	C37
B-0970-FE	A57	B-1111-XS	C29	B-1125-CR-LN	C34	B-1151	C38
B-0970-FEZ	A6, 30	B-1112	C29	B-1125-CR-LNM	C34	B-1152	C38
B-0972	C41; D50	B-1112-M	C29	B-1125-LN	C34	B-1152-092A	C38
B-0973	D52	B-1112-XS	C29	B-1125-LNM	C34	B-1152-092A-VB	C38
B-0974	D52	B-1113	C29	B-1125-M	C34	B-1156	C39
B-1020	D53	B-1113-M	C29	B-1125-XS	C34	B-1156-CR	C39
B-1025	D53	B-1113-XS	C29	B-1125-XS-HM	C34	B-1157	C39
B-1025-1	D53	B-1115	C30	B-1126	C34	B-1157-12	C39
B-1025-ST	D53; E25	B-1115-131X-WH4	C30	B-1126-M	C34	B-1171	C40; J5
B-1027	D53	B-1115-132X	C30	B-1126-XS	C34	B-1171-01	C40
B-1027-UCP	D53	B-1115-132X-02	C30	B-1127	C34	B-1171-07	C40; J5
B-1028	D53	B-1115-132XN5CR	C30	B-1127-M	C34	B-1171-CR	C40
B-1029	D53	B-1115-CR	C30	B-1128	C34	B-1172	C40; J5
B-1029-1	D53	B-1115-CR-LN	C30	B-1128-M	C34	B-1172-07	C40; J5
B-1029-2	D53	B-1115-CR-LNM	C30	B-1128-XS	C35	B-1172-07-133X	C40
B-1029-PA	D53	B-1115-LN	C30	B-1130	C26	B-1172-07-WH4	C40
B-1035-ST	D51; E25	B-1115-LNM	C30	B-1131	C29	B-1172-96-135X	C40
B-1K	G5	B-1115-M	C30	B-1131-XS	C29	B-1172-CR	C40
B-10K	G3	B-1115-XS	C30	B-1132	C33	B-1172-TS	C40
B-10K-C	G4	B-1116	C30	B-1135	C27	B-1173	C40
B-10K-J	G4	B-1116-M	C30	B-1136	C31	B-1173-101-48H	C40
B-1100	C26	B-1117	C30	B-1136-CR	C31	B-1174	J9

Model No.	Section & Page	Model No.	Section & Page	Model No.	Section & Page	Model No.	Section & Page
B-1176	J9	B-1421	A49, 50	B-2278-02	A30	B-2349	A34
B-1177	C41	B-1422	A49, 50	B-2278-02-CR	A30	B-2358	C20
B-1193	C41	B-1423	A49, 50	B-2278-0440-CR	A30	B-2360	D38
B-11K	G6	B-1424	A50	B-2278-A12CRCEL	A30	B-2360-01	D38
B-1200	B6	B-1425	A50	B-2278-ADF	A30	B-2360-01-AR	D38
B-1200-M	B6	B-1426	A50	B-2278-B9	A30	B-2360-01-PA	D38
B-1201	B6	B-1427	A50	B-2278-CR	A30	B-2360-01-WFK	D38
B-1202	B6	B-1428	A50	B-2278-CR-C-EL	A30	B-2360-02	D38
B-1204	B7	B-1430	E16	B-2280	C13	B-2360-03	D38
B-1205	B7	B-1432	E16	B-2280-060X	C13	B-2360-04	D38
B-1205-M	B7	B-1433	E20	B-2280-CR	C13	B-2360-AR	D38
B-1210	B7	B-1433-01M-QDS	E16	B-2282	B10	B-2360-WFK	D38
B-1210-01	B7	B-1433-04	E16	B-2282-01	B10	B-2386	D9
B-1210-01M	B7	B-1433-7132-01M	E16	B-2282-01-F05	B10	B-2387	ACS9
B-1210-01-WFK	B4, 5	B-1433-CR	E16	B-2282-01-M10	B10	B-238RK	G7
B-1210-12	B7	B-1433-CR-QDS	E16	B-2282-F03	B10	B-23K	G7
B-1210-12-WFK	B4, 5	B-1434-RG	E16	B-2282-F05	B10	B-23K-NS	G7
B-1210-M	B7	B-1436	E17	B-2282-F07	B10	B-2403	D6
B-1210-WFK	B3-6	B-1439	E17	B-2282-F10	B10	B-2429-CR-EK	C20
B-1211	B7	B-1444	E17	B-2282-F12	B10	B-2460	D50
B-1215	B7	B-1444-CV	E17	B-2282-F15	B10	B-2464	D33
B-1220	B7	B-1453	E17	B-2282-F20	B10	B-2480	D48
B-1222	B7	B-1454	E19	B-2283	C15	B-2490	D29
B-1225	B8	B-1457	E18	B-2283-065X	C15	B-2490-PA	D24
B-1230	B8	B-1458	E18	B-2283-CR	C15	B-2490-VF05	D29
B-1230-WFK	B5	B-1459	E18	B-2285	A33	B-2490-VF05-PA	D29
B-1230-12	B8	B-1459-7132-01	E19	B-2285-B	A33	B-24K	A4, G3
B-1231	B8	B-1459-7142-01	E19	B-2285-BC	A33	B-2501	C15
B-1235	B8	B-1480	E19	B-2285-CR	A33	B-2501-CR	C15
B-1255	G10	B-16K	G3	B-2285-CR-BC	A33	B-2701	D4
B-1256	G10	B-17K	G7	B-2289	C35	B-2701-VF05	D4
B-12K	G6	B-18K	G8	B-2291	C35	B-2701-VR	D4
B-12K-T	G6	B-18KNS	G8	B-2299	C20	B-2703	D4
B-1305	D68	B-1958	D45	B-2299-CR	C20	B-2703-LF15	D4
B-1305-01	D68	B-19K	G8	B-2299-VF22-CR	C20	B-2703-VF05	D4
B-1306	D68	B-19KNS	G8	B-2301	D50	B-2710	D3
B-1306-01	D68	B-1K	G5	B-2312	B17	B-2710-F12	D3
B-1311	D68	B-20K	G6	B-2320	D20	B-2710-LH	D3
B-1336	D68	B-2180	A32	B-2331	B17	B-2710-VF05	D3
B-1340	D69	B-2187	A32	B-2338	A34	B-2710-VF22	D3
B-1341	D69	B-2187-01	A32	B-2338-08	A34	B-2710-WS	D3
B-1342	D69	B-2194	A32	B-2338-08C	A34	B-2710-WS-VR	D3
B-1344	D69	B-21K	G6	B-2338-CR	A34	B-2711	D3
B-1346	D69	B-2223	A32	B-2339	E20	B-2711-FL	D3
B-1350	D69	B-2261	A32	B-2339-02	E20	B-2711-F12	D3
B-1351	D69	B-2261-B	A32	B-2339-7122C01J	E20	B-2711-LF15	D3
B-1355	D33, 69	B-2271	D47	B-2339-7132MVBH	E20	B-2711-LH	D3
B-13K	G6	B-2271-CR	D47	B-2339-LR	E20	B-2711-VF05	D3
B-1410	A49	B-2271-POL	D47	B-2342	C20	B-2711-VF22	D3
B-1411	A49	B-2271-POL-CR	D47	B-2343	B12	B-2711-WS	D3
B-1412	A49	B-2278	A30	B-2346	C41	B-2711-WS-VR	D3
B-1413	B9	B-2278-01	A30	B-2347	D9	B-2730	D4; J5
B-1420	A49, 50; B9	B-2278-01-CR	A30	B-2347-05-LVR	D9	B-2730-07	D4; J5

Model No.	Section & Page	Model No.	Section & Page	Model No.	Section & Page	Model No.	Section & Page
B-2730-DRK	G8	B-2865-05	D17	B-2866-05CRV05	D12	B-30K	G7
B-2730-LH	D4; J5	B-2865-05-0CS8	D17	B-2866-05FC-PV	D12	B-3940	C42, 44
B-2730-WS	D4	B-2865-05-120XA	D17	B-2866-05FC-QT	D12	B-3940-M	C44
B-2730-WS-VR	D4	B-2865-05CR	D17	B-2866-05QT-VRS	D12	B-3940-XL	C44
B-2731	D4	B-2865-05CRV05	D17	B-2866-05QT-WS	D12	B-3940-XS	C44
B-2731-LF15	D4	B-2865-05CRV22	D17	B-2866-F05	D10	B-3940-01	C42, 44
B-2731-LH	D4	B-2865-05CRVL22	D17	B-2866-LF12-CR4	D10	B-3940-01M	C44
B-2731-VF05	D4	B-2865-06	D17	B-2866-QT-21VR	D10	B-3940-01-XS	C44
B-2731-WS	D4	B-2865-06CR	D17	B-2866-QT-VF05	D10	B-3942	C42, 44
B-2731-WS-VR	D4	B-2865-09CRV22	D17	B-2866-QT-VF05G	D10	B-3942-XL	C44
B-2740	D5	B-2865-09CRVL22	D17	B-2866-VF05	D10	B-3942-XS	C44
B-2741	D5	B-2865-LF05	D7	B-2867	D8	B-3942-01	C42, 44
B-2742	D5	B-2866	D10	B-2867-04	D8	B-3942-01-XS	C42, 44
B-2742-A22	D4	B-2866-04L	D17	B-2867-04L	D17	B-3945	C43
B-2742-LF05	D4	B-2866-F05	D10	B-2867-04-F05	D8	B-3950	C42, 44
B-2742-LH	D4	B-2866-LF12-CR4	D10	B-2867-04-LF15	D8	B-3950-M	C44
B-2742-VF12	D4	B-2866-QT-21VR	D10	B-2867-04-VF05	D8	B-3950-SB	C44
B-2743	D6; J5	B-2866-QT-VF05	D10	B-2867-04-WS	D8	B-3950-VR	C44
B-2744	D6	B-2866-QT-VF05G	D10	B-2867-04FC	D8	B-3950-XL	C44
B-2746	D6	B-2866-VF05	D10	B-2867-04VRS	D8	B-3950-XS	C44
B-2749	D6	B-2866-01	D11	B-2868-04	D8	B-3950-01	C42, 44
B-2760-H	D29	B-2866-01QT-VRF	D10, 11	B-2869-04	D8	B-3950-01-M	C44
B-2800-WA-KIT	G7	B-2866-04	D10	B-2885	D13	B-3950-01-M12	C44
B-2820	D29	B-2866-04L	D17	B-2990	D14	B-3950-01-SB	C44
B-2820-01	D29	B-2866-04LN	D10	B-2990-175F	D14	B-3952	C42, 44
B-2820-PA	D25, 29	B-2866-04-F12	D10	B-2990-CW-VR22	D14	B-3952-VR	C44
B-2821	D29	B-2866-04-01QT	D10	B-2990-F05	D14	B-3952-XL	C44
B-2823-02	D30	B-2866-04-QT	D10	B-2990-F12	D14	B-3952-XS	C44
B-2850	D7	B-2866-04VRS	D10	B-2990-FL	D14	B-3952-01	C42, 44
B-2850-01	D7	B-2866-05	D11	B-2990-P	D14	B-3960	C42, 45
B-2850-F05	D7	B-2866-05-F12	D11	B-2990-PWH4	D14	B-3960-XS	C45
B-2850-L	D7	B-2866-05FC10	D12	B-2990-VF05	D14	B-3960-01	C42, 45
B-2850-WH4	D7	B-2866-05FC12	D11	B-2990-WH4	D14	B-3960-01-XS	C45
B-2850-WS	D7	B-2866-05FC15	D11, 12	B-2990-WH4-F12	D14	B-3962	C42, 45
B-2851	D9	B-2866-05FC22	D11, 12	B-2990-WH4-QT	D14	B-3962-01	C42, 45
B-2851-133X-VR	D9	B-2866-05QT-VRS	D12	B-2990-WH4-VF22	D14	B-3962-01-XS	C45
B-2851-L	D9	B-2866-05QT-WS	D12	B-2990-WH4-WS	D14	B-3970	C42, 45
B-2852	D9	B-2866-05-LF08	D11	B-2990-WS	D14	B-3970-VR	C45
B-2855	D13	B-2866-05-LF12	D11	B-2991	D30	B-3970-XS	C45
B-2855-01	D13	B-2866-05-LF15	D11	B-2991-CW-VF05	D30	B-3970-01	C42, 45
B-2855-WS	D13	B-2866-05-QT	D11	B-2991-P	D30	B-3970-01-XS	C45
B-2859	D13	B-2866-05-QT-V22	D11	B-2991-PA	D25	B-3972	C42, 45
B-2862	D10	B-2866-05-VF05	D11	B-2991-PWH4	D30	B-3972-VR	C45
B-2862-LF16-WH4	D10	B-2866-05-VF22	D11	B-2991-VR	D30	B-3972-XS	C45
B-2862-QT-VR22	D10	B-2866-05VRS	D11	B-2991-WA	D31	B-3972-01	C42, 45
B-2862-VF05	D10	B-2866-05-WA	D31	B-2991-WS	D30	B-3972-01-XS	C45
B-2862-VF22	D10	B-2866-05-WS	D11, 12	B-2992	D18	B-3990	C46, 48
B-2862-WS	D10	B-2866-05CR	D12	B-2992-175F	D18	B-3990-01	C46, 48
B-2865	D7	B-2866-05CR-F15	D12	B-2992-L	D18	B-3990-01-3X	C46, 48
B-2865-04	D7	B-2866-05CR-L15	D12	B-2992-P	D18	B-3990-01-5X	C46, 48
B-2865-04-122X	D7	B-2866-05CRV05	D12	B-2992-PWH4	D18	B-3990-3KIT	C47
B-2865-04-WA	D31	B-2866-05FC	D12	B-2992-WH4	D18	B-3990-3X	C46, 48
B-2865-04L	D17	B-2866-05FC-CR	D12	B-2K-NS	G8	B-3990-5KIT	C47

Model No.	Section & Page	Model No.	Section & Page	Model No.	Section & Page	Model No.	Section & Page
B-3990-5X	C46, 48	B-7102-01M-STB	E8	B-7143-04	E9, 15	B-7242-02	E11, 15
B-3990-BSP	C46, 48	B-7102-08H	E3, 8, 15	B-7143-05	E9, 15	B-7242-05	E11, 15
B-3990-BSP3X	C46, 48	B-7102-08M	E3, 8, 15	B-7143-06	E9, 15	B-7242-08H	E11, 15
B-3990-BSP5X	C46, 48	B-7112-01	E8, 15; J11	B-7143-07	E9, 15	B-7242-10	E11, 15
B-3992	C46, 48	B-7112-01M	E8, 15	B-7161-C	E13	B-7242-C01	E12, 15
B-3992-01	C46, 48	B-7112-02	E8, 15	B-7212-01	E11, 15; J10	B-7242-C01M	E12, 15
B-3992-01-3X	C46, 48	B-7112-05	E8, 15	B-7212-01-ESB	E11	B-7242-C02	E12, 15
B-3992-01-5X	C46, 48	B-7112-08H	E8, 15	B-7212-01M	E11, 15	B-7242-C05	E12, 15
B-3992-3X	C46, 48	B-7112-08M	E8, 15	B-7212-02	E11, 15	B-7242-C08H	E12, 15
B-3992-5X	C46, 48	B-7112-10	E8, 15	B-7212-05	E11, 15	B-7245-03	E11, 15
B-3999-OF	C43	B-7122-C01	E10, 15	B-7212-08H	E11, 15	B-7245-04	E11, 15
B-3999-05XL	C43	B-7122-C01-ESB	E10	B-7212-08M	E11, 15	B-7245-06	E11, 15
B-39K	C43; G9	B-7122-C01M	E10, 15	B-7212-10	E11, 15	B-7245-07	E11, 15
B-50P	G9	B-7122-C01XS1E	E7	B-7212-11	E11, 15	B-7K	G5
B-5110-12-CRB8P	A10	B-7122-C02	E10, 15	B-7212-U01WS1E	E7	B-7K-NS	G5
B-5110-12-CRB8TP	A10	B-7122-C05	E10, 15	B-7212-U01WS2E	E7	B-8K	G6
B-5110-CR-B8P	A10	B-7122-C08H	E10, 15	B-7212-U01XS1E	E7	B-8K-NS	G6
B-5110-CR-B8TP	A10	B-7122-C08M	E10, 15	B-7212-U01XS2E	E7	B-9K	G8
B-5115-12-CRB8P	A10	B-7122-C10	E10, 15	B-7212-U01XS3	E7	B-9K-NS	G8
B-5115-12-CRB8TP	A10	B-7132-01	E8, 15; J11	B-7222-C01	E12, 15	B-CVH1-2	ACS25; A31; E24
B-5115-CR-B8P	A10	B-7132-01-ESB	E8, 14	B-7222-C01-ESB	E12, 14	B-CVH3-4	ACS25; A31; E24
B-5115-CR-B8TP	A10	B-7132-01M	E8, 15	B-7222-C01M	E12, 15	B-CVH3-8	ACS25; A31, 37
B-5120-12-B	A12, 13	B-7132-02	E8, 15	B-7222-C01XS1E	E7, 16	B-CVV1-2	E24
B-5120-12-BJ	A12, 13	B-7132-05	E8, 15	B-7222-C02	E12, 15	B-CVV3-4	A42; E26
B-5120-12-CR-B	A12, 13	B-7132-08H	E8, 15	B-7222-C05	E12, 15	B-GFE	ACS12, 24
B-5120-12-CRBJ	A12, 13	B-7132-08M	E8, 15	B-7222-C08H	E12, 15	B-GH	ACS12, 24
B-5120-12-CRB8P	A10	B-7132-10	E8, 15	B-7222-C08M	E12, 15	B-KF	A57
B-5120-12-CRB8TP	A10	B-7133	E9	B-7222-C10	E12, 15	B-KG	A57
B-5120-B	A12, 13	B-7133-01	E9, 15	B-7222-C11	E12, 15	B-LT	ACS10; D70
B-5120-BJ	A12, 13	B-7133-02	E9, 15	B-7232-01	E11, 15; J10	B-PT	ACS10; D70
B-5120-CR-B	A12, 13	B-7133-03	E9, 15	B-7232-01-ESB	E11	B-PRU-RK	G3
B-5120-CR-BJ	A12, 13	B-7133-04	E9, 15	B-7232-01M	E11, 15	B-PV	D16
B-5120-CR-B8P	A10	B-7133-05	E9, 15	B-7232-02	E11, 15	B-SD	ACS21
B-5120-CR-B8TP	A10	B-7133-06	E9, 15	B-7232-05	E11, 15	B-SDA	ACS21
B-5125-12-B	A12, 13	B-7133-07	E9, 15	B-7232-05-ESB36	E11	B-TEE-EZK	A57
B-5125-12-BJ	A12, 13	B-7142-01	E8, 15; J11	B-7232-05-ESB48	E11	B-TEE-RGD	A4, 57
B-5125-12-CR-B	A12, 13	B-7142-01M	E8, 15	B-7232-08H	E11, 15	B-VRS	D9, 22
B-5125-12-CRBJ	A12, 13	B-7142-02	E8, 15	B-7232-08M	E11, 15	B-WFC	B3-6
B-5125-12-CRB8P	A10	B-7142-05	E8, 15	B-7232-10	E11, 15	B-WFDS	B3-6
B-5125-12-CRB8TP	A10	B-7142-08H	E8, 15	B-7232-11	E11, 15	B-WFK	B3-6
B-5125-B	A12, 13	B-7142-08M	E8, 15	B-7232-U01WS1E	E7	B-WH4	ACS20; G8
B-5125-BJ	A12, 13	B-7142-10	E8, 15	B-7232-U01WS2E	E7	B-WH4-AM	ACS20
B-5125-CR-B	A12, 13	B-7142-C01	E10, 15	B-7232-U01WS3	E7	B-WH4-K	G8
B-5125-CR-BJ	A12, 13	B-7142-C01M	E10, 15	B-7232-U01WS4E	E7	B-WH4-NS	ACS20; G8
B-5125-CR-B8P	A10	B-7142-C02	E10, 15	B-7232-U01WS5	E7	B-WH4C	ACS20
B-5125-CR-B8TP	A10	B-7142-C05	E10, 15	B-7232-U01XS1E	E7, 16	B-WH4C-AM	ACS20
B-5K	G5	B-7142-C08H	E10, 15	B-7232-U01XS2E	E7	B-WH4C-NS	ACS20
B-50P	G9	B-7142-C08M	E10, 15	B-7232-U01XS3	E7	B-WH4H	ACS20
B-6K	G5	B-7142-C10	E10, 15	B-7232-U01XS4E	E7	B-WH4H-AM	ACS20
B-6RK	G5	B-7143	E9	B-7232-U01XS5	E7	B-WH4H-NS	ACS20
B-7102	E3, 8	B-7143-01	E9, 15	B-7232-U05XS1E	E7	B-WH6	ACS20
B-7102-01	E3, 8, 15	B-7143-02	E9, 15	B-7242-01	E11, 15; J10	B-WH6C	ACS20
B-7102-01M	E3, 8, 15	B-7143-03	E9, 15	B-7242-01M	E11, 15	B-WH6H	ACS20

ACS = Accessories A = Pre-Rinse B = Pot, Kettle and Glass Filler C = Faucets and Components

CP = ChekPoint Faucets D = Institutional, Medical and Lab Products E = Washdown Stations F = Safe-T-Link Appliance Connectors

G = Parts Kits H = Emergency Equipment I = Equip J = Pet Care

Model No.	Section & Page	Model No.	Section & Page	Model No.	Section & Page	Model No.	Section & Page
BF-0135-X	B21	BL-4300-01	D56	BL-5704-08WH4-VR	D61	EB-0104-H	B17
BF-0136-X	B21	BL-4300-02	D56	BL-5705-01	D61	EB-0107	E9-10, 14, 22, 23; J12
BF-0153-X	B21	BL-4350-01	D57	BL-5705-04	D61	EB-0107-035	A47, B17; J12
BF-0176	A42; B20	BL-4355-01	D57	BL-5705-08	D61	EB-0144-H	B17
BF-0178-A	B21	BL-4422-0	D56	BL-5705-08-VR	D61	EB-10K	G4; J4
BF-0299-06	B20	BL-4422-01	D56	BL-5705-09	D61	EB-1421	B17
BF-0299-08	B20	BL-4500-01	D57	BL-5707-01	D62	EB-2322	E9-10, 14, 21, 22; J12
BF-0299-10	B20	BL-4500-02	D57	BL-5707-01CRWH4	D62	EB-2322-QD	E16
BF-0299-12	B20	BL-4501-01	D57	BL-5707-01L-QT	D62	EC-3100	CP4, 6, 10
BF-0299-14	B20	BL-4520-01	D57	BL-5707-03	D62	EC-3100-120X	CP10
BF-0299-16	B20	BL-4520-02	D57	BL-5707-10	D68	EC-3100-HG	CP6, 10, 13
BF-0299-18	B20	BL-4700-01	D58	BL-5708-08WH4-VR	D61	EC-3100-LF22	CP6, 10
BF-0299-18DJ	B20	BL-4700-02	D58	BL-5709-01	D63	EC-3100-LF22-SB	CP4, 10
BF-0299-24DJ	B20	BL-4705-01	D59	BL-5709-05	D63	EC-3100-LN	CP10
BF-0400	B19	BL-4705-03	D59	BL-5709-08WH4	D63	EC-3100-SB	CP4
BF-0401	B19	BL-4710-01	D58	BL-5710-01	D64	EC-3100-SM	CP4
BF-0402	B19	BL-4710-02	D58	BL-5710-01TL	D64	EC-3100-SMT	CP11, 19
BF-PRU-RK	G3	BL-4710-03	D58	BL-5710-07	D64	EC-3100-SMT4	CP10
BL-4000-01	D54	BL-4720-01	D58	BL-5715-01	D64	EC-3100-SMT4V05	CP10
BL-4000-01M	D54	BL-4720-01MF	D58	BL-5715-08	D64	EC-3100-SMT8	CP10
BL-4005-01	D54	BL-4720-02	D58	BL-5715-09	D64	EC-3100-SMT8V05	CP10
BL-4010-01	D54	BL-4720-02MF	D58	BL-5715-09CRWH4	D64	EC-3100-TMV	CP6, 10, 13, 19
BL-4100-0	D54	BL-4720-03	D58	BL-5725-01	D64	EC-3100-TMV4VF05	CP10
BL-4100-01	D54	BL-4730-03	D58	BL-5725-08	D64	EC-3100-TMVHGF10	CP10
BL-4100-02	D54	BL-4740-03	D59	BL-5725-09	D64	EC-3100-VF05	CP6, 10
BL-4100-03	D54	BL-4750-03	D59	BL-5725-09CRWH4	D64	EC-3100-VF05-HG	CP6, 10, 20
BL-4100-04	D54	BL-4750-05	D59	BL-5735-01	D64	EC-3100-VF05THG	CP10, 20
BL-4100-05	D54	BL-4750-06	D59	BL-5735-02	D64	EC-3100-VF5-TMV	CP10
BL-4102-0	D54	BL-4750-07	D59	BL-5735-09	D64	EC-3100-XP-LF10	CP10
BL-4102-01	D54	BL-5500-0	D66	BL-5740-01	D65	EC-3101	CP4, 11
BL-4102-02	D54	BL-5500-07	D55, 56, 67	BL-5740-08	D65	EC-3101-HG	CP6, 11, 13
BL-4200-0	D55	BL-5500-09	D67	BL-5750-01	D65	EC-3101-LF22	CP6, 11
BL-4200-01	D55	BL-5500-10	D54-56, 67	BL-5755-01	D65	EC-3101-LF22-SB	CP4, 11
BL-4200-02	D55	BL-5505-07	D67	BL-5775-01	D65	EC-3101-LN	CP4, 11
BL-4200-03	D55	BL-5545-01	D67	BL-5775-08	D65	EC-3101-SB	CP4
BL-4200-04	D55	BL-5550-04	D67	BL-5800-01	D65	EC-3101-TMV	CP6, 11, 13, 19
BL-4203-0	D55	BL-5550-05	D67	BL-5800-01TL	D65	EC-3101-TMVHGF10	CP11
BL-4203-01	D55	BL-5550-09	D67	BL-5850-01	D65	EC-3101-VF05	CP6, 11
BL-4203-02	D55	BL-5550-10	D67	BL-5850-01TL	D65	EC-3101-VF5-TMV	CP11
BL-4203-04	D55	BL-5550-12	D67	BL-6000-02	D66	EC-3101-XP-LF10	CP11
BL-4210-0	D55	BL-5550-23	D67	BL-6000-03	D66	EC-3102	CP4, 6, 12
BL-4210-01	D55	BL-5550-30	D68	BL-6005-02	D66	EC-3102-4DP	CP6
BL-4210-02	D55	BL-5560-01	D68	BL-6005-03	D66	EC-3102-8DP	CP6
BL-4210-04	D55	BL-5560-02	D68	BL-6050-01	D66	EC-3102-HG	CP6, 12, 13
BL-4250-01	D55	BL-5561-02	D68	BL-6050-02	D66	EC-3102-LF22	CP6, 12
BL-4250-02	D56	BL-5561-03	D68	BL-9005-01	D59	EC-3102-SM	CP6, 12
BL-4250-03	D56	BL-5700-01	D60	BL-9505-01	D66	EC-3102-SMT	CP11, 19
BL-4250-05	D56	BL-5700-04	D60	BL-9505-02	D66	EC-3102-SMT4	CP12
BL-4250-06	D56	BL-5700-08	D60	BL-9515-01	D66	EC-3102-SMT4V05	CP12
BL-4250-07	D56	BL-5700-08-VR	D60	BL-9515-02	D66	EC-3102-SMT8	CP12
BL-4250-08	D56	BL-5700-09	D60	BR-10	A57	EC-3102-SMT8V05	CP12
BL-4260-01	D56	BL-5704-05	D61	EB-0068-H	A47	EC-3102-TMV	CP6, 12, 13
BL-4300-0	D56	BL-5704-08WH4	D61	EB-0096-H	J5	EC-3102-TMV4V05	CP12

ACS = Accessories **A** = Pre-Rinse **B** = Pot, Kettle and Glass Filler **C** = Faucets and Components

CP = ChekPoint Faucets **D** = Institutional, Medical and Lab Products **E** = Washdown Stations **F** = Safe-T-Link Appliance Connectors

G = Parts Kits **H** = Emergency Equipment **I** = Equip **J** = Pet Care

Model No.	Section & Page	Model No.	Section & Page	Model No.	Section & Page	Model No.	Section & Page
EC-3102-VF05	CP6 , 12	EC-3142-ST-VF05	CP18	HG-2C-72	F5-8	HG-4C-72K	F5-8
EC-3102-VF05-HG	CP6 , 12, 20	EC-3142-STV5THG	CP5 , 18, 20	HG-2C-72K	F5-8	HG-4C-72S	F5-8
EC-3102-VF05THG	CP12 , 20	EC-3142-VF05	CP3 , 5, 18	HG-2D-24	F5-8	HG-4D-24	F5-8
EC-3102-VF5-TMV	CP12	EC-ADEWIRE	CP7 , 21	HG-2D-24K	F5-8	HG-4D-24K	F5-8
EC-3103	CP4 , 6, 13	EC-EASYWIRE	CP7 , 21	HG-2D-24S	F5-8	HG-4D-24S	F5-8
EC-3103-HG	CP6 , 13	EC-EASYWIRE4CC	CP7 , 21	HG-2D-24SK	F5-8	HG-4D-24SK	F5-8
EC-3103-LF22	CP6 , 13	EC-EASYWIRE5EXT	CP7 , 21	HG-2D-36	F5-8	HG-4D-36	F5-8
EC-3103-TMV	CP6 , 13	EC-FILTER	CP19	HG-2D-36K	F5-8	HG-4D-36K	F5-8
EC-3103-VF05	CP6 , 13	EC-HARDWIRE	CP7 , 21	HG-2D-36S	F5-8	HG-4D-36-PS	F5-8
EC-3103-VF05-HG	CP6 , 13, 20	EC-HYDROGEN	CP8-9 , 19	HG-2D-36SK	F5-8	HG-4D-36K-PS	F5-8
EC-3103-VF05THG	CP13 , 20	EC-HYDROGEN-LF	CP8-9 , 19-20	HG-2D-48	F5-8	HG-4D-36S	F5-8
EC-3103-VF5-TMV	CP13	EC-SMT	CP7-8 , 19	HG-2D-48K	F5-8	HG-4D-36SK	F5-8
EC-3104	CP4 , 14	EC-TMV	CP7-8 , 19	HG-2D-48S	F5-8	HG-4D-36SK-PS	F5-8
EC-3104-HG	CP6 , 14	ECR-D0810-107	CP24	HG-2D-48SK	F5-8	HG-4D-48	F5-8
EC-3104-LF22	CP6 , 14	EMV-0522-24	I27	HG-2D-60	F5-8	HG-4D-48K	F5-8
EC-3104-LMV	CP14	EW-7360B	H4 ; J14	HG-2D-60S	F5-8	HG-4D-48-PS	F5-8
EC-3104-TMV	CP6 , 14	EW-7360B-TMV	H5 ; J14	HG-2D-60SK	F5-8	HG-4D-48K-PS	F5-8
EC-3104-VF05	CP6 , 14	EW-7501	H4 ; J14	HG-2D-72	F5-8	HG-4D-48S	F5-8
EC-3104-VF05-HG	CP6 , 14, 20	EW-7611	H4 ; J14	HG-2D-72K	F5-8	HG-4D-48S-PS	F5-8
EC-3104-VF05THG	CP14 , 20	EW-7612	H4 ; J14	HG-2D-72S	F5-8	HG-4D-48SEL-PS	F5-8
EC-3104-VF5-TMV	CP14	EW-7612LH	H4 ; J14	HG-2D-72SK	F5-8	HG-4D-48SK	F5-8
EC-3105	CP4 , 15	EW-8904	H5 ; J14	HG-2E-36	F5-8	HG-4D-48SK-PS	F5-8
EC-3105-HG	CP6 , 15	EW-9082	H4	HG-2E-36K	F5-8	HG-4D-60	F5-8
EC-3105-LF22	CP6 , 15	EW-9095	H5	HG-2E-36S	F5-8	HG-4D-60-PS	F5-8
EC-3105-LMV	CP15	EW-9201EF	H5	HG-2E-36SK	F5-8	HG-4D-60K	F5-8
EC-3105-LN	CP15	EW-SP90	H6	HG-2E-48	F5-8	HG-4D-60S	F5-8
EC-3105-TMV	CP6 , 15	EW-SP131	H6	HG-2E-48K	F5-8	HG-4D-60S-PS	F5-8
EC-3105-VF05	CP6 , 15	EW-SP140	H6	HG-2E-48S	F5-8	HG-4D-60SK	F5-8
EC-3105-VF12	CP15	EW-SP170	H6	HG-2E-48SK	F5-8	HG-4D-60SK-PS	F5-8
EC-3130	CP3 , 5, 16	EW-SP21FC	H6	HG-2E-60	F5-8	HG-4D-72	F5-8
EC-3130-4DP	CP5 , 16	EW-SP225	H6	HG-2E-60K	F5-8	HG-4D-72K	F5-8
EC-3130-8DP	CP3 , 5, 16	EW-SP509	H6	HG-2E-60S	F5-8	HG-4D-72S	F5-8
EC-3130-HG	CP5 , 16	EZ-K	G9	HG-2E-72	F5-8	HG-4D-72SK	F5-8
EC-3130-LF22	CP5 , 16	EZ-SWIVEL-CZ	ACS25	HG-2E-72K	F5-8	HG-4E-36	F5-8
EC-3130-LN	CP16	EZ-SWIVEL-FM	ACS25	HG-2E-72S	F5-8	HG-4E-36K	F5-8
EC-3130-ST-VF05	CP16	G016590-45	E24	HG-2F-48	F5-8	HG-4E-36S	F5-8
EC-3130-STV5THG	CP16 , 20	G016652-45	E9-10 , 13, 14	HG-2F-48K	F5-8	HG-4E-36SK	F5-8
EC-3130-VF05	CP5 , 16	G016682-45	I24	HG-2F-48SK	F5-8	HG-4E-48	F5-8
EC-3130-XP-F10	CP16	G016684-45	I24	HG-4C-36	F5-8	HG-4E-48K	F5-8
EC-3130-XP-F15	CP16	G018477-45	E9-10 , 13, 14; J13	HG-4C-36K	F5-8	HG-4E-48K-PS	F5-8
EC-3132	CP3 , 5, 17	G018682-45	I24	HG-4C-36S	F5-8	HG-4E-48S	F5-8
EC-3132-4DP	CP3 , 5, 17	G018684-45	I24	HG-4C-36SK	F5-8	HG-4E-48S-RC	F5-8
EC-3132-8DP	CP5 , 17	G019430-45	E9-10 , 13, 14; J13	HG-4C-48	F5-8	HG-4E-48SK	F5-8
EC-3132-HG	CP5 , 17	HG-2C-36	F5-8	HG-4C-48K	F5-8	HG-4E-48SK-PS	F5-8
EC-3132-LF22	CP5 , 17	HG-2C-36-PS	F5-8	HG-4C-48S	F5-8	HG-4E-60	F5-8
EC-3132-ST-VF05	CP17	HG-2C-36K	F5-8	HG-4C-48K-PS	F5-8	HG-4E-60K	F5-8
EC-3132-STV5THG	CP17 , 20	HG-2C-36S	F5-8	HG-4C-48SK	F5-8	HG-4E-60S	F5-8
EC-3132-VF05	CP5 , 17	HG-2C-48	F5-8	HG-4C-48SK-PS	F5-8	HG-4E-60SK	F5-8
EC-3142	CP3 , 5, 18	HG-2C-48-PS	F8	HG-4C-60	F5-8	HG-4F-48	F5-8
EC-3142-4DP	CP3 , 5, 18	HG-2C-48K	F5-8	HG-4C-60K	F5-8	HG-4F-48K	F5-8
EC-3142-8DP	CP3 , 5, 18	HG-2C-48S	F5-8	HG-4C-60S	F5-8	HG-4F-48S	F5-8
EC-3142-HG	CP3 , 5, 18	HG-2C-48SK	F5-8	HG-4C-60SK	F5-8	HG-4F-48SK	F5-8
EC-3142-LF22	CP3 , 5, 18	HG-2C-60	F5-8	HG-4C-72	F5-8	HG-4F-60	F5-8

ACS = Accessories **A** = Pre-Rinse **B** = Pot, Kettle and Glass Filler **C** = Faucets and Components

CP = ChekPoint Faucets **D** = Institutional, Medical and Lab Products **E** = Washdown Stations **F** = Safe-T-Link Appliance Connectors

G = Parts Kits **H** = Emergency Equipment **I** = Equip **J** = Pet Care

Model No.	Section & Page	Model No.	Section & Page	Model No.	Section & Page	Model No.	Section & Page
HG-4F-60K	F5-8	MV-1907-12C	E26	PG-8DSAV-06	J7		
HG-4F-60S	F5-8	MV-1907-12CW	E27	PG-8DSAV-08	J7		
HG-4F-60SK	F5-8	MV-2516	E21, 22	PG-8DSAV-10	J7		
HG-6D-48	F5-8	MV-2516-21	E21	PG-8DSAV-12	J7		
HG-6D-72	F5-8	MV-2516-22	E21	PG-8DSAV-14	J7		
HG-SD-36	F5-8	MV-2516-24	E9-10, 14, 21	PG-8DSAV-16	J7		
HG-SD-48	F5-8	MV-2516-31	E21	PG-8DSAV-18	J7		
HW-2B-24	F10, 11	MV-2516-32	E21	PG-8WESV00ZCJZF	J6		
HW-2B-36	E19; F10, 11	MV-2516-34	E9-10, 14, 21	PG-8WESV08ZCJZF	J6		
HW-2B-48	F10, 11	MV-2516-41	E21	PG-8WOAN-06	J8		
HW-2B-72	F10, 11	MV-2516-42	E21	PG-8WOAN-08	J8		
HW-2C-36	F10, 11	MV-2516-44	E9, 10, 14, 21	PG-8WOAN-10	J8		
HW-2C-48	F10, 11	MV-2522	E21, 22	PG-8WOAN-12	J8		
HW-2C-60	F10, 11	MV-2522-21	E21	PG-8WOAN-14	J8		
HW-2C-72	F10, 11	MV-2522-22	E21	PG-8WOAN-16	J8		
HW-2D-48	F10, 11	MV-2522-24	E9-10, 14, 21; J12	PG-8WOAN-18	J8		
HW-4B-24	E20; F10, 11	MV-2522-31	E21	PG-8WREV	J4		
HW-4B-36	E18; F10, 11	MV-2522-32	E21	PG-8WSAV	J4		
HW-4B-48	F10, 11	MV-2522-34	E9, 10, 14, 21	PG-8WSAV-06	J4, 8		
HW-4B-72	F10, 11	MV-2522-41	E21	PG-8WSAV-08	J8		
HW-4B-72VB	F10, 11	MV-2522-42	E21	PG-8WSAV-10	J8		
HW-4C-36	F10, 11	MV-2522-44	E9, 10, 14, 21	PG-8WSAV-12	J8		
HW-4C-48	F10, 11	MV-3516-21	E21	PG-8WSAV-14	J8		
HW-4C-60	F10, 11	MV-3516-22	E21	PG-8WSAV-16	J8		
HW-4C-72	F10, 11	MV-3516-24	E9, 10, 14, 21	PG-8WSAV-18	J8		
HW-4C-72VB	F10, 11	MV-3516-25	E21, 22; J12	PG-8WREV	J4		
HW-4D-48	F10, 11	P3-8DESV00NCJZF	J5	POSI-SET™	F3, 6-8		
HW-6C-36	F10, 11	P3-8WESV-08M	J5	SQ-0093	A57		
HW-6C-48	F10, 11	PA-B	ACS21	VRS-2	D8, 20-22		
HW-6D-48	F10, 11	PA-C	ACS21				
MPJ-4CLN-08-CR	A12, 13	PA-H	ACS21				
MPJ-8CLN-08-CR	A12, 13	PG-0001	J4				
MPZ-2DLN-06	A6	PG-0002	J4				
MPZ-2DCN-06	A6	PG-0003	J4				
MPZ-2DLN-06	A6	PG-1DREV	J4				
MPZ-8WCN-06	A6	PG-1WSAV-06	J4				
MPZ-8WLN-06	A6	PG-1WESV-FS	J6				
MPZ-KIT-LN06	A6	PG-35AV	J4				
MPZ-KIT-LN06-CR	A6	PG-35AV-CH	J4				
MV-0771-11CW	E26	PG-35AV-CH01	J4				
MV-0771-11NW	E26	PG-35AV-CH02	J4				
MV-0771-12C	E26; J13	PG-35AV-CH03	J4				
MV-0771-12CW	E26; J13	PG-35AV-CH05	J4				
MV-0771-12N	J13	PG-4DREV	J4				
MV-0771-12N-BV	E27	PG-8DESV00ZCJZF	J6				
MV-0771-12N-BVT	E27	PG-8DREV	J4				
MV-0771-12NW	E26; J13	PG-8DSAN-06	J7				
MV-0771-12R	E26	PG-8DSAN-08	J7				
MV-0771-12R-VB	E26	PG-8DSAN-10	J7				
MV-1907-04C	E27	PG-8DSAN-12	J7				
MV-1907-11C	E26	PG-8DSAN-14	J7				
MV-1907-11CW	E27	PG-8DSAN-16	J7				
MV-1907-11CW-ER	E27	PG-8DSAN-18	J7				

SMALL PARTS. BIG IMPACT.

Ensuring efficient operation starts with selecting the right fixtures and parts.

When you choose high-quality sustainable products from T&S, you're not just ensuring reliable, worry-free performance – you're driving down water and energy costs with every installation.

While T&S offers a full range of water-saving fixtures, here are three key product categories that can yield particularly large savings for a relatively small investment:

SPRAY VALVE SAVINGS

available in several designs for specific applications, like the ultra low-flow B-0107-C (0.65 GPM), the B-0107-J (1.07 GPM) or the B-0108-C (0.65 GPM)



AERATOR SAVINGS

the ideal choice to limit the outlet's water flow, with a variety of flow patterns and rates available



CARTRIDGE SAVINGS

T&S' water-saving Cerama cartridges reduce water usage by up to 20% and come with a lifetime warranty



SUSTAINABILITY



**B-0107-J
SPRAY VALVE
1.07 GPM @ 60 PSI**

**CERAMA
CARTRIDGES**

B-0133-12-CRBJST





RELIABILITY BUILT IN™

www.tsbrass.com

T&S BRASS AND BRONZE WORKS, INC.

U.S. CUSTOMER SERVICE EMAIL customerservice@tsbrass.com

U.S. Toll-free +1-800-476-4103 • U.S. Main Office +1-864-834-4102 • U.S. Fax +1-800-868-0084

8:00 a.m. – 8:00 p.m. EST

2 Saddleback Cove • Travelers Rest, South Carolina 29690 U.S.A.

INTERNATIONAL CUSTOMER SERVICE EMAIL internationalsales@tsbrass.com

Main Office +1-864-834-4102 • Canada Toll-free +1-888-288-0432

T&S BRASS U.S.A. – WEST COAST

U.S. CUSTOMER SERVICE EMAIL customerservice@tsbrass.com

U.S. Toll-free Customer Service +1-800-423-0150 • U.S. Fax +1-800-273-7718

8:00 a.m. – 8:00 p.m. EST

4596 Ish Drive • Unit 220 • Simi Valley, California 93063 U.S.A.

T&S BRASS ASIA

CHINA CUSTOMER SERVICE EMAIL csasia@tsbrass.com

China Customer Service +86-400-1096-026 • China Office +86-21-3122-9550

China Fax +86-21-3122-9551

No. 43 Jinwen Road • Zhuqiao Town • Pudong New District • 201323 Shanghai, P.R.C.

