

SMALLWARES & COUNTERTOP EQUIPMENT



Experience

VOLLRATH

Your work impacts how people experience a meal. Whether you're serving food in a hospital cafeteria, a high-end restaurant, a busy university, or another setting, Vollrath can help you make those experiences better, more efficient, and more inspired.

On the pages that follow, you'll find our selection of smallwares and countertop equipment including everything from color-coded ladles to merchandising and display cases. But that's not all we design and manufacture at Vollrath. Vollrath also offers modular serving stations, custom-fabricated kiosks, and even complete custom build-outs.

LEARN MORE ABOUT HOW VOLLRATH CAN MAKE YOUR JOB EASIER AND HELP MAINTAIN THE QUALITY OF YOUR FOOD BY REQUESTING THESE PIECES AT VOLLRATH.COM/CATALOGS.



BRAND BOOK



**SERVING SYSTEMS
& COMPONENTS**

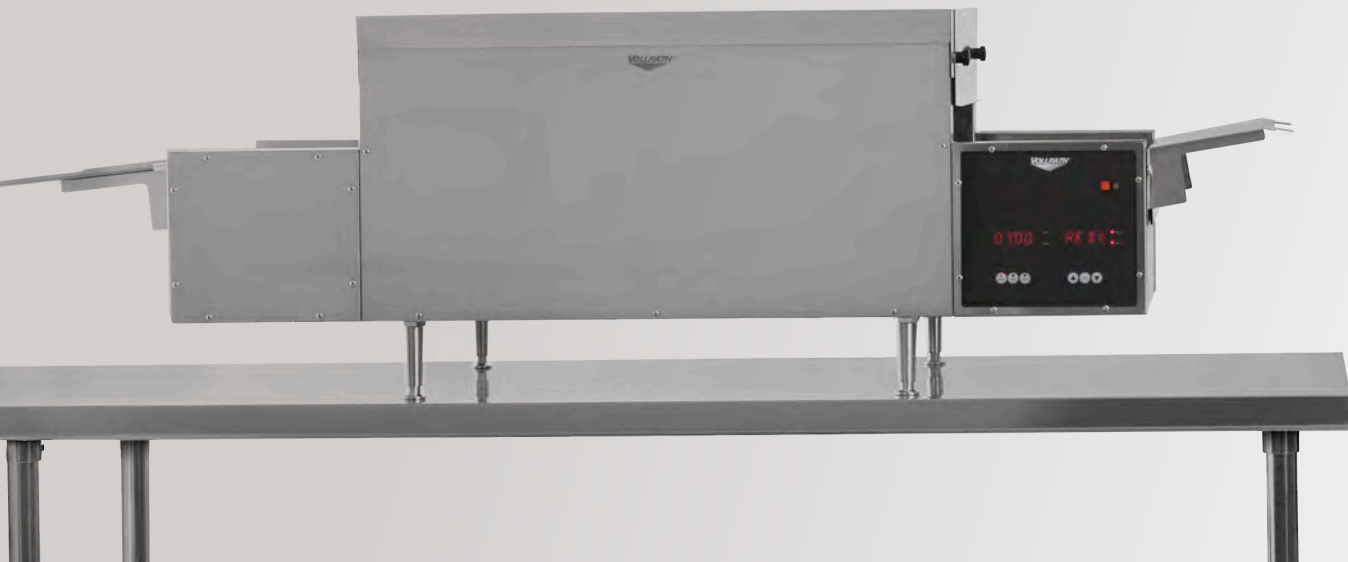



FOOD PREPARATION EQUIPMENT

Pages 8-25



COOKING EQUIPMENT

Pages 26-49



WARMING EQUIPMENT

Pages 50-65



MERCHANDISING & DISPLAY SOLUTIONS

Pages 66-75



FROZEN TREAT EQUIPMENT

Pages 76-79



STEAM TABLE PANS & ACCESSORIES

Pages 80-101



COOKWARE & BAKEWARE

Pages 102-137



KITCHEN ESSENTIALS

Pages 138-175



BUFFET & TABLETOP SERVICE

Pages 176-251



WAREWASHING & HANDLING

Pages 252-293



DISPENSING SOLUTIONS

Pages 294-309



FOOD DELIVERY & TRANSPORT

Pages 310-317

Discover

LEADERSHIP

Vollrath doesn't just help you outperform every day. We also take on that same challenge ourselves by continuing to lead the industry with innovative products designed to help you compete and thrive. Add one of our award-winning products to your line.

Foodservice Equipment and Supplies Magazine: Best In Class

Foodservice Equipment and Supplies Magazine: Best In Class

Foodservice Equipment and Supplies Magazine: Best In Class

Foodservice Equipment and Supplies Magazine: Best In Class



BUFFET & TABLETOP SERVICE

Pages 176-251

INDUCTION RANGES

Pages 29-33

MANUAL FOOD PROCESSORS

Pages 11-19

COOKWARE

Pages 102-137

BEST IN CLASS AWARDS FOR FOODSERVICE EQUIPMENT & SUPPLIES

- Cookware (Overall) – 13 years in a row
- Induction Cooktops (Operators) – 12 years in a row
- Manual Food Processors (Overall) – 8 years in a row
- Buffet & Tabletop Accessories (Overall) – 7 years in a row

NRA KITCHEN INNOVATIONS AWARDS

- 2016 – Stoelting® AutoVend Self-Serve Soft-Serve Vending Machine
- 2014 – Induction Cooking Station with Downdraft Vent Module
- 2013 – Mirage® Induction Rethermalizer



*Foodservice Equipment
Reports Magazine:
Smallwares Award*



**CONTEMPORARY
HINGED LID**

Page 99

*Foodservice Equipment
Reports Magazine:
Tabletop Award*



**CUBIC MODULAR
DISPLAY SYSTEM**

Pages 183-188

*Foodservice Equipment
Reports Magazine:
Smallware Award*



**LIDSAVER™ 2
DISPENSERS**

Pages 296-300

*NRA Kitchen: Innovation
Award & IHMRS Show:
Best New Product Award*



**MIRAGE® INDUCTION
RETHEMALIZER**

Page 56



SERVING SYSTEMS & COMPONENTS

We know creating a custom design involves a lot of decisions – and it can be time consuming to get approval from your whole team. We'll help you through every step of the process. Get a copy of our Serving Systems & Components brochure today and let's start building something beautiful together.



Request your copy today by visiting VOLLRATH.com/catalogs.



CART



Completely self-contained, carts are mobile, modular pieces designed to work alone or together. They can be moved as needed and provide excellent flexibility. Carts are perfect for expanding your foodservice offering or adding auxiliary service.

KIOSK



Designed for a fixed setting, kiosks are fully enclosed structures with larger electrical systems than carts. Kiosks can be secondary foodservice solutions or used on their own.

SERVING LINE

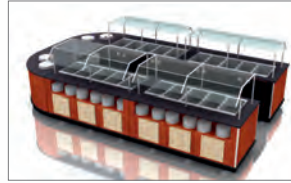

Designed for either a long single line or a more modular design, serving lines are an option for buffet or full service. They typically focus on a particular type of food such as a salad bar, hot foods, or cold foods.

MERCHANDISING UNIT



Much larger than kiosks, merchandising units typically have their own floor and are approximately 15-20' long and 8-10' deep. They work well for pop-up food service as well as merchandise shops and, while designed to be semi-permanent, can be moved with large equipment.

Common serving system locations



Educational Institutions



Travel and Leisure Environments



Business and Industry Facilities



Health Care Locations



Grocery and Convenience Stores



Restaurants and Bars



Serving System Series

COMPARISON

For product specifications, visit VOLLRATH.com/SS, AutoQuotes, or KCL.



6-Series // V-CLASS CUSTOM

Fully customizable with extensive material options, 6-Series systems are designed, engineered, and manufactured to meet your specific requirements.

CUSTOMIZATION

★★★★★ Custom Fabricated

WARRANTY

2 TWO YEAR WARRANTY

2-year parts & labor warranty

COST

\$\$\$

NOTABLE OPTIONS

Custom fabrication of canopies and complete merchandising including: signage and menu boards, integrated plate storage, backlit signage, 3-D graphics, façades and single-point electrical connection

DÉCOR OPTIONS



Hundreds of laminates, veneers, vinyl graphics, custom-matched automotive-grade paint, or 3-D façades graphics

BASE CONSTRUCTION OPTIONS



Aluminum Composite



Stainless Steel



Wood



Wood Composite

COUNTERTOP MATERIAL OPTIONS



Man-Made Quartz



Acrylic Solid Surface



Stainless Steel



Laminate

BREATH GUARDS

Vollrath-branded and all other major breath guard brands, including all lighting and heat options

All units are made to order and cannot be returned or canceled



4-Series // SIGNATURE SERVER®

These modular designs offer size, shape, and material options, but they are not fully customizable.



2-Series // AFFORDABLE PORTABLE™

Designed for the budget-conscious organization, 2-Series systems offer a choice of two sizes and seven colors.

★★★★ Standard items with modifications

★★ Standard items

1 ONE YEAR WARRANTY

2 TWO YEAR WARRANTY

1-year parts & labor warranty (2-year optional)

1 ONE YEAR WARRANTY

1-year parts & labor warranty

\$\$

\$

Modifications including: storage, countertops with different drop-in combinations, fill faucets

Storage, lighting, breath guards

Vinyl graphics, hundreds of laminate options, or stainless steel

Seven standard colors



Stainless Steel



Wood



Vinyl-Clad Carbon Steel



Acrylic Solid Surface



Stainless Steel



Laminate



Stainless Steel

Available with countertop-mounted breath guards; LED, fluorescent, or incandescent lighting; and heat strips

Standard countertop-mounted buffet and cafeteria-style breath guards only

All units are made to order and cannot be returned or canceled

All units are made to order and cannot be returned or canceled

The Vollrath Company, L.L.C.
1236 North 18th Street
Sheboygan, WI 53081-3201

Main Tel: 920-457-4851
Fax: 800-752-5620 or
920-459-6573

Customer Service: 800-628-0830
Credit: 920-459-5387
Canada Customer Service: 800-695-8560
Technical Services: 800-628-0832

vollrath.com



©2019 The Vollrath Company, L.L.C. | An ISO 9001 Certified Company | Form No. 134567 (English) | Printed in USA

Learn at

VOLLRATH UNIVERSITY

One way Vollrath helps you outperform every day is with a vast collection of industry-leading products. Another is Vollrath University, the industry's best-in-class training resources for foodservice professionals. Whether it's at our world-class on-site training facility or online, Vollrath University can help you increase efficiency, drive profitability, and kindle inspiration, no matter what your industry role.

ON-SITE

- 13,000-square-foot world-class training facility
- Hands-on workstations
- Customizable training programs
- Manufacturing facility tours

ONLINE

- Helpful guides and reference materials
- Informational training videos
- Product tutorials
- Culinary support and recipes

Take advantage of Vollrath University, and arm yourself with everything you need to elevate your offering.



FOR MORE INFORMATION, VISIT
VOLLRATHUNIVERSITY.COM



Symbol LEGEND



Denotes items manufactured at one of our US facilities



Denotes NSF-certified items



Denotes items with antimicrobial treatment – see VOLLRATH.COM



Denotes new item



Denotes Direct Contact Heating System



Denotes product approvals by the respective organizations



Denotes items with Limited Lifetime Warranty



Denotes items with 2-year warranty



Denotes items with 3-year warranty



Visit VOLLRATH.COM

Denotes additional information located at VOLLRATH.COM



Induction



Electric



Gas



Note: In the interest of continued product improvement, Vollrath reserves the right to change specifications without notice. Prices and availability are also subject to change without notice.

Dimensions listed in this catalog are approximate and may vary. Contact your Vollrath representative for specific drawing details.



FOOD PREPARATION EQUIPMENT

Before it ever hits a plate, every meal begins with equal parts planning, passion, and prowess. Food preparation equipment from Vollrath will help you capitalize on all three. Food prep equipment can streamline your kitchen to make you more efficient and focused on the task at hand.



“With 210 different students working with our mixers, it is a must they can withstand the abuse. Vollrath mixers provide the quality and value we demand.”

MICHAEL PIERINI

Chef Instructor,
Culinary Program Director
Cerritos College

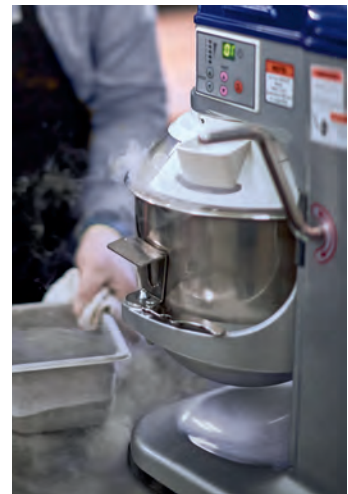

How to Shop

FOOD PREPARATION EQUIPMENT

Manual Food Processors



Save significant labor costs slicing, dicing, and wedging by using a food processor instead of cutting by hand. Our food processors also increase food yield and allow for more consistent cuts.

[Pages 11-19](#)

Grinders



Vollrath grinders feature stainless steel construction and come standard with a sausage stuffer and feed stick.

[Page 19](#)

Can Openers



Get the cleanest, most hygienic cut ever with our EaziClean®, Premium™, and CanMaster™ can openers.

[Page 20](#)

Mixers



Designed for heavy use, our durable mixers come standard with a stainless steel mixing bowl, dough hook, wire whisk, and flat beater.

[Pages 21-22](#)

Slicers



Our slicers lead the industry in performance and durability. They're available in three blade sizes and feature nonstick coating.

[Pages 23-24](#)

Vacuum Packing



Extend the shelf life of food and cut down on waste due to spoilage with a vacuum sealer. Vacuum sealing quickly marinates meats and when paired with the Sous Vide immersion circulator becomes the total package.

[Page 25](#)

MANUAL FOOD PROCESSORS



2 TWO YEAR WARRANTY



15000



15604



700-1



403NH

- Achieve significant labor savings when compared to cutting by hand
- Higher food quality – no browning or bruising
- Allows for consistent product with every cut
- Increased food yield

MANUAL FOOD PROCESSORS

- Vegetable slicers/dicers/wedgers
- Lettuce choppers/shredders
- Tomato slicers
- Cheese slicers and cubers
- Seafood cutters
- Potato cutters/scoopers
- Grill accessories

watch it on VOLLRATH.com/mfp



Visit VOLLRATH.com/mfp to get an inside look at how Chef Rich brings locally grown fruits and vegetables to the table with greater consistency and speed.

NEW InstaCut™ 5.1

IMPROVED DESIGN RAISES QUALITY LEVEL OF FOOD PRESENTATION

- Pop-in, pop-out thermoset blade is easy to clean, never needs adjustment, and will never corrode
- NEW serrated blades require up to 50% less force than straight blades while maintaining the food quality
- Easy-to-clean pusher block with NEW cleaning tool included, which stows in pusher block assembly
- Tall base designed to fit containers up to 6" (15.2 cm) high
- Full 5" (12.7 cm) square cutting area fits large fruits and vegetables
- NEW captive fasteners will not get lost in food
- Open dimensions (w x d x h): 10" x 11½" x 20" (25.4 x 29.2 x 50.8 cm)
- Closed dimensions (w x d x h): 10" x 11½" x 18½" (25.4 X 29.2 X 47 cm)



2 TWO YEAR WARRANTY

COMPLETE UNIT #	CUT DESCRIPTION: IN (MM)	T-HANDLE, PUSHER BLOCK, AND BLADE*	REPLACEMENT BLADE ONLY *	CASE LOT
55457	¼ (6.4) dice	55483	55470	1
55458	⅜ (9.5) dice	55484	55471	1
55459	½ (12.7) dice	55485	55472	1
55460	¼ (6.4) slice	55486	55473	1
55461	⅜ (9.5) slice	55487	55474	1
55462	½ (12.7) slice	55488	55475	1
55463	4-section wedge	55489	55476	1
55464	6-section wedge	55490	55477	1
55465	8-section wedge	55491	55478	1
55466	10-section wedge	55492	55479	1
55467	12-section wedge	55493	55480	1
55468	6-section core	55494	55481	1
55469	8-section core	55495	55482	1

*Vollrath warranty policies do not cover blades

Cucumber Slicer

- Slices cucumbers lengthwise and cores at the same time
- Great for salad bars and sushi
- 3x faster than cutting by hand
- Open dimensions (w x d x h): 11⁵/₆₄" x 11³/₃₂" x 24" (30 x 28.2 x 61 cm)
- Closed dimensions (w x d x h): 11⁵/₆₄" x 11³/₃₂" x 22⁵/₆₄" (30 x 28.2 x 57.4 cm)



2 TWO YEAR WARRANTY

ITEM #	DESCRIPTION	CASE LOT
55010	14-section core slicer, complete unit	1
REPLACEMENT BLADES AND ACCESSORIES*		
55025	10-section core with 7/8" (2.2 cm) core and adaptor plate	1
55028	14-section core with 1" (2.5 cm) core and adaptor plate	1

*Vollrath warranty policies do not cover blades

InstaCut™ 3.5

DICE, WEDGE & CORE

- Changes from dice to wedge to core in seconds with pop-in, pop-out thermoset blade assembly
- 3x faster than cutting by hand
- Clean, quick cuts reduce bruising for better food presentation

TABLETOP

- Open dimensions (w x d x h): 9" x 9" x 18" (23 x 23 x 45.7 cm)
- Closed dimensions (w x d x h): 9" x 9" x 17½" (23 x 23 x 43.5 cm)

WALL MOUNT

- Open dimensions (w x d x h): 8" x 14½" x 22¼" (20.3 x 36.8 x 56.5 cm)
- Closed dimensions (w x d x h): 8" x 14½" x 14" (20.3 x 36.8 x 35.6 cm)



2 TWO YEAR WARRANTY

TABLETOP UNIT #	WALL MOUNT UNIT #	T-HANDLE, PUSHER BLOCK, AND BLADE* – TABLETOP	PUSHER BLOCK AND BLADE* – WALL MOUNT	CUT DESCRIPTION: IN (MM)	REPLACEMENT BLADE ONLY *	CASE LOT
15000	15016	15059	15081	¼ (6.4) dice	15062	1
15001	15017	15060	15082	⅜ (9.5) dice	15063	1
15002	15018	15061	15083	½ (12.7) dice	15064	1
—	—	15085	15084	¼ x ½ (6.4 x 12.7) dice	15086	1
15003	15019	15050	15073	4-section wedge	15065	1
15005	15021	15052	15075	6-section wedge	15067	1
15006	15022	15053	15076	8-section wedge	15068	1
15007	15023	15054	15077	10-section wedge	15069	1
15008	15024	15055	15078	12-section wedge	15070	1
15009	—	15087	15079	6-section core	15071	1
15010	15026	15058	15080	8-section core	15072	1
ACCESSORIES						
Base assembly		15100	—	—	—	1
Wall mount bracket		—	15125	—	—	1

*Vollrath warranty policies do not cover blades

Wedgemaster™ II

- Constructed of durable, dishwasher-safe polycarbonate material
- Well-balanced, stable footprint
- Cuts lemons, limes, oranges, and more into 6- or 8-section wedges
- 6- or 8-section blades standard, 4- and 12-section blades sold separately



2 TWO YEAR WARRANTY

COMPLETE UNIT #	DESCRIPTION	OPEN DIMENSIONS (W X D X H): IN (CM)	CLOSED DIMENSIONS (W X D X H): IN (CM)	CASE LOT
700-1	6-section cut Wedgemaster™ II	9¾ x 9 x 16 (24.8 x 23 x 40.6)	9¾ x 9 x 15¼ (24.8 x 23 x 38.7)	1
700-4	8-section cut Wedgemaster™ II	9¾ x 9 x 16 (24.8 x 23 x 40.6)	9¾ x 9 x 15¼ (24.8 x 23 x 38.7)	1
BLADE ASSEMBLY*				
704	4-section cut blade assembly (for use with 8-section wedger)	—	—	1
706	6-section cut blade assembly	—	—	1
708	8-section cut blade assembly	—	—	1
712	12-section cut blade assembly (for use with 12-section wedger)	—	—	1

*Vollrath warranty policies do not cover blades

Wedgemaster™

- Great for fast-production kitchen, buffet, and bar preparation
- Cuts fruits consistently for high-quality food and drink presentations
- Available in 6- or 8-section wedge styles



2 TWO YEAR WARRANTY



808SG

COMPLETE UNIT #	DESCRIPTION	OPEN DIMENSIONS (W X D X H): IN (CM)	CLOSED DIMENSIONS (W X D X H): IN (CM)	CASE LOT
606N	6-section cut Wedgemaster™	9 x 8 x 16 (23 x 20.3 x 40.6)	9 x 8 x 15 $\frac{1}{8}$ (23 x 20.3 x 40.3)	1
808N	8-section cut Wedgemaster™	9 x 8 x 16 (23 x 20.3 x 40.6)	9 x 8 x 15 $\frac{1}{8}$ (23 x 20.3 x 40.3)	1
808SG	8-section cut Wedgemaster™ with safety guard	9 x 8 x 16 (23 x 20.3 x 40.6)	9 x 8 x 15 $\frac{1}{8}$ (23 x 20.3 x 40.3)	1
BLADE ASSEMBLY*				
306	6-section wedge blade	—	—	1
308	8-section wedge blade	—	—	1
336	6-section core blade	—	—	1
338	8-section core blade	—	—	1

*Vollrath warranty policies do not cover Redco® blades

InstaBloom® II

- The perfect cut for high-profit blooming onions
- Lower, sturdy profile takes up less space, provides easy storage
- Ergonomic design for easy leverage
- Spring-loaded handle remains safely in upright position when loading onions



2 TWO YEAR WARRANTY



15604

ITEM #	DESCRIPTION	DIMENSIONS (W X D X H): IN (CM)	REPLACEMENT BLADE ITEM #	CASE LOT
15604	InstaBloom® II	14 x 14 x 19 (30.5 x 68.6 x 40.6)	1560102	1

Onion King®

- Slices whole onions and other firm vegetables in one stroke for fast production
- Cuts exact slice thicknesses every time, raising the quality and consistency of menu items



2 TWO YEAR WARRANTY



509



500N

COMPLETE UNIT #	CUT DESCRIPTION: IN (MM)	OPEN DIMENSIONS (W X D X H): IN (CM)	CLOSED DIMENSIONS (W X D X H): IN (CM)	BLADE ASSEMBLY*	CASE LOT
500N	$\frac{3}{16}$ (4.8) – 13 blades	19 $\frac{1}{4}$ x 13 $\frac{3}{4}$ x 19 $\frac{1}{4}$ (49 x 34.9 x 49)	19 $\frac{1}{4}$ x 13 $\frac{3}{4}$ x 15 $\frac{1}{2}$ (49 x 34.9 x 39.4)	509	1
501N	$\frac{1}{4}$ (6.4) – 11 blades	19 $\frac{1}{4}$ x 13 $\frac{3}{4}$ x 19 $\frac{1}{4}$ (49 x 34.9 x 49)	19 $\frac{1}{4}$ x 13 $\frac{3}{4}$ x 15 $\frac{1}{2}$ (49 x 34.9 x 39.4)	511	1
502N	$\frac{3}{8}$ (9.5) – 7 blades	19 $\frac{1}{4}$ x 13 $\frac{3}{4}$ x 19 $\frac{1}{4}$ (49 x 34.9 x 49)	19 $\frac{1}{4}$ x 13 $\frac{3}{4}$ x 15 $\frac{1}{2}$ (49 x 34.9 x 39.4)	510	1
503N	$\frac{1}{2}$ (12.7) – 6 blades	19 $\frac{1}{4}$ x 13 $\frac{3}{4}$ x 19 $\frac{1}{4}$ (49 x 34.9 x 49)	19 $\frac{1}{4}$ x 13 $\frac{3}{4}$ x 15 $\frac{1}{2}$ (49 x 34.9 x 39.4)	512	1

*Vollrath warranty policies do not cover blades

Lettuce King® I

- Consistently shreds lettuce for high-volume applications
- Eliminates 75% of the time and cost of shredding lettuce with a knife
- Easily cuts 1/4 head of lettuce at a time
- Works great on boneless cooked chicken

Slices a variety of foods including cantaloupe, cucumbers, chicken, and more.



2 TWO YEAR WARRANTY

ITEM #	CUT DESCRIPTION: IN (MM)	OPEN DIMENSIONS (W X D X H): IN (CM)	CLOSED DIMENSIONS (W X D X H): IN (CM)	REPLACEMENT BLADE ITEM #*	CASE LOT
400N	3/8 (4.8) cut, 37 blades	17 1/2 x 19 x 26 1/4 (44.5 x 48.3 x 66.7)	17 1/2 x 23 3/4 x 13 3/8 (44.5 x 59.1 x 34)	435	1
403N	1/4 (6.4) cut, 28 blades	17 1/2 x 19 x 26 1/4 (44.5 x 48.3 x 66.7)	17 1/2 x 23 3/4 x 13 3/8 (44.5 x 59.1 x 34)	485	1
402NC	3/8 (9.5) cut, 19 blades	17 1/2 x 19 x 26 1/4 (44.5 x 48.3 x 66.7)	17 1/2 x 23 3/4 x 13 3/8 (44.5 x 59.1 x 34)	484C	1
401N	3/4 (19) cut, 10 blades	17 1/2 x 19 x 26 1/4 (44.5 x 48.3 x 66.7)	17 1/2 x 23 3/4 x 13 3/8 (44.5 x 59.1 x 34)	434	1

*Vollrath warranty policies do not cover blades

Lettuce King® IV & Drum Ring

- Prepares lettuce in a fraction of the time of cutting with a knife
- Drum Ring fits snugly over Rubbermaid® 20- and 32-gallon Greenskeeper™ storage drums

4400N Lettuce King® IV on 2900 Drum Ring — items sold separately



See the Manual Food Processor style guide at VOLLRATH.com for help deciding which processor is best for the food items you're preparing.



2 TWO YEAR WARRANTY



ITEM #	DESCRIPTION	OPEN DIMENSIONS (W X D X H): IN (CM)	CLOSED DIMENSIONS (W X D X H): IN (CM)	REPLACEMENT BLADE ITEM #*	CASE LOT
4400N	Lettuce King® IV, 1" x 1" (25.4 x 25.4 mm) cut	17 x 17 1/2 x 32 (43.2 x 44.5 x 81.28)	17 x 18 1/2 x 21 1/8 (44.5 x 47 x 54.9)	4408	1
2900	Drum Ring	22 3/4 dia. x 1 1/8 (57.8 dia. x 4.8)	—	—	1

*Vollrath warranty policies do not cover blades

Fruit Slicer

- Provides consistent cut for attractive presentation
- Full 5" cutting area optimal for large fruits
- Eliminates 75% of the time and cost of cutting fruit with a knife



2 TWO YEAR WARRANTY

ITEM #	CUT DESCRIPTION: IN (MM)	OPEN DIMENSIONS (W X D X H): IN (CM)	CLOSED DIMENSIONS (W X D X H): IN (CM)	REPLACEMENT BLADE ITEM #*	CASE LOT
403NH	1/4 (6.4) cut, 28 blades	12 57/64 x 13 15/64 x 21 15/16 (32.7 x 33.6 x 55.8)	12 57/64 x 19 15/16 x 9 3/16 (32.7 x 50.7 x 23.3)	485	1

*Vollrath warranty policies do not cover blades

King Kutter™

- Shred, string, krinkle-cut, julienne, grate, and slice a wide variety of foods – may be the most versatile processor in the kitchen
- Easy manual operation with none of the maintenance, electrical issues, or cost associated with powered units
- All cones feature a finely machined, precision stainless steel edge easily changed for fast-cycle processing of foods
- Overall operating dimensions (w x d x h): 8¼" x 9" x 12"

2 TWO YEAR WARRANTY



COMPLETE UNIT #	DESCRIPTION	INCLUDED CONES	CASE LOT
6003	King Kutter™ with suction cup base	#1, 2 & 4	1
6005	King Kutter™ with suction cup base	#1-5	1
6004	King Kutter™ with clamp base	#1, 2 & 4	1
6006	King Kutter™ with clamp base	#1-5	1

*Vollrath warranty policies do not cover blades

REPLACEMENT CONE ITEM #*	REPLACEMENT CONE DESCRIPTION	CASE LOT
6011	#1 – ⅛" (3.2 mm) shredder cut	1
6012	#2 – ⅜" (4.8 mm) string cut	1
6013	#3 – ⅜" (9.5 mm) petite french fry cut	1
6014	#4 – ⅛" (3.2 mm) thin-slice cut	1
6015	#5 – ⅜" (4.8 mm) krinkle cut	1
6016	#6 – ⅜" (4.8 mm) thick-slice cut	1

CubeKing™

- Cut cheese cubes, sticks, square blocks, and rectangular blocks, fast and uniformly
- Open dimensions (w x d x h): 17" x 17¼" x 32" (43.2 x 43.8 x 81.3 cm)
- Closed dimensions (w x d x h): 17" x 18½" x 21⅝" (43.2 x 47 x 54.9 cm)

NSF **2** TWO YEAR WARRANTY



ITEM #	DESCRIPTION, IN (MM)	CASE LOT
1811	CubeKing™ ¾ (19.1 mm) cut	1
1812	CubeKing™ ⅝ (9.5 mm) cut	1
1823	CubeKing™ replacement wire kit	1

Cheese Blocker™

- Accommodates blocks up to 50 lbs and wheels up to 35 lbs
- ½" (12.7 mm) measuring increments on front plate and base
- Prepare cheese for cubing, slicing, and shredding
- Handle-up dimensions (w x d x h): 12¼" x 29¼" x 22⅝" (31.1 x 74.3 x 57.5 cm)
- Handle-down dimensions (w x d x h): 12¼" x 22" x 12¼" (31.1 x 55.8 x 31.1)

NSF **2** TWO YEAR WARRANTY



COMPLETE UNIT #	DESCRIPTION	REPLACEMENT WIRE KIT	CASE LOT
1837	Cheese Blocker™	1838	1

Potato Cutters

- Heavy, strong, nickel-plated ductile cast iron frame and sure-grip handle
- Clean and durable stainless steel "V" trough guarantees smooth operation
- Dimensions: 11½" (29.2 cm) deep at base, 14" (35.6 cm) high with closed handle, 34½" (87.6 cm) deep x 23" (58.4 cm) high with open handle
- Screw holes on base of legs for permanent mounting to table or wall



2 TWO YEAR WARRANTY

ITEM #	DESCRIPTION	REPLACEMENT BLADE ITEM #	CASE LOT
47703*	Wedge cut, 8-cut	45603-1	1
47715**	French fry, ½" (0.7 cm) cut size	45751-1	1
47713**	French fry, ¾" (1 cm) cut size	45749-1	1
47714**	French fry, ⅞" (1.1 cm) cut size	45750-1	1
45682***	Potato cutter wall hanger bracket	—	1

*Replacement blades and parts available **Replacement blades available ***Screws not included

E-Z Juice Extractor

- Superior leverage for maximum juice output
- Heavy-duty, enamel-coated cast iron base and stainless steel body
- Rubber feet ensure no-slide use

2 TWO YEAR WARRANTY



ITEM #	DESCRIPTION	OVERALL HEIGHT: IN (CM)	MINIMAL TABLETOP SPACE REQUIRED (W X D): IN (CM)	CASE LOT
47704	Juice extractor	26 (66) with handle in upright position	8 x 9 (20.3 x 22.9)	1

InstaSlice™

- Pop-in, pop-out thermoset blade is easy to clean, never needs adjustment, and will never corrode
- Large slicing area
- Corrosion-resistant polyurethane food carrier
- HardCoat® pusher head fingers resist corrosion from tomato acids and other harsh foods
- Detachable table stop ensures processor will stay in place
- Available with straight or scalloped blades, allowing slicing of tomatoes without "pre-scoring" the skin

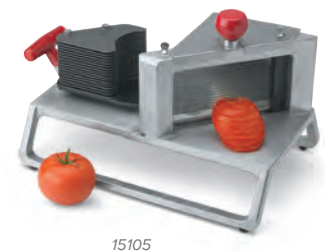

NSF **2** TWO YEAR WARRANTY

COMPLETE UNIT #	CUT SIZE IN (MM)	BLADE TYPE	NO. OF BLADES	OPEN DIMENSIONS (W X D X H): IN (CM)	CLOSED DIMENSIONS (W X D X H): IN (CM)	REPLACEMENT BLADE ITEM #*	CASE LOT
15105	⅜ (4.8)	Scalloped	16	10½ x 17½ x 10¾ (26.7 x 44.5 x 27.3)	10½ x 16 x 10¾ (26.7 x 40.6 x 27.3)	15115	1
15205	⅜ (4.8)	Straight	16	10½ x 17½ x 10¾ (26.7 x 44.5 x 27.3)	10½ x 16 x 10¾ (26.7 x 40.6 x 27.3)	15209	1
15102	⅞ (5.6)	Scalloped	13	10½ x 17½ x 10¾ (26.7 x 44.5 x 27.3)	10½ x 16 x 10¾ (26.7 x 40.6 x 27.3)	15112	1
15202	⅞ (5.6)	Straight	13	10½ x 17½ x 10¾ (26.7 x 44.5 x 27.3)	10½ x 16 x 10¾ (26.7 x 40.6 x 27.3)	15206	1
15103	¼ (6.4)	Scalloped	12	10½ x 17½ x 10¾ (26.7 x 44.5 x 27.3)	10½ x 16 x 10¾ (26.7 x 40.6 x 27.3)	15113	1
15203	¼ (6.4)	Straight	12	10½ x 17½ x 10¾ (26.7 x 44.5 x 27.3)	10½ x 16 x 10¾ (26.7 x 40.6 x 27.3)	15207	1
15104	⅜ (9.5)	Scalloped	8	10½ x 17½ x 10¾ (26.7 x 44.5 x 27.3)	10½ x 16 x 10¾ (26.7 x 40.6 x 27.3)	15114	1
15204	⅜ (9.5)	Straight	8	10½ x 17½ x 10¾ (26.7 x 44.5 x 27.3)	10½ x 16 x 10¾ (26.7 x 40.6 x 27.3)	15208	1

*Vollrath warranty policies do not cover blades

Tomato Pro™

- NSF®-approved, high-density polyethylene base material is designed for constant contact with tomato acids and other harsh foods – will not corrode
- Positive-stop arm helps keep slicer sturdy while operating the push-through slicing mechanism
- Open and closed dimensions (w x d x h): 9½" x 18¾" x 9½" (24.1 x 47.6 x 24.1 cm)



2 TWO YEAR WARRANTY

COMPLETE UNIT #	DESCRIPTION	CUT IN (MM)	BLADE STYLE	CASE LOT	REPLACEMENT BLADE ITEM #*	CUT IN (MM)	BLADE STYLE	NO. OF BLADES	CASE LOT
0643N	Tomato Pro™, without safety guard	⅜ (4.8)	Straight	1	0653	⅜ (4.8)	Straight	15	1
0644N	Tomato Pro™, without safety guard	¼ (6.4)	Straight	1	0654	¼ (6.4)	Straight	11	1
0646N	Tomato Pro™, without safety guard	⅜ (9.5)	Straight	1	0656	⅜ (9.5)	Straight	8	1
0694N	Tomato Pro™, without safety guard	⅜ (4.8)	Scalloped	1	0648	⅜ (4.8)	Scalloped	15	1
0645N	Tomato Pro™, without safety guard	¼ (6.4)	Scalloped	1	0652	¼ (6.4)	Scalloped	11	1
0643SGN	Tomato Pro™, with safety guard	⅜ (4.8)	Straight	1	0653	⅜ (4.8)	Straight	15	1
0644SGN	Tomato Pro™, with safety guard	¼ (6.4)	Straight	1	0654	¼ (6.4)	Straight	11	1
—	—	—	—	—	0647	⅜ (9.5)	Scalloped	8	1

*Vollrath warranty policies do not cover blades

Tomato King® Scooper

- One quick twist removes tomato cores, making them ready for slicing – a must-have for high-production food prep
- Also can be used to remove potato eyes, core strawberries, score cucumbers, and make melon balls



ITEM #	DESCRIPTION	CASE LOT
1400	Tomato King® Scooper – bulk pack	144
1401	Tomato King® Scooper – standard pack	24

Tater King® Scooper

- Scoop, skin, and wedge four partially baked potatoes in less than a minute
- Quickly prepare deep-fried skins, steak fries, twice-baked potatoes, and more



COMPLETE UNIT #	DESCRIPTION	CASE LOT	REPLACEMENT BLADE ITEM #	REPLACEMENT HANDLE WITH GRIP ITEM #	REPLACEMENT CASE LOT
1801	Tater King™ Scooper	12	1802	1803	1

Lobster King™



- Makes lobster tails ready for preparation in one clean cut of the shell
- Also works on crab legs
- Handle-up dimensions (w x d x h): 10" x 15¼" x 16" (25.4 x 38.7 x 40.6 cm)
- Handle-down dimensions (w x d x h): 10" x 19½" x 4¼" (25.4 x 49.5 x 10.8 cm)



COMPLETE UNIT #	DESCRIPTION	REPLACEMENT KNIFE ITEM #: 10" (25.4 CM)*	CASE LOT
1851	Lobster King™	5103	1

*Vollrath warranty policies do not cover blades

Oyster King™



- Opens oysters and clams with one simple, safe stroke
- Durable steel point blade
- Handle-up dimensions (w x d x h): 5⅞" x 10½" x 15" (14.9 x 26.7 x 38.1 cm)
- Handle-down dimensions (w x d x h): 5⅞" x 14¾" x 4¼" (14.9 x 37.5 x 10.8 cm)



COMPLETE UNIT #	DESCRIPTION	REPLACEMENT BLADE ITEM #	CASE LOT
1853	Oyster King™	5382	1

Grill Tender®

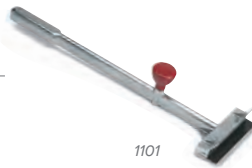

- Removes carbonized food from grill surfaces quickly and easily
- Splash guard and extra-long handle offer added protection from burns and kickback of debris
- Durable steel point blade



COMPLETE UNIT #	DESCRIPTION	DIMENSIONS (W X D X H): IN (CM)	REPLACEMENT BLADE ITEM #	CASE LOT
1101	Grill Tender®	21½ x 6 x 3⅞ (54.9 x 15.2 x 7.9)	1102R*	1

*Vollrath warranty policies do not cover blades

Petro-Gel®

- Designed specifically to lubricate all manual food processors
- Tasteless and odorless
- A food-safe lubricant



ITEM #	DESCRIPTION	CASE LOT
15149	4 oz petrol sanitary gel lubricant	1

GRINDERS

Grinders

- Sausage stuffer and feed stick accessories included
- Stainless steel body, cylinder, worm gear, and ring
- Supplied with ⅛" (3.2 mm) and ⅝" (7.9 mm) grinder plates
- Dishwasher-safe grinding head, pan, and attachment
- Heavy-gauge product tray with 2¼" (5.7 cm) diameter food chute



No. 22, 40744 with standard accessories



Visit VOLLRATH.com/grinder for grinder accessories, images, and other resources.

ITEM #	MODEL	DESCRIPTION	DIMENSIONS (W X D X H): IN (CM)	OUTPUT	HP	VOLTAGE	AMPS	PLUG
40743	MIN0012	Meat grinder No. 12	10⅜ x 15¾ x 19⅞ (25.9 x 40 x 49.4)	264 lb (120 Kg)/hr	1	110 AC	8	5-15P
40744	MIN0022	Meat grinder No. 22	10⅜ x 20¼ x 24¼ (27.5 x 51.4 x 61.6)	528 lb (240 Kg)/hr	1½	110 AC	16	5-20P

CAN OPENERS

THE CLEANEST, MOST HYGIENIC CUT EVER

- Patented quick-release blade carrier for easy cleaning
- EaziClean® blades are finished with anti-bacterial coating for increased safety
- High-grade steel cutting mechanism for clean cut – no risk of frayed metal shavings
- Case-hardened blade for longer life
- Wheels made from gear-cutting-grade steel – able to withstand intense pressure
- Ergonomic design for more comfortable use



Color-coded collars
for easy identification



2 TWO YEAR WARRANTY

EaziClean® Can Openers

ITEM #	DESCRIPTION	BAR LENGTH IN (CM)	MAX CAN HEIGHT IN (CM)	GEAR IN (CM)	OUTPUT PER DAY (#10 CAN)	CASE LOT	BLADE ITEM #	GEAR ITEM #	CARTRIDGE ITEM #
BCO-2000	Medium-duty, ZAMAC alloy construction, yellow collar	16 (40.6)	14 (35.6)	1 (2.5)	20 cans	1	BCO-11	BCO-12	BCO-15
BCO-3000	Medium-duty, ZAMAC alloy construction, yellow collar	25 (63.5)	22 (55.9)	1 (2.5)	20 cans	1	BCO-11	BCO-12	BCO-15
BCO-5000	Heavy-duty, stainless steel construction, blue collar	16 (40.6)	14 (35.6)	1½ (3.8)	60 cans	1	BCO-11	BCO-10	BCO-14
BCO-6000	Heavy-duty, stainless steel construction, blue collar	25 (63.5)	22 (55.9)	1½ (3.8)	60 cans	1	BCO-11	BCO-10	BCO-14
BCO-7000	Titan, stainless steel construction, dishwasher safe, black collar	25 (63.5)	22 (55.9)	1½ (3.8)	60+ cans	1	BCO-11	BCO-10	BCO-14

Premium™ and CanMaster™ Can Openers

ITEM #	DESCRIPTION	BAR LENGTH IN (CM)	MAX CAN HEIGHT IN (CM)	GEAR IN (CM)	CASE LOT	BLADE ITEM #	GEAR ITEM #
BCO-1*	Premium™ Can Opener	16 (40.6)	14 (35.6)	1 (2.5)	1	BCO-11	BCO-12
BCO-4*	CanMaster™ Can Opener	16 (40.6)	14 (35.6)	1½ (3.8)	1	BCO-11	BCO-10

*Items BCO-1 and BCO-4 are not NSF® certified

MIXERS

DURABILITY, RELIABILITY, AND REPUTATION
ALL IN ONE TOUGH RANGE OF MIXERS

FLOOR/BENCH MIXERS

- Safety cutoff switch temporarily interrupts power if gears are changed without stopping the mixer
- Three-speed transmission, belt-driven
- 60-qt. model includes bowl truck for convenient bowl transport

COUNTERTOP MIXERS

- Commercial-grade table model with a powerful 1/3 hp motor
- Five-speed, 100% direct gear driven
- Digital control panel to make easy speed shifts while unit is running
- Non-skid rubber base
- 30-minute timer



Visit VOLLRATH.com/mixer for capacity information, images, and other resources.



ITEM #	MODEL	DESCRIPTION	DIMENSIONS (W X D X H): IN (CM)	TRANSMISSION	HP	VOLTAGE	AMPS	PLUG
FLOOR/BENCH MIXERS								
40757	MIX1020	20 qt mixer with guard	20 ³ / ₈ x 20 ³ / ₈ x 35 ⁵ / ₈ (51.8 x 51.8 x 90.5)	3-speed	1/2	110 AC	8	5-15P
40758	MIX1030	30 qt mixer with guard	25 x 24 ¹ / ₂ x 47 ¹ / ₈ (63.5 x 62.2 x 121.6)	3-speed	1	110 AC	20	5-20P
40759	MIX1040	40 qt mixer with guard	26 ¹ / ₂ x 26 ³ / ₈ x 47 ¹ / ₈ (67.3 x 67.5 x 119.7)	3-speed	1 ¹ / ₂	220 AC	12	6-15P
40760	MIX1060	60 qt mixer with guard	27 ³ / ₈ x 30 x 55 ¹ / ₈ (69.5 x 76.2 x 141.8)	3-speed	2	220 AC	16	6-20P
COUNTERTOP MIXERS								
40755	MIX1007	7 qt mixer with guard	13 ¹ / ₈ x 17 ³ / ₄ x 20 ¹ / ₄ (33.3 x 45.1 x 51.4)	5-speed	1/3	110 AC	6	5-15P
40756	MIX1010	10 qt mixer with guard	13 ¹ / ₈ x 17 ³ / ₈ x 21 ¹ / ₈ (33.2 x 44.9 x 53.8)	5-speed	1/3	110 AC	6	5-15P



For international models with 220-240V, add "02" for Schuko, "03" for UK, or "05" for Australian to end of item number (e.g., Australian 40757 to 4075705). Product details vary (e.g., voltage, amps, watts); visit VOLLRATH.com.

MIXER ACCESSORIES

ITEM #	DESCRIPTION	FITS
40785	Vegetable slicer head complete, comes with 3/8" (8 mm) shredder and 3/16" (5 mm) slicing plates	All Vollrath floor & bench mixers
40786	Meat grinder head attachment for No. 12 hub with 1/8" (3 mm) and 3/16" (8 mm) grinder plates	All Vollrath floor & bench mixers
40787	Reducer kit – includes 20 qt stainless steel bowl, whisk, dough hook, and beater	40 qt mixer
40781	Reducer kit – includes 30 qt stainless steel bowl, whisk, dough hook, and beater	60 qt mixer
MSG2003	3/8" (3 mm) slicing plate	40785 vegetable slicer head
MSG3002	3/64" (2 mm) shredding plate	40785 vegetable slicer head
MSG3005	3/16" (5 mm) shredding plate	40785 vegetable slicer head

Note: Do not use attachments on hub while mixing.

DESCRIPTION	7 QUART ITEM #	10 QUART ITEM #	20 QUART ITEM #	30 QUART ITEM #	40 QUART ITEM #	60 QUART ITEM #
Wire whisk	XMIX0705	40762	40766	40770	40774	40778
Dough hook	XMIX0704	40763	40767	40771	40775	40779
Flat beater	XMIX0703	40764	40768	40772	40776	40780
Mixing bowl	XMIX0702	40761	40765	40769	40773	40777



No. 12 hub accommodates meat grinder and vegetable slicer attachments for flexibility with grinding, slicing, and mixing

Gears and shafts are made of heat-treated alloy steel for long life and quieter operation

Grease-packed ball bearing

Bowl arm protection cover

Heavy-duty construction

Surface protection foot covers

Thermal overload protection automatically shuts off mixer to protect from damage

30-minute digital timer with automatic stop and audible shutoff signal

Consistent mixing speeds

Bowl lock

Planetary mixing action

Learn how to calculate your absorption ratio and get other tips at VOLLRATH.com/mixer.

40757

ALL MIXERS COME STANDARD WITH:



Stainless Steel Mixing Bowl
(60 qt mixer includes bowl truck)



Dough Hook



Wire Whisk



Flat Beater

GRINDER AND SLICER ATTACHMENTS

(Sold separately)



Meat Grinder 40786



Vegetable Slicer 40785



“With 210 different students working with our mixers, it is a must they can withstand the abuse. Vollrath mixers provide the quality and value we demand.”

MICHAEL PIERINI
Chef Instructor, Culinary Program Director
Cerritos College



SLICERS

100% ITALIAN DESIGNED AND ENGINEERED FOR OPTIMUM RESULTS



Safety hand guard mounted to carriage

Hard-coated anodized aluminum body

High-quality and belt-driven

Non-marking, non-skid rubber feet

Slice adjustment knob for precision and consistency

Safety cover under motor



Proprietary nonstick coating reduces drag and makes your slicer easier to clean



25° or 35° gravity feed maximizes productivity by reducing operator fatigue and discomfort



Built-in sharpener



Certified to NSF/ANSI 8

5 YEAR WARRANTY ON BELT



Quantanium, a unique mix of titanium blended into the plate coating, causes it to be harder and more durable than conventional reinforced systems.



ITEM #	40950	40951	40952	40954	40955
RATING	Medium	Medium	Heavy	Heavy	Max
PROCESSED MEATS	x 3hr/day	x 3hr/day	x continuous	x continuous	x continuous
CHEESE	–	–	x continuous	x continuous	x continuous
BLADE	10"	12"	12"	12"	13"
SLICE THICKNESS	Up to ½"	Up to ½"	Up to 1"	Up to 1"	Up to 1"
25° GRAVITY FEED	✓	✓	–	–	–
35° GRAVITY FEED	–	–	✓	✓	✓
NON-STICK COATING	✓	✓	✓	✓	✓
SAFE BLADE REMOVAL SYSTEM	–	–	✓	✓	✓
PERMANENT BLADE RIM GUARD	–	✓	✓	✓	✓
REMOVABLE CARRIAGE	✓	✓	✓	✓	–
EXTRA-LONG SLIDE ROD	–	–	–	–	✓
TILTING	–	–	–	–	✓
KICKSTAND	–	–	–	✓	✓
HORSEPOWER MOTOR	⅓ peak HP	⅔ peak HP	½ peak HP	¾ peak HP	½ peak HP

ITEM #	MODEL #	DESCRIPTION	DIMENSIONS (W X D X H): IN (CM)	DRIVE	HP	VOLTAGE	AMPS	PLUG
SLICERS								
40950	SLM250/S	10" (25.4 cm) medium-duty slicer	22½" x 22¾" x 18½" (56 x 57 x 47.5)	Belt	⅓	120 AC	2.5	5-15P
40951	SLM300P/S	12" (30.5 cm) medium-duty slicer	24 x 25¾" x 20½" (61 x 64 x 51)	Belt	⅔	120 AC	1.8	5-15P
40952	SLP300/S	12" (30.5 cm) heavy-duty slicer	22¾" x 27½" x 22¾" (54.7 x 71 x 54.7)	Belt	½	120 AC	2	5-15P
40954	SLP300EA/S	12" (30.5 cm) heavy-duty slicer, automatic	22¾" x 29¾" x 24¾" (57.5 x 75.2 x 63.2)	Belt	¾	120 AC	4	5-15P
40955	SLP330E/S	13" (33.0 cm) deluxe deli-style slicer	25¾" x 28¾" x 24¾" (64 x 73 x 61.6)	Belt	½	120 AC	2	5-15P

ITEM #	DESCRIPTION	WORKS WITH
ACCESSORIES		
40895	7" vegetable chute	40952 HD12" and 40955 Deli-style 13"
40896	12" serrated blade – includes a safe blade removal tool	40952
40897	13" serrated blade – includes a safe blade removal tool	40955
40898	10" safe blade removal tool	40950
40893	12" safe blade removal tool	40951 and 40952
40894	13" safe blade removal tool	40955
40899	Carriage handle for Quebec	40950, 40951, and 40952

40950 – 10" BLADE MEDIUM-DUTY SLICER

- Space-saving design with small footprint
- Easy to carry for catering needs
- Medium-volume – ideal for small restaurants
- Slice adjustment knob for precise and consistent slice thickness up to ½"
- Removable carriage for easy cleaning

40951 – 12" BLADE MEDIUM-DUTY SLICER

- Great cutting capacity within a compact footprint
- Medium-volume – ideal for small restaurants
- Slice adjustment knob for precise and consistent slice thickness up to ½"
- Permanent blade rim guard
- Removable carriage for easy cleaning

40952 – 12" BLADE HEAVY-DUTY SLICER

- Ideal for higher-volume operations such as large restaurants
- Large receiving tray
- Safe blade removal tool
- Solid aluminum slice adjustment knob for precise and consistent slice thickness up to 1"
- Permanent blade rim guard
- Removable carriage for easy cleaning

40955 DELUXE – 13" BLADE DELI-STYLE SLICER

- Ideal for high-volume operations such as large restaurants or delis/supermarkets
- Large receiving tray
- Extra-long slide rod to accommodate large loaves of meats and cheeses
- Safe blade removal system
- Solid aluminum slice adjustment knob for precise and consistent slice thickness up to 1"
- Permanent blade rim guard
- Carriage tilts open with zero blade exposure for safety and easy cleaning
- Kickstand to easily and safely clean under the slicer

VACUUM PACKING

VACUUM PACKING CUTS DOWN ON FOOD SPOILAGE BY EXTENDING THE REFRIGERATED SHELF LIFE OF FOODS BY THREE TO FIVE TIMES!

OUT-OF-CHAMBER

- Out-of-chamber vacuum packing requires specific bag type (listed below)
- Not suited for use with liquids

IN-CHAMBER

- Suitable with wet or dry products
- Stainless steel chamber
- Easy removal of chamber components for thorough cleaning



40858



40833



40834



40831

Vacuum Pack Machines

- Extends the shelf life of foods and cuts down on waste due to spoilage
- Excellent for items like meats and cheese
- Vacuum packing opens the pores in foods, creating an excellent way to quickly marinate meats



ITEM #	MODEL	DIMENSIONS (W X D X H): IN (CM)	CHAMBER SIZE (W X D X H): IN (CM)	SEALING BAR LENGTH: IN (CM)	VOLTAGE	WATTS	AMPS	PLUG
OUT-OF-CHAMBER VACUUM PACK MACHINE								
40858	Junior	14¾ x 11⅞ x 5⅞ (37.5 x 29.7 x 14.5)	—	12¾ (31)	120 AC	380	3.3	5-15P
IN-CHAMBER VACUUM PACK MACHINES								
40831	VP12	17" x 21⅜" x 14" (44.9 x 55.4 x 36.5)	14½ x 17 x 4 (36.8 x 43.2 x 10.2)	12" (30.5)	120 AC	500	8.5	5-15P
40833	VP16	19¾ x 20⅜ x 15⅞ (49.2 x 52.9 x 38.9)	16⅜ x 16½ x 5 (42.7 x 41.9 x 12.7)	16" (40.6)	120 AC	900	13	5-20P
40834	VPP16	19¾ x 20¾ x 18 (49.2 x 51.8 x 45.7)	16⅜ x 16½ x 5 (42.7 x 41.9 x 12.7)	16" (40.6)	120 AC	900	13	5-20P

ITEM #	SEAL BAR	NUMBER OF SEALING BARS	VACUUM BY TIME	VACUUM BY DESIRED PRESSURE	LIQUID SENSOR CONTROL	ADJUSTABLE SOFT-AIR SETTING	MAINTENANCE REMINDER	ADVANCED CONTROL SYSTEM	CUSTOMIZABLE PROGRAMS	PASSWORD-CONTROLLED ACCESS	USB CONNECTION FOR LABEL PRINTER	LABEL PRINTING	HACCP LOGGING	MARINATE FUNCTION
40831	12"	1	✓	—	—	—	✓	—	—	—	—	—	—	—
40833	Two 16"	2	✓	✓	✓	✓	✓	—	10	—	—	—	—	—
40834	Two 16"	2	—	✓	✓	✓	✓	✓	20	✓	✓	✓	✓	✓

Vacuum Pack Bags

ITEM #	DESCRIPTION	DIMENSIONS: IN (CM)	TOTAL THICKNESS	MAX TEMP	CASE LOT
40812	Out-of-chamber	6 x 12 (15.2 x 30.5)	3.9 mil	158°F (70°C)	100
40813	Out-of-chamber	8 x 12 (20.3 x 30.5)	3.9 mil	158°F (70°C)	100
40814	Out-of-chamber	10 x 14 (25.4 x 35.6)	3.9 mil	158°F (70°C)	100
40815	In-chamber – regular	8 x 12 (20.3 x 30.5)	3.0 mil	158°F (70°C)	100
40816	In-chamber – regular	10 x 15 (25.4 x 38.1)	3.0 mil	158°F (70°C)	100
40817	In-chamber – regular	12 x 16 (30.5 x 40.6)	3.0 mil	158°F (70°C)	100
40818	In-chamber – regular	14 x 20 (35.5 x 45.7)	3.0 mil	158°F (70°C)	100
23850	In-chamber – “boil-in”	6 x 8 (15.2 x 20.3)	4.0 mil	212°F (100°C)	100
23852	In-chamber – “boil-in”	8 x 12 (20.3 x 30.4)	4.0 mil	212°F (100°C)	100
23854	In-chamber – “boil-in”*	12 x 16 (30.5 x 40.6)	4.0 mil	212°F (100°C)	100

PAIR IT WITH A SOUS VIDE IMMERSION CIRCULATOR

- Precise, repeatable results with no moisture loss
- Occupies minimal counter space
- See page 49





COOKING EQUIPMENT

From induction and sous vide immersion circulators to griddles and fryers to our complete collection of conveyor toasters and ovens, Vollrath has every countertop cooking appliance you need to make your kitchen more efficient and innovative.

How to Shop COOKING EQUIPMENT

Induction Ranges



With an all-new, sleek efficient design and induction technology, our full line of induction products are safer, more precise, faster, and more efficient than traditional gas ranges.

Pages 29-33

NEW

Conveyor Toasters



Vollrath conveyor toasters feature industry-leading design technology and are made in the USA. Forced convection and energy-efficient quartz hearts provide consistent toasting of bread products.

Pages 34, 35-37

Charbroilers & Griddles



Our rugged, versatile line of heavy-duty charbroilers and griddles is designed to get the cooking and the cleanup done quickly.

Pages 45-46

Sandwich Presses



Expand your menu easily with panini and flat-plate sandwich presses. Each model features a heavy-duty design and is thermostatically controlled for consistent results.

Page 47

SERVING SYSTEMS AND COMPONENTS

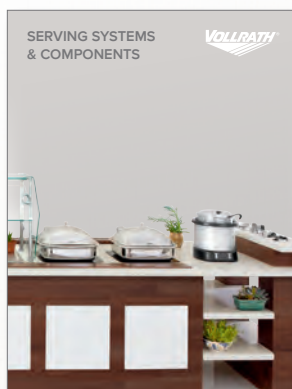

DROP-IN INDUCTION RANGES

With options for light use/warming as well as heavy-duty use, our drop-in induction ranges offer precise dial control. Their streamlined appearance can enhance your serving equipment's look while adding convenient functionality.

Reference our Serving Systems & components catalog or VOLLRATH.com/inductionrangedi for our full line of drop-in induction ranges.

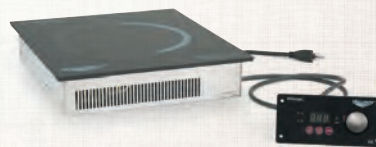

NEW

Conveyor Ovens



Whether for pizzas, sandwiches, or melting cheese, Vollrath has a high-quality American-made oven designed to meet the ever-changing demands of the kitchen. Variable speed control and forced convection technology make Vollrath conveyor ovens the best choice for uniform results and superior efficiency.

Pages 34, 39-40

NEW

Ranges & Specialty Ovens



Our full line of ranges, including induction options, gives you the flexibility and performance you need. Our convection and microwave ovens are designed to stand up to even the busiest kitchen.

Pages 42-44

Fryers



Designed for quick heat-up and recovery, our fryers help you keep up with even the busiest rush on fries, breaded fish, and more.

Page 48

Sous Vide Immersion Circulators



Get precise, repeatable results with Vollrath's sous vide immersion circulators. Cooking with precise temperature control allows you to create tender, juicy meats.

Page 49



INDUCTION RANGES



Visit VOLLRATH.com for induction videos and articles.



**CAYENNE® HD
INDUCTION
RANGE**



**ULTRA
SERIES**



**PROFESSIONAL
SERIES**



**MIRAGE®
PRO**



**MIRAGE
CADET**



**INDUCTION
WOK RANGE**

OUTPUT					
11,600 Maximum Wattage	3,500 Maximum Wattage	2,900 Maximum Wattage	1,800 Maximum Wattage	1,800 Maximum Wattage	3,500 Maximum Wattage
IDEAL FOR					
Ideal for heavy-duty and supplemental back-of-the-house range cooking, flameless cooking leads to safer working conditions and cooler kitchens. Excellent for menu items that require more accurate temperature control.	Perfect for high-volume, high-speed, and continuous-duty stockpot stations.	Great for medium volumes and speed, high-speed sautéing, and small stockpot and saucepot warming.	A smart choice for light commercial, sauté, and non-continuous small stockpot warming. Preferred by chefs for a variety of cooking techniques.	Suitable for light commercial, sauté, and non-continuous small stockpot warming.	Ideal for preparing menu items with gas-like performance but the high efficiency of induction in a safe, flameless, easy-to-use electrical application for commercial use.
APPROX. TOP HEATING TEMPERATURE					
550°F	550°F	525°F	400°F	400°F	850°F
EFFICIENCY					
90%	90%	90%	90%	75%	90%
POWER RANGE SETTINGS					
Rotary, 1 to 100	1 to 100	1 to 100	1 to 100	1 to 20	1 to 100, turbo
WARRANTY					
1 year	2 years	2 years	2 years	1 year	1 year
CHOSEN BY					
<ul style="list-style-type: none"> Restaurants – fine and casual dining Hospitality Colleges/ universities Culinary schools 	<ul style="list-style-type: none"> High-volume hotels Large-volume restaurants Cruise ships Military Culinary schools Top chefs who demand extreme high and low temp control 	<ul style="list-style-type: none"> Casual dining restaurants Quick-serve restaurants Hospitality (front or back of the house) Cruise ships Culinary schools Businesses and institutions 	<ul style="list-style-type: none"> Hotels Caterers Casual dining restaurants Quick-serve restaurants Sub shops and delis Stadium/arena luxury suites Businesses and institutions Pastry chefs 	<ul style="list-style-type: none"> Hotels Caterers Sub shops and delis 	<ul style="list-style-type: none"> Casual dining restaurants Colleges/ universities Culinary schools Hospitality Cruise ships Caterers Hotels

IMPORTANT NOTE: Vollrath will guarantee that Vollrath induction-ready products will work with Vollrath induction ranges and warmers, unless otherwise noted. Vollrath induction ranges and warmers are calibrated to work with a wide range of induction-ready products, but we cannot guarantee the quality and material choices of other manufacturers, or the performance of our ranges when used with those products.

MIRAGE® INDUCTION RANGES



Mirage Pro

- Proprietary high-performance induction technology
- 90% energy efficiency – compare to the approximate 40% efficiency of gas ranges
- 100 power levels for precise cooking control
- 80°-400°F (27°-204°C) temperature setting



Visit VOLLRATH.com/induction for induction videos and articles.



ITEM #	DESCRIPTION	DIMENSIONS (W X D X H): IN (CM)	VOLTAGE	KW	AMPS	PLUG	CASE LOT
59500P	Countertop – US only	14 x 15¼ x 3 (35.6 x 38.7 x 7.6)	120 AC	1.8	15	5-15P	1
59510P	Countertop – US and Canada	14 x 15¼ x 3 (35.6 x 38.7 x 7.6)	120 AC	1.4	12	5-15P	1

Mirage Cadet

- Proprietary induction technology
- 75% efficient – compare to the approximate 40% efficiency of gas ranges
- 20 power levels
- 100°-400°F (38°-204°C) temperature setting



ITEM #	DESCRIPTION	DIMENSIONS (W X D X H): IN (CM)	VOLTAGE	KW	AMPS	PLUG	CASE LOT
59300	Countertop – US only	12 x 16 x 3¾ (30.5 x 40.6 x 7.9)	120 AC	1.8	15	5-15P	1
59310	Countertop – Canada only	12 x 16 x 3¾ (30.5 x 40.6 x 7.9)	120 AC	1.4	12	5-15P	1

Mirage Carrying Case

- Convenient carrying case to transport and protect your countertop induction range
- Side pocket fits cookware or other items



ITEM #	DESCRIPTION	DIMENSIONS (W X D X H): IN (CM)	CASE LOT
59145	Carrying case for Mirage countertop units	16½ x 18½ x 4½ (41.9 x 47 x 11.4)	1

Induction Wok Range

- High efficiency of induction, with gas-like performance
- 100 power settings for precise cooking control
- Turbo button for immediate, fast heat
- Simple digital power level controls



Stainless steel template for drop-in induction wok range



ITEM #	DESCRIPTION	DIMENSIONS (W X D X H): IN (CM)	VOLTAGE	KW	AMPS	CASE LOT
6958301	Countertop induction wok range*	17 x 20 $\frac{1}{8}$ x 8 $\frac{5}{16}$ (43.2 x 51 x 21)	208-240	3-3.5	14.6	1
58814	Carbon steel wok pan	Pan diameter 14 (35.6) x height 3 $\frac{3}{8}$ (9.9)	-	-	-	1
69584	Stainless steel template for drop-in induction wok range	22 x 19 x $\frac{3}{4}$ (55.9 x 48.3 x 1.9)	-	-	-	1

* Ships with carbon steel wok pan

Cayenne® HD Induction Ranges

- 90% energy efficiency compared to 40% for gas means:
 - Instant, controllable heat
 - Lower energy costs, including HVAC
 - A cooler kitchen



Visit VOLLRATH.com/induction for induction videos and articles.



912HIDC



924HIMC



ITEM #	DESCRIPTION	DIMENSIONS (L X H X D): IN (CM)	VOLTAGE	MAX KW/HOB	PLUG	TOTAL AMPS	CASE LOT
912HIMC	12" dual-hob – manual control (US/Canada)	12 x 13 $\frac{5}{8}$ x 30 (30.5 x 34.6 x 76.2)	208/240	2,900	6-30P	24	1
924HIMC*	24" four-hob – manual control (US/Canada)	24 x 13 $\frac{5}{8}$ x 30 (61.0 x 34.6 x 76.2)	208/240	2,900	6-30P	2 x 24	1
912HIDC	12" dual-hob – digital control (US/Canada)	12 x 13 $\frac{5}{8}$ x 30 (30.5 x 34.6 x 76.2)	208/240	2,900	6-30P	24	1
924HIDC*	24" four-hob – digital control (US/Canada)	24 x 13 $\frac{5}{8}$ x 30 (61.0 x 34.6 x 76.2)	208/240	2,900	6-30P	2 x 24	1

* Four-hob provided with two 30-amp plugs. Requires two independent circuits.

Commercial Series Induction Ranges

- Designed for light commercial sauté and warming stations
- Ideal for presentation cooking, omelet stations, or small reheat stations
- Nine control settings
- Easy-to-clean digital display with no knobs to help prevent accidental temperature changes



6950020



ITEM #	DESCRIPTION	DIMENSIONS (W X D X H): IN (CM)	VOLTAGE	MAX KW	AMPS	PLUG	CASE LOT
6950020	Countertop, US only	13 $\frac{1}{2}$ x 16 $\frac{1}{2}$ x 4 (33.3 x 41.9 x 10.2)	120 AC	1.8	15	5-15P	1
6951020	Countertop, Canada only	13 $\frac{1}{2}$ x 16 $\frac{1}{2}$ x 4 (33.3 x 41.9 x 10.2)	120 AC	1.4	12	5-15P	1

Ultra Series Induction Ranges

- Designed for large-volume and heavy-duty usage
- 100 power settings for precise cooking control
- 90% efficiency versus 40% for gas stoves



69504



69507



ITEM #	DESCRIPTION	MAX PAN SIZE: IN (CM)	DIMENSIONS (W X D X H) IN (CM)	VOLTAGE	MAX KW	AMPS	PLUG	CASE LOT
69504	Countertop	14 (35.6)	15 $\frac{1}{8}$ x 18 $\frac{1}{2}$ x 5 $\frac{3}{4}$ (40.3 x 47 x 14.6)	208/240 AC	3.5	14.6	6-20P	1
69505**	Drop-in	14 (35.6)	17 $\frac{3}{8}$ x 16 $\frac{1}{2}$ x 4 $\frac{3}{4}$ (44.1 x 41.9 x 12)	208/240 AC	3.5	14.6	6-20P	1
69507	Dual-hob countertop front to back	12 (30.5)	15 $\frac{7}{8}$ x 29 $\frac{3}{4}$ x 5 $\frac{9}{16}$ (40.3 x 75.6 x 14.8)	208/240 AC	3.5*	29.2	6-50P	1
69508**	Dual-hob drop-in front to back	12 (30.5)	17 $\frac{3}{8}$ x 27 $\frac{7}{8}$ x 5 $\frac{1}{8}$ (44.1 x 70.8 x 13)	208/240 AC	3.5*	29.2	6-50P	1
INTERNATIONAL MODEL #S***								
6950502							Schuko	
6950503	Single-hob drop-in	12 (30.5)	17 $\frac{3}{8}$ x 16 $\frac{1}{2}$ x 4 $\frac{3}{4}$ (44.1 x 41.9 x 12)	240 AC	3.5	14.6	UK	1
6950505							Australian	

*Per Hob **69505/69508 Control Box Cutout Dimensions: 7" x 3 $\frac{3}{8}$ " (18.4 x 9.8 cm) – Note: 1 Control Per Hob
 ***International Models – for export only, CE Listed

Professional Series Induction Ranges

- Designed for sauté, saucepots, and small stockpots
- 100 settings for precise cooking control – set to power level or temperature setting



6954703
6954704



69523



ITEM #	DESCRIPTION	MAX PAN SIZE: IN (CM)	DIMENSIONS (W X D X H) IN (CM)	VOLTAGE	MAX KW	AMPS	PLUG	CASE LOT
6954301	Single-hob countertop**	14 (35.6)	13 $\frac{1}{8}$ x 16 $\frac{1}{4}$ x 4 (32.7 x 41.9 x 10.2)	208/240 AC	2.6	10.8	6-20P	1
69520	Single-hob countertop	14 (35.6)	16 x 17 $\frac{3}{4}$ x 6 (40.1 x 45.1 x 15.2)	208/240 AC	2.9	12.1	6-20P	1
69521*	Single-hob drop-in	14 (35.6)	17 $\frac{7}{8}$ x 16 $\frac{3}{4}$ x 4 $\frac{1}{2}$ (44.8 x 42.5 x 11.4)	208/240 AC	2.9	12.1	6-20P	1
69522	Dual-hob countertop front to back	12 (30.5)	15 $\frac{7}{8}$ x 29 $\frac{3}{4}$ x 5 $\frac{9}{16}$ (40.4 x 75.6 x 14.8)	208/240 AC	2.9 per hob	24	6-30P	1
69523	Dual-hob countertop side by side	12 (30.5)	26 $\frac{5}{8}$ x 18 $\frac{3}{8}$ x 5 $\frac{1}{2}$ (67.6 x 46.7 x 14)	208/240 AC	2.9 per hob	24.1	6-30P	1
69524*	Dual-hob drop-in front to back	12 (30.5)	17 $\frac{3}{8}$ x 27 $\frac{7}{8}$ x 4 $\frac{3}{4}$ (44.1 x 70.8 x 12.1)	208/240 AC	2.9 per hob	24.2	6-30P	1
INTERNATIONAL MODEL #S***								
6954302**							Schuko	
6954303**							UK	
6954304**	Single-hob countertop	14 (35.6)	13 $\frac{1}{8}$ x 16 $\frac{1}{4}$ x 4 (32.7 x 41.9 x 10.2)	208/240 AC	2.6	10.8	China	1
6954305**							Australian	
6952105	Single-hob drop-in	14 (35.6)	17 $\frac{7}{8}$ x 16 $\frac{3}{4}$ x 4 $\frac{1}{2}$ (44.8 x 42.5 x 11.4)	208/240 AC	2.9	12.1	Australian	1
6954702**								
6954703**	Dual-hob countertop front to back	12 (30.5)	13 $\frac{3}{8}$ x 26 $\frac{5}{8}$ x 5 $\frac{9}{16}$ (34 x 67.6 x 14.8)	208/240 AC	1.9 per hob	15.8	China	1
6954704**								

*69521 and 69524 Control Box Cutout Dimensions: 7" x 3 $\frac{3}{8}$ " (18.4 x 9.8 cm)
 6954301, 6954302 to 6954305, and 6954702 to 6954704 are manufactured by Vollrath China *International Models – for export only, CE Listed

Induction Fajita Skillet Heaters

- Simple one-touch operation produces perfect results in record time, every time
- Ranges work with the two standard fajita pan styles and heat room-temperature pans to proper sizzle temperatures

69504F THREE PRESETS, 3,000-3,500 WATTS POWER:

- Setting 1: 80 seconds, 450-550°F; 230-288°C
- Setting 2: 30 seconds, 300-350°F; 149-177°C
- Setting 3: 60 seconds, 400-500°F; 204-260°C

2 TWO YEAR WARRANTY

59500F, 59510F SINGLE PRESET, 1,440-1,800 WATTS POWER:

- 59500F – Heat: 120 seconds, 450-550°F; 204-206°C
- 59510F – Heat: 140 seconds, 450-550°F; 204-206°C

1 ONE YEAR WARRANTY

6954302F, 6954303F TWO PRESETS:

- Setting 1 – Heat: 60 seconds, 204-206°C
- Setting 2 – Reheat: 15 seconds, 204-206°C



Ultra Fajita Heater
69504F



Mirage® Fajita
Heater 59500F



Skillets and liners for
demonstration only.
Not a Vollrath product.



ITEM #	DESCRIPTION	DIMENSIONS (W X D X H): IN (CM)	VOLTAGE	MAX KW	AMPS	PLUG	CASE LOT
59500F	Mirage Fajita – induction cast iron pan heater (US)	14 x 15 x 3 (35.6 x 38.1 x 7.6)	120 AC	1.8	15	5-15P	1
59510F	Mirage Fajita – induction cast iron pan heater (Canada)	14 x 15 x 3 (35.6 x 38.1 x 7.6)	120 AC	1.4	12	5-15P	1
69504F	Ultra Fajita – induction cast iron pan heater (US/Canada)	15 ⁷ / ₈ x 18 ¹ / ₂ x 5 ³ / ₄ (40.3 x 47 x 14.6)	208/240 AC	3.5	14.6	6-20P	1
INTERNATIONAL COUNTERTOP SIZZLE PLATTER INDUCTION HEATERS*							
6954302F	Pro Sizzle Platter induction heater	13 ¹ / ₂ x 16 ¹ / ₂ x 5 ³ / ₄ (32.7 x 41.9 x 10.2)	230	2.6	10.8	Schuko	1
6954303F	Pro Sizzle Platter induction heater	13 ¹ / ₂ x 16 ¹ / ₂ x 5 ³ / ₄ (32.7 x 41.9 x 10.2)	230	2.6	10.8	UK	1

*International Models – for export only, CE Listed

NOTE: These units are specifically designed for heating skillets to sizzle temperatures from room temperature, where the skillets are heated, then finished foods are plated and oil/water is added to create the fajita sizzle effect. They are not designed for use in other applications or to directly cook the food.



**MAKE YOUR INDUCTION
BUFFET PRESENTATION UPSCALE**

See pages 199-200 for more information

CONVEYOR TOASTERS & OVENS

NEW Conveyor Toasters & Ovens

A TOAST, TO TOAST

Cheers to a new collection of conveyor toasters and ovens from Vollrath. No stranger to the kitchen, as the #1 rated restaurant supplier, we're bringing an even more complete line of professional solutions to the table. From toast and bagels to pizza and toasted sandwiches, find out why the restaurant world has even more reason to celebrate. Visit VOLLRATH.com/toast.

Conveyor Toasters



Forced convection and energy-efficient quartz heaters provide even and fast toasting. The complete line includes units for a wide variety of applications. Choose a toaster that meets your needs for standard toast as well as buns, bagels, and other specialty bread items.

Pages 35-37

Contact Toasters



Saves space on the flat-top by quickly and consistently toasting high volumes of buns. The dual-sided platen provides perfect toasting that helps keep buns from getting soggy, making this unit ideal for burger chains.

Page 38

Convertible Toasters



Vollrath's convertible conveyor toasters feature the benefits of two units in the footprint of one. This all-in-one solution quickly and easily converts from standard toaster to pass-through providing the flexibility for medium-volume restaurants to toast bread, bagels, and sandwiches and melt cheese.

Page 38

Conveyor Pizza Ovens

Provide precise and repeatable results for baking fresh dough and par-baked pizzas, flat breads, calzones, and garlic or cheese bread. They offer flexibility and convenience for operations that offer pizza in addition to other menu items.

Page 39



Conveyor Sandwich Ovens

Deliver consistently toasted bread while melting cheese and warming meat. Units available for low- or high-volume applications, such as sandwich shops.

Page 40



Cheese Melters/Finishing Ovens

Great for melting cheese on top of a variety of menu items as well as finishing entrées.

Page 41



CONVEYOR TOASTERS

OVERALL CONVEYOR TOASTER FEATURES AND BENEFITS:

- Forced convection toasting promotes uniform results and energy efficiency
- Most models have energy-efficient, fast-reacting quartz heaters
- Standby mode saves up to 75 percent energy during slow periods when unit is not in use and allows unit to quickly return to full power
- Variable speed control to achieve desired color
- Maintenance-free drive system; stainless steel drive chain does not require lubrication

NEW Conveyor Toasters (JT1 & JT1H)

- Speed control only
- 2-slice, 10½" wide conveyor belt
- For low-volume and self-serve applications or when replacing pop-ups



JT1

ONE-SIDED TOASTING OPTION

ITEM #	FOOD PRODUCT TYPE	PRODUCT OPENING HEIGHT IN (CM)	VOLTAGE	OUTPUT	INTENDED OPERATION TYPE	ONE-SIDED TOASTING OPTION
JT1						
CT2-120350	Standard breads	1 ½" (3.8)	120	Up to 350 slices or bun halves per hour	Low-volume and self-serve applications or when replacing pop-up toasters	–
JT1H						
CT2H-120250	Standard breads, specialty breads, buns & bagels	2 ½" (6.4)	120	Up to 250 slices or bun halves per hour	Low-volume and self-serve applications or when replacing pop-up toasters	–

International models available - visit vollrath.com/toasters

NEW Conveyor Toasters (JT1B & JT1BH)

- Speed control only
- One-sided toasting option – toggle between full heat and one-sided top-heat toasting only for bagels or buns
- 2-slice, 10½" side conveyor belt
- For low-volume and self-serve applications or when replacing pop-ups



JT1BH

ONE-SIDED TOASTING OPTION

ITEM #	FOOD PRODUCT TYPE	PRODUCT OPENING HEIGHT IN (CM)	VOLTAGE	OUTPUT	INTENDED OPERATION TYPE	ONE-SIDED TOASTING OPTION
JT1B						
CT2B-120500	Standard breads, buns & bagels	1 ½" (3.8)	120	Up to 500 slices or bun halves per hour	Self-serve or mid-size-volume applications, one-sided toasting option	✓
JT1BH						
CT2BH-120400	Standard breads, specialty breads, buns & bagels	1½"-3" (3.8-7.6), adjustable	120	Up to 400 slices or bun halves per hour	Self-serve or mid-size-volume applications, one-sided toasting option	✓

International models available - visit vollrath.com/toasters

NEW Conveyor Toasters (JT2 & JT2H)

- Variable top & bottom heat controls, in addition to speed control
- 2-slice, 10½" wide conveyor belt
- Mid-size-volume operations



JT2

ITEM #	FOOD PRODUCT TYPE	PRODUCT OPENING HEIGHT IN (CM)	VOLTAGE	OUTPUT	INTENDED OPERATION TYPE	ONE SIDED TOASTING OPTION
JT2						
CT4-120450			120	Up to 450-800		
CT4-208800	Standard breads	1-½" (3.8)	208	slices or bun halves	Mid-size-volume applications	–
CT4-240800			240	per hour		
JT2H						
CT4H-120300	Standard breads,		120	Up to 300-550		
CT4H-208550	specialty breads,	1½"-3" (3.8-7.6),	208	slices or bun halves	Mid-size-volume applications	–
CT4H-240550	buns & bagels	adjustable	240	per hour		

*220V models (CT4-220800 and CT4H-220550) are made to order. Contact your Vollrath representative.

International models available - visit vollrath.com/toasters

NEW Conveyor Toasters (JT2B)

- One-sided toasting only
- 2-slice, 10½" wide conveyor belt
- Designed for high-volume bagel chains



JT2B

ITEM #	FOOD PRODUCT TYPE	PRODUCT OPENING HEIGHT IN (CM)	VOLTAGE	OUTPUT	INTENDED OPERATION TYPE	ONE-SIDED TOASTING OPTION
JT2B*						
CT4B-2081200*			208	Up to 1,200 bagel or	High-volume applications,	
CT4B-2401200*	Buns & bagels	2¼" (5.7)	240	bun halves per hour	one-sided only	✓

*Model JT2B has heavy-duty metal-sheathed heating elements.

International models available - visit vollrath.com/toasters

NEW Conveyor Toasters (JT3 & JT3H)

- Variable top & bottom heat controls, in addition to speed control
- 3-slice, 14½" wide conveyor belt
- High volume



JT3

ITEM #	FOOD PRODUCT TYPE	PRODUCT OPENING HEIGHT IN (CM)	VOLTAGE	OUTPUT	INTENDED OPERATION TYPE	ONE-SIDED TOASTING OPTION
JT3						
CT4-2081000			208	Up to 1,000 slices or	High-volume applications	–
CT4-2401000	Standard breads	1 ½" (3.8)	240	bun halves per hour		
JT3H						
CT4H-208950	Standard breads,		208	Up to 950 slices or	High-volume applications	–
CT4H-240950	specialty breads,	1½"-3" (3.8-7.6),	240	bun halves per hour		
	Buns & Bagels	adjustable				

*220V models (CT4-2201000 and CT4H-220950) are made to order. Contact your Vollrath representative.

International models available - visit vollrath.com/toasters

NEW Conveyor Toasters (JT3BH)

- Variable top & bottom heat controls, in addition to speed control
- One-sided toasting option – toggle between full heat and one-sided top heat toasting only for bagels or buns
- 3-slice, 14½" wide conveyor belt
- High volume that needs versatility



JT3BH

ITEM #	FOOD PRODUCT TYPE	PRODUCT OPENING HEIGHT IN (CM)	VOLTAGE	OUTPUT	INTENDED OPERATION TYPE	ONE-SIDED TOASTING OPTION
JT3BH						
CT4BH-2081400	Standard breads, specialty breads	1½"-3" (3.8-7.6), adjustable	208	Up to 1,400 slices or bun halves per hour	High-volume applications	✓
CT4BH-2401400	buns & bagels		240			

*220V model CT4BH-2201400 is made to order. Contact your Vollrath representative.

International models available - visit vollrath.com/toasters

NEW Conveyor Toasters (JT2000)

- Variable top & bottom heat controls, in addition to speed control
- One-sided toasting option – toggle between full heat and one-sided top heat toasting only for bagels or buns
- 3-slice, 14½" wide conveyor belt
- Highest volume – commissaries, institutions, military – fast, short-duration feeding



JT2000

ITEM #	FOOD PRODUCT TYPE	PRODUCT OPENING HEIGHT IN (CM)	VOLTAGE	OUTPUT	INTENDED OPERATION TYPE	ONE SIDED TOASTING OPTION
JT2000						
CT4-2082000	Standard breads, buns & bagels	1¾" (4.5)	208	Up to 2,000 slices or bun halves per hour	High-volume application	✓
CT4-2402000			240			

*220V model CT4-2202000 is made to order. Contact your Vollrath representative.

International models available - visit vollrath.com/toasters

NEW Dual Conveyor Toasters (JT4)

- Two toasters in the footprint of one
- Independent top & bottom heat controls, speed control & standby mode
- Extremely versatile – best used when two different breads are required at the same time
- Medium-volume operations



JT4

ITEM #	FOOD PRODUCT TYPE	PRODUCT OPENING HEIGHT IN (CM)	VOLTAGE	OUTPUT	INTENDED OPERATION TYPE	ONE-SIDED TOASTING OPTION
JT4						
CT4-208DUAL	Standard breads, specialty breads, buns & bagels	Top chamber 1½"-3" (3.8-7.6) adjustable; bottom chamber 1½" (3.8) adjustable	208	Up to 1,400 slices or bun halves per hour combined	Mid-size-volume applications that need to toast different items simultaneously	–
CT4-240DUAL			240			

*220V model CT4-220DUAL is made to order. Contact your Vollrath representative.

International models available - visit vollrath.com/toasters

NEW Convertible Toasters (JT2HC & JT3HC)

- Variable top and bottom heat controls, in addition to speed controls
- Quickly and easily converts from standard toaster to pass-through, offering the benefits of two units in the footprint of one
- Provides flexibility to toast bread and bagels as well as toast sandwiches and melt cheese in one unit.



JT3HC
Converts to pass-through toaster!



ITEM #	FOOD PRODUCT TYPE	PRODUCT OPENING WIDTH IN (CM)	VOLTAGE	OUTPUT	INTENDED OPERATION TYPE	ONE-SIDED TOASTING OPTION
JT2HC						
CVT4-120300	Standard breads, sandwiches	2-slice	120	Up to 300 slices per hour	Mid-size-volume applications that need flexibility to toast bread and bagels as well as toast sandwiches and melt cheese	-
CVT4-208550		10½" (26.7cm)	208	Up to 550 slices per hour		
CVT4-240550			240	Up to 550 slices per hour		
JT3HC						
CVT4-208900	Breads, sandwiches, finishing entrées	3-slice	208	Up to 900 slices per hour	High-volume applications that need flexibility to toast bread and bagels as well as toast sandwiches and melt cheese	-
CVT4-240900		14½" (36.8cm)	240	Up to 900 slices per hour		

*220V models (CVT4-220550 and CVT4-220900) are made to order. Contact your Vollrath representative.

International models available - visit vollrath.com/toasters

NEW Dual Conveyor Convertible Toasters (JT4HC)

- Our most versatile unit toasts different items simultaneously
- Variable top and bottom heat controls, in addition to speed controls
- Top chamber quickly and easily converts from standard toaster to pass-through
- Provides flexibility to toast bread and bagels as well as toast sandwiches and melt cheese in one unit



JT4HC



ITEM #	FOOD TYPE	PRODUCT OPENING WIDTH IN (CM)	VOLTAGE	OUTPUT	INTENDED OPERATION TYPE	ONE-SIDED TOASTING OPTION
JT4HC						
CVT4-208DUAL	Standard breads, specialty breads, sandwiches, finishing entrées, buns & bagels	14½" (36.8cm)	208	Up to 1,100 slices per hour	Mid-size-volume extremely versatile, toasts different items simultaneously	-
CVT4-240DUAL			240			

*220V model CVT4-220DUAL is made to order. Contact your Vollrath representative.

International models available - visit vollrath.com/toasters

NEW Contact Toasters (CBT15)

- Aluminum platen smoothly toasts buns so they hold up to juicy burgers and sauces
- Two openings for maximum loading capacity
- Independent variable speed controls for each opening
- Vertical, countertop design improves kitchen efficiency by moving bun toasting off flat top
- Two product openings between ½"-1" can be adjusted with spring-loaded pressure plate to accommodate different types of buns



CBT15



ITEM #	FOOD PRODUCT TYPE	VOLTAGE	INTENDED OPERATION TYPE
CBT15			
VCT4-208	Buns	208	High-volume applications that exclusively toast buns
VCT4-240		240	

ACCESSORIES

351032	Release Sheets (2) for CBT15
351034	Butter Wheel* for CBT15

*Butter Wheel not NSF certified

International models available - visit vollrath.com/toasters

CONVEYOR OVENS

CONVEYOR OVEN FEATURES AND BENEFITS:

- Variable speed control allows for real-time adjustments
- MGD & JPO Models: thermostatic top and bottom heat controls to achieve desired results
- Forced convection promotes uniform results and energy efficiency
- Energy-efficient, fast-reacting quartz heaters
- Maintenance-free drive system; stainless steel drive chain does not require lubrication
- Meant for operations that regularly produce medium volumes of fresh or par-baked pizza or flatbreads. Not intended to bake frozen pizza or cook raw food or raw toppings.
- Not intended for pizzerias

NEW Digital Pizza Oven (MGD18)

- Change conveyor direction with the push of a button
- 4 independent, thermostatically controlled zones
- Digital controls, 6 programmable settings
- Includes loading & receiving trays
- UL tested & verified for ventless operation, meets or surpasses EPA 202



MGD18



ITEM #	FOOD PRODUCT TYPE	PRODUCT OPENING HEIGHT IN (CM)	VOLTAGE	PRODUCT OPENING WIDTH IN (CM)	INTENDED OPERATION TYPE
MGD18					
PO6-20818	Fresh dough, par-baked pizzas, flatbreads	1½"-4" (3.8-10.2) adjustable	208	18" (45.7)	Operations that regularly produce medium volumes of pizza, flatbread, or calzones. Digitally controlled.
PO6-24018			240		
ACCESSORIES					
351037	Dual Oven Stacking Spacer for JPO18/MGD18				

*220V model PO6-22018 is made to order. Contact your Vollrath representative.

NEW Conveyor Pizza Ovens (JPO14/JPO18)

- Specific left and right belt direction
- Thermostatically controlled heating elements
- Includes loading & receiving trays
- UL tested & verified for ventless operation, meets or surpasses EPA 202



JPO14



ITEM #	FOOD PRODUCT TYPE	PRODUCT OPENING HEIGHT IN (CM)	VOLTAGE	PRODUCT OPENING WIDTH IN (CM)	INTENDED OPERATION TYPE
JPO14					
PO4-20814L-R	Fresh dough, par-baked pizzas & flatbreads	1½"-4" (3.8-10.2) adjustable	208	14" (35.6)	Operations that regularly produce medium volumes of pizza or flatbread.
PO4-20814R-L					
PO4-24014L-R			240		
PO4-24014R-L					
JPO18					
PO4-20818L-R	Fresh dough, par-baked pizzas & flatbreads	1½"-4" (3.8-10.2) adjustable	208	18" (45.7)	Operations that regularly produce medium volumes of pizza or flatbread.
PO4-20818R-L					
PO4-24018L-R			240		
PO4-24018R-L					
ACCESSORIES					
351036	Dual Oven Stacking Spacer for JPO14/JPO18				
351037	Dual Oven Stacking Spacer for JPO18/MGD18				

*220V models (PO4-22014L-R, PO4-22014R-L, PO4-22018L-R, and PO4-22018R-L) are made to order. Contact your Vollrath representative.

NEW Conveyor Sandwich Ovens (JSO14)

- Ideal for high-volume sandwich shops
- Specific left and right belt direction
- Phase-controlled heating elements
- Includes loading & receiving trays
- UL tested & verified for ventless operation, meets or surpasses EPA 202



JSO14

ITEM #	FOOD PRODUCT TYPE	PRODUCT OPENING HEIGHT IN (CM)	VOLTAGE	PRODUCT OPENING WIDTH IN (CM)	INTENDED OPERATION TYPE
JSO14					
SO4-20814L-R			208		
SO4-20814R-L	Sandwiches & finishing entrées	1½"-4" (3.8-10.2) adjustable		14" (35.6)	Operations that regularly produce high volumes of toasted sandwiches
SO4-24014L-R			240		
SO4-24014R-L					

ACCESSORIES

351036 Dual Oven Stacking Spacer for JSO14

*220V models (SO4-22014R-L and SO4-22014L-R) are made to order. Contact your Vollrath representative.

NEW Conveyor Sandwich Ovens (JB2H & JB3H)

- Ideal for low volume sandwich shops or small restaurants
- UL tested & verified for ventless operation, meets or surpasses EPA 202

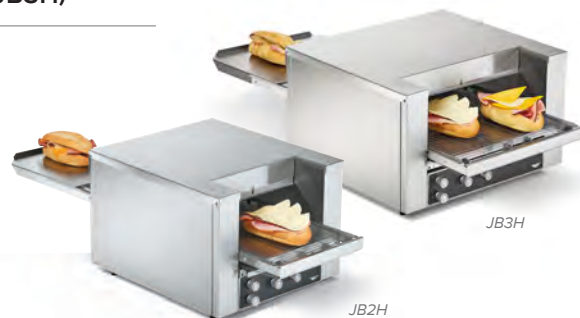

JB2H

JB3H

ITEM #	FOOD PRODUCT TYPE	PRODUCT OPENING HEIGHT IN (CM)	VOLTAGE	PRODUCT OPENING WIDTH IN (CM)	INTENDED OPERATION TYPE
JB2H					
SO2-12010.5			120		
SO2-20810.5	Sandwiches	1½"-3" (3.8-7.6) adjustable	208	10.5" (26.7)	Operations with a low volume of toasted sandwiches or looking to add them to the menu, toasting bread, or melting cheese
SO2-24010.5			240		
JB3H					
SO2-20814.5	Sandwiches & finishing entrées	1½"-3" (3.8-7.6) adjustable	208	14.5" (36.8)	Operations with a low volume of toasted sandwiches or looking to add them to the menu, toasting bread, or melting cheese
SO2-24014.5			240		

ACCESSORIES

351038 Dual stacking spacer for JB2H

351042 Dual stacking spacer for JB3H

*220V models (SO2-22010.5 and SO2-22014.5) are made to order. Contact your Vollrath representative.

NEW Cheese Melters/Finishing Ovens (JW1 & JW2)

- Compact Cheese Melters / Finishing Ovens are ideal for melting cheese, finishing entrées, or warming plates in medium-volume operations
- Five shelf positions
- 15-minute timer; unit then returns to standby mode and 25% power
- Standby mode saves 75% power during off-peak times
- Feature energy-efficient, fast-reacting quartz heating elements



JW1



JW2



ITEM #	WIDTH IN (CM)	VOLTAGE	PRODUCT OPENING WIDTH IN (CM)	INTENDED OPERATION TYPE
JW1				
CM2-12020	20" (50.8)	120	12½" (31.8)	Medium-volume applications and small restaurants, compact
JW2				
CM2-12026	26" (66)	120	20¼" (51.4)	Medium-volume applications and small restaurants
ACCESSORIES				
351035	Wall Mount Bracket for Cheese Melters			

NEW Cheese Melters/Finishing Ovens (JW30 & JW30PA)

- Compact Cheese Melters / Finishing Ovens are ideal for melting cheese, finishing entrées, or warming plates in high-volume operations
- Five shelf positions
- JW30 has 15-minute timer; unit then returns to standby mode and 25% power
- JW30PA is plate activated – weight of plate brings unit from standby mode to full power
- Standby mode saves 75% power during off-peak times
- Feature heavy-duty, metal-sheathed heating elements



JW30



JW30PA



ITEM #	WIDTH IN (CM)	PLATE ACTIVATED	VOLTAGE	PRODUCT OPENING WIDTH IN (CM)	INTENDED OPERATION TYPE
JW30					
CM4-20835	35" (88.9)	-	208	28½" (72.4)	Higher-volume applications such as large restaurants, heavy-duty
CM4-24035	35" (88.9)	-	240	28½" (72.4)	Higher-volume applications such as large restaurants, heavy-duty
JW30PA					
CM4-20835PA	35" (88.9)	✓	208	28½" (72.4)	Higher-volume applications such as large restaurants, heavy-duty
CM4-24035PA	35" (88.9)	✓	240	28½" (72.4)	Higher-volume applications such as large restaurants, heavy-duty
ACCESSORIES					
351035	Wall Mount Bracket for Cheese Melters				



SPECIALTY OVENS



40704

Cayenne® Chicken Rotisserie Ovens

- Easy-to-load baskets for ribs, roasts, vegetables, an entire rack of lamb, or delicate items like whole stuffed fish
- Thermostatically controlled for consistent results
- Unique circulation fan design distributes consistent heat throughout the chamber for even cooking and browning
- Glass front and rear for excellent point-of-sale display



ITEM #	MODEL #	DESCRIPTION*	DIMENSIONS (W X D X H): IN (CM)	COOKING CHAMBER DIMENSIONS (W X D X H): IN (CM)	WATTS	VOLTAGE	AMPS	PLUG	CASE LOT
40704	CGA8008	8-bird rotisserie oven	29¼ x 20¼ x 23¼ (74.3 x 51 x 58.7)	18½ x 19½ x 18½ (47.5 x 49.5 x 46)	2700	220	12	6-15P	1
40841	CGA8016	15-bird rotisserie oven	37 x 21½ x 26½ (94 x 55 x 66.3)	26¾ x 21¼ x 19¾ (67.2 x 54.5 x 49.7)	5000	220	22	6-30P	1

*Oven capacities based on use of 3lb chickens

Cayenne Pizza/Bake Oven

- Even heat of the hearth stones and higher temperature capability for crisp, light, evenly baked pizzas
- Oven supplied with two hearth-bake decks for crisp, even browning of crust and breads
- Shelf size: 17½" x 17½" (44.5 x 44.5 cm)
- 2½" (6.4 cm) between shelves
- Heat setting: 140°-750°F (60°-399°C)



40848

ITEM #	MODEL #	DESCRIPTION	OVERALL DIMENSIONS (W X D X H): IN (CM)	COOKING CHAMBER SIZE (W X D X H): IN (CM)	WATTS	VOLTAGE	AMPS	PLUG	CASE LOT
40848	POA8002	Pizza/bake oven	23¾ x 25¾ x 20 (58.8 x 64.5 x 51.4)	18½ x 19¾ x 9¾ (47 x 48.7 x 23.9)	2100-2800	208-240	10.1-11.6	6-15P	1

Cayenne Convection Ovens

- Custom baffle fan and specially designed diffuser plate create consistent air flow and even, reliable baking
- Insulated double-wall construction for thermal efficiency and cooler exterior
- Temperature range: 150°-570°F (66°-299°C)
- Full size has steam injection for crispy bread crusts



40702

40701

ITEM #	MODEL #	DESCRIPTION	NUMBER OF SHELVES	DIMENSIONS (W X D X H): IN (CM)	COOKING CHAMBER SIZE (W X D X H): IN (CM)	WATTS	VOLTAGE	AMPS	PLUG	CASE LOT
40703	COA7002	Half-size	3	23¾ x 24½ x 18¾ (59.5 x 62.2 x 45.8)	18½ x 13 x 8¾ (47 x 33 x 21.8)	1400	120	11.6	5-15P	1
40701	COA8004	Half-size	4	23¾ x 24½ x 23¼ (59.5 x 62.2 x 59)	18½ x 13 x 13¾ (47 x 33 x 35)	2400	230	11	6-15P	1
40702	COA8005	Full-size	4	32¾ x 29¾ x 26¾ (83.7 x 75.5 x 66.5)	27¾ x 19¾ x 13¾ (70.2 x 49.4 x 35)	1330-5760	208-240	20.8-24	6-30P	1

Microwave Ovens

- Stainless steel exterior with interior ceramic bottom plate
- Digital display and timer
- Output: 1000 watts
- .9 cu ft cooking chamber



DIGITAL MICROWAVE OVEN

- Three power levels
- 20 programmable settings

MANUAL MICROWAVE OVEN

- Manual control
- 6 power levels



40830



40819

ITEM #	MODEL #	DESCRIPTION	OVERALL DIMENSIONS (W X D X H): IN (CM)	COOKING CHAMBER DIMENSIONS (W X D X H): IN (CM)	VOLTAGE	AMPS	PLUG	CASE LOT
40819	MWA7025	Digital	20½ x 18⅝ x 12¼ (52.1 x 46 x 31.1)	13⅝ x 14⅜ x 7⅞ (33.3 x 36.5 x 19.8)	120	12.1	5-15P	1
40830	MWA7125	Manual	20½ x 18⅝ x 12¼ (52.1 x 46 x 31.1)	13⅝ x 14⅜ x 7⅞ (33.3 x 36.5 x 19.8)	120	12.1	5-15P	1

EQUIPMENT STANDS

Medium- and Heavy-Duty Equipment Stands



4087948 - HD Mobile

40740 - HD Stationary

MEDIUM-DUTY

- Stainless steel top for long working life
- Back and side splashes contain spills and keep equipment securely on table
- Height-adjustable, galvanized bottom shelf for convenient working storage

HEAVY-DUTY

- Full marine edge contains spills and keeps equipment securely on table
- Stainless steel top and undershelf for long working life
- Available with 5" (12.7 cm) caster



Adjustable feet optimize height and stability.

ITEM #	DESCRIPTION	DIMENSIONS (W X D X H): IN (CM)	CASE LOT
4087924	24" heavy-duty stand, mobile	24 x 30 x 24 (61 x 76.2 x 61)	1
4087936	36" heavy-duty stand, mobile	36 x 30 x 24 (91.4 x 76.2 x 61)	1
4087948	48" heavy-duty stand, mobile	48 x 30 x 24 (121.9 x 76.2 x 61)	1
40740	24" medium-duty stand	24 x 26 x 24 (61 x 61 x 66)	1
40741	36" medium-duty stand	36 x 26 x 24 (91.4 x 61 x 66)	1
40742	48" medium-duty stand	48 x 26 x 24 (121.9 x 61 x 66)	1

PERFECT FOR MEDIUM-DUTY & HEAVY-DUTY GRIDDLES & CHARBROILERS



Found on pages 45-46

RANGES & ROLLER GRILLS

Cayenne® Gas Ranges

- 26,000 BTU per burner
- Full-width stainless steel drip pan
- Each burner has a grate for easier handling and cleaning



Knobs guaranteed for life



ITEM #	MODEL #	DESCRIPTION	NUMBER OF BURNERS	DIMENSIONS (W X D X H): IN (CM)	OUTPUT (BTU)	CASE LOT
40736	HPA1002	12" gas hot plate	2	12 x 27 x 13 $\frac{3}{8}$ (30.5 x 68.6 x 34)	52,000	1
40737	HPA1004	24" gas hot plate	4	23 $\frac{5}{8}$ x 27 x 13 $\frac{3}{8}$ (60 x 68.6 x 34)	104,000	1
40738	HPA1006	36" gas hot plate	6	35 $\frac{1}{2}$ x 27 x 13 $\frac{3}{8}$ (90.2 x 68.6 x 34)	156,000	1

Electric Hot Plate

- 9" (22.9 cm) solid plate burners (front-back) for faster, more even heating and easier cleanup
- Ships with installed cord and plug for convenient installation
- Stainless steel construction for durability and long life
- Rear safety skirt



40739 cookware not included

ITEM #	MODEL #	DESCRIPTION	DIMENSIONS (W X D X H): IN (CM)	WATTS	VOLTAGE	AMPS	PLUG	CASE LOT
40739	STA8002	Flat top electric hot plate – 8 $\frac{1}{8}$ " (22 cm) dia solid plates front and rear	15 x 27 $\frac{3}{8}$ x 11 $\frac{1}{8}$ (38.1 x 69.5 x 29.3)	3000-4000	208-240	14.4-16.7	6-30P	1

Cayenne Hot Dog Roller Grills

- Stainless steel construction for durability and easy cleaning
- 360-degree rotation for even heating and effective merchandising
- 40821 and 40822 feature front and rear variable temperature controls for use with different menu items
- Breath guards sold separately



40824



ITEM #	MODEL #	# OF ROLLERS	HOT DOG CAPACITY	DIMENSIONS (W X D X H): IN (CM)	WATTS	VOLTAGE	AMPS	PLUG	CASE LOT	BREATH GUARD	DIMENSIONS (W X D X H): IN (CM)	CASE LOT
40820	HDR5005	5	12	23 x 10 x 10 (58.4 x 25.4 x 25.4)	400	120	3.3	5-15P	1	40823	27 x 10 x 12 (68.6 x 25.4 x 30.5)	1
40821	HDR5007	7	18	23 x 13 x 10 (58.4 x 33 x 25.4)	560	120	4.7	5-15P	1	40824	27 x 13 x 12 (68.6 x 33 x 30.5)	1
40822	HDR5009	9	24	23 x 16 x 10 (58.4 x 40.6 x 25.4)	720	120	6.0	5-15P	1	40825	27 x 16 x 12 (68.6 x 40.6 x 30.5)	1

CHARBROILERS & GRIDDLES

Cayenne® Heavy-Duty Charbroilers

- 2 x 20,000 BTU high-output burners for 40,000 BTU per 12" (30.5 cm) of cooking surface
- Burners placed every 6" (15.2 cm) for maximum coverage and control
- Charbroilers are shipped configured for lava rock, but include a radiant conversion kit



924CG

ITEM #	MODEL #	DESCRIPTION	DIMENSIONS (W X D X H): IN (CM)	OUTPUT (BTU)	NUMBER OF BURNERS	CASE LOT
924CG	CBL2024	24" heavy-duty radiant/lava rock charbroiler	24 x 31 x 17 ¹ / ₁₆ (61 x 78.7 x 43.3)	80,000	4	1
936CG	CBL2036	36" heavy-duty radiant/lava rock charbroiler	36 x 31 x 17 ¹ / ₁₆ (91.4 x 78.7 x 43.3)	120,000	6	1
948CG	CBL2048	48" heavy-duty radiant/lava rock charbroiler	48 x 31 x 17 ¹ / ₁₆ (121.9 x 78.7 x 43.3)	160,000	8	1
960CG	CBL2060	60" heavy-duty radiant/lava rock charbroiler	60 x 31 x 17 ¹ / ₁₆ (152.4 x 78.7 x 43.3)	200,000	10	1
972CG	CBL2072	72" heavy-duty radiant/lava rock charbroiler	72 x 31 x 17 ¹ / ₁₆ (182.9 x 78.7 x 43.3)	240,000	12	1

Cayenne Medium-Duty Charbroilers

- Burners placed every 6" (15.2 cm) for optimum heat distribution
- 40,000 BTU per 12" (30.5 cm) of cooking surface on models 18"-60" (45.7-152.4 cm)
- Shipped with lava rock, but includes radiant



407302

ITEM #	MODEL #	DESCRIPTION	DIMENSIONS (W X D X H): IN (CM)	OUTPUT (BTU)	NUMBER OF BURNERS	CASE LOT
40728*	CBL90122	12" medium-duty radiant/lava rock charbroiler	12 x 27 x 16 (30.5 x 68.6 x 40.6)	28,000	1	1
407292*	CBL90162	18" medium-duty radiant/lava rock charbroiler	18 x 27 x 16 (45.7 x 68.6 x 40.6)	60,000	3	1
407302	CBL90242	24" medium-duty radiant/lava rock charbroiler	24 x 27 x 16 (61 x 68.6 x 40.6)	80,000	4	1
407312	CBL90362	36" medium-duty radiant/lava rock charbroiler	36 x 27 x 16 (91.4 x 68.6 x 40.6)	120,000	6	1
407372	CBL90482	48" medium-duty radiant/lava rock charbroiler	48 x 27 x 16 (121.9 x 68.6 x 40.6)	160,000	8	1
407382	CBL90602	60" medium-duty radiant/lava rock charbroiler	60 x 27 x 16 (152.4 x 68.6 x 40.6)	200,000	10	1

*12" unit has single control

Cayenne Heavy-Duty Gas Griddles

- Shipped set up for natural gas; includes kit for conversion to propane
- 1" (2.5 cm) thick, stainless steel top plate is welded to the sides for even heat distribution and retention
- 30,000 BTU per 12" (30.5 cm) of cooking surface



948GGM

ITEM #	MODEL #	DESCRIPTION	DIMENSIONS (W x H x D): IN	OUTPUT (BTU)	NUMBER OF CONTROLS	CONTROL TYPE	CASE LOT
924GGM	FTG2024	24" heavy-duty griddle – manual control	24 x 31 x 17 ¹ / ₁₆	60,000	2	Manual valve	1
936GGM	FTG2036	36" heavy-duty griddle – manual control	36 x 31 x 17 ¹ / ₁₆	90,000	3	Manual valve	1
948GGM	FTG2048	48" heavy-duty griddle – manual control	48 x 31 x 17 ¹ / ₁₆	120,000	4	Manual valve	1
960GGM	FTG2060	60" heavy-duty griddle – manual control	60 x 31 x 17 ¹ / ₁₆	150,000	5	Manual valve	1
972GGM	FTG2072	72" heavy-duty griddle – manual control	72 x 31 x 17 ¹ / ₁₆	180,000	6	Manual valve	1

Cayenne® Heavy-Duty Thermostatic Gas Griddles

- 1" (2.5 cm) thick, stainless steel top plate is welded to the sides for even heat distribution and retention
- Snap-action thermostatic controls maintain user settings to ensure consistent surface temperature
- Mechanical safety pilots stand up to intense commercial cooking and ensure the gas will automatically shut off if the pilot goes out; no electrical setup needed



924GGT

ITEM #	MODEL #	DESCRIPTION	DIMENSIONS (W x H x D): IN	OUTPUT (BTU)	NUMBER OF CONTROLS	CONTROL TYPE	CASE LOT
924GGT	FTT2024	24" heavy-duty griddle – thermostatic control	24 x 31 x 17 ⁵ / ₁₆	60,000	2	Snap action thermostat	1
936GGT	FTT2036	36" heavy-duty griddle – thermostatic control	36 x 31 x 17 ⁵ / ₁₆	90,000	3	Snap action thermostat	1
948GGT	FTT2048	48" heavy-duty griddle – thermostatic control	48 x 31 x 17 ⁵ / ₁₆	120,000	4	Snap action thermostat	1
960GGT	FTT2060	60" heavy-duty griddle – thermostatic control	60 x 31 x 17 ⁵ / ₁₆	150,000	5	Snap action thermostat	1
972GGT	FTT2072	72" heavy-duty griddle – thermostatic control	72 x 31 x 17 ⁵ / ₁₆	180,000	6	Snap action thermostat	1

Cayenne Medium-Duty Gas Griddles

- 28,000 BTU per 12" (30.5 cm) of cooking surface
- Burners placed every 12" (30.5 cm) for maximum coverage and control
- Polished-surface 3/4" (1.9 cm) thick top plate



40720

ITEM #	MODEL #	DESCRIPTION	DIMENSIONS (W X D X H): IN (CM)	COOKING SURFACE DIMENSIONS (W X D): IN (CM)	OUTPUT (BTU)	CASE LOT
MANUALLY CONTROLLED GAS GRIDDLES						
40718	FTG9012	12" gas flat top griddle	12 x 27 x 16 (30.5 x 68.6 x 40.6)	11 ¹ / ₁₆ x 19 (29.7 x 48.3)	28,000	1
40719*	FTG9016	18" gas flat top griddle	18 x 27 x 16 (45.7 x 68.6 x 40.6)	17 ¹ / ₁₆ x 19 (45 x 48.3)	28,000	1
40720	FTG9024	24" gas flat top griddle	24 x 27 x 16 (61 x 68.6 x 40.6)	23 ³ / ₁₆ x 19 (60.2 x 48.3)	56,000	1
40721	FTG9036	36" gas flat top griddle	36 x 27 x 16 (91.4 x 68.6 x 40.6)	35 ⁵ / ₁₆ x 19 (90.7 x 48.3)	84,000	1
40839	FTG9048	48" gas flat top griddle	48 x 27 x 16 (121.9 x 68.6 x 40.6)	47 ⁷ / ₁₆ x 19 (121.2 x 48.3)	112,000	1
40840	FTG9060	60" gas flat top griddle	60 x 27 x 16 (152.4 x 68.6 x 40.6)	59 ⁹ / ₁₆ x 19 (151.6 x 48.3)	140,000	1
THERMOSTATICALLY CONTROLLED GAS GRIDDLES						
40722	FTA1024	24" gas flat top griddle	24 x 27 x 16 (61 x 68.6 x 40.6)	23 ³ / ₁₆ x 19 (60.2 x 48.3)	56,000	1
40723	FTA1036	36" gas flat top griddle	36 x 27 x 16 (91.4 x 68.6 x 40.6)	35 ⁵ / ₁₆ x 19 (90.7 x 48.3)	84,000	1

*18" unit has one burner

Cayenne Electric Flat Top Griddles

- Thermostatically controlled
- 120V, 14" (35.6 cm) unit (40715) is ideally sized for buffet, brunch, or catering applications
- All units ship with cord and plug installed



40716

ITEM #	MODEL #	DESCRIPTION	DIMENSIONS (W X D X H): IN (CM)	WATTS	VOLTAGE	AMPS	PLUG	CASE LOT
40715	FTA7016	14" electric flat top griddle	14 ¹ / ₄ x 20 x 11 (36.2 x 50.8 x 27.9)	1800	120	15	5-15P	1
40716	FTA8024	24" electric flat top griddle	24 x 20 x 11 (61 x 50.8 x 27.9)	3000	220	13.6	6-15P	1
40717	FTA8036	36" electric flat top griddle	36 x 20 x 11 (91.4 x 50.8 x 27.9)	8400	220	38	6-50P	1



SANDWICH PRESSES

EXPAND YOUR MENU WITH SANDWICH PRESSES

- PLATE DESIGN FEATURES INSET HEATING CHANNELS FOR GREATER HEATING EFFICIENCY
- THERMOSTATICALLY CONTROLLED FOR CONSISTENT RESULTS
- IDEAL FOR CUBAN AND ITALIAN SANDWICHES, TEXAS TOAST, AND MORE

Cayenne® Panini and Flat Plate Style

- Aluminum plate construction for superior heat distribution
- Adjustable handle allows user to set press height for even, consistent cooking
- 40790 features ribbed top and bottom for panini-style presentation
- 40790 and 40792 feature nonstick coating for easier cleaning
- 40793 features large plate size for high-volume output



ITEM #	MODEL #	DESCRIPTION	DIMENSIONS (W X D X H): IN (CM)	COOKING AREA (W X D): IN (CM)	WATTS	VOLTAGE	AMPS	PLUG	CASE LOT
40790	TSA7309	Panini style, nonstick	14 x 18¾ x 12½ (35.5 x 47.7 x 32.7)	13½ x 12¾ (33.8 x 31)	1800	120	15	5-15P	1
40791	TSA7009	Flat plate, natural finish	14 x 18¾ x 12½ (35.5 x 47.7 x 32.7)	13½ x 12¾ (33.8 x 31)	1800	120	15	5-15P	1
40792	TSA7109	Flat plate, nonstick	14 x 18¾ x 12½ (35.5 x 47.7 x 32.7)	13½ x 12¾ (33.8 x 31)	1800	120	15	5-15P	1
40793	TSA7012	Super-size flat plate, natural finish	18½ x 23¼ x 12½ (46 x 59 x 32.7)	17½ x 15½ (44.3 x 39.7)	1800	120	15	5-15P	1

Cayenne Cast Iron Plate, Panini Style

- Ribbed top and bottom plates for grilled food presentation
- Heavy-duty cast iron plates for durability and superior heat retention



ITEM #	MODEL #	DESCRIPTION	DIMENSIONS (W X D X H): IN (CM)	COOKING AREA (W X D): IN (CM)	WATTS	VOLTAGE	AMPS	PLUG	CASE LOT
40794	TSI7001	Single (US only)	16½ x 14¾ x 8½ (41 x 37.8 x 20.5)	16½ x 9¾ (41 x 24.4)	1800	120	15	5-20P	1
40795	TSI8002	Double (US only)	22¾ x 14¾ x 8½ (57 x 37.8 x 20.5)	22½ x 9¾ (57.2 x 24.4)	2700-3600	208-240	13-15	6-15P	1
40794-C	TSI7001	Single (US & Canada)	16½ x 14¾ x 8½ (41 x 37.8 x 20.5)	16½ x 9¾ (41 x 24.4)	1800	120	15	5-20P	1
40795-C	TSI8002	Double (US & Canada)	22¾ x 14¾ x 8½ (57 x 37.8 x 20.5)	22½ x 9¾ (57.2 x 24.4)	2700-3600	208-240	13-15	6-20P	1

FRYERS

SPECIALLY DESIGNED FOR QUICK HEAT-UP AND RECOVERY TIMES

- DUAL UNIT PROVIDES INCREASED VOLUME AND SEPARATION OF FOOD TYPES PREVENTING FLAVOR TRANSFER FROM OIL
- THERMOSTATICALLY CONTROLLED TO 374°F (190°C)
- “POWER ON” INDICATOR LIGHT
- SHIPS WITH TWO NICKEL-PLATED STEEL BASKETS PER WELL



Cayenne® 10 lb Standard-Duty Electric Fryers

- Ideal for small pubs, colleges, and product-specific applications
- Lift-out one-piece stainless steel tank with carrying handles for easier cleaning



ITEM #	MODEL #	DESCRIPTION	NUMBER OF WELLS	DIMENSIONS (W X D X H) IN (CM)	WATTS	VOLTAGE	AMPS	PLUG	CASE LOT
40705	FFA7110	Countertop fryer, 10 lb	1	10 ⁵ / ₁₆ x 17 ⁵ / ₈ x 10 ⁵ / ₁₆ (26.2 x 44.7 x 27.8)	1800	120	15	5-15P	1
40706	FFA8110	Countertop fryer, 10 lb	1	10 ⁵ / ₁₆ x 17 ⁵ / ₈ x 10 ⁵ / ₁₆ (26.2 x 44.7 x 27.8)	2500	220	11.3	6-15P	1
40707*	FFA7020	Dual countertop fryer, 2 x 10 lb	2	22 ⁵ / ₁₆ x 17 ⁵ / ₈ x 10 ⁵ / ₁₆ (57.3 x 44.7 x 27.8)	2 x 1800	120	2 x 15	2 x 5-15P	1
40708*	FFA8020	Dual countertop fryer, 2 x 10 lb	2	22 ⁵ / ₁₆ x 17 ⁵ / ₈ x 10 ⁵ / ₁₆ (57.3 x 44.7 x 27.8)	2 x 2500	220	2 x 11.3	2 x 6-15P	1

*Dual units feature two separate power cords and require two receptacles

Cayenne 15 lb Medium-Duty Electric Fryers

- Ideal for restaurants, canteens, and higher-volume outlets
- Fully welded oil tank with safety interlocked drain valve for easy drainage and cleaning



ITEM #	MODEL #	DESCRIPTION	NUMBER OF WELLS	DIMENSIONS (W X D X H) IN (CM)	WATTS	VOLTAGE	AMPS	PLUG	CASE LOT
40709	FFA8115	Countertop fryer with drain, 15 lb	1	11 ¹ / ₂ x 19 ³ / ₄ x 16 (29.2 x 50.2 x 40.6)				6-15P	1
40709-C	FFA8115	Countertop fryer with drain, 15 lb.	1	11 ¹ / ₂ x 19 ³ / ₄ x 16 (29.2 x 50.2 x 40.6)	2630-3500	208-240	12.6 -14.6	6-20P	1
40710-C	FFA8130	Dual countertop fryer with drain, 2 x 15 lb	2	23 x 19 ³ / ₄ x 16 (59.4 x 50.2 x 40.6)	per well		per well	6-20P	1
40710*	FFA8130	Dual countertop fryer with drain, 2 x 15 lb	2	23 x 19 ³ / ₄ x 16 (59.4 x 50.2 x 40.6)				6-15P	1

*Dual unit features two separate power cords and requires two receptacles

Cayenne Fryer Accessories

- See pages 16-17 for french fry prep items



ITEM #	DESCRIPTION	FITS	DIMENSIONS (W X D X H): IN (CM)	CASE LOT
40711	Fryer basket, small	Standard & medium-duty	3 ⁵ / ₁₆ x 9 ⁵ / ₁₆ x 4 ⁵ / ₁₆ (10 x 23 x 12.5)	1
40712	Fryer basket, large	Standard & medium-duty	8 ⁵ / ₁₆ x 9 ⁵ / ₁₆ x 4 ⁵ / ₁₆ (20.5 x 23 x 12.5)	1
40713	Fryer night cover, large baskets	Standard duty	13 x 10 ⁵ / ₁₆ x 5 ⁵ / ₁₆ (33 x 27 x 1.5)	1
40714	Fryer night cover, small baskets	Standard duty	13 x 10 ⁵ / ₁₆ x 5 ⁵ / ₁₆ (33 x 27 x 1.5)	1



SOUS VIDE

THE COMPLETE SOLUTION:
SOUS VIDE AND VACUUM PACKS

watch it on VOLLRATH.com



See Chef Rich demonstrate sous vide cooking.



Sous Vide Immersion Circulators

VOLLRATH GIVES YOU EVERYTHING YOU NEED FOR SOUS VIDE – FROM VACUUM PACKING TO IMMERSION CIRCULATORS TO CHARBROILERS. VOLLRATH’S FULL LINE OF SOUS VIDE COOKING EQUIPMENT GIVES PRECISE, REPEATABLE RESULTS EVERY TIME.

- Precise, repeatable results with no moisture loss
- Occupies minimal counter space and cooks unattended
- Precise cooking method (display will show resolution of 0.1 degree in either °F or °C)



ITEM #	DESCRIPTION	DIMENSIONS (W X D X H): IN (CM)	VOLTAGE	WATTS	AMPS	PLUG	CASE LOT
40868	Sous vide – immersion circulator (head only)	10 x 5 x 12.5 (25.4 x 12.7 x 31.8)	120 AC	1100	11	5-15P	1
40861	Sous vide – immersion circulator head, bath & cover	31 x 14 x 14.5 (78.7 x 35.6 x 36.8)	120 AC	1100	11	5-15P	1

VACUUM PACK MACHINES & BAGS

- Extends the shelf life of foods and cuts down on waste due to spoilage
- Excellent for items like meat and cheese
- Vacuum packing opens the pores in foods, creating an excellent way to quickly marinate meats

See page 25 for product details.





WARMING EQUIPMENT

Keep your business hot and your food warm with our wide selection of rethermalizers. From Induction Buffet Warmers to the Direct Contact Heating System, Vollrath is changing the way the industry holds and serves soups and other hot foods.

[VOLLRATH.com/warming-equip](https://www.vollrath.com/warming-equip)

How to Shop

WARMING EQUIPMENT

Induction Buffet Warmers

Discover a smarter, safer way to serve. With convenient features and a sleek, contemporary design, Induction Buffet Warmers from Vollrath elevate your presentation while keeping food at a precise temperature.



MIRAGE® INDUCTION BUFFET WARMERS

Page 53



MIRAGE DECORATIVE INDUCTION BUFFET WARMERS

Page 54

Induction Soup Warmers & Rethermalizers

Use leading-edge technology to keep your most popular soups and sauces at food-safe temperatures and ready to serve with Induction Soup Warmers and Rethermalizers from Vollrath.



COUNTERTOP RETHERMALIZERS

Pages 55-56

THE INDUSTRY'S MOST COMPLETE LINE OF HOT DROP-IN TECHNOLOGY

With six specially designed hot well solutions, Vollrath features the most extensive range of hot well technology in the industry. So no matter what your serving application calls for, Vollrath can fit your needs with the configuration and fabricator components to keep your food fresh and flavorful.

NEW

REFERENCE OUR SERVING SYSTEMS & COMPONENTS CATALOG OR VOLLRATH.COM FOR OUR FULL LINE OF DROP-IN SOLUTIONS INCLUDING OUR NEW MODULAR INDUCTION DRY HOT WELLS.



Traditional Warmers & Rethermalizers

Add flexibility to your operation with the Cayenne® line of warming and holding equipment.



TRADITIONAL SOUP WARMER AND RETHERMALIZERS

- Retro Stock Pot
- Cayenne Soup Warmers/Rethermalizers
- Cayenne Colonial Kettles™

Page 57-58



CAYENNE FOOD WARMERS & RETHERMALIZERS

Pages 59-63

Additional Warming Equipment

Our heat lamps, heated shelves, and heat strips allow you to customize a space while keeping all your favorites warm.



CAYENNE HEAT LAMPS

Page 64



CAYENNE HEATED SHELVES

Page 64



CAYENNE HEAT STRIPS

Page 65

INDUCTION BUFFET WARMERS



NEW Full-Size Mirage® Induction Buffet Warmers & 16"x16" Induction Buffet Warmers



5950875



5950275



- Fewer cords! Connect up to 3 units together with inter-connect cords
- Subtle, low-profile, attractive design coordinates with any serving setup
- Low wattage to keep food warm during serving
- Tempered black glass top
- Touch control, 4 power settings
- LED indicator lights on control panel and glass
- Non-slip mat keeps chafers/cookware securely in place – order separately



ITEM #	DESCRIPTION	COLOR	DIMENSIONS: (W X D X H): IN (CM)	VOLTAGE AC	WATTS	AMPS	PLUG	CASE LOT
16" X16" INDUCTION BUFFET WARMERS								
5950275	Countertop Induction Warmer	Black	16 x 16 x 3 ¹ / ₁₆ (40.6 x 40.6 x 8)	120	300	2.5	NEMA 5-15P	1
5950280	Countertop Induction Warmer	Natural	16 x 16 x 3 ¹ / ₁₆ (40.6 x 40.6 x 8)	120	300	2.5	NEMA 5-15P	1
59502DW	Drop-In Induction Warmer	N/A	16 x 16 x 3 ¹ / ₁₆ (40.6 x 40.6 x 8)	120	300	2.5	NEMA 5-15P	1
NEW FULL-SIZE BUFFET WARMERS								
5950875	Full-size induction buffet warmer	Black	23 x 16 x 3 ¹ / ₁₆ (58.4 x 40.6 x 7.78)	120	375	3.15	NEMA 5-15P	1
5950880	Full-size induction buffet warmer	Natural	23 x 16 x 3 ¹ / ₁₆ (58.4 x 40.6 x 7.78)	120	375	3.15	NEMA 5-15P	1
59508DW	Drop-in full-size induction buffet warmer	N/A	23 x 16 x 3 ¹ / ₁₆ (58.4 x 40.6 x 7.78)	120	375	3.15	NEMA 5-15P	1



For full-size countertop warmer international models, add suffix to designate version: Schuko (02), UK (03), China (04), Australia (05). Visit VOLLRATH.com to view product specifications.

ITEM #	DESCRIPTION	DIMENSIONS (LxW): IN (CM)	CASE LOT
NON-SLIP MATS			
4644070	Non-slip mat – full-size	16 x 8 (40.6 x 20.3)	1
4644080	Non-slip mat – 2/3 size	9 x 8 (22.9 x 20.3)	1

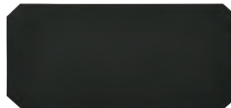

NEW Mirage® Decorative Induction Buffet Warmers

- The same great features as our Mirage Induction Buffet Warmers (see Page 53)
- Decorative glass is durable and adds elegance to any presentation
- Linen and Sunburst glass options available
- Available in Black Countertop, Champagne Countertop, or Drop-In



Sunburst



Linen

- 100-piece minimum order quantity
- Extended design development lead-time required
- Tooling charges apply
- Contact your Vollrath sales representative

Custom Design or Logo



59503SB75



59503LN85



ITEM #	DESCRIPTION	WRAPPER COLOR	DIMENSIONS (W X D X H): IN (CM)	VOLTAGE AC	WATTS	AMPS	PLUG	CASE LOT
59503LN75	Countertop, Linen Glass	Black	16 x 16 x 3 1/8 (40 x 40.6 x 7.8)	120	300	2.5	NEMA 5-15P	1
59503LN85	Countertop, Linen Glass	Champagne	16 x 16 x 3 1/8 (40 x 40.6 x 7.8)	120	300	2.5	NEMA 5-15P	1
59503LNDW	Drop-In, Linen Glass	N/A	16 x 16 x 3 1/8 (40 x 40.6 x 7.8)	120	300	2.5	NEMA 5-15P	1
59503SB75	Countertop, Sunburst Glass	Black	16 x 16 x 3 1/8 (40 x 40.6 x 7.8)	120	300	2.5	NEMA 5-15P	1
59503SB85	Countertop, Sunburst Glass	Champagne	16 x 16 x 3 1/8 (40 x 40.6 x 7.8)	120	300	2.5	NEMA 5-15P	1
59503SBDW	Drop-In, Sunburst Glass	N/A	16 x 16 x 3 1/8 (40 x 40.6 x 7.8)	120	300	2.5	NEMA 5-15P	1



For Decorative Warmer Schuko models, add appropriate suffixes – 59503 + 2-digit pattern suffix (LN for Linen, SB for Sunburst) + 2-digit wrapper suffix (75 for Black, 85 for Champagne, DW for Drop-In) + 2-digit version suffix (02 for Schuko). Example: 59503LN7502 – Decorative Warmer, Linen Glass Pattern, Black Wrapper, Schuko version. Visit VOLLRATH.com to view product specifications.

DROP-IN PRODUCTS



REFERENCE OUR SERVING SYSTEMS & COMPONENTS CATALOG FOR MORE DROP-IN STYLES.



DESIGNED SPECIFICALLY FOR INDUCTION BUFFET WARMERS – MIRAGE® AND INTRIGUE® INDUCTION CHAFERS

- Chafers accept standard-size steam table pans
- Available with mirror finish stainless steel or glass cover
- Automatic slow-close feature keeps food hot
- For use with induction warmers or as traditional chafers in the optional stands
- Stands accept both Universal Chafer Heater (sold separately) or canned fuel

See page 199 for product details.



INDUCTION SOUP WARMERS & RETHERMALIZERS



ELIMINATE WATER, NO FILLING & REFILLING, NO SCALING, NO WATER ON COUNTERS, NO MANIFOLDS OR DRAINS

3-D induction coils act like steam, but without the water

REDUCE ENERGY COSTS WITH LOW AMP DRAW

250W warmers are 120V and 2.1 amps; 800W rethermalizers are 120V and 6.7 amps

EASY AND SECURE TEMPERATURE CONTROL

Precise 1° temperature settings on induction soup rethermalizers

FAST RETHERMALIZING TIMES

Fast, efficient induction takes 50-60 minutes to rethermalize foods vs. 1½ hours in most other units

MAINTAIN CONTROL OVER TEMPERATURE SETTINGS

Unique hold feature locks the temperature in place

KEEP SOUPS PROPERLY STIRRED

Stir indicator measures temperature differences and reminds operators to stir

EASY TO USE

Bright LED display with easy-to-use controls

IMMEDIATE START-UP, NO PRE-HEATING

Induction heats the inset directly without a steam bath, which requires a pre-heat

INCREASE FOOD YIELD, MINIMIZE FOOD WASTE

Sensors prevent food from burning in near-empty insets

REFERENCE OUR SERVING SYSTEMS & COMPONENTS CATALOG FOR DROP-IN STYLES.

watch it on VOLLRATH.com/retherm



Watch a video presentation about the award-winning features of the Mirage® Soup Induction Rethermalizer.

CERTIFICATIONS



*International models only

AWARDS



NACUFS IICE INDUSTRY INNOVATION AND CREATIVE EXCELLENCE AWARD

Countertop Rethermalizers

- Ships with induction-ready inset and hinged cover
- Set temperature in F° or C° for soup, cream soup, mac & cheese, or chili
- **REFERENCE OUR SERVING SYSTEMS & COMPONENTS CATALOG FOR DROP-IN STYLES**



NACUFS IICE INDUSTRY
INNOVATION AND CREATIVE
EXCELLENCE AWARD

ITEM #	DESCRIPTION	COLOR	DIMENSIONS IN (CM)	FREQUENCY	VOLTAGE	WATTS	AMPS	PLUG	CASE LOT
7470110	7 qt induction rethermalizer	Silver	11½ x 13½ (30.3 x 34.2)	50/60Hz	120	800	6.7	5-15P	1
7470140	7 qt induction rethermalizer	Red	11½ x 13½ (30.3 x 34.2)	50/60Hz	120	800	6.7	5-15P	1
74110110	11 qt induction rethermalizer	Silver	13¾ x 13½ (35.3 x 34.2)	50/60Hz	120	800	6.7	5-15P	1
74110140	11 qt induction rethermalizer	Red	13¾ x 13½ (35.3 x 34.2)	50/60Hz	120	800	6.7	5-15P	1

REPLACEMENT INSET ITEM #	REPLACEMENT INSET	REPLACEMENT COVERS	DESCRIPTION
88184	7 qt induction inset	47488	Hinged inset cover, fits 7 qt inset
88204	11 qt induction inset	47490	Hinged inset cover, fits 11 qt inset
88184NS*	7¼ qt nonstick induction inset	88184NS*	7¼ qt nonstick induction inset
88204NS*	11 qt nonstick induction inset	88204NS*	11 qt nonstick induction inset

*Nonstick insets are made to order; call Vollrath for minimums and lead time.



For 7 quart International models with 220-240V, change the fifth digit to "2" for Schuko, "3" for UK, "4" for China, or "5" for Australia (e.g., Schuko 7470110 to 7470210)
For 11 quart International models with 220-240V, change the sixth digit to "2" for Schuko, "3" for UK, "4" for China, or "5" for Australia (e.g., Schuko 74110110 to 74110210)

NEW Contemporary Hinged Inset Lids

IMPROVED INSET COVER DESIGN

- Welded handle is permanently attached and stays secured to cover
- Handle serves as kickstand, keeping cover open for easy access to food
- No friction-fit tabs to lose
- Design of handle dissipates heat, keeping it cooler to the touch
- Fits most 7-quart and 11-quart insets
- Large opening for easy access



ITEM #	DESCRIPTION	OVERALL DIAMETER: IN (CM)	HEIGHT: IN (CM)	CASE LOT
47493	Hinged inset lid – 7¼ qt	9½ (25.3)	2¾ (7)	1
47494	Hinged inset lid – 11 qt	11½ (30)	2¾ (7)	1

DROP-IN PRODUCTS



REFERENCE OUR
SERVING SYSTEMS
& COMPONENTS
CATALOG FOR
DROP-IN STYLES.



KOOL-TOUCH® LADLES WITH HIGH TEMPERATURE JUST GOT COOLER

- Kool-Touch® Handles are color safe up to 225°F (107.2°C)
- Fully functional to 350°F (176.6°C)
- Insulated coating permanently bonded to utensil – will not slip or peel
- Provides cool, comfortable grip

See page 143-144 for product details.



TRADITIONAL WARMER & RETHERMALIZER GUIDE



THE MOST EFFICIENT HEAT TRANSFER POSSIBLE

Vollrath's Direct Contact Heating System. No Vents = Energy Savings



With a heating element in direct contact with the water and Vollrath's exclusive thermostet fiber-reinforced resin well, so little heat is lost that there is no need for vents.



Warmers & Rethermalizers

- Industry's most complete lineup of warmers and rethermalizers
- Feature Direct Contact Heating System
- Warmers keep hot food hot
- Rethermalizers take prepared food from chilled to hot

Visit VOLLRATH.com for more about the ultimate performance and efficiency of Vollrath's Direct Contact Heating System.



ITEM #	WELL CONFIGURATION (W X D)	WATTAGE	WARMER ONLY	WARMER AND RETHERMALIZER	DIRECT CONTACT HEATING SYSTEM	STAINLESS STEEL WELL	LOW WATER LIGHT	THERMOSTATICALLY CONTROLLED	DRIPLESS EDGE	LIGHTED ON/OFF SWITCH	DRAIN	OFFERED WITH INSETS AND LADLES	PAGE # SHOWN
71001 Traditional Warmer	12 x 20	700	✓	—	✓	—	✓	✓	✓	—	—	—	63
72000 Traditional Warmer	12 x 20	1000	✓	—	—	✓	—	✓	—	—	—	—	63
72020 Rethermalizer	12 x 20	1000	—	✓	✓	—	✓	✓	✓	✓	—	—	61
72023 Rethermalizer	12 x 20	1440	—	✓	✓	—	✓	✓	✓	✓	—	—	61
72090 Rethermalizer	12 x 20	1440	—	✓	—	✓	—	✓	—	✓	—	—	62
72017 Round Rethermalizer	7 qt. Round	800	—	✓	✓	—	✓	✓	✓	—	—	✓	58
72021 Round Rethermalizer	11 qt. Round	800	—	✓	✓	—	✓	✓	✓	—	—	✓	58
72050 1/3 Rect. Rethermalizer	1/3 Rectangular	1600	—	✓	✓	—	✓	✓	✓	✓	—	—	61
72051 1/3 Rect. Rethermalizer	1/3 Rectangular	1600	—	✓	✓	—	✓	✓	✓	✓	✓	—	61
72789 Dual Warmer	Dual, 12 x 20	1400	✓	—	✓	—	✓	✓	✓	✓	✓	—	62
72045 Rethermalizer	Twin 4 qt. Round	550/ea.	—	✓	—	**	—	✓	—	—	—	✓	59
72028 Rethermalizer	Twin 7 qt. Round	700/ea.	—	✓	✓	—	✓	✓	✓	—	—	✓	59
72425 Round Rethermalizer	4 qt. Round	350	✓	—	—	**	—	✓	—	—	—	✓	62
Colonial Kettle™ Warmer	11 qt. Round	650	✓	—	✓	**	—	✓	✓	—	—	✓	60
Colonial Kettle™ Rethermalizer	11 qt. Round	900	—	✓	✓	**	—	✓	✓	—	—	✓	60
Induction Rethermalizer	7 or 11 qt. Round	800	—	✓	—	✓	—	✓	✓	✓	—	Inset only	56
Retro Stock Pot Rethermalizer	7 or 11 qt. Round	1450	—	✓	—	✓	—	—	✓	✓	—	Inset only	58

**Coated aluminum

Retro Stock Pot Kettle Rethermalizers

- Eye-catching look enhances your soup presentation
- Heavy-duty handles make transportation and cleaning a breeze
- Ceramic base element ensures a fast start-up and consistent performance
- Heavy-duty exterior ensures the unit remains cool to the touch
- Offset handle on the hinged lid keeps the customer's hands/arms out of the direct heat path
- Ladles sold separately



7217255
Cover shown not NSF certified



ITEM #	DESCRIPTION	COLOR		DIMENSIONS (W X D X H): IN (CM)	VOLTAGE	WATTS	AMPS	PLUG	CASE LOT
7217710	7 qt Natural finish	Natural		16½ x 13½ (41.9 x 34.3)	120	1450	12	5-15P	1
7217735	7 qt Green Apple finish	Green		16½ x 13½ (41.9 x 34.3)	120	1450	12	5-15P	1
7217750	7 qt Pearl White finish	White		16½ x 13½ (41.9 x 34.3)	120	1450	12	5-15P	1
7217755	7 qt Fire Engine Red finish	Red		16½ x 13½ (41.9 x 34.3)	120	1450	12	5-15P	1
7217760	7 qt Black Black finish	Black		16½ x 13½ (41.9 x 34.3)	120	1450	12	5-15P	1
7217210	11 qt Natural finish	Natural		16½ x 13½ (41.9 x 34.3)	120	1450	12	5-15P	1
7217235	11 qt Green Apple finish	Green		16½ x 13½ (41.9 x 34.3)	120	1450	12	5-15P	1
7217250	11 qt Pearl White finish	White		16½ x 13½ (41.9 x 34.3)	120	1450	12	5-15P	1
7217255	11 qt Fire Engine Red finish	Red		16½ x 13½ (41.9 x 34.3)	120	1450	12	5-15P	1
7217260	11 qt Black Black finish	Black		16½ x 13½ (41.9 x 34.3)	120	1450	12	5-15P	1
46527	Replacement hinged lid—fits insets: 78204, 78194, 46311-2, 46407-2				—	—	—	—	6



- For 7 quart International models with 220-240V, change the fifth digit to "8" for Schuko or "9" for UK (e.g., Schuko 7470710 to 7470810)
 - For 11 quart International models with 220-240V, change the sixth digit to "3" for Schuko or "4" for UK (e.g., Schuko 74110110 to 74110310)
 - Product details vary (e.g., voltage, amps, watts); visit VOLLRATH.com.

*International models only

Cayenne® Round Heat 'N Serve Rethermalizers

- Features Vollrath's Direct Contact Heating System for energy efficiency and cool-to-touch exterior
- Low water indicator light eliminates guess work



*International models only

ITEM #	DESCRIPTION	DIMENSIONS (DIAMETER X HEIGHT): IN (CM)	WELL DEPTH IN (CM)	VOLTAGE	WATTS	AMPS	PLUG	CASE LOT
72017	Model HS-7, 7 qt (6.6 L) unit only	10% ⁵ x 9% ⁵ (26.8 x 24.5)	6¾ (17.1)	120 AC	800	6.7	5-15P	1
72018	Model HS-7, 7 qt (6.6 L) package with inset (78184), hinged Kool-Touch® cover (47488)*	10% ⁵ x 9% ⁵ (26.8 x 24.5)	6¾ (17.1)	120 AC	800	6.7	5-15P	1
72021	Model HS-11, 11 qt (10.4 L) unit only	12% ⁵ x 9% ⁵ (32.0 x 24.5)	6¾ (17.1)	120 AC	800	6.7	5-15P	1
72009	Model HS-11, 11 qt (10.4 L) package with inset (78204), hinged Kool-Touch® cover (47490)*	12% ⁵ x 9% ⁵ (32.0 x 24.5)	6¾ (17.1)	120 AC	800	6.7	5-15P	1
INTERNATIONAL MODEL								
72517	Model HS-7, 7 qt (6.6 L) unit only	10% ⁵ x 9% ⁵ (26.8 x 24.5)	6¾ (17.1)	230 AC	800	3.5	Schuko	1
72518	Model HS-7, 7 qt (6.6 L) package with inset (78184), hinged Kool-Touch® cover (47488)*	10% ⁵ x 9% ⁵ (26.8 x 24.5)	6¾ (17.1)	230 AC	800	3.5	Schuko	1
72521	Model HS-11, 11 qt (10.4 L) unit only	12% ⁵ x 9% ⁵ (32.0 x 24.5)	6¾ (17.1)	230 AC	800	3.5	Schuko	1
72522	Model HS-11, 11 qt (10.4 L) package with inset (78204), hinged Kool-Touch® cover (47490)*	12% ⁵ x 9% ⁵ (32.0 x 24.5)	6¾ (17.1)	230 AC	800	3.5	Schuko	1
72196	Adaptor ring — allows use of 7 qt inset with 11 qt Heat 'N Serve	—	—	—	—	—	—	1
72221	Adaptor ring — allows use of 4 qt inset with 7 qt Heat 'N Serve	—	—	—	—	—	—	1

*Hinged covers are not NSF® certified.

Cayenne® Model CM-24 Twin Well 4 Qt Rethermalizer

- Features Vollrath's Direct Contact Heating System for energy efficiency and cool-to-touch exterior
- Individual thermostatic controls for merchandising soups with different temperature requirements
- Holds two 4½ qt insets (Inset item #78164)



72040

ITEM #	DESCRIPTION	MAXIMUM DIMENSIONS (W X D X H): IN (CM)	VOLTAGE	WATTS	AMPS	PLUG	CASE LOT
72045	Twin well 4 qt rethermalizer	17¼ x 9¼ x 8¾ (43.8 x 23.5 x 22.2)	120 AC	550 per well	9.2	5-15P	1
72040	Twin well 4 qt rethermalizer, package with two insets (78164) and two hinged covers (47486)*	17¼ x 9¼ x 12¼ (43.8 x 23.5 x 31.1)	120 AC	550 per well	9.2	5-15P	1

Cayenne Model TW-27R Twin Well 7 Quart Rethermalizer



72028

- Features Vollrath's Direct Contact Heating System for energy efficiency and cool-to-touch exterior
- Designed to provide optimum serving temperature for two different food products
- Individual thermostatic controls and rethermalizing timer for optimal control of each well
- Low water indicator light eliminates guesswork



Convert to 4 qt with 72221 Adaptor Rings. (Rings, insets, and covers sold separately.)



ITEM #	DESCRIPTION	MAXIMUM DIMENSIONS (W X D X H): IN (CM)	VOLTAGE	WATTS	AMPS	PLUG	CASE LOT
72028	Model TW-27R twin well 7 qt rethermalizer	13½ x 23 x 11½ (34.3 x 58.4 x 29.2)	120 AC	700 per well	11.7	5-15P	1
72029	Model TW-27R twin well 7 qt rethermalizer package with (2) 7¼ qt insets (78184), (2) hinged Kool-Touch® covers (47488),* and (2) 4 oz heavy-duty ladles (4980420)	13½ x 23 x 11½ (34.3 x 58.4 x 29.2)	120 AC	700 per well	11.7	5-15P	1
72221	Adaptor ring – allows use of 4 qt inset (78164) with 7 qt twin well merchandiser		—	—	—	—	2

*Hinged covers are not NSF® certified.

KOOL-TOUCH® LADLES

- Kool-Touch® Handles are color safe up to 225°F (107.2°C)
- Fully functional to 350°F (176.6°C)
- Insulated coating permanently bonded to utensil – will not slip or peel
- Provides cool, comfortable grip

See page 143-144 for product details.



Cayenne® Colonial Kettles™

- Designed to increase soup sales at any location
- Durable-cast four-leg design is more stable
- Low profile allows easy access
- Epoxy-coated cast aluminum body
- Recessed controls prevent accidental temperature setting changes
- Uses shouldered inset pans that are easier and safer to transport than bain maries
- Note: Hinged Kool-Touch® cover is not NSF® certified
- Easily convert 11 qt to 7 qt with an adaptor ring – see accessory item 72196 on page 58



Go to VOLLRATH.com for replacement Cayenne® Colonial Kettle™ parts.



*International models only



ITEM #	DESCRIPTION	DIMENSIONS (DIAMETER X H): IN (CM)	VOLTAGE	WATTS	AMPS	PLUG	CASE LOT
MODEL 1776-11 COLONIAL KETTLE™ 11 QT WARMER PACKAGE WITH 11 QT (10.4 L) INSET, COVER WITH HINGE, SOUP CARDS, AND SOUP'R CLIP							
72165	Black warmer	15¾ x 11½ (40.0 x 29.2)	120 AC	700	5.8	5-15P	1
72166	Burnt Copper warmer	15¾ x 11½ (40.0 x 29.2)	120 AC	700	5.8	5-15P	1
MODEL 1776-7 COLONIAL KETTLE™ 7 QT WARMER PACKAGE WITH 7 QT (6.6 L) INSET, COVER WITH HINGE, ADAPTOR RING, SOUP CARDS, AND SOUP'R CLIP							
72170	Black warmer	15¾ x 11½ (40.0 x 29.2)	120 AC	700	5.8	5-15P	1
72171	Burnt Copper warmer	15¾ x 11½ (40.0 x 29.2)	120 AC	700	5.8	5-15P	1
MODEL 1777-11 COLONIAL KETTLE™ 11 QT RETHERMALIZER PACKAGE WITH 11 QT (10.4 L) INSET, COVER WITH HINGE, SOUP CARDS, AND SOUP'R CLIP							
72175	Black rethermalizer	15¾ x 11½ (40.0 x 29.2)	120 AC	1000	8.3	5-15P	1
72176	Burnt Copper rethermalizer	15¾ x 11½ (40.0 x 29.2)	120 AC	1000	8.3	5-15P	1
MODEL 1777-7 COLONIAL KETTLE™ 7 QT RETHERMALIZER PACKAGE WITH 7 QT (6.6 L) INSET, COVER WITH HINGE, SOUP CARDS, AND SOUP'R CLIP							
72180	Black rethermalizer	15¾ x 11½ (40.0 x 29.2)	120 AC	1000	8.3	5-15P	1
72181	Burnt Copper rethermalizer	15¾ x 11½ (40.0 x 29.2)	120 AC	1000	8.3	5-15P	1
INTERNATIONAL MODEL							
MODEL 1776-11 COLONIAL KETTLE™ 11 QT WARMER PACKAGE WITH 11 QT (10.4 L) INSET, COVER WITH HINGE, SOUP CARDS, AND SOUP'R CLIP							
72459	Black warmer	15¾ x 11½ (40.0 X 29.2)	230 AC	600	2.6	Schuko	1
72542	Black warmer	15¾ x 11½ (40.0 X 29.2)	230 AC	600	2.6	UK	1
MODEL 1777-11 COLONIAL KETTLE™ 11 QT RETHERMALIZER PACKAGE WITH 11 QT (10.4 L) INSET, COVER WITH HINGE, SOUP CARDS, AND SOUP'R CLIP							
72462	Black rethermalizer	15¾ x 11½ (40.0 X 29.2)	230 AC	900	4.0	Schuko	1

CONTEMPORARY HINGED INSET LIDS

- Welded handle is permanently attached and stays secured to cover
- Handle serves as kickstand, keeping cover open for easy access to food
- No friction-fit tabs to lose
- Design of handle dissipates heat, keeping it cooler to the touch
- Fits most 7-quart and 11-quart insets
- Large opening for easy access

See page 99 for product details.



Cayenne® Full-Size Heat 'N Serve Rethermalizers

- Features Vollrath's Direct Contact Heating System for energy efficiency and cool-to-touch exterior
- Lighted on/off switch and recessed control knobs
- Recommend using up to 4" (10.2 cm) deep food pans
- 1440-watt Ultra model offers quicker preheat and more rapid rethermalization



72020/72023



*International models only

ITEM #	DESCRIPTION	DIMENSIONS (W X D X H): IN (CM)	WELL DEPTH IN (CM)	VOLTAGE	WATTS	AMPS	PLUG	CASE LOT
72020	Model 1220 full-size rethermalizer	21¾ x 13¾ x 9 (55 x 33 x 23)	6½ (16.8)	120 AC	1000	8.3	5-15P	1
72023	Model HS-Ultra full-size rethermalizer	21¾ x 13¾ x 9 (55 x 33 x 23)	6½ (16.8)	120 AC	1440	12	5-15P	1
INTERNATIONAL MODEL								
72630	Model 1220 full-size rethermalizer	21¾ x 13¾ x 9 (55 x 33 x 23)	6½ (16.8)	230 AC	1000	4.3	Schuko	1
72550	Model 1220 full-size rethermalizer	21¾ x 13¾ x 9 (55 x 33 x 23)	6½ (16.8)	230 AC	1000	4.3	UK	1

Cayenne® Heat 'N Serve 4/3 Rectangular Rethermalizer

- Designed for maximum capacity within a minimum footprint
- Features Vollrath's Direct Contact Heating System for energy efficiency and cool-to-touch exterior
- 33% greater capacity than full-size warmers — holds four ⅓ size pans up to 6" (15.2 cm) deep
- Two 800-watt elements for rethermalization and faster recovery
- Capillary tube thermostat for more accurate temperature control



72788

72050



ITEM #	DESCRIPTION	MAXIMUM DIMENSIONS (W X D X H): IN (CM)	VOLTAGE	WATTS	AMPS	PLUG	CASE LOT
72050	Model T43R without drain	13¾ x 28¾ x 9¾ (34.9 x 73 x 24.8)	120 AC	1600	13.3	5-15P	1
72051	Model TD43R with drain	13¾ x 28¾ x 13¾ (34.9 x 73 x 33.7)	120 AC	1600	13.3	5-15P	1
72788	Model T43R without drain package with (3) hole adaptor plates (19188), (3) stainless steel insets (78184), (3) hinged Kool-Touch® inset covers (47488)*, and (3) one-piece heavy-duty black ladles (4980420)	13¾ x 28¾ x 9¾ (34.9 x 73 x 24.8)	120 AC	1600	13.3	5-15P	1
CANADA MODEL – AVAILABLE FOR CANADA ONLY							
72055	Model T43R without drain	13¾ x 28¾ x 9¾ (34.9 x 73 x 24.8)	120 AC	1600	13.3	5-20P	1
72056	Model TD43R with drain	13¾ x 28¾ x 13¾ (34.9 x 73 x 33.7)	120 AC	1600	13.3	5-20P	1
19188	Adaptor plate with three 8¾" (21.3 cm) diameter holes for 7¼ qt round insets (inset item #78184)		—	—	—	—	1
75012	Adaptor bars, 1" x 12 ¹⁵ / ₁₆ " x ¼" (2.5 x 32.9 x 0.6 cm)		—	—	—	—	12

*Hinged covers are not NSF® certified.

Cayenne® Nitro™ Power Rethermalizer

- Almost twice the water capacity of other countertop models, reducing need to refill the well as often
- Heating element in direct contact with the water
- High-efficiency 1440W element operates on standard 15A circuit



ITEM #	DESCRIPTION	DIMENSIONS (W X D X H): IN (CM)	VOLTAGE	WATTS	AMPS	PLUG	CASE LOT
72090	Model PC-21, rethermalizer	14 x 22 x 9½ (35.6 x 55.9 x 24.1)	120 AC	1440	12.0	5-15P	1

Cayenne Model SS-4 Warmer

- Holds 4½ quart (3.9 L) insets
- Sized for #10 cans and pump for dispensing hot fudge or toppings
- Ideal for ice cream toppings and nacho cheese sauce



72425

ITEM #	DESCRIPTION	MAXIMUM DIMENSIONS (DIAMETER X H): IN (CM)	PLUG	CASE LOT
72425	Warmer only	8¾ x 7¾ (22.2 x 20)	5-15P	1
72430	Warmer and inset (78164) and hinged Kool-Touch® cover (47486)*	—	5-15P	1

*Hinged covers are not NSF® certified.

Cayenne Dual Warmer

- Two independently controlled warmers featuring Vollrath's exclusive Direct Contact Heating System for energy efficiency and cool-to-touch exterior
- Drain hose and controls are concealed behind front panel for easy access and a finished look for front-of-house applications
- Lighted main power switch controls power to both wells



72789

72789 with templates & insets (not included)



ITEM #	DESCRIPTION	MAXIMUM DIMENSIONS (W X D X H): IN (CM)	VOLTAGE	WATTS	AMPS	PLUG	CASE LOT
72789	Dual warmer	30½ x 24½ x 12½ (77.5 x 61 x 31.8)	120 AC	1400	11.6	5-15P	1

Cayenne® Model 1001 Warmer

- Features Vollrath's Direct Contact Heating System for energy efficiency and cool-to-touch exterior
- Thermostatic control supplies power only when needed for maximum efficiency
- Low water indicator light eliminates guesswork
- Recommend using up to 4" (10.2 cm) deep food pans



*International models only

ITEM #	DESCRIPTION	DIMENSIONS (W X D X H): IN (CM)	VOLTAGE	WATTS	AMPS	PLUG	CASE LOT
71001	Model 1001 full-size warmer only	13¾ x 21¾ x 9 (35.6 x 55.9 x 22.8)	120 AC	700	5.8	5-15P	1
INTERNATIONAL MODEL							
72620	Model 1001 full-size warmer only	13¾ x 21¾ x 9 (35.6 x 55.9 x 22.8)	230 AC	700	3.0	Schuko	1
72553	Model 1001 full-size warmer only	13¾ x 21¾ x 9 (35.6 x 55.9 x 22.8)	230 AC	700	3.0	UK	1

Cayenne® Model 2000 Warmer

- 300 series stainless steel 6½" (16.6 cm) deep well for easy cleaning and longer life
- Recommend using up to 4" (10.2 cm) deep food pans
- Recommend using moist heat



*International models only

ITEM #	DESCRIPTION	DIMENSIONS (W X D X H): IN (CM)	VOLTAGE	WATTS	AMPS	PLUG	CASE LOT
72000	Cayenne® Model 2000 Warmer only	14 x 22 x 9 (35.6 x 55.9 x 22.8)	120 AC	1000	8.3	5-15P	1
INTERNATIONAL MODEL							
72557	Cayenne® Model 2000 Warmer only	14 x 22 x 9 (35.6 x 55.9 x 22.8)	230 AC	1000	4.3	Schuko	1

SERVING SYSTEMS & COMPONENTS

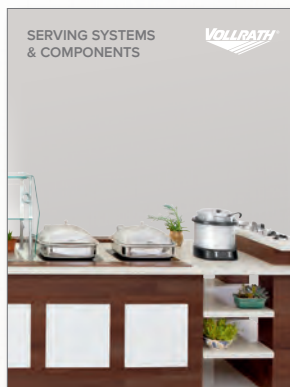

CAYENNE® DROP-IN WARMER

- Thermoset Fiber-Reinforced Resin Well – self-insulating for maximum energy efficiency
- 6-foot cord and plug or hard wired
- Top mounts
- Low water indicator light eliminates guesswork
- Drain models allow for easy cleaning
- Recommend using up to 4" (10.2 cm) deep pans – full and fractional sizes

REFERENCE OUR SERVING SYSTEMS & COMPONENTS CATALOG FOR DROP-IN STYLES.



ADDITIONAL WARMING EQUIPMENT



Cayenne® OHC-500 Heat Lamp

- Adjustable-height lamp assembly 12½" to 20½" (31.8 to 52 cm) above counter
- Stainless steel hood directs heat evenly over 12" x 20" area
- Chrome-plated legs and uprights
- Cord-mounted on/off switch
- Shatterproof white bulbs standard
- Non-skid feet
- 120V, 500W, 4.2A



Shown with optional full-size pan sold separately

ITEM #	DESCRIPTION	MAXIMUM DIMENSIONS (W X D X H): IN (CM)	PLUG	CASE LOT
71500	OHC-500 heat lamp – white bulbs	14 x 19 x 28¾ (35.6 x 48.3 x 73)	5-15P	1
72500	OHC-500 heat lamp – red bulbs	14 x 19 x 28¾ (35.6 x 48.3 x 73)	5-15P	1
ACCESSORIES				
72242	White infrared bulb, 250W, 120V	—	—	12
72241	Red infrared bulb, 250W, 120V	—	—	12

Cayenne® Heated Shelves

- 33% to 66% energy savings during off-peak times by heating only the zone that is needed
- Thermostatically controlled unit maintains even and accurate temperature
- Smooth top with welded corners provides an easy-to-clean surface free from grease and dirt traps

Learn how to expand your menu by combining the Cayenne® rotisserie oven with a Cayenne® hot food merchandiser at VOLLRATH.com.

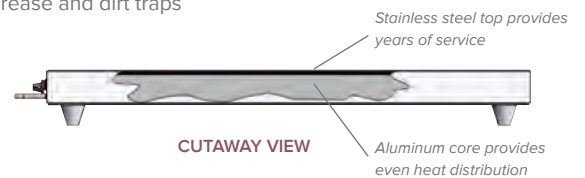

LEFT ALIGNED ITEM #*	RIGHT ALIGNED ITEM #**	WIDTH IN (CM)	DEPTH IN (CM)	VOLTAGE	WATTS	AMPS	PLUG	CASE LOT
7277024*	7277124**	24 (61)	20 (50.8)	120 AC	350	2.9	5-15	1
7277036*	7277136**	36 (91.4)	20 (50.8)	120 AC	535	4.5	5-15	1
7277048*	7277148**	48 (121.9)	20 (50.8)	120 AC	720	6.0	5-15	1
7277060*	7277160**	60 (152.4)	20 (50.8)	120 AC	905	7.5	5-15	1

*Stocked items
**5-day lead time

Note: 48" and 60" models have taller legs.

Cayenne® Heat Strips

- 33% larger "Food Safe Zone"
- Unique heating design offers even heat dispersion for more effective warming
- Fixed or remote controls allow installation flexibility for your operation – available with infinite or toggle switch
- Anodized aluminum heat reflector generates more even heat over food holding area
- Patented reflector assembly is field adjustable, allowing operator to direct heat pattern where needed



Go to VOLLRATH.com/heatstrips for 10 reasons to buy a Cayenne Heat Strip.



Mounting Option: 13" Stainless Steel C Legs shown. Hardwired options available.

ITEM #	DESCRIPTION	WIDTH: IN (CM)	WATTS	PLUG	CASE LOT
72672019	Front-mount toggle switch control with cord and plug	18 (47.7)	415	5-15P	1
72675019	Front-mount toggle switch control with cord and plug	24 (61)	550	5-15P	1
72678019	Front-mount toggle switch control with cord and plug	30 (76.2)	690	5-15P	1
72681019	Front-mount toggle switch control with cord and plug	36 (91.4)	825	5-15P	1
72684019	Front-mount toggle switch control with cord and plug	42 (106.6)	965	5-15P	1
72687019	Front-mount toggle switch control with cord and plug	48 (121.9)	1100	5-15P	1
72693019	Front-mount toggle switch control with cord and plug	60 (152.4)	1380	5-20P	1
72705019*	Hard-wired front-mount wiring box with toggle switch	24 (61)	550	—	1
72711019*	Hard-wired front-mount wiring box with toggle switch	36 (91.4)	825	—	1
72717019*	Hard-wired front-mount wiring box with toggle switch	48 (121.9)	1100	—	1
72723019*	Hard-wired front-mount wiring box with toggle switch	60 (152.4)	1380	—	1
72729019*	Hard-wired front-mount wiring box with toggle switch	72 (182.9)	1660	—	1
72705017*	Hard-wired, remote infinite control – 10A	24 (61)	550	—	1
72711017*	Hard-wired, remote infinite control – 10A	36 (91.4)	825	—	1
72717017*	Hard-wired, remote infinite control – 10A	48 (121.9)	1100	—	1
72723017*	Hard-wired, remote infinite control – 10.1A to 20A	60 (152.4)	1380	—	1
72729017*	Hard-wired, remote infinite control – 10.1A to 20A	72 (182.9)	1660	—	1
4450613	C-leg stand, 13" (33 cm) (for cord and plug only)	—	—	—	1

All heat strips are custom ordered and therefore cannot be canceled or returned per Vollrath terms and conditions.

FIELD-ADJUSTABLE REFLECTOR ASSEMBLY

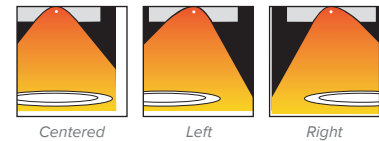

SERVING SYSTEMS & COMPONENTS

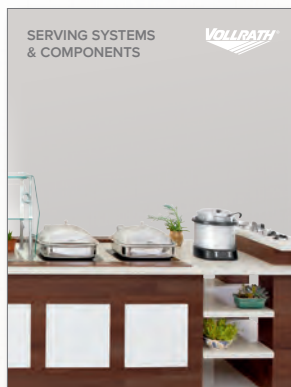

FABRICATOR HEAT AND LIGHT STRIPS

- Keep meals looking and tasting their best. Warm and illuminate your food with the flexibility and functionality of Vollrath heat and light strips.

REFERENCE OUR SERVING SYSTEMS & COMPONENTS CATALOG OR VOLLRATH.COM FOR OUR FABRICATED HEAT AND LIGHT STRIP LINE.

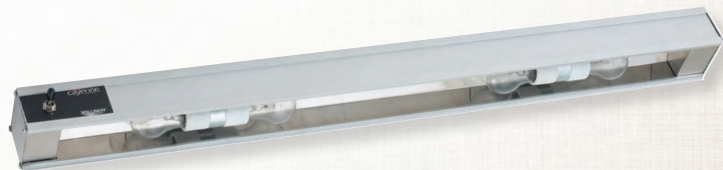



MERCHANDISING & DISPLAY SOLUTIONS

Tempt your customers at meal and snack time with attractive, well-designed display cases and merchandisers.

How to Shop

MERCHANDISING & DISPLAY SOLUTIONS

HEAT UP YOUR CONVENIENCE STORE BUSINESS WITH AN \$11.8 BILLION FOODSERVICE OPPORTUNITY.

The average American now eats at restaurants only 74 times a year – the lowest number in more than 30 years. Yet Americans aren't cooking at home more. Instead, they're eating more prepared and packaged foods.¹ That's why foodservice has become the hottest trend in convenience stores.



Powered Display Cases & Cabinets

From self-service to drop-in, well-merchandised food sells better. Give your foods the attention they deserve while keeping them at the right temperature with our display cases and cabinets. They feature digitally controlled thermostats and dual fans to ensure even temperature control.

Pages 68-70



Acrylic Display Cases

Tempt your customers with fresh pastries and more using our durable and versatile acrylic and cubic countertop display cases.

Pages 71-73



Soup Warming & Merchandising

Make selling soup easier with built-in merchandising signs. They're a great way to free up counter space, so you have room to feature more food options.

Pages 74-75



CUBIC ACRYLIC CASES

Pages 71



HD ACRYLIC CASES

Pages 72



STANDARD ACRYLIC CASES

Page 73

1. Ferdman, Roberto A. Americans Are Falling Out of Love with Restaurants – In 3 Charts. The Washington Post. November 12, 2014. <https://www.washingtonpost.com/news/wonk/wp/2014/11/12/americans-are-falling-out-of-love-with-restaurants-in-3-charts/>

DISPLAY CASES & CABINETS

INNOVATIVE GRAB & GO DISPLAY CASES

- Digitally controlled thermostat on heated units for precise and consistent settings
- Dual fans circulate air throughout unit to ensure even temperature control
- New LED located both at the top of the cabinet and underneath the upper shelf creates optimum food display throughout cabinet
- Double-glaze front for added strength and insulation
- Lift-and-remove rear sliding doors for easy display change and cleaning
- Refrigerated units: 36° to 46°F (2° to 8°C)
- Heated units: 104° to 158°F (40° to 70°C)

Countertop Curved Glass Display Cases



40856

ITEM #	MODEL #	DESCRIPTION	DIMENSIONS (W X D X H): IN (CM)	HP	VOLTAGE	AMPS	WATTS	PLUG
40852	RDE8136	36" curved glass, refrigerated	35½ x 21¼ x 31 (89.9 x 53.8 x 78.7)	¼	120 AC	3.6	—	5-15P
40853	RDE8148	48" curved glass, refrigerated	47¼ x 21¼ x 31 (119.9 x 53.8 x 78.7)	¼	120 AC	4.6	—	5-15P
40854	RDE8160	60" curved glass, refrigerated	59 x 21¼ x 31 (149.9 x 53.8 x 78.7)	¼	120 AC	4.9	—	5-15P
40855	HDE8136	36" curved glass, heated	35½ x 21¼ x 31 (89.9 x 53.8 x 78.7)	—	120 AC	5.6	670	5-15P
40856	HDE8148	48" curved glass, heated	47¼ x 21¼ x 31 (119.9 x 53.8 x 78.7)	—	120 AC	5.9	710	5-15P
40857	HDE8160	60" curved glass, heated	59 x 21¼ x 31 (149.9 x 53.8 x 78.7)	—	120 AC	6.3	750	5-15P

Countertop Cubed Glass Display Cases



40862

ITEM #	MODEL #	DESCRIPTION	DIMENSIONS (W X D X H): IN (CM)	HP	VOLTAGE	AMPS	WATTS	PLUG
40862	RDE8236	36" cubed glass, refrigerated	35½ x 21¼ x 37 (89.9 x 53.8 x 94)	¼	120 AC	3.9	—	5-15P
40863	RDE8248	48" cubed glass, refrigerated	47¼ x 21¼ x 37 (119.9 x 53.8 x 94)	¾	120 AC	5	—	5-15P
40864	RDE8260	60" cubed glass, refrigerated	59 x 21¼ x 37 (149.9 x 53.8 x 94)	¾	120 AC	6	—	5-15P
40865	HDE8236	36" cubed glass, heated	35½ x 21¼ x 37 (89.9 x 53.8 x 94)	—	120 AC	6.1	730	5-15P
40866	HDE8248	48" cubed glass, heated	47¼ x 21¼ x 37 (119.9 x 53.8 x 94)	—	120 AC	6.6	790	5-15P
40867	HDE8260	60" cubed glass, heated	59 x 21¼ x 37 (149.9 x 53.8 x 94)	—	120 AC	7.1	850	5-15P

Note: these items must be shipped by truck

Self-Serve Countertop Curved Glass Display Cases



40881

ITEM #	MODEL #	DESCRIPTION	DIMENSIONS (W X D X H): IN (CM)	HP	VOLTAGE	AMPS	PLUG
40880	RDE8336	36" curved glass, refrigerated	35½ x 21¼ x 31 (89.9 x 53.8 x 78.7)	½	120 AC	4.2	5-15P
40881	RDE8348	48" curved glass, refrigerated	47¼ x 21¼ x 31 (120 x 53.8 x 78.7)	¼	120 AC	7.4	5-15P
40882	RDE8360	60" curved glass, refrigerated	59 x 21¼ x 31 (149.9 x 53.8 x 78.7)	¼	120 AC	8.1	5-15P

Self-Serve Countertop Cubed Glass Display Cases



40886

ITEM #	MODEL #	DESCRIPTION	DIMENSIONS (W X D X H): IN (CM)	HP	VOLTAGE	AMPS	PLUG
40886	RDE8436	36" cubed glass, refrigerated	35½ x 21¼ x 37 (89.9 x 53.8 x 94)	¼	120 AC	4.2	5-15P
40887	RDE8448	48" cubed glass, refrigerated	47¼ x 21¼ x 37 (120 x 53.8 x 94)	¾	120 AC	7.5	5-15P
40889	RDE8460	60" cubed glass, refrigerated	59 x 21¼ x 37 (149.9 x 53.8 x 94)	¾	120 AC	8.2	5-15P

Drop-In Display Cases

- Same great features as Vollrath's Countertop Units with an attractive base that can be used as a drop-in or countertop
- Use two or more for effective merchandising display lineups



40842

ITEM #	MODEL #	DESCRIPTION	DIMENSIONS (W X D X H): IN (CM)	HP/WATTAGE	VOLTAGE	AMPS	PLUG
40842	RDE7136	36" display cabinet, refrigerated	36 x 21 x 32½ (91.4 x 53.3 x 82.6)	½	120 AC	3.8	5-15P
40843	RDE7148	48" display cabinet, refrigerated	48 x 21 x 32½ (121.9 x 53.3 x 82.6)	¼	120 AC	4.9	5-15P
40844	RDE7160	60" display cabinet, refrigerated	60 x 21 x 32½ (152.4 x 53.3 x 82.6)	¼	120 AC	4.9	5-15P
40845	HDE7136	36" heated glass display cabinet	36 x 21 x 32 (91.4 x 53.3 x 81.3)	670	120 AC	5.6	5-15P
40846	HDE7148	48" heated glass display cabinet	48 x 21 x 32 (121.9 x 53.3 x 81.3)	710	120 AC	5.9	5-15P
40847	HDE7160	60" heated glass display cabinet	60 x 21 x 32 (152.4 x 53.3 x 81.3)	750	120 AC	6.3	5-15P

SHELF DIMENSIONS	TOP SHELF (DEPTH): IN (CM)	BOTTOM SHELF (DEPTH): IN (CM)
Curved glass display cabinets	9½ (24.1)	13 (33)
Cubed glass display cabinets	12 (30.5)	13 (33)
Drop-in curved display cabinets	7½ (19.1)	12.4 (31.5)

Cayenne® Hot Food Merchandisers

- Thermostatically controlled heat with 85°-175°F (29°-79°C) temperature range
- Front and rear sliding doors for easy loading and customer self-serve convenience
- Three adjustable shelves for versatile displays
- Lights controlled separately



40733



ITEM #	MODEL #	DIMENSIONS W X D X H: IN (CM)	VOLTAGE	WATTS	AMPS	PLUG
40733	FMA7026	26 x 19 x 25 (66 x 48.3 x 63.5)	120 AC	1440	12	5-15P
40734	FMA7036	36 x 19 x 25 (91.4 x 48.3 x 63.5)	120 AC	1440	12	5-15P
40735	FMA7048	47 x 19 x 25 (119.4 x 48.3 x 63.5)	120 AC	1440	12	5-15P

SHELF DIMENSIONS	TOP SHELF (DEPTH): IN (CM)	MIDDLE SHELF (DEPTH): IN (CM)	BOTTOM SHELF (DEPTH): IN (CM)
Cayenne Hot Food Merchandiser	12% (31.4)	13% (34)	14% (36.5)

Cayenne Bain Marie Hot Display Case

- Top-mounted halogen lighting for excellent food staging
- Versatile heating element allows well to be used wet or dry
- Double-skin stainless steel base reduces heat loss
- Use as drop-in or countertop



Rear drain valve



ITEM #	MODEL #	DIMENSIONS W X D X H: IN (CM)	VOLTAGE	WATTS	AMPS	PLUG
40732	BMA7103	43 x 31 x 29 (109.2 x 78.7 x 73.7)	120 AC	1440	12	5-15P

COMBINE DISPLAY CASES WITH A CAYENNE CHICKEN ROTISSERIE OVEN.

See page 42 for rotisserie ovens.





ACRYLIC DISPLAY CASES

NEW Cubic Modular Display Cases

- Clear acrylic cases attractively showcase the food
- Easily change setup based upon event, offerings, or available space
- Four 4" x 1" reusable chalk labels with white chalk included with each case
- Cases and cases with frames have a built-in stacking feature



SBC12



SBB13



SBB13F-06



SBB12



SBB12F-06

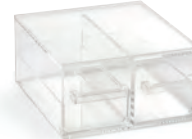

SBB23



SBB23F-06



SBB33



SBB2x2



SBC11



ANBCF-06



SBB13F-06
(2 pc stacked)

ITEM #	DESCRIPTION	DIMENSIONS (W X H X D): IN (CM)	CASE LOT
NON-FRAMED CASES			
SBB13*	1/3 display bin with drawer	6 ³ / ₈ x 7 ³ / ₈ x 14 (16.2 x 18.7 x 35.6)	1
SBB12*	1/2 display bin with drawer	10 x 7 ³ / ₈ x 14 (25.4 x 18.7 x 35.6)	1
SBB23*	2/3 display bin with 2 drawers	13 ³ / ₈ x 6 ³ / ₈ x 11 ³ / ₄ (25.4 x 16.2 x 29.8)	1
SBB33*	Full-size case with 3 drawers	20 x 7 ³ / ₈ x 14 (50.8 x 18.7 x 35.6)	1
SBB2x2*	2 x 2 display case with 4 drawers	20 x 7 ³ / ₈ x 14 (50.8 x 18.7 x 35.6)	1
SBC11*	Full-size case with front doors with pan #5303NS	20 x 7 ³ / ₈ x 14 (50.8 x 18.7 x 35.6)	1
NBC11*	Full-size nose case with front door with pan #5303NS	20 x 7 ³ / ₈ x 14 (50.8 x 18.7 x 35.6)	1
SBC12*	1/2 display case with front doors with pan #5220NS	10 x 7 ³ / ₈ x 14 (25.4 x 18.7 x 35.6)	1
CASES WITH BLACK METAL FRAMES			
SBB13F-06	1/3 display bin with drawer & black frame	9 ¹ / ₈ x 7 ³ / ₈ x 14 ¹ / ₂ (23 x 20 x 36.8)	1
SBB12F-06	1/2 display bin with drawer & black frame	12 ³ / ₈ x 7 ³ / ₈ x 14 ¹ / ₂ (31.4 x 20 x 36.8)	1
SBC12F-06	1/2 display case with front door & black frame	12 ³ / ₈ x 7 ³ / ₈ x 14 ¹ / ₂ (31.4 x 20 x 36.8)	1
SBB23F-06	2/3 display bin with 2 drawers & black frame	15 ³ / ₄ x 7 ³ / ₈ x 14 ¹ / ₂ (40 x 20 x 36.8)	1
SBB33F-06	Full-size case with 3 drawers & black frame	22 ³ / ₈ x 7 ³ / ₈ x 14 ¹ / ₂ (56.8 x 20 x 36.8)	1
SBC11F-06	Full-size case with front doors & black frame	22 ³ / ₈ x 7 ³ / ₈ x 14 ¹ / ₂ (56.8 x 20 x 36.8)	1
SBB2x2F-06	2 x 2 case with 4 drawers & black frame	15 ³ / ₄ x 14 ¹ / ₄ x 14 ¹ / ₂ (40 x 36.2 x 36.8)	1
NBCBB33F-06	Set: 1 nose case (NBC11), 1 3-full drawer with frame (SBB33F-06)	22 ³ / ₈ x 15 ¹ / ₄ x 14 ¹ / ₂ (40 x 38.7 x 36.8)	1
ANBCF-06	Set: 2 nose cases (NBC11), and angled stand (ANSTAND)	20 ³ / ₈ x 17 ³ / ₈ x 22 (40 x 44.8 x 55.9)	1
ANSTAND	Angled stand with shelves (cases sold separately)	21 ¹ / ₂ x 17 x 21 (54.6 x 43.2 x 53.3)	1
ACCESSORIES			
LBL8012655	24 reusable chalk labels (6 sheets with 4 labels each 1" x 4" 8012640)		1

*NSF certified

NEW Acrylic Display Cases

IMPROVED DESIGN AT A LOWER PRICE

- Heavy-duty ½" (1.3 cm) acrylic construction
- Individual soft-closing doors at each level for one-handed operation
- Includes 18" x 26" (45.7 x 66 cm) clear trays to enhance product presentation
- 23½" (58.4 cm) deep case fits easily on standard 24" (61 cm) standard countertops
- Integrated lower compartment for storage of bags, boxes, and tongs
- All-clear construction for maximum product visibility
- LED lighting option for enhanced merchandising



XLBC1F-1826-13



XLBC2FR-1826-13



XLBC3P-1826-13



ITEM #	DESCRIPTION	INCLUDES	DIMENSIONS (W X D X H): IN (CM)
XLBC3P-1826-13	Premium display case package with front and rear doors; package includes mirrored rear doors and LED lighting	Includes three 18" x 26" clear trays, lighting, mirror	28½ x 23½ x 32¾ (72.4 x 59.7 x 83.2)
XLBC3FR-1826-13	Premium display case with individual front and rear doors	Includes three 18" x 26" clear trays	28½ x 23½ x 32¾ (72.4 x 59.7 x 83.2)
XLBC3R-1826-13	Premium display case with rear doors only	Includes three 18" x 26" clear trays	28½ x 23½ x 32¾ (72.4 x 59.7 x 83.2)
XLBC3F-1826-13	Premium display case with individual front doors	Includes three 18" x 26" clear trays	28½ x 23½ x 32¾ (72.4 x 59.7 x 83.2)
XLBC2P-1826-13	Premium display case package with front and rear doors; package includes mirrored rear doors and LED lighting	Includes two 18" x 26" clear trays, lighting, mirror	28½ x 23½ x 26¾ (72.4 x 59.7 x 67.9)
XLBC2FR-1826-13	Premium display case with individual front and rear doors	Includes two 18" x 26" clear trays	28½ x 23½ x 26¾ (72.4 x 59.7 x 67.9)
XLBC2F-1826-13	Premium display case with individual front doors	Includes two 18" x 26" clear trays	28½ x 23½ x 26¾ (72.4 x 59.7 x 67.9)
XLBC1FR-1826-13	Premium display case with front and rear doors	Includes one 18" x 26" clear tray	28½ x 23½ x 15¼ (72.4 x 59.7 x 38.7)
XLBC1F-1826-13	Premium display case with individual front door	Includes one 18" x 26" clear tray	28½ x 23½ x 15¼ (72.4 x 59.7 x 38.7)

ACCESSORY

ITEM #	DESCRIPTION	DIMENSIONS (W X D X H): IN (CM)
EBC-TB	Clear acrylic tong, tissue, and bag organizer	24 x 13 x 4 (60.9 x 33 x 10.2)



Acrylic Display Cases

- Available with individual self-serve front doors and/or rear doors for quick restocking
- All-clear construction for maximum product visibility
- Rubber feet reduce slippage
- Knock-down case (KDC) models ship flat and assemble in minutes



LBC



LBC1418-3R-06

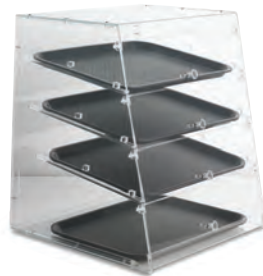

KDC1418-4F-06

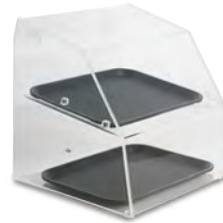

SBC1014-2R-06



KDC1418-2-06

ITEM #	DESCRIPTION	TRAY SIZE	DIMENSIONS W X D X H: IN (CM)
KNOCK-DOWN CASES			
KDC1418-2-06	Knock-down bakery case with front and rear doors	Includes two 14" x 18" black trays	18 ³ / ₈ x 16 ³ / ₄ x 12 (46.7 x 42.5 x 30.5)
KDC1418-3-06	Knock-down bakery case with front and rear doors	Includes three 14" x 18" black trays	18 ¹ / ₂ x 18 ³ / ₈ x 18 (46.9 x 46.7 x 45.7)
KDC1418-4R-06	Knock-down bakery case with split rear door	Includes four 14" x 18" black trays	18 ⁵ / ₈ x 19 ⁵ / ₈ x 23 (47.3 x 49.8 x 58.4)
KDC1418-4F-06	Knock-down bakery case with individual front doors	Includes four 14" x 18" black trays	18 ⁵ / ₈ x 19 ⁵ / ₈ x 23 (47.3 x 49.8 x 58.4)
CLASSIC CASES			
SBC1014-2F-06	Bakery case with front doors	Includes two 10" x 14" black trays	14 ¹ / ₂ x 14 ¹ / ₂ x 15 ¹ / ₄ (36.8 x 36.8 x 39.4)
SBC1014-2R-06	Bakery case with rear door	Includes two 10" x 14" black trays	14 ¹ / ₂ x 14 ¹ / ₂ x 15 ¹ / ₄ (36.8 x 36.8 x 39.4)
MBC1014-3F-06	Bakery case with front doors	Includes three 10" x 14" black trays	14 ¹ / ₂ x 17 x 21 (36.8 x 43.2 x 53.3)
MBC1014-3R-06	Bakery case with split rear doors	Includes three 10" x 14" black trays	14 ¹ / ₂ x 17 x 21 (36.8 x 43.2 x 53.3)
LBC1418-3F-06	Bakery case with front doors	Includes three 14" x 18" black trays	18 ¹ / ₂ x 19 ³ / ₄ x 22 (46.9 x 50.2 x 55.9)
LBC1418-3R-06	Bakery case with split rear doors	Includes three 14" x 18" black trays	18 ¹ / ₂ x 19 ³ / ₄ x 22 (46.9 x 50.2 x 55.9)
SBC	Angled front bakery case with front and rear doors	Includes three 14" x 18" white trays	19 ¹ / ₄ x 18 ¹ / ₄ x 21 ¹ / ₄ (48.9 x 46.4 x 54)
LBC	Angled front bakery case with front and rear doors	Includes three 18" x 26" white trays	28 x 24 x 28 (71.1 x 71.1 x 61)
EURO CASES			
ESBC-1	Euro-curve bakery case with rear door	Includes two 10" x 14" clear trays	16 ¹ / ₂ x 13 ¹ / ₂ x 15 ³ / ₈ (41.9 x 34.3 x 39.1)
ESBC-2	Euro-curve bakery case with front and rear doors	Includes two 10" x 14" clear trays	16 ¹ / ₂ x 13 ¹ / ₂ x 15 ³ / ₈ (41.9 x 34.3 x 39.1)
EMBC-1	Euro-curve bakery case with rear door	Includes three 14" x 18" clear trays	21 ¹ / ₂ x 21 ¹ / ₈ x 21 ¹ / ₂ (54.6 x 53.7 x 54.6)
EMBC-2	Euro-curve bakery case with front and rear doors	Includes three 14" x 18" clear trays	21 ¹ / ₂ x 21 ¹ / ₈ x 21 ¹ / ₂ (54.6 x 53.7 x 54.6)
ELBC-1	Euro-curve bakery case with rear door	Includes three 18" x 26" clear trays	29 ³ / ₄ x 24 ¹ / ₄ x 27 ³ / ₄ (75.6 x 61.6 x 70.5)
ELBC-2	Euro-curve bakery case with front and rear doors	Includes three 18" x 26" clear trays	29 ³ / ₄ x 24 ¹ / ₄ x 27 ³ / ₄ (75.6 x 61.6 x 70.5)

ACCESSORY

ITEM #	DESCRIPTION	CASE LOT
TH-1	Tong, holder, and tether	1



SOUP WARMING & MERCHANDISING

CREATING A CUSTOM SOUP MERCHANDISER IS SIMPLE. WE PROVIDE YOU WITH A TEMPLATE, AND YOU PROVIDE US WITH THE GRAPHICS.

(20-Working-days lead time and 10-Piece minimum per order)

CAYENNE® SOUP MERCHANDISERS

- Two wells with individual controls – holds two 7¼ qt insets; see page 59 for additional rethermalizer information
- Low water light eliminates guesswork
- Features Vollrath's Direct Contact Heating System for energy efficiency

CANOPY

- Powder-coated 1" tubular uprights for solid menu board and canopy support
- Halogen light fixture option with high/low switch

STAINLESS STEEL MENU BOARD

- Durable and magnetic for soup cards or merchandising items
- Easily removed without tools for cleaning
- Can be flipped to show the reverse side, allowing two alternative messaging options

ACCESSORY PACK

- Provides setups for two 7¼ qt insets or adapt for 4 qt insets
- Domestic and imported material



Accessory kit



02—Tuscan



03—Country kitchen



*International models only

Twin Well Soup Merchandisers

COUNTRY KITCHEN GRAPHIC ITEM #	TUSCAN GRAPHIC ITEM #	DESCRIPTION	DIMENSIONS (W X D X H): IN (CM)	VOLTAGE	WATTS	AMPS	PLUG	CASE LOT
7203203	7203202	TSM-27 base unit, menu board, canopy w/ light	24¾" x 14¾" x 47¾" (62.4 x 36.9 x 121.8)	120 AC	700	11.7	5-15P	1
7203103	7203102	TSM-27 base unit with menu board	24¾" x 14¾" x 33¾" (62.4 x 36.9 x 84.2)	120 AC	700	11.7	5-15P	1
7203003	7203002	TSM-27 base unit only	24¾" x 14¾" x 11¾" (62.4 x 36.9 x 29.3)	120 AC	700	11.7	5-15P	1
72231		Accessory pack includes (2) 7¼ qt insets (78184), (2) hinged Kool-Touch® covers (47488)*, and (2) 4 oz ladles (4980420)						1
72221		Adaptor ring allows use of 4 qt inset (78164) with 7 qt twin well merchandiser						1

*Hinged covers are not NSF® certified.

Full-Size Soup Merchandisers

COUNTRY KITCHEN GRAPHIC ITEM #	TUSCAN GRAPHIC ITEM #	DESCRIPTION	DIMENSIONS (W X D X H): IN (CM)	VOLTAGE	WATTS	AMPS	PLUG	CASE LOT
72020003	72020002	1220 base unit	21½" x 14¾" x 11" (54.61 x 36.07 x 27.9)	120 AC	1000	8.3	5-15P	1
720201003	720201002	1220 base with 4 qt accessory pack	21¾" x 13¾" x 9¾" (55.24 x 34.92 x 23.17)	120 AC	1000	8.3	5-15P	1
720202003	720202002	1220 base with 7 qt accessory pack	21½" x 14¾" x 13¾" (54.61 x 36.07 x 35)	120 AC	1000	8.3	5-15P	1
720200103	720200102	1220 base with menu board	21½" x 14¾" x 25½" (54.61 x 36.07 x 64.8)	120 AC	1000	8.3	5-15P	1
720201103	720201102	1220 base with menu board and 4 qt accessory pack	21½" x 14¾" x 25½" (54.61 x 36.07 x 64.8)	120 AC	1000	8.3	5-15P	1
720202103	720202102	1220 base with menu board and 7 qt accessory pack	21½" x 14¾" x 25½" (54.61 x 36.07 x 64.8)	120 AC	1000	8.3	5-15P	1

INTERNATIONAL MODEL

726302103	—	1220 base with 6.6 L accessory pack	26¼" x 18½" x 13¾" (66.7 x 47 x 35)	230 AC	1000	8.3	Schuko	1
-----------	---	-------------------------------------	-------------------------------------	--------	------	-----	--------	---

ACCESSORY PACK INCLUDES

4 qt accessory pack includes (1) 72228 adaptor plate, (3) 78164 insets, (3) 47486 hinged covers,* and (3) 4980320	1
---	---

7 qt accessory pack includes (1) 19192 adaptor plate, (2) 78184 insets, (2) 47488 hinged covers*, and (2) 4980420	1
---	---

*Hinged covers are not NSF certified.

For full-size soup merchandiser international models with 220-240V, change the first four digits to "7263" for Schuko or "7255" for UK (e.g., Schuko 720200003 to 726300003). Product details vary (e.g., voltage, amps, watts). Visit VOLLRATH.com.

Customizable Soup Carts

- All-aluminum composite material construction
- Black aluminum composite toe kick
- Laminate countertop
- Heavy-duty casters
- Standard accessories include napkin dispenser, two disposable soup cup dispensers, three ½ line pans, and two 11-qt drop-in soup wells

Visit VOLLRATH.com/soup for a comprehensive soup section that includes everything you need to turn soup into profits.



Contact Vollrath sales for more information about your next custom soup merchandiser – 800-628-0830.

NEW Contemporary Hinged Inset Covers

- Improved inset cover design
- Welded handle is permanently attached and stays secured to cover
- No friction-fit tabs to lose
- Handle serves as kickstand, keeping cover open for easy access to food
- Design of handle dissipates heat, keeping it cooler to the touch
- Fits most 7-quart and 11-quart insets
- Large opening for easy access



See page 99 for recommended Jacob's Pride ladles.



ITEM #	DESCRIPTION	OVERALL DIAMETER: IN (CM)	HEIGHT: IN (CM)	CASE LOT
47493	Hinged inset lid - 7¼ qt	9 ⁹ / ₁₆ (25.3)	2 ³ / ₄ (7)	1
47494	Hinged inset lid - 11 qt	11 ¹ / ₁₆ (30)	2 ³ / ₄ (7)	1

Hinged Inset Covers

- Mirror-finished stainless steel
- Welded clips on stationary side of cover hold it securely in place
- Kool-Touch® phenolic knob handle or finger flip lever
- Slot for ladles or spoons when cover is closed
- Easy one-hand operation



47488 Shown with inset, sold separately

ITEM #	DESCRIPTION	FITS INSET	DIAMETER: IN (CM)	HEIGHT: IN (CM)	CASE LOT
47486	Hinged inset cover with Kool-Touch phenolic knob handle	78164	7 ¹ / ₂ (19.0)	7 ¹ / ₁₆ (2.2)	6
47488	Hinged inset cover with Kool-Touch phenolic knob handle	46063-2, 77070, 78184	9 ⁵ / ₁₆ (24.4)	1 ⁵ / ₁₆ (2.4)	6
47490	Hinged inset cover with Kool-Touch phenolic knob handle	77110, 78204	11 ¹ / ₁₆ (29.1)	1 ⁵ / ₁₆ (2.4)	6

Flip-Top Cover Hinge

- Flip hinge
- Fits 4 qt (3.8 L), 7 qt (6.6 L), and 11 qt (10.4 L) insets and covers
- Dishwasher safe
- Includes hinge, clip-lip, springlock assembly, and black knob — inset and cover not included



ITEM #	DESCRIPTION	CASE LOT
72222	Flip-top cover hinge	1



FROZEN TREAT EQUIPMENT

One of the fastest-growing and most profitable categories in foodservice, frozen treats delight kids and adults alike. Make creating non-alcoholic and alcoholic drinks easy with these easy-to-clean, durable machines.

Frozen Beverage Granita Machine

Vollrath Frozen Beverage Granita Machines are designed for cold or frozen slush and milk-based drinks including granitas, iced or frozen coffee or tea, frozen cocktails, smoothies, and more. Ideal for bars, convenience, stores and other operations that want to expand their beverage offerings, these machines are easy to use and effortless to maintain. Plus, their multiple point-of-sale locations can be customized to fit any business model.

- Magnetic drive system is reliable, durable, and easy to use
- Easy-to-use controls with simple switch operation
- Gasketless spigot is easy to clean and maintain
- Large freezing surface and properly sized compressor reduces freeze downtimes and promotes efficient operation
- Optional double-wall bowls ensure minimal condensation on the outside of unit



VCBA118-37



VCBA128-37



VCBA168-37

VOLLRATH.com/frobev



Learn how to clean your Vollrath Frozen Beverage Granita Machine by visiting VOLLRATH.com/frobev.



VCBF118-37



VCBF128-37



VCBF168-37

ITEM #	DESCRIPTION	DIMENSIONS (W X D X H): IN (CM)	VOLTAGE AC	AMPS	PLUG	CASE LOT
VCBA118-37	One 6-liter bowl	7¾ x 19½ x 23¾ (19.4 x 49.7 x 60.5)	120	4	NEMA 5-15P	1
VCBA128-37	Two 6-liter bowls	15½ x 19½ x 23¾ (39.4 x 49.7 x 60.5)	120	6	NEMA 5-15P	1
VCBA168-37	Three 6-liter bowls	23½ x 19½ x 23¾ (59.4 x 49.7 x 60.5)	120	9.6	NEMA 5-15P	1
VCBF118-37	One 10-liter bowl	7¾ x 19½ x 27 (19.4 x 49.7 x 68.4)	120	4.8	NEMA 5-15P	1
VCBF128-37	Two 10-liter bowls	15½ x 19½ x 27 (39.4 x 49.7 x 68.4)	120	10	NEMA 5-15P	1
VCBF168-37	Three 10-liter bowls	23½ x 19½ x 27 (59.4 x 49.7 x 68.4)	120	13.9	NEMA 5-15P	1

ACCESSORIES

BR018	Double Wall Bowl Kit (6-liter)					1
BR0208	Double Wall Bowl Kit (10-liter)					1

Ice Cream Scoops

- Antifreeze encapsulated in handle for easy release from scoop bowl
- Patented ergonomic textured handle design for a secure grip
- Hanging hole for easy storage
- Durable cast aluminum
- Industry-standard bowl dimensions for consistent portioning
- Colored end cap to easily identify size/capacity
- Hand-wash only



ITEM #	END CAP COLOR	SIZE	CAPACITY: OZ (ML)	OVERALL LENGTH: IN (CM)	OVERALL HEIGHT: IN (CM)	BOWL WIDTH: IN (CM)	CASE LOT
47274	Brown	10	4 (118.3)	7 ⁵ / ₈ (19.4)	1 ¹ / ₈ (4.8)	2 ¹ / ₈ (5.4)	12
47275	Blue	12	3 (88.7)	7 ⁵ / ₈ (19.4)	1 ¹ / ₈ (4.8)	2 ⁷ / ₈ (5.2)	12
47276	Green	16	2 ¹ / ₂ (73.9)	7 ³ / ₄ (19.7)	1 ¹ / ₈ (4.8)	1 ¹ / ₈ (4.8)	12
47277	Gold	20	2 (59.1)	7 ⁷ / ₈ (18.9)	1 ¹ / ₈ (4.3)	1 ³ / ₄ (4.4)	12
47278	Grey	24	1 ¹ / ₂ (44.4)	7 ⁵ / ₈ (19.4)	1 ¹ / ₈ (3.7)	1 ¹ / ₈ (4.1)	12
47279	Red	30	1 (29.6)	7 ¹ / ₂ (19.1)	1 ¹ / ₈ (3.3)	1 ¹ / ₈ (3.7)	12

Ice Cream Spade

- Use for scraping sides and leveling the ice cream in tubs
- Great for hand-packing containers and mixing
- Extended handle to reach deep into containers
- Reduces waste by preventing the formation of crystals
- Antifreeze encapsulated in handle for easy food product release
- Aluminum spade with blue polypropylene end cap



ITEM #	OVERALL LENGTH: IN (CM)	CASE LOT
47270	10 ¹ / ₈ (25.8)	12

Ice Cream/Utility Spade

- Stainless steel
- Black plastic handle



ITEM #	OVERALL LENGTH: IN (CM)	CASE LOT
47165	9 (22.9)	12

Ice Cream Service

- Mirror-finished stainless steel



ITEM #	SILVERPLATE ITEM #	DESCRIPTION	CAPACITY	DIMENSIONS IN (CM)	CASE LOT
48013	48313	Paneled sherbet dish with scalloped top	3 ¹ / ₂ oz (103 ml)	1 ¹ / ₈ (4.8) height	12
48015	48315	Paneled sherbet dish with scalloped top	5 oz (148 ml)	2 ¹ / ₄ (5.7) height	12
46701	48301	Paneled sherbet dish with gadroon base	16 oz (473 ml)	3 ³ / ₈ (8.6) height	12
46772	48372	Sauce bowl with gadroon top	2 oz (59 ml)	3 x 3 (7.6 x 7.6) (h x dia)	72
48003	48303	Sherbet bowl with gadroon top	3 ¹ / ₂ oz (103 ml)	2 x 3 ³ / ₈ (5.1 x 9.6) (h x dia)	12
46704	—	Dessert cup with paneled design	4 oz (118 ml)	1 ⁵ / ₈ x 3 ³ / ₈ (4.1 x 9.3) (h x dia)	48
48060	—	Tulip sundae with gadroon base	6 oz (177 ml)	4 ⁵ / ₈ (12) height	12
T720DW	—	Hammered double-wall ice cream chiller	3 gal (3.8 L)	10 ³ / ₄ x 11 ⁵ / ₈ (29.5 x 27.3) (h x dia)	1

SERVING SYSTEMS
& COMPONENTS

VOLLRATH



SERVING SYSTEMS & COMPONENTS

We know creating a custom design involves a lot of decisions – and it can be time consuming to get approval from your whole team. We'll help you through every step of the process. Get a copy of our Serving Systems & Components brochure today and let's start building something beautiful together.

Request your copy today by visiting
VOLLRATH.com/catalogs.





STEAM TABLE PANS & ACCESSORIES

Store, transport, and serve your food safely and elegantly with the extremely durable Super Pan® steam table pans. Choose from an extensive selection of shapes and sizes designed to lend an upscale appearance to your food presentations.

How to Shop

STEAM TABLE PANS



Super Shapes Lineup

Create upscale food presentations in chafers, heated or refrigerated buffet lines, display cases, and more with Vollrath Super Pan® Super Shapes. They're constructed of strong 22-gauge, 300 series stainless steel to stand the test of time in even the toughest kitchen environments.

Page 83



Super Pan V® and Accessories

Smooth curves, easy-to-pour corners, and bright finishes give Super Pan V Steam Table Pans their stunning appearance and increase their functionality. These 22-gauge, 300 series stainless steel pans are 300% stronger than Super Pan II® and resist dents and dings in even the toughest kitchen environment.

Pages 84-88



Super Pan V Steam Table Pans
now with Jacob's Pride® lifetime warranty



Super Pan 3® and Accessories

Made in the US, these EN631-compliant Gastronorm (GN) pans are designed for worldwide use. Super Pan 3 pans are constructed of sturdy 22-gauge, 300 series stainless steel. They feature anti-jamming lugs, unique ramped sides, and reinforced pour corners for durability and ease of use.

Pages 89-91



Super Pan® Plastic Pans

Available for low-temperature and high-temperature applications, our plastic pans feature a built-in anti-jamming design and unique ramped sides for easy removal.

Pages 92-93



Watch Chef Rich demonstrate what a Vollrath Super Pan V® goes through in a typical commercial kitchen environment.

Specialty Pans



From heavy-duty 20-gauge pans to pans designed specifically for transport, we have a variety of options designed to make cooking, transporting, and serving easier.

[Pages 95-96](#)

Universal Accessories



- Pan Bands [Page 97](#)
- Covers [Page 98](#)
- Egg Poachers [Page 97](#)
- Clip-On Handles [Page 98](#)

Insets & Bain Maries



Our NSF-certified insets and bain maries are ideal for condiments, salad dressings, and assorted toppings. Constructed of satin-finished 300 series stainless steel, they feature a sanitary open bead on the edge and recessed stainless steel covers for sanitary storage.

[Page 99](#)

Adaptor Plates



Available in a variety of sizes and shapes, our adaptor plates feature 300 series stainless steel for outstanding durability. Explore the selection and add unmatched versatility to your buffet line.

[Pages 100-101](#)

SUPER SHAPES LINEUP



UPSCALE YOUR FOOD PRESENTATION

- Displays beautifully with Super Pan V® and Super Pan 3®
- Unique shapes enhance food presentation
- Upscale food presentation with minimal investment
- Reduced capacity reduces food waste
- Pans stack neatly within themselves for easy storage
- 22-gauge, 300 series stainless steel



PAN SHAPE	ITEM #	DESCRIPTION	1 OZ PORTION	PAN DIMENSIONS		BRIMFUL CAPACITY QT (L)	PAN CASE LOT	SOLID COVER	SLOTTED COVER	FLEX COVER	COVER CASE LOT
				L X W: IN (MM)	HEIGHT: IN (MM)						
	3100020	Wild pan – long	120	20¼ x 12 ¹³ / ₁₆ (530 x 325)*	2½ (65)	3.7 (3.5)	6	—	—	—	—
	3100040	Wild pan – long	163	20¼ x 12 ¹³ / ₁₆ (530 x 325)*	3½ (89)	5.1 (4.8)	6	—	—	—	—
	3100220	Wild pan – short	134	20¼ x 12 ¹³ / ₁₆ (530 x 325)*	2½ (65)	4.1 (3.9)	6	—	—	—	—
	3100240	Wild pan – short	205	20¼ x 12 ¹³ / ₁₆ (530 x 325)*	4 (100)	6.4 (6.1)	6	—	—	—	—
	3100320	Wild pan – third outer	82	20¼ x 12 ¹³ / ₁₆ (530 x 325)**	2½ (65)	2.6 (2.5)	6	—	—	—	—
	3100340	Wild pan – third outer	122	20¼ x 12 ¹³ / ₁₆ (530 x 325)**	4 (100)	3.8 (3.6)	6	—	—	—	—
	3100321	Wild pan – third inner	82	20¼ x 12 ¹³ / ₁₆ (530 x 325)**	2½ (65)	2.6 (2.5)	6	—	—	—	—
	3100341	Wild pan – third inner	122	20¼ x 12 ¹³ / ₁₆ (530 x 325)**	4 (100)	3.8 (3.6)	6	—	—	—	—
	3101015	Oval – full	124	20¼ x 12 ¹³ / ₁₆ (530 x 325)	2 (51)	3.9 (3.7)	6	93100	94100	52430	6
	3101020	Oval – full	155	20¼ x 12 ¹³ / ₁₆ (530 x 325)	2½ (65)	4.8 (4.6)	6	93100	94100	52430	6
	3101040	Oval – full	270	20¼ x 12 ¹³ / ₁₆ (530 x 325)	4 (102)	8.2 (7.8)	6	93100	94100	52430	6
	3102015	Oval – half	55	10¼ x 12 ¹³ / ₁₆ (265 x 325)	2 (51)	1.7 (1.6)	6	93200	94200	—	6
	3102020	Oval – half	69	10¼ x 12 ¹³ / ₁₆ (265 x 325)	2½ (65)	2.2 (2.1)	6	93200	94200	—	6
	3102040	Oval – half	118	10¼ x 12 ¹³ / ₁₆ (265 x 325)	4 (102)	3.7 (3.5)	6	93200	94200	—	6
	3103040	Oval – third	69	6 ¹⁵ / ₁₆ x 12 ¹³ / ₁₆ (176 x 325)	4 (102)	2.2 (2.1)	6	93300	94300	—	6
	3101220	Hexagon – full	170	20¼ x 12 ¹³ / ₁₆ (530 x 325)	2½ (65)	5.8 (5)	6	93100	94100	52430	6
	3101240	Hexagon – full	298	20¼ x 12 ¹³ / ₁₆ (530 x 325)	4 (100)	9.3 (8.8)	6	93100	94100	52430	—
	3102220	Hexagon – half	71	10¼ x 12 ¹³ / ₁₆ (265 x 325)	2½ (65)	2.2 (2.1)	6	93200	94200	—	6
	3102240	Hexagon – half	122	10¼ x 12 ¹³ / ₁₆ (265 x 325)	4 (100)	3.8 (3.6)	6	93200	94200	—	—
		3101120	Kidney – full	162	20¼ x 12 ¹³ / ₁₆ (530 x 325)	2½ (65)	5.1 (4.8)	6	93100	94100	52430
3102120		Kidney – half	71	10¼ x 12 ¹³ / ₁₆ (265 x 325)	2½ (65)	2.2 (2.1)	6	93200	94200	—	6
ADAPTOR BAR											
	75015	Adaptor bar for wild pan – long, use with 3100020 and 3100040					12	—	—	—	—
	75013	Adaptor bar for wild pan – short and wild pan – third, use with 3100220, 3100240, 3100320, 3100340, and 3100341					12	—	—	—	—

*Overall dimensions for a set of two

**Overall dimensions for two outer pans and one inner pan

SUPER PAN V® & ACCESSORIES



The Super Behind **SUPER PAN V**

Featuring easy-pour corners and 22-gauge, 300 series stainless steel, Super Pan V is up to 300% stronger than Super Pan II® and will resist dents and dings in busy kitchen environments. Smooth curves and a bright finish make cleaning easier and present food beautifully.

The patented design of Super Pan V steam table pans provides superior performance backed by our Jacob's Pride® limited lifetime warranty. This superior performance and durability results in less potential for damaged pans. Super Pan V steam table pans save energy costs and increase food quality. Independent testing shows an annual average energy savings of \$36 per well.

STRONG. SMART. STUNNING

- Smooth curves and bright finish for an elegant presentation
- Easy-to-pour corners up to 300% stronger
- 22-gauge, 300 series stainless steel resists dents and dings
- **NEW 1/2 SIZE** provides 40% more capacity than 1/3 sized pans, reducing the number of empty pans and the time it takes to fill them.

Adds 40% more capacity!

NEW



NOW GOOD FOR LIFE!

Super Pan V Steam Table Pans have been added to the line of Jacob's Pride® lifetime warrantied items.









SUPER PAN V[®]



STRONG. SMART. STUNNING

- Smooth curves and bright finish for an elegant presentation
- Easy-to-pour corners up to 300% stronger
- 22-gauge, 300 series stainless steel resists dents and dings
- Now with Jacob's Pride[®] Lifetime Warranty
- New 1/8 size provides 40% more capacity than 1/4 sized pans, reducing the number of empty pans and the time it takes to fill them.



PAN SIZE AND DIMENSIONS	ITEM #	DEPTH IN (MM)	BRIMFUL CAPACITY QT (L)	PAN CASE LOT	SOLID COVER	CASE LOT	SLOTTED COVER	CASE LOT	WIRE GRATE	CASE LOT	FALSE BOTTOM	CASE LOT
 FULL-SIZE 20 ³ / ₄ x 12 ³ / ₄ in 527 X 324 mm 1/4	30002	3/4 (20)	Tray	6	77250	6	75210	6	20028	12	20000	6
	30012	1/4 (35)	3.9 (3.7)	6	77250	6	75210	6	20028	12	20000	6
	30022	2 1/2 (65)	8.3 (7.9)	6	77250	6	75210	6	20028	12	20000	6
	30042	4 (100)	14 (13.3)	6	77250	6	75210	6	20028	12	20000	6
	30062	6 (150)	21 (19.9)	6	77250	6	75210	6	20028	12	20000	6
 TWO-THIRDS SIZE 13 ³ / ₈ x 12 ³ / ₄ in 352 x 324 mm 2/3	30102	3/4 (20)	Tray	6	75110	6	—	—	—	—	21110	6
	30112	1/4 (35)	3 (2.8)	6	75110	6	—	—	—	—	21110	6
	30122	2 1/2 (65)	5.6 (5.3)	6	75110	6	—	—	—	—	21110	6
	30142	4 (100)	9.3 (8.8)	6	75110	6	—	—	—	—	21110	6
	30162	6 (150)	14 (13.3)	3	75110	6	—	—	—	—	21110	6
 HALF-SIZE 10 ³ / ₈ x 12 ³ / ₄ in 264 x 324 mm 1/2	30202	3/4 (20)	Tray	6	75120	6	—	—	—	—	—	—
	30212	1/4 (35)	2.1 (2)	6	75120	6	75220	6	20228	12	20200	6
	30222	2 1/2 (65)	4.3 (4.1)	6	75120	6	75220	6	20228	12	20200	6
	30242	4 (100)	6.7 (6.3)	6	75120	6	75220	6	20228	12	20200	6
	30262	6 (150)	10 (9.5)	6	75120	6	75220	6	20228	12	20200	6
 HALF-LONG SIZE 20 ³ / ₄ x 6 ³ / ₄ in 527 x 164 mm 3/4	30512	1/4 (35)	1.9 (1.8)	6	93500	6	94500	6	—	—	—	—
	30522	2 1/2 (65)	3.8 (3.6)	6	93500	6	94500	6	—	—	—	—
	30542	4 (100)	6 (5.7)	3	93500	6	94500	6	—	—	—	—
	30562	6 (150)	8.7 (8.2)	3	93500	6	94500	6	—	—	—	—
 THIRD-SIZE 6 ³ / ₈ x 12 ³ / ₄ in 175 x 324 mm 1/3	30302	3/4 (20)	Tray	6	75130	6	75230	6	20328	6	20300	6
	30312	1/4 (35)	1.3 (1.2)	6	75130	6	75230	6	20328	6	20300	6
	30322	2 1/2 (65)	2.6 (2.5)	6	75130	6	75230	6	20328	6	20300	6
	30342	4 (100)	4.1 (3.9)	6	75130	6	75230	6	20328	6	20300	6
	30362	6 (150)	6.1 (5.8)	6	75130	6	75230	6	20328	6	20300	6
 FOURTH-SIZE 6 ³ / ₈ x 10 ³ / ₈ in 162 x 264 mm 1/4	30402	3/4 (20)	Tray	6	75140	6	75240	6	—	—	20400	6
	30412	1/4 (35)	1.2 (1.1)	6	75140	6	75240	6	—	—	20400	6
	30422	2 1/2 (65)	1.8 (1.7)	6	75140	6	75240	6	—	—	20400	6
	30442	4 (100)	3 (2.8)	6	75140	6	75240	6	—	—	20400	6
	30462	6 (150)	4.5 (4.3)	6	75140	6	75240	6	—	—	20400	6

Specifications: Super Pan V shall be 22-gauge, 300 series stainless steel. Top outside shall be designed with built-in concave, diagonally tapered corners for impact resistance, which also acts as pouring spout. All depths of solid pans shall have anti-jamming design to prevent pans from sticking together. Reverse formed edge shall be polished and flattened for consistent tangent to well opening and for hand comfort. Product identification to be laser etched on pan. NSF certified.

NEW

1/8" SIZE PANS ADD 40% MORE CAPACITY!



SUPER PAN V® CHART CONTINUED

PAN SIZE AND DIMENSIONS	ITEM #	DEPTH IN (MM)	BRIMFUL CAPACITY QT (L)	PAN CASE LOT	SOLID COVER	CASE LOT	SLOTTED COVER	CASE LOT	WIRE GRATE	CASE LOT	FALSE BOTTOM	CASE LOT	
	SIXTH-SIZE 6 7/8 x 6 1/4 in 175 x 159 mm 1/8"	30622	2 1/2 (65)	1.2 (1.1)	6	75160	6	75260	6	—	—	20600	6
	30642	4 (100)	1.8 (1.7)	6	75160	6	75260	6	—	—	20600	6	
	30662	6 (150)	2.7 (2.5)	6	75160	6	75260	6	—	—	20600	6	
	EIGHTH-SIZE 6 3/8 x 5 1/4 in 162 x 132 mm 1/8"	30822	2 1/2 (65)	.82 (.78)	8	75180	8	75280	8	—	—	20800	8
	30842	4 (100)	1.3 (1.2)	8	75180	8	75280	8	—	—	20800	8	
	30862	6 (150)	1.7 (1.6)	8	75180	8	75280	8	—	—	20800	8	
	NINTH-SIZE 6 7/8 x 4 1/4 in 175 x 108 mm 1/8"	30922	2 (50)	0.6 (0.5)	6	75360	6	75460	6	—	—	—	—
	30942	4 (100)	1.1 (1)	6	75360	6	75460	6	—	—	—	—	

Specifications: Super Pan V shall be 22-gauge, 300 series stainless steel. Top outside shall be designed with built-in concave, diagonally tapered corners for impact resistance, which also acts as pouring spout. All depths of solid pans shall have anti-jamming design to prevent pans from sticking together. Reverse formed edge shall be polished and flattened for consistent tangent to well opening and for hand comfort. Product identification to be laser etched on pan. NSF certified.

The Real Cost of an Economy Pan

SAVE AN ANNUAL AVERAGE OF \$34* ON ENERGY COSTS PER FULL-SIZE PAN OPENING!

kWh (kilowatt hour) usage shows that Super Pan® is 38% more efficient!



STEAM TABLE PAN	KWH USAGE	TOTAL ANNUAL HRS.	TOTAL ANNUAL KWH	PRICE PER KWH	TOTAL ANNUAL COST
Super Pan®	0.20	2488	497.60	\$0.11	\$54.74
Competitor w/ bent edges	0.32	2488	796.16	\$0.11	\$87.58

Average annual savings of \$36.56

*Third-party testing on Super Pan 3®

Total hours based on 8 hours a day / 311 days a year

Average commercial retail price of electricity = \$0.11/kWh as of June 2018 per U.S. Dept. of Energy website: www.eia.gov

SUPER PAN V® ACCESSORIES



Super Pan V Perforated Pans

- 22-gauge (.8 mm), 300 series stainless steel
- Ideal for steaming foods or draining away fats, juices, or moisture
- For 1¼" all-natural deep pans, drain holes are located in the bottom only



PAN SIZE	ITEM #	DEPTH: IN (MM)	CASE LOT
¼	30013	1¼ (35)	6
¼	30023	2½ (65)	6
¼	30043	4 (100)	6
¼	30063	6 (150)	6
⅓	30113	1¼ (35)	6
⅓	30123	2½ (65)	6
⅓	30143	4 (100)	6
⅓	30163	6 (150)	6
½	30213	1¼ (35)	6
½	30223	2½ (65)	6
½	30243	4 (100)	6
½	30263	6 (150)	6



Super Pan V False Bottoms

- 300 series stainless steel
- Hold foods above pan bottom for draining
- Diameter of small holes: ⅜" all-natural (9.5 mm)
- Finger holes allow easy removal from pan



PAN SIZE	ITEM #	DIMENSIONS: IN (CM)	CASE LOT
¼	20000	17⅞ x 9⅜ x ⅞ (43.5 x 24.9 x 1.4)	6
½	20200	6⅜ x 9⅜ x ⅞ (17.3 x 24.9 x 1.4)	6
⅓	21110	9⅜ x 11⅜ x ⅞ (25.2 x 29.4 x 1.4)	6
¾	20100	17¾ x 3¾ x ⅞ (45 x 9.6 x 1.4)	6
⅓	20300	9⅜ x 4 x ⅞ (23.3 x 10.2 x 1.4)	6
¼	20400	7⅞ x 3¾ x ⅞ (18.1 x 9.5 x 1.4)	6
⅓	20600	4⅜ x 4 x ⅞ (11.2 x 10.2 x 1.4)	6



Super Pan V with Nonstick Interior

- SteelCoat x3™ nonstick coating, made without PFOA
- Black interior enhances both cold- and hot-food presentations
- Not for use with metal utensils
- Temperature tolerance of -20° to 450°F (-28 to 230°C)



PAN SIZE	ITEM #	DEPTH IN (MM)	BRIMFUL CAPACITY QT (L)	CASE LOT
¼	70012	1½ (40)	3.9 (3.7)	6
¼	70022	2½ (65)	8.3 (7.9)	6
¼	70042	4 (100)	14 (13.3)	6
½	70212	1¼ (35)	2.1 (2)	6
½	70222	2½ (65)	4.3 (4.1)	6
½	70242	4 (100)	6.7 (6.3)	6
⅓	70322	2½ (65)	2.6 (2.5)	6
⅓	70342	4 (100)	4.1 (3.9)	6
⅓	70362	6 (150)	6.1 (5.8)	6



Super Pan V Wire Grates

- Heavy-duty, 300 series stainless steel wire construction – the only full stainless steel grate in the industry
- Stainless steel construction eliminates peeling or cracking from salty foods
- Ample finger room for easy removal from pan
- Use as a roasting, cooling, icing, display or drying rack
- Oven safe

PAN SIZE	ITEM #	DIMENSIONS: IN (CM)	CASE LOT
¼	20028	18 x 10 x ¾ (45.7 x 25.4 x 1.9)	12
½	20228	11⅞ x 8⅜ x ¾ (28.2 x 22.4 x 1.9)	12
⅓	20328	10⅞ x 5⅞ x ¾ (27.5 x 12.9 x 1.9)	6
BUN PAN SIZE			
¼	20038	24 x 16½ x ⅞ (60.9 x 41.9 x 2.2)	6
½	20248	16½ x 11¾ x ⅞ (41.9 x 29.8 x 2.2)	6

Only Wire Grates on the market made of Stainless Steel!

Super Pan V® Solid and Slotted Covers

- Stainless steel
- Reinforced edges provide added strength to the perimeter of the cover
- Solid covers are NSF® certified



PAN SIZE	SOLID ITEM #	SLOTTED ITEM #	CASE LOT
¼	77250	75210*	6
⅓	75110	—	6
½	75120	75220*	6
¾	93500	94500*	6
⅓	75130	75230*	6
¼	75140	75240*	6
⅙	75160	75260*	6
⅙	75360	75460*	6

* Slotted covers are not NSF certified.

Super Pan V Flexible Pan Lids

- Low-density polyethylene is non-staining and dishwasher safe
- Safe to use in temperatures ranging from -20°F to 190°F (-28°C to 88°C)
- Lids allow pans to be stacked for space-saving cold-food storage



PAN SIZE	ITEM #	COLOR	CASE LOT
¼	52430	White	6
¼	52430-02	Red	6
½	52431	White	6
⅓	52432	White	6
⅓	52432-02	Red	6
¼	52433	White	6
⅙	52434	White	6
⅙	52434-02	Red	6
⅙	52435	White	6

Note: For use with full-size Super Shapes Steam Table Pans, see page 83.

SECURE PAN LIDS TO STEAM TABLE PANS WITH THESE HIGH-TEMPERATURE SILICONE BANDS

- Patented high-temperature silicone band (oven safe up to 450°F (223.2°C))
- Secures cover, polyfirm, or aluminum foil to pan for spill-resistant storage and transportation
- Dishwasher safe
- Easy to apply
- Available in black or gray
- See page 97 for more details



Visit VOLLRATH.com/panband to view the Pan Bands product demo with Chef Rich.



SUPER PAN 3[®] & ACCESSORIES









THE WORLDWIDE PAN

- EN631-1 compliant for worldwide use
- Sturdy 22-gauge (.8 mm), 300 series stainless steel
- Anti-jamming lugs and reinforced spouted-shape corners
- NSF[®]-certified solid and slotted covers
- All accessories are specifically designed to serve the European market





Super Pan 3 Stainless Steel Pans

PAN SIZE AND DIMENSIONS	ITEM #	DEPTH IN (MM)	BRIMFUL CAPACITY QT (L)	PAN CASE LOT	SOLID COVER	SLOTTED COVER	WIRE GRATE	FALSE BOTTOM	CASE LOT
 FULL-SIZE 20 ⁷ / ₁₆ x 12 ¹³ / ₁₆ in. 530 X 325 mm 1/4	90002	3/4 (20)	Tray	6	—	—	74100*	70100	6
	90012	1 1/2 (40)	5.7 (5.4)	6	93100	94100	74100*	70100	6
	90052	2 (55)	7.7 (7.3)	6	93100	94100	74100*	70100	6
	90022	2 1/2 (65)	9 (8.5)	6	93100	94100	74100*	70100	6
	90042	4 (100)	14.2 (13.4)	6	93100	94100	74100*	70100	6
	90062	6 (150)	20.1 (19.9)	6	93100	94100	74100*	70100	6
 TWO-THIRDS SIZE 13 ⁵ / ₁₆ x 12 ¹³ / ₁₆ in. 354 x 325 mm 2/3	90082	8 (200)	27.5 (26.1)	3	93100	94100	74100*	70100	6
	90102	3/4 (20)	Tray	6	—	—	—	70110	6
	90112	1 1/2 (40)	3.6 (3.4)	6	93110	—	—	70110	6
	90122	2 1/2 (65)	5.7 (5.4)	6	93110	—	—	70110	6
	90142	4 (100)	8.5 (8)	6	93110	—	—	70110	6
	90162	6 (150)	12.6 (11.9)	3	93110	—	—	70110	6
 HALF-SIZE 12 ⁵ / ₁₆ x 10 ⁷ / ₁₆ in. 325 x 265 mm 1/2	90182	8 (200)	16.4 (15.5)	3	93110	—	—	70110	6
	90202	3/4 (20)	Tray	6	—	—	74200*	70200	6
	90212	1 1/2 (40)	2.6 (2.4)	6	93200	94200	74200*	70200	6
	90252	2 (55)	3.5 (3.3)	6	93200	94200	74200*	70200	6
	90222	2 1/2 (65)	4 (3.8)	6	93200	94200	74200*	70200	6
	90242	4 (100)	6.3 (6)	6	93200	94200	74200*	70200	6
 HALF-LONG SIZE 20 ⁷ / ₁₆ x 6 ³ / ₁₆ in. 530 x 162 mm 3/4	90262	6 (150)	9.4 (8.9)	6	93200	94200	74200*	70200	6
	90282	8 (200)	12.2 (11.6)	3	93200	94200	74200*	70200	6
	90502	3/4 (20)	Tray	6	—	—	—	70500	6
	90512	1 1/4 (30)	2.5 (2.4)	6	93500	94500	—	70500	6
	90552	2 (55)	3.3 (3.1)	6	93500	94500	—	70500	6
	90522	2 1/2 (65)	3.9 (3.7)	6	93500	94500	—	70500	6
 THIRD-SIZE 6 ⁵ / ₁₆ x 12 ¹³ / ₁₆ in. 176 x 325 mm 1/3	90542	4 (100)	6 (5.7)	3	93500	94500	—	70500	6
	90562	6 (150)	8.7 (8.2)	3	93500	94500	—	70500	6
	90302	3/4 (20)	Tray	6	—	—	74300*	70300	6
	90312	1 1/2 (40)	1.7 (1.6)	6	93300	94300	74300*	70300	6
	90352	2 (55)	2.1 (2)	6	93300	94300	74300*	70300	6
	90322	2 1/2 (65)	2.5 (2.4)	6	93300	94300	74300*	70300	6
	90342	4 (100)	3.9 (3.7)	6	93300	94300	74300*	70300	6
	90362	6 (150)	5.8 (5.5)	6	93300	94300	74300*	70300	6
	90382	8 (200)	7.5 (7.1)	3	93300	94300	74300*	70300	6

*Imported, not NSF
For pan layouts, see page 94.

Product selection continues on next two pages

SUPER PAN 3® CHART, CONTINUED



PAN SIZE AND DIMENSIONS	ITEM #	DEPTH IN (MM)	BRIMFUL CAPACITY QT (L)	PAN CASE LOT	SOLID COVER	SLOTTED COVER	WIRE GRATE	FALSE BOTTOM	CASE LOT
 FOURTH-SIZE 6 ³ / ₁₆ x 10 ⁷ / ₁₆ in. 162 x 265 mm ¼	90402	¾ (20)	Tray	6	—	—	—	70400	6
	90412	1½ (40)	1.2 (1.1)	6	93400	94400	—	70400	6
	90452	2 (55)	1.6 (1.5)	6	93400	94400	—	70400	6
	90422	2½ (65)	1.8 (1.7)	6	93400	94400	—	70400	6
	90442	4 (100)	2.7 (2.6)	6	93400	94400	—	70400	6
	90462	6 (150)	4 (3.8)	6	93400	94400	—	70400	6
 SIXTH-SIZE 6 ⁵ / ₁₆ x 6 ³ / ₁₆ in. 176 x 162 mm ⅙	90622	2½ (65)	1.1 (1.1)	6	93600	94600	—	70600	6
	90642	4 (100)	1.7 (1.6)	6	93600	94600	—	70600	6
	90662	6 (150)	2.4 (2.3)	6	93600	94600	—	70600	6
	90682	8 (200)	3.2 (3)	3	93600	94600	—	70600	6
 NINTH-SIZE 6 ⁵ / ₁₆ x 4¼ in. 176 x 108 mm ⅑	90922	2½ (65)	0.6 (0.6)	6	93900	94900	—	70600	6
	90942	4 (100)	0.9 (0.8)	6	93900	94900	—	70600	6

Specifications: Super Pan 3 shall be 300 series stainless steel. Corner on top of flange shall be designed with built-in concave indentation for impact resistance. All depths 2" all-natural and deeper shall have anti-jamming design to prevent pans from sticking together. half, full, two-thirds, half-long, and third sizes shall have ramped sides for easy removal from wells. Reverse formed edge shall be flattened for consistent tangent to well opening and for hand comfort. Pans shall have an "all-natural-framing shoulder" on short sides around the interior body of the pan, accenting the food product and providing an appealing presentation. Pan size and capacity to be marked on all pans. NSF® certified. Meets Gastronorm (EN 631-1) standard.

Super Pan 3 Perforated Pans

- 22-gauge (.8 mm), 300 series stainless steel
- 5/32" (4 mm) holes drain quickly, but sized to retain most foods*
- Ideal for steaming foods or draining fats, juices, or moisture



PAN SIZE AND DIMENSIONS	ITEM #	DEPTH: IN (MM)	CASE LOT
 FULL-SIZE 20 ⁷ / ₁₆ x 12 ³ / ₁₆ in. 530 X 325 mm ¼	90013	1½ (40)	6
	90053	2 (55)	6
	90023	2½ (65)	6
	90043	4 (100)	6
	90063	6 (150)	6
 HALF-SIZE 12 ³ / ₁₆ x 10 ⁷ / ₁₆ in. 325 x 265 mm ½	90213	1½ (40)	6
	90223	2½ (65)	6
	90243	4 (100)	6
	90263	6 (150)	6
 THIRD-SIZE 6 ⁵ / ₁₆ x 12 ³ / ₁₆ in. 176 x 325 mm ⅓	90313	1½ (40)	6
	90323	2½ (65)	6
	90343	4 (100)	6
	90363	6 (150)	6

* For 1½", 2", and 2½", drain holes located in bottom only. For 4" all-natural and 6" all-natural, drain holes located in sides and bottom.

Super Pan 3[®] with Nonstick Interior

- SteelCoat x3™ nonstick coating, made without PFOA
- Dramatic black interior enhances both cold- and hot-food presentations
- Not for use with metal utensils
- Temperature tolerance of -20° to 450°F (-28° to 230°C)



PAN SIZE	ITEM #	DEPTH: IN (MM)	CAPACITY: QT (L)	CASE LOT
1/4	90017	1 1/2 (40)	5.7 (5.4)	6
1/4	90027	2 1/2 (65)	9 (8.5)	6
1/4	90047	4 (100)	14.2 (13.4)	6
1/2	90217	1 1/2 (40)	2.6 (2.4)	6
1/2	90227	2 1/2 (65)	4 (3.8)	6
1/2	90247	4 (100)	6.3 (6)	6
3/4	90527	2 1/2 (65)	3.9 (3.7)	6
3/4	90547	4 (100)	6 (5.7)	3
1/3	90327	2 1/2 (65)	2.5 (2.4)	6
1/3	90347	4 (100)	3.9 (3.7)	6
1/3	90367	6 (150)	5.8 (5.5)	6
1/3	90647	4 (100)	1.7 (1.6)	6

Super Pan 3 Cook-Chill Cover



- Stainless steel
- Specially designed for use in the cook-chill process
- Provides rapid, uniform chilling and rethermalization



PAN SIZE	ITEM #	CASE LOT
1/4	95100	12
1/2	95200	12
1/3	95300	12
1/6	95600	12

Super Pan 3 Flexible Pan Lids

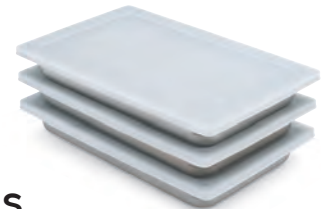

- Low-density polyethylene
- Translucent lids allow stacking for easy storage
- Sanitary and easy to clean
- Non-staining and dishwasher safe
- Safe to use in temperatures ranging from -20°F to 190°F (-28°C to 88°C)
- Ideal for cold food storage



PAN SIZE	ITEM #	CASE LOT
1/4	52430	6







PLASTIC PANS



Super Pan® High-Temperature Plastic Pans

- Temperature range is -40°F to 375°F (-40°C to 190.6°C)
- High-temperature resin
- Amber pans are translucent for content visibility
- For use in hot steam tables or microwaves
- Not recommended for use in ovens, combi-steamers, or convection ovens

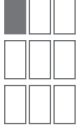

PAN SIZE AND DIMENSIONS	AMBER ITEM #	BLACK ITEM #	DEPTH IN (MM)	BRIMFUL CAPACITY QT (L)	PAN CASE LOT	AMBER SOLID COVER	AMBER SLOTTED COVER	AMBER FALSE BOTTOM	COVER CASE LOT
 FULL-SIZE 20¼ x 12¾ in. 530 x 325 mm ¼	9002410	9002420	2½ (65)	8.8 (8.3)	6	33100	34100	23100	6
	9004410	9004420	4 (100)	13.6 (12.9)	6	33100	34100	23100	6
	9006410	9006420	6 (150)	20.2 (19.2)	6	33100	34100	23100	6
	9008410	—	8 (200)	26.5 (25.1)	3	33100	34100	23100	6
 HALF-SIZE 10½ x 12¾ in. 265 x 325 mm ½	9022410	9022420	2½ (65)	3.9 (3.7)	6	33200	34200	23200	6
	9024410	9024420	4 (100)	5.9 (5.6)	6	33200	34200	23200	6
	9026410	9026420	6 (150)	8.6 (8.1)	6	33200	34200	23200	6
	9028410	—	8 (200)	11 (10.4)	3	33200	34200	23200	6
 HALF-LONG SIZE 20¼ x 6¼ in. 530 x 162 mm ¾	9052410	9052420	2½ (65)	3.8 (3.6)	6	33500	—	—	—
	9054410	9054420	4 (100)	5.7 (5.4)	3	33500	—	—	—
 THIRD-SIZE 6¾ x 12¾ in. 176 x 325 mm ⅓	9032410	9032420	2½ (65)	2.4 (2.3)	6	33300	34300	23300	6
	9034410	9034420	4 (100)	3.6 (3.4)	6	33300	34300	23300	6
	9036410	9036420	6 (150)	5.3 (5.1)	6	33300	34300	23300	6
	9038410	—	8 (200)	6.8 (6.5)	3	33300	34300	23300	6
 FOURTH-SIZE 6¾ x 10¾ in. 162 x 265 mm ¼	9042410	9042420	2½ (65)	1.8 (1.7)	6	33400	34400	23400	6
	9044410	9044420	4 (100)	2.7 (2.5)	6	33400	34400	23400	6
	9046410	9046420	6 (150)	3.8 (3.6)	6	33400	34400	23400	6
 SIXTH-SIZE 6¾ x 6¾ in. 176 x 162 mm ⅙	9062410	9062420	2½ (65)	1.1 (1)	6	33600	34600	23600	6
	9064410	9064420	4 (100)	1.6 (1.5)	6	33600	34600	23600	6
	9066410	9066420	6 (150)	2.2 (2.1)	6	33600	34600	23600	6
 NINTH-SIZE 6¾ x 4¼ in. 176 x 108 mm ⅑	9092410	9092420	2½ (65)	0.6 (0.6)	6	33900	—	—	6
	9094410	9094420	4 (100)	0.9 (0.9)	6	33900	—	—	6

For pan layouts, see page 94.







Specifications: Super Pan shall be constructed of polycarbonate (low temperature: -40°F to 210°F) or high-temperature resin (high temperature: -40°F to 375°F) material. Corner of top of flange shall be designed with built-in concave indentation for impact resistance. All depths shall have anti-jamming design to prevent pans from sticking together. Full, two-thirds, half, half-long, and third sizes shall have ramped sides for easy removal from wells. Reverse formed edge shall be flattened for consistent tangent to well opening and for hand comfort. Pans shall have an "all-natural-framing shoulder" around the interior body of the pan, accenting the food product and providing an appealing presentation. The low-temperature line is available in clear or black, and the high-temperature line is available in amber or black. Pan size and capacity to be marked on all pans. NSF® certified. Meets Gastronorm (EN 631-1) standard.



Super Pan® Low-Temperature Plastic Pans

- Temperature range is -40°F to 210°F (-40°C to 98.9°C)
- Polycarbonate construction
- Unique ramp
- Built-in, anti-jam stacking lugs
- Ideal for storage and cold applications
- Not for use in steam environments



PAN SIZE AND DIMENSIONS	CLEAR ITEM #	BLACK ITEM #	DEPTH IN (MM)	BRIMFUL CAPACITY QT (L)	PAN CASE LOT	CLEAR SOLID COVER	CLEAR SLOTTED COVER	CLEAR FALSE BOTTOM	COVER CASE LOT
 <p>FULL-SIZE 20% X 12% in. 530 x 325 mm ¼</p>	8002410	8002420	2½ (65)	8.8 (8.3)	6	31100	32100	29100	6
	8004410	8004420	4 (100)	13.6 (12.9)	6	31100	32100	29100	6
	8006410	8006420	6 (150)	20.2 (19.2)	6	31100	32100	29100	6
	8008410	—	8 (200)	26.5 (25.1)	3	31100	32100	29100	6
 <p>HALF-SIZE 10% x 12% in. 265 x 325 mm ½</p>	8022410	8022420	2½ (65)	3.9 (3.7)	6	31200	32200	29200	6
	8024410	8024420	4 (100)	5.9 (5.6)	6	31200	32200	29200	6
	8026410	8026420	6 (150)	8.6 (8.1)	6	31200	32200	29200	6
	8028410	—	8 (200)	11 (10.4)	3	31200	32200	29200	6
 <p>HALF-LONG SIZE 20% x 6% in. 530 x 162 mm ¾</p>	8052410	8052420	2½ (65)	3.8 (3.6)	6	31500	—	—	6
	8054410	8054420	4 (100)	5.7 (5.4)	3	31500	—	—	6
 <p>THIRD-SIZE 6% x 12% in. 176 x 325 mm ½</p>	8032410	8032420	2½ (65)	2.4 (2.3)	6	31300	32300	29300	6
	8034410	8034420	4 (100)	3.6 (3.4)	6	31300	32300	29300	6
	8036410	8036420	6 (150)	5.3 (5.1)	6	31300	32300	29300	6
 <p>FOURTH-SIZE 6% x 10% in. 162 x 265 mm ¼</p>	8042410	8042420	2½ (65)	1.8 (1.7)	6	31400	32400	29400	6
	8044410	8044420	4 (100)	2.7 (2.5)	6	31400	32400	29400	6
	8046410	8046420	6 (150)	3.8 (3.6)	6	31400	32400	29400	6
 <p>SIXTH-SIZE 6% x 6% in. 176 x 162 mm ⅙</p>	8062410	8062420	2½ (65)	1.1 (1)	6	31600	32600	29600	6
	8064410	8064420	4 (100)	1.6 (1.5)	6	31600	32600	29600	6
	8066410	8066420	6 (150)	2.2 (2.1)	6	31600	32600	29600	6
 <p>NINTH-SIZE 6% x 4% in. 176 x 108 mm ⅓</p>	8092410	8092420	2½ (65)	0.6 (0.6)	6	31900	—	—	6
	8094410	8094420	4 (100)	0.9 (0.9)	6	31900	—	—	6

For pan layouts, see page 94.

Specifications: Super Pan shall be constructed of polycarbonate (low temperature: -40°F to 210°F) or high-temperature resin (high temperature: -40°F to 375°F) material. Corner of top of flange shall be designed with built-in concave indentation for impact resistance. All depths shall have anti-jamming design to prevent pans from sticking together. Full, two-thirds, half, half-long, and third sizes shall have ramped sides for easy removal from wells. Reverse formed edge shall be flattened for consistent tangent to well opening and for hand comfort. Pans shall have an "all-natural-framing shoulder" around the interior body of the pan, accenting the food product and providing an appealing presentation. The low-temperature line is available in clear or black, and the high-temperature line is available in amber or black. Pan size and capacity to be marked on all pans. NSF® certified. Meets Gastronorm (EN 631-1) standard.



PAN LAYOUT TOOL

FOR SUPER PANS & SUPER SHAPES

ADAPTOR BAR REFERENCE

A variety of options for your 12" all-natural x 20" all-natural (30.5 x 50.8 cm) opening.

75020 

56680 

75013 

75012 

75015 



SPECIALTY PANS



Double-Wide Pans

Constructed of 22-gauge (.8 mm) stainless steel, Vollrath double-wide steam table pans are perfect for use in restaurants as well as colleges and universities. The increased size makes pans suited for use in high-volume operations.

- Pans are GN compliant for worldwide use
- Bright finish enhances presentation
- Available depths include: ¾", 1½", 2½" and 4"



ITEM #	DESCRIPTION	LENGTH/WIDTH: IN (CM)	DEPTH: IN (CM)	CAPACITY	CASE LOT
V210201	2/1 pan ¾" 20 mm steam table pan	25½" x 20½" (650 x 530 mm)	¾ 20 mm	6.6 qt 6.2 (L)	6
V210401	2/1 pan 1½" 40 mm steam table pan	25½" x 20½" (650 x 530 mm)	1½ 40 mm	12.6 qt 11.9 (L)	6
V210651	2/1 pan 2½" 65 mm steam table pan	25½" x 20½" (650 x 530 mm)	2½ 65 mm	19.9 qt 18.8 (L)	6
V211001	2/1 pan 4" 100 mm steam table pan	25½" x 20½" (650 x 530 mm)	4 100 mm	31.5 qt 29.8 (L)	5
V210202	2/1 perf pan ¾" 20 mm steam table pan	25½" x 20½" (650 x 530 mm)	¾ 20 mm	—	6

16" Deli Pans and Cover

- 24-gauge, 300 series stainless steel



ITEM #	DEPTH: IN (CM)	CAPACITY: QT (L)	CASE LOT	FLAT COVER ITEM #	COVER CASE LOT
FULL-SIZE PAN – 16⅞" x 9⅞" (41.5 X 25 CM)					
74262	2½ (65)	5 (4.7)	12	77150	6
74264	4 (100)	8½ (7.7)	12	77150	6
HALF-SIZE PAN – 9⅞" x 8⅞" (25 X 20.5 CM)					
75202	2½ (65)	2½ (2.3)	12	—	6
75204	4 (100)	4 (3.8)	12	—	6

Super Pan® with Handles

- Retractable handles let you lift and carry pans with ease
- Handles fit flush over the top edge for neat appearance and to help reduce steam release
- Handles are oven safe



PAN SIZE	ITEM #	DEPTH IN (MM)	BRIMFUL CAPACITY QT (L)	CASE LOT
1/1	30046	4 (100)	14 (13.3)	3
1/1	30066	6 (150)	21 (19.9)	3

Super Pan Cook-Chill Pans and Covers

- Stainless steel
- Specifically designed to provide rapid, uniform chilling and retherm for use in the cook-chill process
- Covers available with or without handles



PAN SIZE	ITEM #	DEPTH: IN (MM)	COVERED CAPACITY: QT (L)	UNCOVERED CAPACITY: QT (L)	CASE LOT	COVER W/OUT HANDLES	COVER WITH HANDLES	CASE LOT
¼	30020*	2½ (65)	6.6 (6.3)	8.3 (7.9)	6	77450	77350	12
½	30220*	2½ (65)	3.5 (3.3)	4.3 (4.1)	6	75450	—	12
⅓	30322**	2½ (65)	2.1 (2)	2.6 (2.5)	6	—	—	—

*20-gauge pan **22-gauge pan

Note: Portion control capacities are stamped on every pan for accurate yield

Note: Covers also fit Super Pan V Pans

Super Pan® Transport Pans

- Heavy-duty 20-gauge 300 series stainless steel
- Stepped-shoulder-designed pans with matching covers seal tightly to prevent seepage
- Securely stack together to reduce slipping during transport



ITEM #	DEPTH IN (MM)	CAPACITY: QT (L)		CASE LOT	PORTIONS TRANSPORTED			
		COVERED	UNCOVERED		2 OZ 60 ML	2½ OZ 75 ML	4 OZ 120 ML	8 OZ 235 ML
FULL-SIZE – 20¾" ALL-NATURAL X 12¾" ALL-NATURAL (527 X 324 MM)								
30015*	1¼ (35)	—	4 (3.8)	6	—	—	—	—
30025	2½ (65)	5 (4.7)	8 (7.6)	6	76	60	38	19
30045	4 (100)	10 (9.5)	14 (13.3)	6	161	120	80	40
30065	6 (150)	14 (13.3)	20 (19)	6	266	180	133	66
30088	8 (200)	22 (20.9)	28 (26.6)	4	400	300	200	100
HALF-SIZE – 10¾" ALL-NATURAL X 12¾" ALL-NATURAL (264 X 324 MM)								
30225	2½ (65)	2 (1.9)	4 (3.8)	6	32	24	16	8
30245	4 (100)	4 (3.8)	6 (5.7)	6	64	48	32	16
30265	6 (150)	7 (6.6)	10 (9.5)	6	112	84	56	28
30288	8 (200)	10 (9.5)	11 (10.4)	6	190	142	95	47

FOOD TRANSPORT COVERS** — SEAL SECURELY TO PREVENT SPILLAGE

ITEM #	DESCRIPTION	CASE LOT
70005	Full-size food transport cover	6
75025	One-half-size food transport cover	3

*Stacking lug is not incorporated in Item 30015 **Will only fit transport pans

Heavy-Duty Super Pan Steam Table Pans

- Heavy-duty 20-gauge, 300 series stainless steel with anti-jamming design
- Full- and half-size pans have reinforced corners for extra durability
- Flat edge and corners keep pans tight in well



Super Pan 2 corner design



Offset shoulder corner

PAN SIZE	ITEM #	DEPTH: IN (MM)	CAPACITY: QT (L)	CASE LOT	SOLID COVER	SLOTTED COVER	CASE LOT
SUPER PAN 2 CORNER DESIGN							
1/1	30020	2½ (65)	8.3 (7.9)	6	77250	75210	6
1/1	30040	4 (100)	14 (13.3)	6	77250	75210	6
1/1	30060	6 (150)	21 (19.9)	6	77250	75210	6
1/2	30220	2½ (65)	4.3 (4.1)	6	75120	75220	6
1/2	30240	4 (100)	6.7 (6.3)	6	75120	75220	6
1/2	30260	6 (150)	10 (9.5)	6	75120	75220	6
FLAT CORNER DESIGN							
1/1	S2008D	8 (203.2)	29¾ (28.2)	3	—	—	6
1/2 Long	S20062	2½ (63.5)	3½ (3.3)	6	—	—	6
1/2 Long	S20064	4 (101.6)	5¼ (5)	6	—	—	6
1/2 Long	S20066	6 (152.4)	9 (8.5)	6	—	—	6
1/2 Long	S1318D	8 (203.2)	14¾ (13.4)	3	—	—	—
1/3	S12062	2½ (63.5)	2¼ (2.1)	6	75130	75230	6
1/3	S12064	4 (101.6)	4½ (4.3)	6	75130	75230	6
1/3	S12066	6 (152.4)	6¾ (6)	6	75130	75230	6
1/4	S10062	2½ (63.5)	1¾ (1.5)	6	75140	75240	6
1/4	S10064	4 (101.6)	2¾ (2.7)	6	75140	75240	6
1/4	S10066	6 (152.4)	4¾ (4.1)	6	75140	75240	6
1/6	S06062	2½ (63.5)	1 (.9)	6	75160	75260	6
1/6	S06064	4 (101.6)	1¾ (1.8)	6	75160	75260	6
1/6	S06066	6 (152.4)	2¾ (2.5)	6	75160	75260	6
OFFSET SHOULDER DESIGN 18-GAUGE							
1/1	S2028D	8 (203.2)	30¾ (28.9)	4	—	—	—
1/2	S1328D	8 (203.2)	15 (14.2)	4	—	—	—

UNIVERSAL ACCESSORIES



NEW Pan Bands

SECURE PAN LIDS TO STEAM TABLE PANS WITH THESE HIGH-TEMPERATURE SILICONE BANDS

- Patented high-temperature silicone band (oven safe up to 450°F (223°C))
- Secures cover, polyfilm, or aluminum foil to pan for spill-resistant storage and transportation
- Dishwasher safe
- Easy to apply
- Available in black or gray

watch it on VOLLRATH.com



Visit VOLLRATH.com to view the Pan Bands product demo with Chef Rich.

ITEM #	DESCRIPTION	COLOR	DIMENSIONS (L X W X H): IN (CM)	CASE LOT
N-0001B	Full-size	Black	12 ³ / ₈ x 19 ⁵ / ₈ x 5 ¹ / ₈ (31.4 x 49.8 x 1.6)	24
N-0001G	Full-size	Gray	12 ³ / ₈ x 19 ⁵ / ₈ x 5 ¹ / ₈ (31.4 x 49.8 x 1.6)	24
N-0002B	Half-size	Black	12 ³ / ₈ x 10 ¹ / ₈ x 5 ¹ / ₈ (31.4 x 25.7 x 1.6)	24
N-0002G	Half-size	Gray	12 ³ / ₈ x 10 ¹ / ₈ x 5 ¹ / ₈ (31.4 x 25.7 x 1.6)	24
N-0003B	Third-size	Black	12 ³ / ₈ x 6 ¹ / ₂ x 5 ¹ / ₈ (31.4 x 16.5 x 1.6)	24
N-0003G	Third-size	Gray	12 ³ / ₈ x 6 ¹ / ₂ x 5 ¹ / ₈ (31.4 x 16.5 x 1.6)	24
N-0006B	Sixth-size	Black	6 x 6 ¹ / ₂ x 5 ¹ / ₈ (15.2 x 16.5 x 1.6)	24
N-0006G	Sixth-size	Gray	6 x 6 ¹ / ₂ x 5 ¹ / ₈ (15.2 x 16.5 x 1.6)	24

Egg Poachers

STAINLESS STEEL EGG POACHERS*

- Complete with pan, plate, cover, and lift-out aluminum poaching cups
- Can be used to hold juice glasses on cold buffet bar
- Hole diameter: 22³/₃₂" (6.9 cm)

NONSTICK EGG POACHER PAN

- 22-gauge stainless steel
- SteelCoat x3™ premium nonstick coating made without PFOA for easy cleanup



ITEM #	DESCRIPTION	CASE LOT
FULL-SIZE STAINLESS STEEL EGG POACHER		
75060	Full-size egg poacher/juice glass holder	1 set
75062	Replacement 15-hole plate	6
75080*	Replacement aluminum egg cups	12
ONE-HALF SIZE STAINLESS STEEL EGG POACHER		
75070	One-half size egg poacher/juice glass holder	1 set
75072	Replacement 8-hole plate	6
75080*	Replacement aluminum egg cups	12
75071	Replacement flat cover with knob	6
NONSTICK EGG POACHER PAN		
42100	20 ⁷ / ₈ x 12 ³ / ₁₆ x 1 ³ / ₁₆ (53 x 32.5 x 2), fits standard and Gastronorm full-size pans and hot or cold wells with 12" x 20" (30.5 x 50.8) opening	6
WEAR-EVER® EGG POACHER CUPS		
57900	Egg Poacher Cups, Non-Stick 3" (7.6 cm) top diameter, set of 12	1 set

*Imported item

PanaMax™ Dome Cover



- Patented low-profile design complements any chafer, serving line, or buffet application
- Durable ergonomic nylon handle is heat resistant up to 475°F (246°C)
- Mirror-finished stainless looks great and is easy to clean and maintain

ITEM #	DESCRIPTION	DIMENSIONS: IN (CM)	CASE LOT
49339	Full-size	21 x 13 x 4½ (53.3 x 33 x 11.4)	1

Solid Dome Cover



- Satin-finished, 300 series stainless steel
- Black Kool-Touch® handle stays comfortable to 220°F (104.4°C)
- Dome is 2½" (6.3 cm) high



ITEM #	DESCRIPTION	DIMENSIONS: IN (CM)	CASE LOT
77200	Full-size	21 x 12¾ x 3¾ (53.3 x 32.7 x 9.5)	1
77500	Half-size	12¾ x 10¾ x 3¾ (32.7 x 27 x 9.5)	1

Hinged Covers

- Stainless steel
- Convenient hinge allows easy access to food without having to remove entire cover



ITEM #	DESCRIPTION	DIMENSIONS: IN (CM)	CASE LOT
77430	Full-size – flat	20⅞ x 12¾ x ½ (53.2 x 32.7 x 1.3)	3
77400	Full-size – dome	21 x 12¾ x 2½ (53.3 x 32.7 x 6.4)	1

Cover-All™ Aluminum Covers

- Use in place of foil or plastic wrap to eliminate ongoing disposable costs
- Two half-size covers fit full-size pan
- Recessed for more secure stacking and nesting



Note: Not recommended as an alternative to stainless steel covers.

ITEM #	DESCRIPTION	DIMENSIONS: IN (CM)	CASE LOT
68020	Full-size	20¾ x 12¾ (52.7 x 32.4)	6
68010*	Half-size	10¾ x 12¾ (26.4 x 32.4)	3

*Two per full-size pan recommended

Super Pan® Cold Cover

- 300 series stainless steel
- Store in freezer overnight and use in place of standard transport covers to keep cold foods chilled



ITEM #	PAN SIZE	DIMENSIONS: IN (CM)	CASE LOT
70009	1/1	21 x 12⅞ x 1⅞ (53.3 x 32.9 x 2.4)	6

Cold cover will only fit Super Pan V® transport pans

Kool-Touch Clip-On Handle

- Insulated black handle clips onto the recessed handle on stainless steel stockpot covers, inset covers, bain marie covers, and steam table pan covers (down to sixth-size)

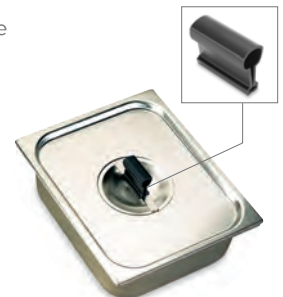

ITEM #	DESCRIPTION	DIMENSIONS: IN (CM)	CASE LOT
52970	Clip-on handle	2 x 7/8 x 1½ (5 x 2.2 x 4.1)	12

INSETS & BAIN MARIES



Stainless Steel Insets & Covers

- Satin-finished, 300 series stainless steel insets
- Insets nest together for compact storage when not in use
- Sharp radius between sleeves rests securely in opening without tipping
- Knob hinged – mirror-finished stainless steel covers have welded clips on stationary side to hold it securely in place, Kool-Touch® phenolic knob handle, and slot for ladle or spoon
- NEW Contemporary design option – mirror-finished stainless steel covers have permanently welded handle that serves as a kickstand with a large opening for easy access and slot for ladle and spoon



47490
Knob Hinged Cover



47493 Contemporary
Hinged Cover



NEW

ITEM #	CAPACITY QT (L)	FITS OPENING IN (CM)	DIAMETER X DEPTH IN (CM)	INSET CASE LOT	SLOTTED COVER ITEM #	SOLID** COVER ITEM #	SOLID COVER CASE LOT	KNOB HINGED COVER** ITEM #	KNOB HINGED COVER CASE LOT	CONTEMPORARY HINGED COVER** ITEM #	CONTEMPORARY HINGED COVER** CASE LOT
78154	2½ (2.4)	5 (12.7)	5½ x 7¾ (14.3 x 19.8)	6	78150*	79040	—	—	—	—	—
65S	3 (2.8)	6½ (16.5)	7½ x 5¼ (19 x 13.3)	6	78160*	—	—	47486*	6	—	—
78164	4½ (3.9)	6½ (16.5)	7¾ x 8¾ (18.9 x 20.8)	6	78160*	—	—	47486*	6	—	—
78174	4½ (3.9)	8½ (21.6)	9¾ x 4¾ (24 x 12.4)	6	78180*	77072	1	47488*	6	47493	1
78184	7¼ (6.9)	8½ (21.6)	9¾ x 8¾ (24 x 20.8)	6	78180*	77072	1	47488*	6	47493	1
78194	7¼ (6.9)	10½ (26.7)	11¾ x 5½ (28.7 x 14.3)	6	78200*	77112	1	47490*	6	47494	1
78204	11 (10.4)	10½ (26.7)	11¾ x 8¾ (28.7 x 20.8)	6	78200*	77112	1	47490*	6	47494	1

*Not NSF® certified **Stainless steel covers

Stainless Steel Bain Maries

- Satin-finished, 300 series stainless steel bain maries
- Sanitary open bead on edge
- Ideal for salad bar, dressing, and condiment service
- Recessed stainless steel covers for sanitary storage



ITEM #	CAPACITY QT (L)	FITS OPENING IN (CM)	OUTSIDE DIAMETER IN (CM)	DEPTH IN (CM)	OVERBEAD DIAMETER IN (CM)	BAIN MARIE CASE LOT	COVER ITEM #*	COVER CASE LOT
78710	1¼ (1.2)	4¼ (10.8)	4¾ (10.5)	5¾ (14.6)	4¾ (12.1)	6	79020	6
78720	2 (1.9)	5 (12.7)	4¾ (12.4)	6¾ (17.1)	5½ (14)	6	79040	6
78725	2 (1.9)	6¼ (15.9)	6¾ (15.6)	4 (10.1)	6¾ (17.1)	6	79080	6
78730	3½ (3.3)	6¼ (15.9)	6¾ (15.6)	7¼ (18.4)	6¾ (17.1)	6	79080	6
78740	4¼ (4)	6¾ (16.8)	6½ (16.5)	7¾ (19.4)	7¾ (18.1)	6	79100	6
78760	6 (5.7)	7¾ (18.7)	7¼ (18.4)	8¾ (21.9)	7¾ (20.2)	6	79120	6
78780	8¾ (7.8)	8¾ (20.6)	8 (20.3)	9¾ (24.5)	8¾ (22.2)	4	79170	4
78820	12 (11.4)	9¾ (23.2)	9 (22.9)	10¾ (27.6)	9¾ (24.8)	4	79220	4

*Stainless steel covers

ADAPTOR PLATES



ADAPTOR PLATES WORK IN CONJUNCTION WITH A WIDE VARIETY OF VOLLRATH'S PRODUCTS:

- Insets – Page 99
- Steam Table Pans – Pages 81-95
- Bain Maries – Page 99
- Sheet Pans – Pages 133-134

Sheet Pan Adaptor Plate

- 300 series stainless steel construction
- Accommodates both open and closed bead sheet pans of any gauge
- Allows food items to be warmed by either moist or dry heat



ITEM #	DESCRIPTION	CASE LOT
19199	Sheet pan adaptor plate for Signature Server®	1
19186	Two hot well sheet pan adaptor plates for drop-ins	1

Angled Adaptor Plates

- Elevates pans to enhance food presentation
- 300-series stainless steel construction

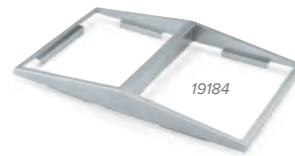

ITEM #	DESCRIPTION	DEGREE OF SLOPE	DIMENSIONS: IN (CM)	CASE LOT
19196	Single angled adaptor plate	6°	20 ⁷ / ₈ x 12 ³ / ₄ x 2 ¹ / ₈ (53 x 32.4 x 7.2)	2
19184	Dual-sided angled adaptor plate, holds two half-size pans	8.2°	20 ⁷ / ₈ x 12 ³ / ₄ x 2 ¹ / ₈ (53 x 32.4 x 5.4)	1

Adaptor Bars

- Mirror-finished 300-series stainless steel
- Fits standard opening for combination of smaller fractional pans
- T-shaped bar holds two fourth-size and one half-size pans
- Eliminates gaps to prevent steam loss and reduce energy consumption

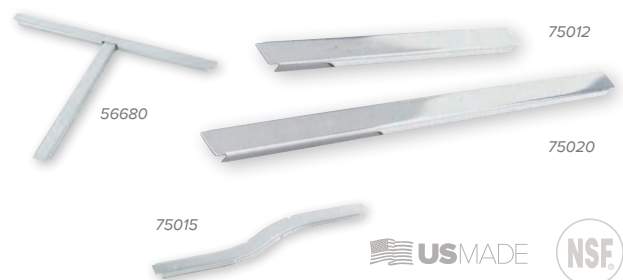

ITEM #	DIMENSIONS: IN (CM)	CASE LOT
75012	12 ⁵ / ₁₆ x 1 x 1/4 (32.9 x 2.5 x 0.6)	12
75020	20 ⁵ / ₁₆ x 1 x 1/4 (53.2 x 2.5 x 0.6)	12
56680	10 ³ / ₄ x 12 ³ / ₄ x 5/16 (27.3 x 32.3 x 0.8)	6
75013*	Adaptor bar for short wild pan, use with 3100220	12
75015	Adaptor bar for long wild pan, use with 3100020	12

Note: See pan layouts on page 94.

Adaptor Plate Cutout Dimensions



19194

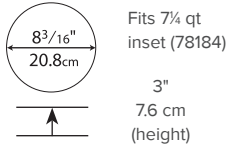

For use only with items 19192, 19188, and 19198 adaptor plates

19198

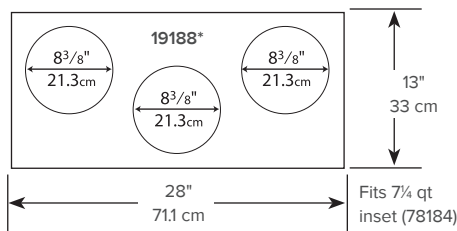
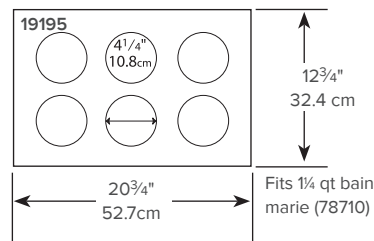
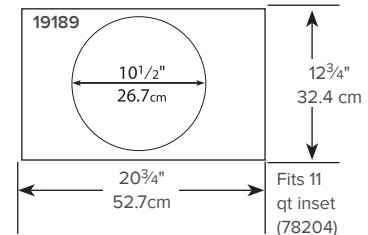
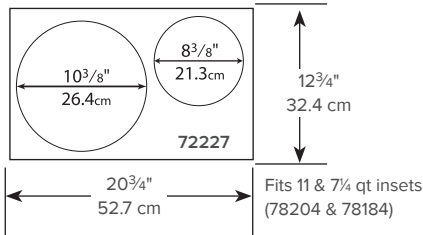
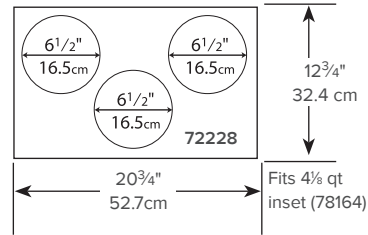
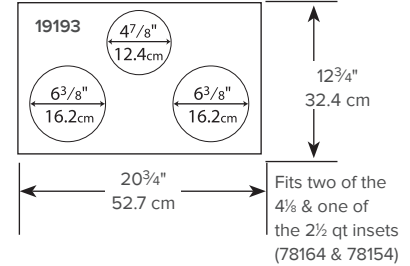
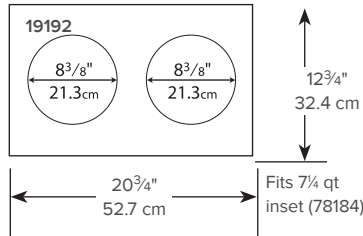
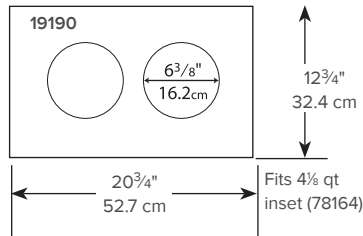
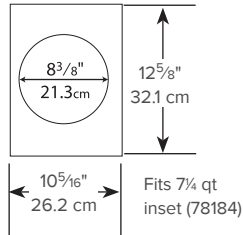

ITEM #	OPENINGS	CASE LOT
19190	With two 6 3/8" (16.2 cm) inset holes – fits 78164 (4½ qt/3.9 L)	4
19192	With two 8 3/8" (21.3 cm) inset holes – fits 78184 (7¼ qt/6.9 L)	4
19194	Adaptor ring fits 19192, 19188, and 19198 adaptor plates – fits 78184 (7¼ qt/6.9 L)	2
72227	With one 8 3/8" (21.3 cm) and one 10 3/8" (26.4 cm) inset holes – fits 78184 (7¼ qt/6.9 L) & 78204 (11 qt/10.4 L)	1
19193	With one 4 7/8" (12.4 cm) and two 6 3/8" (16.2 cm) inset holes – fits 78154 (2½ qt/2.4 L) & two 78164 (4½ qt/3.9 L)	4
72228	With three 6 1/2" (16.5 cm) inset holes – fits 78164 (4½ qt/3.9 L) – fits thermoset wells only	1
19188*	With three 8 3/8" (21.3 cm) inset holes – fits 78184 (7¼ qt/6.9 L) – for use with items 72050/72051	1
19195	With six 4 1/4" (10.8 cm) holes – fits 78710 (1¼ qt/1.2 L)	4
19189	With one 10 1/2" (26.8 cm) hole – fits 78204 (11 qt/10.4 L)	4
19198	With one 8 3/8" (21.3 cm) hole – fits 78184 (7¼ qt/6.9 L)	2

*Fits ½ rethermalizers and ¼ drop-ins only



COOKWARE & BAKEWARE

Get the superior performance and the durability you need for a busy kitchen with our cookware and bakeware lines.

[VOLLRATH.com/cookware](https://www.vollrath.com/cookware)

How to Shop

COOKWARE & BAKEWARE

Stainless Steel Cookware



With four distinct induction-compatible lines, you can choose the handle style, coating, and construction that fits your needs.

Pages 106-118



TRIBUTE®
Finest in Tri-Ply cookware

Pages 106, 107-109



CENTURION®
Double-rim cookware with European craftsmanship

Pages 106, 110-112



INTRIGUE®
Ergonomic, high-polished presentation cookware

Pages 106, 113-115



OPTIO™
Induction cookware for the cost-conscious chef

Pages 106, 116

MIRAMAR®
PRESENTATION
COOKWARE
& TEMPLATES

Page 189-197



Aluminum Cookware



Great for short-order cooks who need to heat food up quickly, aluminum pans are a lightweight and budget-conscious choice.

Pages 119-132



WEAR-EVER® CLASSIC SELECT®
HEAVY-DUTY COOKWARE

Pages 119-121



WEAR-EVER
CLASSIC ALUMINUM COOKWARE

Page 122-125



ALUMINUM FRY PANS

Page 125-128



SAUCE PANS & COVERS

Page 129-130



STIR FRY PANS

Page 131

Sheet Pans & Accessories



With the largest selection in the industry, Wear-Ever® impact-resistant, 3000 series aluminum sheet pans are a fundamental basic for every chef and bakers kitchen.

[Pages 133-135](#)



NSF SHEET PANS

[Page 133](#)



SHEET PAN COVERS

[Page 133](#)



NONSTICK SHEET PANS

[Page 134](#)



WIRE GRATES

[Page 135](#)

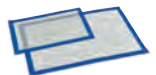

BAKING MATS

[Page 135](#)

Bakeware



Whether it's a cake, pie, or loaf pan meant to serve a few, or a heavy-duty roast pan designed to feed an army, Wear-Ever bakeware has the pans for you.

[Pages 132, 135-137](#)



COOKIE SHEETS

[Page 135](#)



CAKE & PIE PANS

[Page 137](#)



LOAF PANS

[Pages 136-137](#)



BAKE & ROAST PANS

[Page 136](#)



ALUMINUM ROASTERS

[Page 136](#)

GENERAL CARE AND USE

tips for all types of cookware

- Before using for the first time, remove all labels and wash in hot, soapy water to remove any manufacturing lubricants.
- Never leave cookware on heat source without food or liquid inside. Overheating in this manner may cause warping or delamination of metal layers and could void warranty.
- For safety and to prevent warping, allow cookware to cool before cleaning or immersing in water.
- Direct contact with salt can cause pitting. Add salt to boiling water to dissolve it.
- Salt solutions, acidic products like tomatoes, disinfectants, and bleaches can corrode cookware. Never store these items in cookware, and avoid prolonged exposure.
- All cookware will last longer and look better if washed by hand with hot, soapy water. Always scrub in the direction of the material grain. Rinse thoroughly and allow to air-dry completely.
- Use of plastic, wooden, or rubber utensils is recommended.
- If label adhesive remains on cookware, wipe off with WD-40 and clean with warm, soapy water.
- To remove white film caused by starch or water minerals, rub with sponge that has been dipped in lemon juice or vinegar; then wash with hot, soapy water.
- To remove food burnt to the bottom of cookware, boil a mild solution of vinegar and water for 10 minutes to dislodge food particles.

NONSTICK COATINGS (CERAMIGUARD[®], STEELCOAT X3[™], AND POWERCOAT2[™])

Allow nonstick coating to cool before cleaning. Hand-wash in hot, soapy water and dry immediately to preserve appearance. Use a non-woven scouring pad to remove burnt food. Avoid using abrasive cleaners, metal scouring pads, and strong solvents. When stacking pans, place liners between pans to avoid scratching nonstick surfaces. Note: Warranty is 90 days on all nonstick cookware.

CARBON STEEL COOKWARE

Pans are shipped with mineral oil applied to the pan. Wipe off oil and clean the pan using hot, soapy water. Dry immediately. After each use, clean and season. Wipe the inside and outside of the pan with unsalted cooking oil or shortening to prevent oxidation. The pan will turn a dark color as seasoning occurs after repeated use. Visit VOLLRATH.com for more detailed seasoning instructions.

REMOVING DISCOLORATION FROM ALUMINUM COOKWARE

Boil a solution of two tablespoons of cream of tartar to each quart of water in the cookware for 10 minutes.



Chef Rich demonstrates how to season your cast iron and carbon steel pans to avoid rust and keep food from sticking at VOLLRATH.com/season.



STAINLESS STEEL COOKWARE



13 YEARS
IN A ROW!

See the interactive cookware selection guide online at VOLLRATH.com/cookware.



TRIBUTE®
Pages 107-109



MIRAMAR®
Pages 189-197

















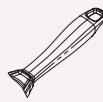















CENTURION®
Pages 110-112



INTRIGUE®
Pages 113-115



OPTIO™
Page 116

FEATURES	Tri-Ply construction creating perfect heat distribution, satin finish	Tri-Ply construction, satin bodies with polished handles (some pieces supplied in full polish finish)	Heavy-gauge stainless, satin finish with polished rim, and extra-large clad bottoms	Heavy-gauge stainless with large clad bottoms and mirror finish inside and out on most pieces	Easy-to-handle, lightweight stainless construction, mirror finish, clad bottom
MATERIAL	Tri-Ply stainless steel with aluminum core	Tri-Ply stainless steel with aluminum core	18-8 stainless steel with clad bottom	18-8 stainless steel with clad bottom	High-chrome stainless steel
HANDLE	 TriVent® natural  TriVent silicone	 Plated cast handle	 Hollow handle	 Hollow ergo handle	 Hollow handle
HANDLE ATTACHMENT	Ever-Tite™ rivets	Rivets	Welded, coated pans are riveted	Welded	Welded
USE	High-volume kitchens	Primarily display, but fully functional for high-volume kitchens	High-volume kitchens	High-volume kitchens, preferred for presentation cooking	Low- to medium-volume kitchens
PERFORMANCE LEVEL	★★★★★	★★★★★	★★★★★	★★★★★	★★★★★
PRICE	\$ \$ \$ \$	\$ \$ \$ \$	\$ \$ \$ \$	\$ \$ \$ \$	\$ \$ \$ \$
COATING	CeramiGuard® II (Made without PFOA)	Natural only	Nonstick (Made without PFOA)	CeramiGuard II (Made without PFOA)	Nonstick (Made without PFOA)
CERTIFICATION					
COMPATIBLE WITH	  	  	  	  	  
WARRANTY					90-day limited warranty



JACOB'S PRIDE® LIFETIME WARRANTY

TRIBUTE® 3-PLY COOKWARE

COOK ON FLAVOR-NEUTRAL 18-8 STAINLESS STEEL

Backed by a lifetime warranty and engineered to retain a precise combination of commercial strength and ergonomic characteristics, Vollrath's Tribute line has earned its reputation as one of the industry's top-performing cookware lines. The heavy-duty 18-8 non-corrosive stainless steel interior guarantees flavor neutrality and is surrounded by a layer of aluminum for even thermal distribution. The magnetic stainless steel outer layer makes Tribute a perfect choice for induction cooking. This exceptional cookware line includes Vollrath's TriVent® handle, an industry-leading handle known for durability and comfort, attached securely with the lifetime Ever-Tite™ Riveting System.

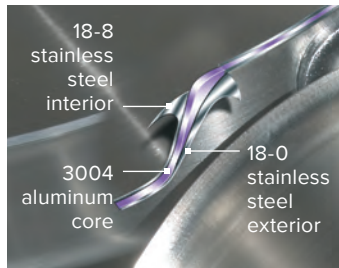

18-8 stainless steel interior does not affect color or flavors of food

3004 aluminum core provides even heat on bottom of pan and side walls

18-0 stainless steel exterior for durability and for use with gas, electric, or induction ranges

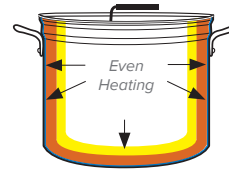

3-PLY COOKWARE

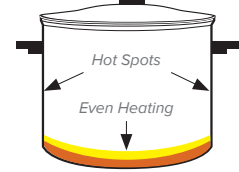

CONVENTIONAL COOKWARE

silicone handles and replacement handles



Oven-safe, cooler-to-the-touch silicone handles: 450° F (232° C) continuously, or up to 600° F (315° C) intermittently. See page 130 for replacement sleeves.



Tribute Fry Pans with TriVent Handle

- Ideal for frying, sautéing, or searing
- Available in Natural or with CeramiGuard® II nonstick interior, with plated or silicone handle



NATURAL FINISH SILICONE HANDLE	NATURAL FINISH PLATED HANDLE	CERAMIGUARD II SILICONE HANDLE	CERAMIGUARD II PLATED HANDLE	TOP DIA: IN (CM)	BOTTOM DIA: IN (CM)	HEIGHT: IN (CM)	GAUGE	CASE LOT	COVER ITEM #
69807	69207	69107	69607	7 (17.8)	4¾ (12.7)	1¼ (4.4)	10	6	69327
69808	69208	69108	69608	8 (20.3)	5¾ (14.6)	1½ (4.8)	10	6	69328
69810	69210	69110	69610	10 (25.4)	7¾ (19.4)	2½ (5.4)	8	6	69410
69812	69212	69112	69612	12 (30.5)	9¾ (24.8)	2½ (6.4)	8	2	69412
69814	69214	69114	69614	14 (35.6)	10¾ (27.6)	2¾ (7)	8	1	69414

Note: Jacob's Pride Warranty does not cover silicone on handle

Tribute Fry Pans with Purple Sleeve Handle

- Now available with purple handle for non-allergen cooking needs



NATURAL FINISH SILICONE HANDLE	CERAMIGUARD II SILICONE HANDLE	TOP DIA: IN (CM)	BOTTOM DIA: IN (CM)	HEIGHT: IN (CM)	GAUGE	CASE LOT	COVER ITEM #
693308	693208	8 (20.3)	5¾ (14.6)	1½ (4.8)	10	6	69328
693310	693210	10 (25.4)	7¾ (19.4)	2½ (5.4)	8	6	64910
693312	693212	12 (30.5)	9¾ (24.8)	2½ (6.4)	8	2	69412

Tribute® Sauciers



- Curved sides allow for thorough and efficient whisking of ingredients



ITEM #	CAPACITY QT (L)	DIAMETER: IN (CM)	DEPTH: IN (CM)	GAUGE	CASE LOT	COVER ITEM #
77790*	1 (0.9)	6½ (16.5)	2¼ (5.7)	10	1	—
77791	2 (1.9)	8 (20.3)	2½ (6.0)	8	1	69328
77792	3 (2.8)	10 (25.4)	3¼ (8.3)	8	1	69410

*Not induction ready
Note: Jacob's Pride® warranty does not cover silicone on handle

Tribute Sauce Pans



- Ideal for sauces, vegetables, rice, cereals, or soups



Helper Handle

ITEM #	CAPACITY QT (L)	DIAMETER: IN (CM)	DEPTH: IN (CM)	GAUGE	CASE LOT	COVER ITEM #
77739	1½ (1.4)	6 (15.2)	3 (7.6)	10	1	69325
77740	2½ (2.4)	7 (17.8)	3½ (8.9)	8	1	69327
77741	3½ (3.3)	8 (20.3)	4½ (10.5)	8	1	69328
77742	4½ (4.2)	9 (22.9)	4½ (10.5)	8	1	69329
77743*	7 (6.6)	10 (25.4)	5½ (13.7)	8	1	69410

*With helper handle
Note: Jacob's Pride warranty does not cover silicone on handle

Tribute Sauce/ Stock Pots



- Designed for preparing stocks, soups, and liquids or reducing liquids
- Tall and narrow shape allows liquids to bubble up through the food, extracting maximum flavor



ITEM #	CAPACITY QT (L)	DIAMETER: IN (CM)	DEPTH: IN (CM)	GAUGE	CASE LOT	COVER ITEM #
77780	4½ (4.2)	9 (22.9)	4½ (10.5)	8	1	69329
77519	6 (5.6)	9 (22.9)	5¼ (14.6)	8	1	69329
77520	8 (7.5)	10 (25.4)	6 (15.2)	8	1	69410
77521	12 (11.4)	12 (30.5)	6¼ (15.9)	8	1	69412
77522	16 (15.1)	12 (30.5)	8½ (21.6)	8	1	69412
77523	20 (18.9)	14 (35.6)	7¼ (19.7)	8	1	69414

Tribute Sauté Pans



- Tall sides minimize spattering
- Ideal for sautéing, stir-frying, and browning



Helper Handle

ITEM #	CAPACITY QT (L)	DIAMETER: IN (CM)	DEPTH: IN (CM)	GAUGE	CASE LOT	COVER ITEM #
77744	2 (1.9)	8 (20.3)	2½ (6.0)	8	1	69328
77745	3 (2.8)	10 (25.4)	2½ (6.0)	8	1	69410
77746*	6 (5.6)	12 (30.5)	2½ (6.8)	8	1	69412
77747*	7½ (7.1)	14 (35.6)	2½ (7.3)	8	1	69414

*With helper handle
Note: Jacob's Pride warranty does not cover silicone on handle

Tribute Covers

- 20-gauge stainless steel
- Welded all-natural antimicrobial dipped handle stays cool to the touch and is rated to 350 °F (176.6) °C
- Easy-grasp, 3¼" (9.4 cm) long handle design for safety and hanging convenience
- Pairs well with the Tribute stir fry pan – page 109



69410

ITEM #	DIAMETER: IN (CM)	CASE LOT
69325	6 (15.2) – fits 77739	1
69327	7 (17.8) – fits 69807, 69207, 69107, 77740, 69607	1
69328	8 (20.3) – fits 69808, 77744, 69208, 77791, 69108, 77741, 69608	1
69329	9 (22.9) – fits 77742, 77780, 77519	1
69410	10 (25.4) – fits 69810, 77520, 69210, 77792, 69110, 77743, 69610, 77745	1
69412	12 (30.5) – fits 69812, 77746, 69212, 77521, 69112, 77522, 69612, 77760	1
69414	14 (35.6) – fits 69814, 77523, 69214, 77747, 69114, 77761, 69614, 77754	1

Note: Jacob's Pride® warranty does not cover plastisol coating on handle

Tribute® Braziers

- Heavy-duty ergonomic handles with durable stainless rivets
- A great multi-use pot in any kitchen
- Wide heating surface is perfect for long, slow cooking of meats and vegetables in limited amounts of liquid



ITEM #	CAPACITY: QT (L)	DIAMETER: IN (CM)	DEPTH: IN (CM)	GAUGE	CASE LOT	COVER ITEM #
77760	10 (9.4)	12 (30.5)	5 ⁹ / ₃₂ (13.7)	8	1	69412
77761	15 (14.1)	14 (35.6)	5 ⁹ / ₃₂ (14.2)	8	1	69414

Tribute Stir Fry Pans

- Ideal for stir-frying or wok applications
- Flat bottom sits level on cooking surface
- Ever-Tite™ Riveting System offers lifetime warranty against loose rivets



ITEM #	CAPACITY: QT (L)	DIAMETER: IN (CM)	DEPTH: IN (CM)	GAUGE	CASE LOT	COVER ITEM #
77750	4 ³ / ₄ (4.5)	11 (27.9)	3 ¹ / ₂ (8.9)	8	1	—
77754	10 ³ / ₃₂ (9.6)	14 (36)	4 ³ / ₈ (11.1)	8	1	69414

Note: Jacob's Pride® warranty does not cover silicone on handle

Tribute Griddle with CeramiGuard® II Interior

- Ideal for grilled cheese sandwiches, quesadillas, french toast, pancakes, and eggs
- CeramiGuard II (made without PFOA) nonstick interior — triple-layer coating provides exceptional durability



ITEM #	DIMENSIONS: IN (CM)	GAUGE	CASE LOT
77530	12 (30) square	8	1

Note: Jacob's Pride Warranty does not cover silicone on handle or nonstick coatings

Stainless Steel Pasta Basket for Stock Pots

- Basket is 7" (18 cm) deep and intended for use in a 12 qt (11.4 L) stock pot, holds up to three servings (2.5 qt/2.3 L)
- Hole diameter: ³/₁₆" (0.5 cm)
- Four (4) baskets fit in Intrigue® pots 47732 & 47733 and Tribute pots 77521 & 77522



ITEM #	DESCRIPTION	GAUGE	CASE LOT
68134	Stainless steel pasta basket	22	1

CENTURION® COOKWARE

CRAFTED WITH THE FINEST STAINLESS STEEL IN THE EUROPEAN TRADITION WITH THICK, ALUMINUM-CLAD BOTTOM FOR QUICK, EVEN HEAT DISTRIBUTION



- Heavy-duty 18-8 (EU 18-10) brushed stainless steel construction will not pit, discolor, or retain flavors from previously cooked foods
- Welded handles are a single piece of hollow, airtight, waterproof stainless steel, and stay cooler to the touch
- ¼"-thick aluminum-clad bottom provides quick, even heat distribution
- Premier nonstick coating on fry pans is made without PFOA

Centurion Fry Pans

- Ideal for frying a variety of foods from tender eggs and fish to chicken pieces and pork chops



NATURAL FINISH ITEM #	NONSTICK ITEM #	TOP DIAMETER: IN (CM)	HEIGHT: IN (CM)	GAUGE	CASE LOT	DOMED COVER ITEM #
—	N3408	8 (20.3)	1½ (3.8)	20	1	3708C
3409	N3409	9½ (24.1)	1¾ (4.4)	18	1	3709C
3411	N3411	11 (27.9)	2¼ (5.7)	16	1	3711C
3412	N3412	12½ (31.8)	2½ (6.4)	16	1	3712C
3414*	N3414	14 (35.6)	2½ (6.4)	16	1	47777**

*Assist loop handle provided

**Universal cover for Centurion/Intrigue line

Centurion Sauté Pans



- Ideal for stir-frying, sautéing food in fat or liquid, browning vegetables, quick-stewing, and poaching



ITEM #	CAPACITY QT (L)	DIAMETER: IN (CM)	DEPTH: IN (CM)	GAUGE	CASE LOT	DOMED COVER ITEM #
3601	1½ (1.4)	6¾ (15.9)	2½ (6.4)	16	1	3706C
3602	2½ (2.4)	8 (20.3)	3¼ (8.9)	16	1	3708C
3604	4½ (4.3)	9½ (24.1)	3¾ (9.5)	14	1	3709C
3607*	7 (6.7)	11 (27.9)	4½ (11.4)	14	1	3711C

*Assist loop handle provided

Centurion Curved Saucier/ Sauté Pans



- Ideal for quick-cooking foods with a small amount of oil and high heat
- Perfect for browning meats and poultry, stir-frying, lightly browning vegetables, quick-stewing, and poaching



ITEM #	CAPACITY QT (L)	DIAMETER: IN (CM)	DEPTH: IN (CM)	GAUGE	CASE LOT	DOMED COVER ITEM #
3150	1¾ (1.7)	7 (17.8)	2¾ (7)	18	1	—
3151	2¼ (2.1)	7¾ (19.7)	3 (7.6)	18	1	3708C
3152	3¾ (3.1)	9½ (24.1)	3¾ (8.3)	16	1	3709C
3153	4¾ (4)	10½ (25.7)	3½ (8.9)	16	1	—

Centurion® French Omelet Pans



- Two-handled style with short, sloping sides is ideal for quick-cooking omelets and paella
- Curved sides allow food to be moved about quickly and easily



ITEM #	CAPACITY QT (L)	DIAMETER: IN (CM)	DEPTH: IN (CM)	GAUGE	CASE LOT	DOMED COVER ITEM #
3154	1¾ (1.7)	9½ (24.1)	1¾ (4.4)	18	1	3709C
3155	2¼ (2.1)	11 (27.9)	2½ (5.4)	16	1	3711C
3156	3¼ (3.1)	12½ (31.8)	2¾ (6)	16	1	3712C
3157	4¼ (4)	14 (35.6)	2¾ (6)	16	1	47777*

*Universal cover for Centurion/Intrigue line

Centurion Sauce Pans



- Ideal for cooking any food that has liquid in it, such as soup, vegetables, and sauces



ITEM #	CAPACITY QT (L)	DIAMETER: IN (CM)	DEPTH: IN (CM)	GAUGE	CASE LOT	DOMED COVER ITEM #
3702	2¼ (2.1)	6¼ (15.9)	4¼ (10.8)	16	1	3706C
3704	4¼ (4)	8 (20.3)	5¼ (13.3)	16	1	3708C
3707	7 (6.7)	9½ (24.1)	6 (15.2)	14	1	3709C

Centurion Stock Pots

- Ideal for preparing large quantities of liquids that are seasoned by beef, chicken, or vegetables. Also excellent for cooking pasta or bulky vegetables such as corn and artichokes or for steaming or boiling lobster



3106



ITEM #	CAPACITY: QT (L)	DIAMETER: IN (CM)	DEPTH: IN (CM)	GAUGE	CASE LOT	DOMED COVER ITEM #
3101	6½ (6.2)	8 (20.3)	8 (20.3)	16	1	3708C
3103	10½ (10)	9½ (24.1)	9½ (24.1)	14	1	3709C
3104	17½ (16.6)	11 (27.9)	11 (27.9)	14	1	3711C
3106	25½ (24.2)	12½ (31.8)	12½ (31.8)	14	1	3712C
3109	38 (36.1)	14 (35)	14 (35)	13	1	3713C
3113	53 (50.4)	15¾ (40)	15¾ (40)	13	1	3715C
3118	74 (70.3)	17¾ (45.1)	17¾ (45.1)	13	1	3717C

Centurion Sauce Pots

- Great for simmering soup, beans, and stews and for cooking pasta



ITEM #	CAPACITY: QT (L)	DIAMETER: IN (CM)	DEPTH: IN (CM)	GAUGE	CASE LOT	DOMED COVER ITEM #
3202	7 (6.7)	9½ (24.1)	6 (15.2)	14	1	3709C
3203	11½ (10.9)	11 (27.9)	7 (17.8)	14	1	3711C
3204	16¾ (15.9)	12½ (31.8)	7¾ (19.7)	14	1	3712C
3206	23 (21.9)	14 (35)	8½ (21.6)	14	1	3713C
3208	32¾ (31.1)	15¾ (40)	9½ (24.1)	13	1	3715C
3212	46¾ (44.4)	17¾ (45.1)	10¾ (27.3)	13	1	3717C

Centurion® Pasta Baskets

- Baskets add speed and convenience. Keep up to four types of pasta cooking at once. Lift, drain, and empty one insert at a time. Start a new batch immediately in the same hot water.
- Hang hook for easy draining
- Sauce pot sold separately



Hang Hook



ITEM #	DESCRIPTION	CASE LOT
3158	5½ qt (5.2 L) – fits 3206 sauce pot	1 (Set of 4)
3159	7½ qt (7.1 L) – fits 3208 sauce pot	1 (Set of 4)

Centurion Stainless Steel Braziers/Casseroles

- Ideal for slowly browning meat or vegetables in liquid



3310

ITEM #	CAPACITY: QT (L)	DIAMETER: IN (CM)	DEPTH: IN (CM)	GAUGE	CASE LOT	DOME COVER ITEM #
3304	4½ (4.3)	9½ (24.1)	3¾ (9.5)	14	1	3709C
3307	7 (6.7)	11 (27.9)	4½ (11.4)	14	1	3711C
3310	10½ (10)	12½ (31.8)	5 (12.7)	14	1	3712C
3315	15 (14.3)	14 (35)	5½ (13.3)	14	1	3713C
3320	20 (19)	15¾ (40)	6 (15.2)	13	1	3715C
3328	28½ (27.1)	17¾ (45.1)	6¾ (17.1)	13	1	3717C

Centurion Domed Covers

- Domed covers are designed to fit all Centurion stock pots, braziers/casseroles, sauce pots, sauce pans, sauté pans, and fry pans
- Spot-welded handles for strength and durability
- Domed cover allows moisture to condense and fall back onto food



3713C

ITEM #	DESCRIPTION	GAUGE	CASE LOT
3706C	6½" (16.5 cm) – fits 3601, 3702	18	1
3708C	8" (20.3 cm) – fits 3101, 3151, 3602, 3704, N3408	18	1
3709C	9½" (24.1 cm) – fits 3103, 3152, 3154, 3202, 3304, 3409, 3604, 3707, N3409	18	1
3711C	11½" (29.2 cm) – fits 3104, 3155, 3203, 3307, 3411, 3607, N3411	18	1
3712C	12½" (31.8 cm) – fits 3106, 3156, 3204, 3310, 3412, N3412	18	1
3713C	13½" (35 cm) – fits 3109, 3206, 3315	18	1
47777*	14" (35.6 cm) – fits 3157, 3414, N3414	18	1
3715C	15¾" (40 cm) – fits 3113, 3208, 3320	18	1
3717C	17¾" (45.1 cm) – fits 3118, 3212, 3328	18	1

*Universal cover for Centurion/Intrigue line



INTRIGUE® COOKWARE

HEAVY-GAUGE STAINLESS STEEL, LARGE CLAD BOTTOM, AND STUNNING MIRROR FINISH MAKE INTRIGUE THE GO-TO COOKWARE FOR PRESENTATION.

- Heavy-duty 18-8 (EU 18-10) mirror finish stainless steel construction
- Patented ergonomic handle designed for comfort, hollow centered handle stays cool, and riveted for durability
- Pots and braziers feature heavy-duty stainless steel loop handles
- Fry pans feature CeramiGuard® II, a nonstick coating made without PFOA – reduces need for cooking oil and cleans up easily
- Oven and dishwasher safe



Intrigue Stainless Steel Fry Pans

- Ideal for frying, scrambling, sautéing, or searing
- Great for use on 208V induction range
- 90-day warranty on CeramiGuard II nonstick coating



MIRROR FINISH ITEM #	CERAMIGUARD II ITEM #	TOP DIAMETER: IN (CM)	INSIDE DEPTH: IN (CM)	GAUGE	CASE LOT	COVER ITEM #
47750	47755	7 ³ / ₁₆ (20)	1 ¹ / ₁₆ (4.3)	18	1	47771
47751	47756	9 ³ / ₁₆ (24)	1 ³ / ₄ (4.5)	18	1	47773
47752	47757	10 ⁵ / ₁₆ (28)	1 ⁵ / ₁₆ (5)	18	1	47774
47753*	47758*	12 ¹ / ₂ (32)	2 ¹ / ₂ (6.4)	18	1	47776

*Includes helper handle
Note: Jacob's Pride warranty does not cover nonstick coatings

Intrigue Stainless Steel Sauce Pots

- Ideal for reducing liquids

Add speed and convenience to cooking noodles with a pasta basket. See pages 109 and 112 for details.



ITEM #	CAPACITY: QT (L)	INSIDE DIAMETER: IN (CM)	INSIDE DEPTH: IN (CM)	GAUGE	COVER ITEM #
47730	7 (6.6)	9 ³ / ₁₆ (24)	5 ³ / ₄ (14.8)	18	47773
47731	9 (8.5)	10 ⁵ / ₁₆ (28)	5 ¹ / ₂ (13.9)	18	47774
47732	12 (11.4)	11 ¹ / ₁₆ (30)	6 ⁵ / ₁₆ (16.2)	18	47775
47733	17 (16.1)	12 ¹ / ₂ (32)	7 ³ / ₁₆ (20.1)	16	47776
47734	24 (22.8)	14 ³ / ₁₆ (36)	9 (23)	16	47777
47735	33 (31.4)	15 ³ / ₁₆ (40)	9 ³ / ₄ (25)	16	47778

Intrigue® Stainless Steel Stock Pots

- Now available with double rim edge for extra strength and durability
- High-capacity stock pots have satin interior finish
- Designed for preparing stocks, soups, and liquids
- Tall and narrow shape allows liquids to bubble up through the food, extracting maximum flavor



ITEM #	CAPACITY: QT (L)	INSIDE DIAMETER: IN (CM)	INSIDE DEPTH: IN (CM)	GAUGE	COVER ITEM #
47720	6½ (6.1)	7⅜ (20)	7⅝ (20)	18	47771
47721	12 (11.4)	9⅜ (24)	9¾ (25)	18	47773
47722	18 (17)	10⅝ (28)	10⅝ (28)	18	47774
47723*	27 (25.5)	12½ (32)	12½ (32)	16	47776
47724*	38 (36)	14⅞ (35)	14⅞ (36)	16	4777735
47725*	53 (50.1)	15⅝ (40)	15⅝ (40)	16	47778
47726*	76 (71.9)	17⅝ (45)	16¾ (43)	16	4777945

*Satin-finished inside

Intrigue Stainless Steel Sauce Pans

- Ideal for sauces, vegetables, rice, cereals, or soups



ITEM #	CAPACITY: QT (L)	INSIDE DIAMETER: IN (CM)	INSIDE DEPTH: IN (CM)	GAUGE	COVER ITEM #
47740	2¼ (2.1)	7⅞ (18)	3⅝ (8.7)	18	47770
47741	3¼ (3.1)	7⅞ (20)	3⅞ (9.8)	18	47771
47742*	4¼ (4)	8⅞ (22)	4⅞ (10.6)	18	47772
47743*	7 (6.6)	9⅞ (24)	5¼ (14.8)	18	47773

*Includes helper handle

Intrigue Stainless Steel Sauciers

- Curved sides allow for thorough and efficient whisking of ingredients



ITEM #	CAPACITY: QT (L)	TOP DIAMETER: IN (CM)	INSIDE DEPTH: IN (CM)	GAUGE	COVER ITEM #
47790*	1 (0.9)	6¼ (16)	2¼ (5.7)	18	47780
47791	2 (1.9)	7⅞ (20)	2¾ (7.1)	18	47771
47792	3 (2.9)	9⅞ (24)	3 (7.6)	18	47773

*Not induction ready

Intrigue® Stainless Steel Sauté Pans

- Ideal for sautéing, stir-frying, and browning
- Tall sides minimize spattering



ITEM #	CAPACITY: QT (L)	INSIDE DIAMETER: IN (CM)	INSIDE DEPTH: IN (CM)	GAUGE	COVER ITEM #
47745	3 (2.8)	9 ³ / ₁₆ (24)	2 ¹ / ₂ (6.4)	18	47773
47746*	6 (5.7)	10 ⁵ / ₁₆ (28)	3 ⁵ / ₁₆ (9.3)	18	47774
47747*	9 ¹ / ₂ (9)	14 ¹ / ₁₆ (36)	3 ¹ / ₂ (8.9)	16	47777

*Includes helper handle

Intrigue Stainless Steel Braziers

- Perfect for long, slow cooking



ITEM #	CAPACITY: QT (L)	INSIDE DIAMETER: IN (CM)	INSIDE DEPTH: IN (CM)	GAUGE	COVER ITEM #
47760	12 (11.4)	14 ¹ / ₁₆ (36)	4 ³ / ₈ (11.3)	16	47777
47761	18 (17)	15 ⁵ / ₁₆ (40)	5 ⁵ / ₁₆ (13.7)	16	47778
47762	24 (22.7)	17 ⁵ / ₁₆ (46)	5 ⁵ / ₁₆ (13.7)	16	47779

Intrigue Stainless Steel Covers

- Mirror-finished inside, satin-finished outside



47779

ITEM #	NOMINAL DIAMETER: IN (CM)	HEIGHT OF HANDLE: IN (CM)	THICKNESS: IN (CM)	GAUGE	CASE LOT	ITEM #	NOMINAL DIAMETER: IN (CM)	HEIGHT OF HANDLE: IN (CM)	THICKNESS: IN (CM)	GAUGE	CASE LOT
47780	6 ⁵ / ₁₆ (16)	1 ¹ / ₁₆ (4.3)	¹ / ₁₆ (1.2)	18	1	47776	12 ⁵ / ₁₆ (32)	1 ³ / ₃₂ (5)	¹ / ₁₆ (1.2)	16	1
47770	7 ³ / ₃₂ (18)	1 ¹ / ₁₆ (4.3)	¹ / ₁₆ (1.2)	18	1	4777735	13 ³ / ₄ (35)	1 ³ / ₃₂ (5)	¹ / ₁₆ (1.2)	16	1
47771	7 ²⁹ / ₃₂ (20)	1 ¹ / ₁₆ (4.3)	¹ / ₁₆ (1.2)	18	1	47777	14 ⁷ / ₃₂ (36)	1 ³ / ₃₂ (5)	¹ / ₁₆ (1.2)	16	1
47772	8 ²⁹ / ₃₂ (22)	1 ¹ / ₁₆ (4.3)	¹ / ₁₆ (1.2)	18	1	47778	15 ²⁹ / ₃₂ (40)	1 ³ / ₃₂ (5)	¹ / ₁₆ (1.2)	16	1
47773	9 ⁹ / ₃₂ (24)	1 ¹ / ₁₆ (4.3)	¹ / ₁₆ (1.2)	18	1	4777945	17 ³ / ₄ (45)	1 ³ / ₃₂ (5)	¹ / ₁₆ (1.2)	16	1
47774	11 (28)	1 ³ / ₃₂ (5)	¹ / ₁₆ (1.2)	18	1	47779	18 ³ / ₃₂ (46)	1 ³ / ₃₂ (5)	¹ / ₁₆ (1.2)	18	1
47775	11 ¹³ / ₁₆ (30)	1 ³ / ₃₂ (5)	¹ / ₁₆ (1.2)	18	1	—	—	—	—	—	—



COOK WITH SAFETY AND STYLE

Tribute®, Centurion®, Intrigue®, and Optio™ cookware are ideal for use with Vollrath induction ranges. For more information on Vollrath induction ranges, see pages 29-32.

OPTIO™ COOKWARE



FOR THE VALUE-CONSCIOUS CHEF

- High-chrome stainless steel construction distributes heat quickly and will not pit, discolor, or carry flavors
- Aluminum-clad bottom provides quick and even distribution of heat
- Clad bottom is encapsulated by stainless steel to prevent denting and scratching
- Sauce pots, pans, and stock pots ship with domed covers



Optio Cookware Sets

ITEM #	DESCRIPTION	CASE LOT
3820	Deluxe 6-piece cookware set: 2.75 qt (2.6 L) sauce pan (3802) with lid (3907C), 4 qt (3.8 L) sauce pan (3803) with lid (3908C), 9.5" (24.1 cm) nonstick fry pan (N3809), stainless steel with lid (3910C)	1 set
3822	Deluxe 7-piece cookware set: 1 qt (.95 L) sauce pan (3800) with lid (3900C), 2.75 qt (2.6 L) sauce pan (3802) with lid (3907C), 6.75 qt (6.4 L) sauce pot (3902) with lid (3910C), 9.5" (24.1 cm) stainless steel fry pan (3809) (Note: The 3910C lid fits the 3809 fry pan).	1 set

Optio Fry Pans

- 90-day warranty on nonstick coating made without PFOA



NATURAL FINISH ITEM #	NONSTICK ITEM #	TOP DIA: IN (CM)	BOTTOM DIA: IN (CM)	HEIGHT: IN (CM)	GAUGE	CASE LOT	COVER ITEM #
—	N3817*	7 (17.8)	4¾ (13)	1¾ (4.4)	21	4	3907C
3808	N3808	8 (20.3)	5¾ (15)	1½ (3.8)	21	6	3908C
3809	N3809	9½ (24.1)	7¾ (19)	1¾ (4.4)	21	6	3910C
3811	N3811	11 (27.9)	9¾ (25)	2 (5.1)	21	2	3911C
3812	N3812	12½ (31.8)	10¾ (28)	2¼ (5.7)	21	2	3912C

*Not induction ready

Optio Sauce Pots, Pans, and Stock Pots

- Perfect for long, slow cooking



ITEM #	CAPACITY: QT (L)	DIAMETER: IN (CM)	DEPTH: IN (CM)	GAUGE	CASE LOT	COVER ITEM #	COVER DIAMETER: IN (CM)	COVER CASE LOT
SAUTÉ PANS								
3801	2½ (2.4)	8 (20.3)	3 (7.6)	21	2	3908C	8 (20.3)	6
3804	4 (3.8)	9½ (24.1)	4¼ (10.8)	21	2	3910C	9½ (24.1)	6
3807	6 (5.7)	11 (27.9)	3½ (8.9)	21	2	3911C	11 (27.9)	6
SAUCE PANS – SHIP WITH COVER								
3800	1 (.95)	5½ (14)	2¾ (7)	21	6	3900C	5½ (14)	12
3802	2¾ (2.6)	7 (17.8)	4¼ (10.5)	21	6	3907C	7 (17.8)	6
3803	4 (3.8)	8 (20.3)	4¾ (12.1)	21	6	3908C	8 (20.3)	6
3806	6¾ (6.4)	9½ (24.1)	6¾ (16.2)	21	6	3910C	9½ (24.1)	6
SAUCE POTS – SHIP WITH COVER								
3902	6¾ (6.4)	9½ (24.1)	6¾ (16.2)	21	2	3910C	9½ (24.1)	6
3903	10 (9.5)	11 (27.9)	7¾ (18.1)	21	2	3911C	11 (27.9)	6
3904	16 (15.2)	12½ (31.8)	8 (20.3)	21	2	3912C	12½ (31.8)	6
3905	22 (20.9)	14 (35.6)	8¾ (21.6)	21	2	3914C	14 (35.6)	6
STOCK POTS – SHIP WITH COVER								
3501	8 (7.6)	8½ (21.6)	8 (20.3)	21	2	3909C	8½ (21.6)	6
3503	11 (10.5)	9½ (24.1)	9½ (24.1)	21	2	3910C	9½ (24.1)	6
3504	18 (17.1)	11 (27.9)	11 (27.9)	21	2	3911C	11 (27.9)	6
3506	27 (25.7)	12½ (31.8)	12½ (31.8)	21	1	3912C	12½ (31.8)	6
3509	38 (36.1)	14 (35.6)	14¼ (36.2)	21	1	3914C	14 (35.6)	6
3513	53 (50.4)	15¾ (40)	15¾ (40.3)	18	1	3915C	15¾ (40)	6
BRAZIERS								
3810	10 (9.5)	12½ (31.8)	4½ (11)	21	2	3912C	12½ (31.8)	6
3814	14 (13.3)	14 (35.6)	5½ (14)	21	2	3914C	14 (35.6)	6
3819	19 (18.1)	15¾ (40)	6 (15.2)	18	1	3915C	15¾ (40)	6

Tri-Ply Stainless Steel Stock Pots

- Carbon steel core bonded within layers of 18-8 stainless steel, which cleans easily and will not react with food
- Solid welded stainless steel handles for durability and easy cleaning
- Liquid measure capacities chemically etched in quarts and liters on inside walls
- Ideal for stocks and storage



ITEM #	CAPACITY: QT (L)	DIAMETER: IN (CM)	DEPTH: IN (CM)	GAUGE	CASE LOT	COVER ITEM #
77560	10 (9.5)	10 (25.4)	8 ⁵ / ₁₆ (20.5)	18	1	77572*
77580	12 (11.4)	10 (25.4)	9 ¹ / ₂ (24.1)	18	1	77572*
77600	16 (15.1)	12 (30.5)	8 ¹ / ₂ (21.6)	16	1	77662*
77610	20 (18.9)	12 (30.5)	10 ⁵ / ₁₆ (26.8)	16	1	77662*
77620	24 (22.7)	12 (30.5)	12 ³ / ₈ (31.4)	16	1	77662*
77630	38 ¹ / ₂ (36.4)	14 (35.6)	15 (38.1)	16	1	77682*
77640	57 ¹ / ₂ (54.4)	16 (40.6)	17 (43.2)	16	1	77702*

*Covers sold separately **Covers are 22-gauge stainless steel

Stainless Steel Stock Pots and Storage Containers*

- 18-8 stainless steel
- Solid-welded stainless steel handles for durability and easy cleaning
- Feature an arc-sprayed aluminum bottom to distribute heat evenly



ITEM #	CAPACITY: QT (L)	DIAMETER: IN (CM)	DEPTH: IN (CM)	GAUGE	CASE LOT	COVER ITEM #
78560*	7 ¹ / ₂ (7.1)	8 ³ / ₈ (21.3)	8 ³ / ₄ (22.2)	24	1	77072**
78580*	11 ¹ / ₂ (10.9)	10 ³ / ₈ (26.4)	8 ¹ / ₂ (22.5)	20	1	77112**
78600*	16 (15.1)	12 ¹ / ₄ (31.1)	9 (22.9)	20	1	78672**
78610*	20 (18.9)	12 ¹ / ₄ (31.1)	11 (27.9)	20	1	78672**
78620*	24 (22.7)	12 ¹ / ₄ (31.1)	13 (33)	20	1	78672**
78630*	38 ¹ / ₂ (36.4)	13 ³ / ₈ (35.2)	15 ³ / ₄ (40)	20	1	78682**
78640*	60 (56.8)	16 (40.6)	18 (45.7)	18	1	78702**

*Not recommended for use on induction ranges **Covers sold separately ***Covers are 24-gauge stainless steel

Stainless Steel Double Boiler

- Straight handles with cover
- Ideal for melting chocolates or preparing delicate sauces
- 18-8 stainless steel
- Handle length: 6¹³/₁₆" (17.3 cm)
- Will not color delicate foods



ITEM #	DESCRIPTION	INSET CAPACITY: QT (L)	BODY CAPACITY: QT (L)	CASE LOT
77020*	Complete set includes cover	2 (1.9)	2 (1.9)	1

*Not recommended for use on induction ranges

Stainless Steel Double Boilers

- Complete set includes inset, pot, and cover
- 18-8 stainless steel with welded loop handles
- Ideal for delicate food preparation, reheating, preheating, and moisture-free cooking
- Conductive bottom distributes heat evenly



COMPLETE SET ITEM #	INSET CAPACITY: QT (L)	BODY CAPACITY: QT (L)	INSET OUTSIDE DIAMETER: IN (CM)	INSET AND POT HEIGHT: IN (CM)	INSET ONLY ITEM #	DEPTH: IN (CM)	INSET BOTTOM STYLE	GAUGE	POT ONLY ITEM #	GAUGE	SOLID COVER ITEM #	SLOTTED COVER ITEM #
77070	7 (6.6)	7½ (7.1)	9¾ (23.8)	11 (27.9)	77073*	8¾ (21.4)	Round	24	78560	24	77072	78180*
77110	11 (10.4)	11½ (10.9)	11¾ (29.1)	11 (27.9)	77113*	8¾ (22.2)	Flat	24	78580	20	77112	78200*
77130	20 (18.9)	20 (18.9)	12½ (32.5)	14 (35.6)	77133*	11 (10.4)	Flat	24	78610	20	78672	—

*Insets and slotted covers are not NSF® certified **Covers are 24-gauge stainless steel

Heavy-Duty Stainless Steel Tapered Sauce Pans

- Heavy-duty 18-8, 18-gauge stainless steel
- Ever-Tite™ riveting system provides for lifetime use without loose rivets



SILICONE HANDLE	PLATED HANDLE	CAPACITY: QT (L)	TOP DIA: IN (CM)	DEPTH: IN (CM)	HANDLE: IN (CM)	CASE LOT	COVER ITEM #	CASE LOT
78421*	78321*	2 (1.9)	7¼ (18.4)	3¾ (9.1)	6½ (16.5)	6	—	—
78431	78331	3 (2.8)	7½ (20.2)	4¾ (11.3)	6½ (16.5)	6	79120	6
78441	78341	4½ (4.3)	9¾ (24)	5¼ (13.3)	7¾ (19.7)	4	79220	4
78451	78351	5½ (5.2)	10¾ (25.7)	5¾ (14.3)	7¾ (19.7)	4	69410	1
78471* **	78371* **	7 (6.6)	10¾ (26.8)	6¼ (15.9)	11¼ (28.6)	4	—	—

*Cover not available **With helper handle

Carbon Steel Fry Pans

- Carbon steel conducts heat quickly and evenly
- Classic French style
- Permanently welded, balanced handle



See Chef Rich demonstrate how to season your cast iron and carbon steel pans at VOLLRATH.com/season.

ITEM #	TOP DIAMETER: IN (CM)	DEPTH: IN (CM)	GAUGE	CASE LOT
58900	8½ (21.6)	1¾ (4.4)	16	12
58910	9¾ (23.8)	1¾ (4.8)	16	6
58920	11 (27.9)	1¾ (4.9)	16	6
58930	12½ (31.8)	2½ (5.4)	16	6

Note: Covers not available

Induction Fry Pans with SteelCoat x3™ Interior

- Carbon steel conducts heat quickly and evenly
- SteelCoat x3™ premium nonstick coating, made without PFOA – easy cleanup, reduces use of fats and oils
- TriVent® bonded silicone handle rated at 450°F (232°C) for continuous use or 600°F (315°C) for intermittent use
- For use with conventional ranges or 120V induction ranges – 1.8 kW or less



ITEM #	TOP DIAMETER: IN (CM)	DEPTH: IN (CM)	GAUGE	CASE LOT
59900	8½ (21.6)	1¾ (4.4)	16	6
59910	9¾ (23.8)	1¾ (4.8)	16	6
59920	11 (27.9)	1¾ (4.9)	16	2

Note: Covers not available

ALUMINUM COOKWARE



13 YEARS
IN A ROW!

Learn more about the common materials used in cookware at VOLLRATH.com.



WEAR-EVER® CLASSIC SELECT®
PAGES 120-121



WEAR-EVER CLASSIC™
Pages 122

FEATURES	Primarily 2-gauge construction with double-thick bottom and top edge	Primarily 6- to 8-gauge construction, double-thick or rolled top edge
MATERIAL	Impact-resistant 3004 aluminum	Impact-resistant 3004 aluminum
HANDLE	<p>TriVent® natural TriVent silicone Nickel-plated steel</p>	<p>Nickel-plated steel w/Cool Handle® TriVent natural TriVent silicone</p>
HANDLE ATTACHMENT	Ever-Tite™ rivets with welded side handles	Ever-Tite™ rivets with welded side handles
USE	High-volume kitchens	Medium- to high-volume kitchens
PERFORMANCE LEVEL	★★★★★	★★★★☆
PRICE	\$ \$ \$ \$	\$ \$ \$ \$
COATING	-	-
CERTIFICATION	NSF	NSF
COMPATIBLE WITH		
WARRANTY		1-year warranty with lifetime warranty against loose rivets





WEAR-EVER® CLASSIC SELECT® ALUMINUM COOKWARE

- Double-thick bottoms heat evenly and eliminate hot spots
- Double-thick rims remain round for better cover fit
- Flat and domed covers available



Double-thick top stands up to tough knocks



Welded handles

Wear-Ever Classic Select Heavy-Duty Aluminum Stock Pots

- Designed for preparing stocks, soups, and liquids
- Tall and narrow shape allows liquids to bubble up through the food, extracting maximum flavor
- Solid-welded aluminum handles for durability and easy interior cleaning
- Available with heavy-duty faucets
- ¼" thick – 3004 aluminum



ITEM #	WITH FAUCET*	CAPACITY: QT (L)	INSIDE DIA: IN (CM)	INSIDE DEPTH: IN (CM)	GAUGE	CASE LOT	FLAT COVER**	DOMED COVER**
68616	—	15 (14.3)	10 (25.5)	11 $\frac{3}{8}$ (29.1)	2	1	67509	67409
68620	—	20 (18.9)	12 (30.6)	10 $\frac{3}{8}$ (26.5)	2	1	67521	67421
68624	—	25 (23.8)	12 (30.6)	13 $\frac{3}{8}$ (33.4)	2	1	67521	67421
68633	68631*	32 (30.3)	13 (33.2)	14 $\frac{3}{8}$ (36.7)	2	1	67533	67433
68640	68641*	40 (37.9)	14 (35.7)	15 (38.3)	2	1	67541	67441
68660	68661*	60 (56.8)	16 (40.8)	17 $\frac{1}{2}$ (44.6)	2	1	67561	67461
68680	68681*	80 (75.7)	18 (45.9)	18 $\frac{3}{8}$ (46.4)	2	1	67581	—
68690	68691*	100 (94.7)	20 (51)	19 (48.5)	2	1	67691	67491
68700	68701*	120 (113.6)	20 (51)	23 (58.7)	2	1	67691	67491

*Not NSF® certified – Jacob's Pride® warranty does not cover stock pots with faucets
Replacement items: 43933-2 screen, 44360-2 gasket kit, 23585-2 faucet, 23534-1 gasket kit

**Covers sold separately

Wear-Ever Classic Select Heavy-Duty Sauce Pots

- Ideal for reducing liquids
- Wider diameter and lower sides provide greater surface area for preparing soups, stews, and sauces
- Solid-welded aluminum handles for durability and easy interior cleaning



ITEM #	CAPACITY: QT (L)	INSIDE DIAMETER: IN (CM)	INSIDE DEPTH: IN (CM)	GAUGE	CASE LOT	FLAT COVER**	DOMED COVER**
68408	8 $\frac{1}{2}$ (8)	10 (25.5)	6 $\frac{1}{2}$ (16.6)	2	2	67509	67409
68413	12 (11.4)	12 (30.6)	6 $\frac{3}{8}$ (16.3)	2	2	67521	67421
68414	14 (13.3)	12 (30.6)	7 $\frac{3}{8}$ (18.9)	2	2	67521	67421
68420	20 (18.9)	13 (33.2)	9 (23)	2	2	67533	67433
68426	26 (24.7)	14 (35.7)	10 $\frac{1}{8}$ (25.8)	2	1	67541	67441
68434	34 (32.3)	16 (40.8)	10 $\frac{1}{8}$ (25.8)	2	1	67561	67461
68444	44 (41.8)	18 (45.9)	10 $\frac{3}{8}$ (26.5)	2	1	67581	67481
68460	60 (56.8)	20 (51)	11 $\frac{3}{8}$ (29.1)	2	1	67691	67491

*Covers sold separately

Wear-Ever® Classic Select® Heavy-Duty Aluminum Braziers

- Perfect for long, slow cooking
- Wide heating surface allows the cooking of meats and vegetables in limited amounts of liquid
- Solid-welded aluminum handles for durability and easy interior cleaning



68215



ITEM #	CAPACITY: QT (L)	INSIDE DIAMETER: IN (CM)	INSIDE DEPTH: IN (CM)	GAUGE	CASE LOT	FLAT COVER	DOMED COVER
68215	15 (14.3)	14 (35.7)	5½ (14.3)	2	1	67541	67441
68218	18 (17)	16 (40.8)	5½ (14.3)	2	1	67561	67461
68224	24 (22.7)	18 (45.9)	5½ (14)	2	1	67581	—
67228	28 (26.5)	20 (51)	5½ (14)	2	1	67691	67491

Wear-Ever Classic Select Heavy-Duty Straight-Sided Sauce Pans

- Ideal for sauces, vegetables, rice, cereals, or soups
- TriVent® bonded silicone handle rated at 450°F (232°C) for continuous use or 600°F (315°C) for intermittent use



Traditional Handle

Silicone Handle

Plated Handle



SILICONE HANDLE	PLATED HANDLE	TRADITIONAL HANDLE	CAPACITY: QT (L)	INSIDE DIAMETER: IN (CM)	INSIDE DEPTH: IN (CM)	GAUGE	CASE LOT	FLAT COVER	DOMED COVER
69442	69402	4107	2½ (2.4)	7¼ (18.5)	3¾ (9.2)	6	2	67327	67427
69444	69404	4108	4½ (4.3)	7¾ (19.9)	5¾ (14.8)	6	2	67312	67412
69446	69406	4109	6½ (6.2)	10 (25.5)	5 (12.8)	6	2	67509	67409
69448	69408	4110	8½ (8.1)	10 (25.5)	6½ (16.6)	6	1	67509	67409

Note: Jacob's Pride® warranty does not cover silicone on handle

Wear-Ever Classic Select Heavy-Duty Sauté Pans

- Ideal for sautéing, stir-frying, and browning
- TriVent bonded silicone handle rated at 450°F (232°C) for continuous use or 600°F (315°C) for intermittent use



Silicone Handle

Plated Handle

Traditional Handle



SILICONE HANDLE	PLATED HANDLE	TRADITIONAL HANDLE	CAPACITY: QT (L)	INSIDE DIAMETER: IN (CM)	INSIDE DEPTH: IN (CM)	GAUGE	CASE LOT	FLAT COVER	DOMED COVER
—	—	4068	2 (1.9)	8 (20.3)	2¾ (6.1)	8	2	67312	—
68733	68743	4070	3 (2.8)	10 (25.5)	2¾ (6.1)	6	2	67509	67409
68735	68745	4072	5 (4.7)	12 (30.6)	2¾ (6.9)	2	2	67521	67421
68737*	68747*	4074	7½ (7.1)	14 (35.7)	2¾ (6.6)	2	1	67541	67441

*Helper handle standard Note: Jacob's Pride warranty does not cover silicone on handle

WEAR-EVER® CLASSIC™ ALUMINUM COOKWARE



- Impact-resistant 3004 aluminum
- Heat is spread evenly along base and sidewalls
- Durable double-thick or rolled-rim designs remain round for long-lasting life and excellent cover fit
- Flat and domed covers available

Wear-Ever Classic Aluminum Stock Pots

- Designed for preparing stocks, soups, and liquids
- Tall and narrow shape allows liquids to bubble up through the food, extracting maximum flavor
- Solid-welded aluminum handles for durability and easy interior cleaning
- Beadless rims for easy cleaning
- Double-thick rim and bottoms resist denting



ITEM #	CAPACITY: QT (L)	INSIDE DIAMETER: IN (CM)	INSIDE DEPTH: IN (CM)	GAUGE	CASE LOT	FLAT COVER	DOMED COVER
67508	8½ (8)	10 (25.4)	6½ (16.5)	8	1	67509	67409
67510	10 (9.5)	10 (25.4)	7¾ (19.4)	8	1	67509	67409
67512	12 (11.4)	10 (25.4)	9 (22.9)	8	1	67509	67409
67516	16 (15.1)	10 (25.4)	12 (30.5)	8	1	67509	67409
67520	20 (18.9)	12 (30.5)	10½ (26.7)	8	1	67521	67421
67524	24 (22.7)	12 (30.5)	12¾ (30.9)	8	1	67521	67421
67532	32 (30.3)	13 (33)	14 (35.6)	8	1	67533	67433
67540	40 (37.9)	14 (35.6)	15 (38.1)	8	1	67541	67441
67560	60 (56.8)	16 (40.6)	17 (43.2)	6	1	67561	67461
67580	80 (75.7)	18 (45.7)	18¾ (46.4)	6	1	67581	—

Wear-Ever Classic Aluminum Sauce Pots

- Wider diameter and lower sides provide greater room for preparing soups, stews, and sauces
- Ideal for reducing liquids
- Solid-welded aluminum handles for durability and easy cleaning
- Beadless rims for easy cleaning
- Double-thick rim and bottoms resist denting



ITEM #	CAPACITY: QT (L)	INSIDE DIAMETER: IN (CM)	INSIDE DEPTH: IN (CM)	GAUGE	CASE LOT	FLAT COVER	DOMED COVER
67414	14 (13.3)	12 (30.5)	7½ (19.1)	8	2	67521	67421
67420	20 (18.9)	13 (33)	9 (22.9)	8	2	67533	67433
67426	26 (24.6)	14 (35.6)	10 (25.4)	8	2	67541	67441
67434	34 (32.2)	16 (40.6)	10 (25.4)	6	1	67561	67461

Wear-Ever Classic Rolled-Edge Stock Pots

- Extra-dent-resistant 3004 aluminum alloy
- Solid-welded aluminum handles for durability and easy cleaning
- Rolled edges maintain strength



ITEM #	CAPACITY: QT (L)	INSIDE DIAMETER: IN (CM)	INSIDE DEPTH: IN (CM)	GAUGE	CASE LOT	COVER
4302	9 (8.6)	9 (22.9)	8¾ (21.9)	8	2	67313
4303	12 (11.4)	10 (25.4)	9 (22.9)	8	2	67315
4305	20 (19)	12 (30.5)	10½ (26.7)	8	2	67521
4306	24 (22.8)	12 (30.5)	12½ (31.8)	6	1	67521
430712	30 (28.5)	13 (33)	13¾ (35.2)	6	1	67533
4310	40 (38)	14 (35.6)	15 (38.1)	6	1	67541
4315	60 (57)	16 (40.6)	18 (45.7)	6	1	67561
4320	80 (76)	18 (45.7)	18¾ (46.4)	6	1	67581

Wear-Ever® Rolled-Edge Sauce Pots

- Extra-dent-resistant 3004 aluminum alloy
- Rolled edges maintain strength
- Solid-welded aluminum handles for durability and easy cleaning



ITEM #	CAPACITY: QT (L)	INSIDE DIAMETER: IN (CM)	INSIDE DEPTH: IN (CM)	GAUGE	CASE LOT	COVER
4332	14 (13.3)	12 (30.5)	7½ (19.1)	8	2	67521
4333	20 (19)	13 (33)	9 (22.9)	6	2	67533
4334	26 (24.7)	14 (35.6)	10 (25.4)	8	2	67541

Wear-Ever Aluminum Sauté Pans

- Ideal for sautéing, stir-frying, and browning
- Tall side minimizes spattering, unlike a fry pan
- TriVent® bonded silicone handle rated at 450°F (232°C) for continuous use or 600°F (315°C) for intermittent use



SILICONE HANDLE	TRADITIONAL HANDLE	PLATED HANDLE	CAPACITY: QT (L)	INSIDE DIAMETER: IN (CM)	INSIDE DEPTH: IN (CM)	GAUGE	CASE LOT	FLAT COVER	DOMED COVER
67733	–	67133	3 (2.8)	10 (25.4)	2¾ (6)	10	2	67509	67409
67735	–	67135	5 (4.7)	12 (30.5)	2¾ (6.8)	8	2	67521	67421
67737	67437	67137	7½ (7.1)	14 (35.6)	2¾ (7.3)	8	2	67541	67441

Wear-Ever Egg Poacher

- Set complete with 8" natural-finish fry pan, Cool Handle®, silicone sleeve, inset, cups, and cover
- Quick-release cup surfaces with nonstick coating increase efficiency
- Replacement cups and covers available



For higher-volume poaching systems, see page 97.

ITEM #	DESCRIPTION	CASE LOT
56507	4-cup egg poacher set (includes pan, poacher insert, cups, and cover)	1
57900	Egg poacher cups – set of 12	12
57901	Egg poacher inset	3
67412	Replacement cover	1

Wear-Ever Shallow-Style Sauce Pans with Traditional Handle

- Double-thick top edges and bottoms for maximum life
- Ideal for making sauces and soups and for simmering and boiling foods in liquids



ITEM #	CAPACITY: QT (L)	INSIDE DIAMETER: IN (CM)	DEPTH: IN (CM)	GAUGE	CASE LOT	COVER
4018	2½ (2.4)	8 (20.3)	2¾ (5.4)	10	2	67312
4020	5 (4.8)	10 (25.4)	4 (10.2)	8	2	67315
4023	11½ (10.9)	13 (33)	5 (12.7)	8	1	67533

Wear-Ever® Aluminum Double Boilers

- Ideal for delicate food preparation, reheating, preheating, and moisture-free cooking
- Solid-welded aluminum handles for durability and easy interior cleaning
- Eliminates the need for constant stirring
- Ships complete with pot, inset, and cover



SET ITEM #	SECTION	CAPACITY: QT (L)	INSIDE DIAMETER: IN (CM)	INSIDE DEPTH: IN (CM)	CASE LOT	COMPONENT ITEM #
67708	Inset	8½ (8)	10 (25.4)	6¾ (17.5)	1	43047-2
	Pot	10 (9.5)	10 (25.4)	7¾ (19.4)	—	67510
	Cover	—	—	—	—	67509
67711	Inset	11 (10.4)	10 (25.4)	8¾ (22.4)	1	43048-2
	Pot	12 (11.4)	10 (25.4)	9 (22.9)	—	67512
	Cover	—	—	—	—	67509
67717	Inset	17½ (16.6)	12 (30.5)	9¾ (24)	1	43049-2
	Pot	20 (18.9)	12 (30.5)	10½ (26.7)	—	67520
	Cover	—	—	—	—	67521

Wear-Ever Pasta and Vegetable Cooker

- Set includes 18½ qt (17.5 L) 3004 aluminum pot and four perforated (¾" (0.5 cm) diameter holes) stainless steel inserts
- Baskets (3 qt/2.9 L) hold up to 3 servings of pasta
- TriVent® bonded silicone handle rated at 450°F (232°C) for continuous use or 600°F (315°C) for intermittent use
- Pots feature welded handles for easy cleanup and durability



ITEM #	DESCRIPTION	GAUGE	CASE LOT
68127	Pasta cooker set – complete	—	1
REPLACEMENT PARTS			
68130	Basket only	24	1
68129	Pot only – inside diameter 14" (35.6 cm), inside depth 7" (17.8 cm)	8	1

Wear-Ever Boiler/Fryer Sets

- Set includes pot, perforated basket with bail handle, and cover
- Bail handle for easy removal from pot and quick draining
- Ideal for boiling lobster, clams, shrimp, or fish, as well as deep-frying turkeys
- Replacement baskets are 3004 aluminum with bail handle, ¾" (1 cm) embossed feet, and ½" (1.3 cm) holes



SET ITEM #	CAPACITY QT (L)	POT INSIDE DIAMETER: IN (CM)	POT INSIDE DEPTH: IN (CM)	POT GAUGE	BASKET INSIDE DIAMETER: IN (CM)	BASKET INSIDE DEPTH: IN (CM)	BASKET MAX WIDTH AT BAIL: IN (CM)	COVER DIAMETER: IN (CM)	CASE LOT	REPLACEMENT BASKET ITEM #
68271	20 (18.9)	13¾ (33.2)	9 (22.9)	8	11¼ (28.6)	7¼ (18.4)	12½ (31.8)	13¾ (34.6)	1	68289*
68269	32 (30.3)	13¾ (33.2)	14 (35.6)	8	11¼ (28.6)	10¾ (27.6)	12½ (31.8)	13¾ (34.6)	1	68290*
68270	40 (37.9)	14 (35.6)	15¾ (38.3)	8	12½ (31.8)	11¾ (29.8)	13¾ (34.9)	14¾ (37.8)	1	68291*
68272	60 (56.8)	16¾ (42.5)	15¾ (40.3)	10	15½ (39.4)	11¾ (29.8)	16¾ (42.4)	17¾ (45.1)	1	68292*
68273	80 (75.7)	16¾ (42.5)	21¼ (54)	10	15½ (39.4)	16¾ (42.5)	16¾ (42.4)	17¾ (45.1)	1	68293*

*Not recommended for use with stainless steel pots

Wear-Ever® Fryers

- Heavy-duty 3004 aluminum pan with aluminum fryer basket
- Basket features a clip for easy draining and a long handle for easy removal from fryer
- Fryer pan has TriVent® plated handle and riveted helper handle
- Basket holes, 3/16" (0.5 cm), promote vigorous deep-fry action for crispier food
- Basket depth: 4" (10.2 cm)



COMPLETE SET ITEM #	CAPACITY: QT (L)	PAN INSIDE DIAMETER: IN (CM)	PAN INSIDE DEPTH: IN (CM)	PAN GAUGE	BASKET INSIDE DIAMETER: IN (CM)	BASKET DEPTH: IN (CM)	CASE LOT	COVER ITEM #	REPLACEMENT BASKET ITEM #
68227	9 (8.5)	12 (30.5)	4 ⁷ / ₈ (12.4)	10	11 (27.9)	4 (10.5)	1	67521*	43041
68228	12 (11.4)	14 (35.6)	4 ¹ / ₂ (11.4)	8	12 ³ / ₈ (32.7)	4 (10.5)	1	67541*	43042

*Cover for use with pot only

Stainless Steel Spaghetti Cooker/Strainer

- Welded stainless steel handle
- Helper hook attaches to side of pot
- Ideal for cooking and draining spaghetti portions



ITEM #	CAPACITY:	DEPTH: IN (CM)	DIAMETER: IN (CM)	CASE LOT
47960	3 qt, 11 oz (3.2 L)	4 (10.2)	8 ¹ / ₂ (21.6)	6

Wear-Ever Steamers/Cookers

- Sold as complete sets only
- 18-gauge 3004 aluminum
- Fit tightly together to retain the maximum steam heat
- Ideal for lightweight cooking applications



ITEM #	DESCRIPTION	SET COMES WITH	CAPACITY QT (L)	HEIGHT W/O COVER: IN (CM)	HEIGHT W/ COVER: IN (CM)	GAUGE	CASE LOT
68122	Rice/vegetable steamer	3-piece set with base, perforated section, and cover	3 (2.8)	8 ³ / ₈ (20.8)	11 ¹ / ₈ (28)	18	1
68123	Rice/vegetable steamer	3-piece set with base, perforated section, and cover	5 (4.7)	9 ³ / ₈ (23.3)	12 (30.5)	18	1
68125	3-tier vegetable steamer	4-piece set with base, two steamer trays, and cover	5 (4.7)	10 ⁵ / ₈ (26.2)	12 ⁵ / ₈ (31.3)	18	1
68126	Pasta cooker/vegetable steamer	4-piece set with high base pot, boiling basket, steamer insert w/bail handle, and cover w/vent	8 (7.6)	8 ³ / ₈ (20.8)	10 ¹ / ₄ (26)	18	1

ALUMINUM FRY PANS



13 YEARS
IN A ROW!

Visit VOLLRATH.com/cookware for more on the best cookware type for whatever you're preparing.











**WEAR-EVER®
RIVETLESS INTERIOR**
Page 128

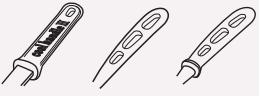

**WEAR-EVER
CLASSIC™**
Page 127



HARDCOAT®
Page 128

FEATURES	Primarily 8-gauge extra-hard aluminum, rivetless construction provides easy-to-clean body	Primarily 8-gauge aluminum construction, Ever-Tite™ rivets, three nonstick coating options	Primarily 8-gauge aluminum, anodized for warp resistance
MATERIAL	Impact-resistant 3004 aluminum	Impact-resistant 3004 aluminum	Impact-resistant 3004 aluminum
HANDLE	 Nickel-plated steel w/Cool Handle®	 Nickel-plated steel w/Cool Handle TriVent® natural TriVent silicone	 Nickel-plated steel w/Cool Handle
HANDLE ATTACHMENT	Rivetless construction	Ever-Tite™ rivets with a lifetime warranty	Aluminum rivets
USE	Medium- to high-volume kitchens	Medium- to high-volume kitchens	Medium- to high-volume kitchens
PERFORMANCE LEVEL	★★★★★	★★★★☆	★★★★☆
PRICE	\$\$\$	\$\$\$	\$\$\$
COATING	CeramiGuard® II, PowerCoat2™ (made without PFOA)	CeramiGuard II, SteelCoat x3™, PowerCoat2™ (made without PFOA)	Anodized finish
CERTIFICATION			
COMPATIBLE WITH			
WARRANTY	1-year warranty	1-year warranty with lifetime warranty against loose rivets	1-year warranty



Wear-Ever® Aluminum Fry Pans



VOTED BEST IN CLASS FOR 13 YEARS RUNNING

- Designed and built in the USA from extra-dent- and warp-resistant 3004 aluminum alloy
- Built for use in demanding commercial kitchens
- Available in natural finish or the best nonstick coatings in the industry, all made without PFOA – PowerCoat2™ (good), SteelCoat x3™ (better), and CeramiGuard® II (best)
- Fry pans are available in three handle styles – silicone Cool Handle®, TriVent® silicone handle, and TriVent plated handle
- Available with two silicone handle options rated at 450°F (232°C) for continuous use or 600°F (315°C) for intermittent use
- Replacement sleeves for Cool Handle and TriVent silicone-bonded handles restore handle comfort and performance to these hard-working pans
- Flat and domed covers are available

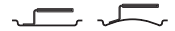

HANDLE	TOP DIA: IN (CM)	BOTTOM DIA: IN (CM)	HEIGHT: IN (CM)	GAUGE	CERAMIGUARD II ITEM #	STEELCOAT X3™ ITEM #	POWERCOAT2 ITEM #	NATURAL ITEM #	CASE LOT	FLAT COVER	DOMED COVER
Cool Handle	7 (17.8)	4¾ (12)	1½ (3.8)	8	Z4007	T4007	S4007	4007	6	67327	67427
Cool Handle	8 (20.3)	5¾ (14)	1¾ (4.8)	10	Z4008	T4008	S4008	4008	6	67312	67412
Cool Handle	10 (25.4)	7¾ (20)	2 (5.1)	8	Z4010	T4010	S4010	4010	6	67509	67409
Cool Handle	12 (30.5)	9¾ (25)	2¼ (5.7)	8	Z4012	T4012	S4012	4012	2	67521	67421
Cool Handle	14 (35.6)	10¾ (28)	2½ (6.4)	6	Z4014	T4014	S4014	4014	2	67541	67441
Silicone TriVent	7 (17.8)	4¾ (12)	1½ (3.8)	8	67927	67607	67807	67907	6	67327	67427
Silicone TriVent	8 (20.3)	5¾ (14)	1¾ (4.8)	10	67928	67608	67808	67908	6	67312	67412
Silicone TriVent	10 (25.4)	7¾ (20)	2 (5.1)	8	67930	67610	67810	67910	6	67509	67409
Silicone TriVent	12 (30.5)	9¾ (25)	2¼ (5.7)	8	67932	67612	67812	67912	2	67521	67421
Silicone TriVent	14 (35.6)	10¾ (28)	2½ (6.4)	6	67934	67614	67814	67914	2	67541	67441
Plated TriVent	7 (17.8)	4¾ (12)	1½ (3.8)	8	67947	67627	67007	67107	6	67327	67427
Plated TriVent	8 (20.3)	5¾ (14)	1¾ (4.8)	10	67948	67628	67008	67108	6	67312	67412
Plated TriVent	10 (25.4)	7¾ (20)	2 (5.1)	8	67950	67630	67010	67110	6	67509	67409
Plated TriVent	12 (30.5)	9¾ (25)	2¼ (5.7)	8	67952	67632	67012	67112	2	67521	67421
Plated TriVent	14 (35.6)	10¾ (28)	2½ (6.4)	6	67954	67634	67014	67114	2	67541	67441
PURPLE ALLERGEN HANDLES											
Purple allergen handle	7 (17.8)	4¾ (12)	1½ (3.8)	8	—	T400780	—	400780	6	67327	67427
Purple allergen handle	8 (20.3)	5¾ (14)	1¾ (4.8)	10	—	T400880	—	400880	6	67312	67412
Purple allergen handle	10 (25.4)	7¾ (20)	2 (5.1)	8	—	T401080	—	401080	6	67509	67409
Purple allergen handle	12 (30.5)	9¾ (25)	2¼ (5.7)	8	—	T401280	—	401280	2	67521	67421
Purple allergen handle	14 (35.6)	10¾ (28)	2½ (6.4)	6	—	T401480	—	401480	2	67541	67441

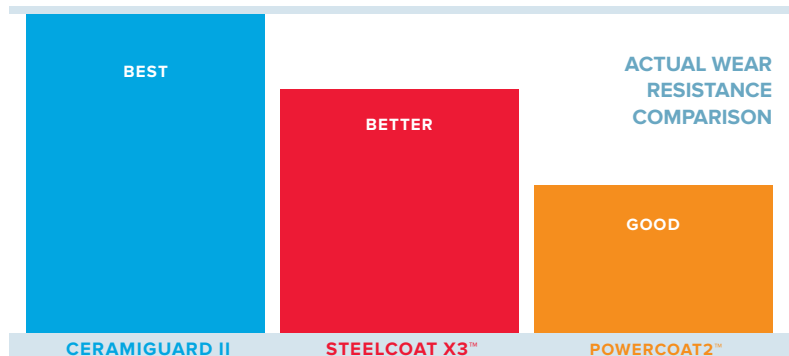

— watch it on VOLLRATH.com/rivet —

The **EXTREME HEAT** Test

00:24 MIN SEC

Vollrath 10" Aluminum Fry Pan with EverTite™ Rivets

See how Ever-Tite™ rivets stand up to 450° heat in the extreme heat test video at VOLLRATH.com/rivet.

Wear-Ever® Rivetless Interior Fry Pans

- Rivetless interior creates a smooth cooking surface, which helps eliminate food and bacteria traps
- Extra-dent-resistant 3004 aluminum alloy to ensure uniform side thickness, exceptional strength, and durability
- Available in three finishes
- Cool Handle® has excellent insulation from heat and is easily replaceable – see page 130



HANDLE	TOP DIA: IN (CM)	BOTTOM DIA: IN (CM)	HEIGHT: IN (CM)	GAUGE	CERAMIGUARD II ITEM #	POWERCOAT2™ ITEM #	NATURAL ITEM #	CASE LOT	FLAT COVER	DOMED COVER
Cool Handle	7 (17.8)	4¾ (12)	1½ (3.8)	8	EZ4007	ES4007	E4007	6	67327	67427
Cool Handle	8 (20.3)	5¾ (14)	1½ (4.8)	10	EZ4008	ES4008	E4008	6	67312	67412
Cool Handle	10 (25.4)	7¾ (20)	2 (5.1)	8	EZ4010	ES4010	E4010	6	67509	67409
Cool Handle	12 (30.5)	9¾ (25)	2¼ (5.7)	8	EZ4012	ES4012	E4012	2	67521	67421
Cool Handle	14 (35.6)	10¾ (28)	2½ (6.4)	6	EZ4014	ES4014	E4014	2	67541	67441

Wear-Ever Fry Pans with HardCoat® Strength

- HardCoat is a unique electro-chemical bonding process that unites the anodized surface with the aluminum base, creating a non-porous surface that is 400% harder than aluminum for warp resistance

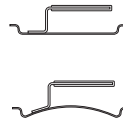

ITEM #	TOP DIA IN (CM)	BOTTOM DIA IN (CM)	HEIGHT IN (CM)	GAUGE	CASE LOT	FLAT COVER	DOMED COVER
H4007	7 (17.8)	4¾ (12)	1½ (3.8)	8	6	67327	67427
H4008	8 (20.3)	5¾ (14)	1½ (4.8)	10	6	67312	67412
H4010	10 (25.4)	7¾ (20)	2 (5.1)	8	6	67509	67409
H4012	12 (30.5)	9¾ (25)	2¼ (5.7)	8	2	67521	67421
H4014	14 (35.6)	10¾ (28)	2½ (6.4)	6	2	67541	67441

Aluminum Griddle

- SteelCoat x3™ premium nonstick coating, made without PFOA — easy cleanup, reduces use of fats and oils
- Riveted wire handle for convenient hanging
- 3004 aluminum



ITEM #	DESCRIPTION	DIAMETER: IN (CM)	GAUGE	CASE LOT
68530*	Aluminum griddle with SteelCoat x3™ nonstick and wire handle	12 (30.5)	8	6

*Not induction ready

SAUCE PANS & COVERS



Wear-Ever® Tapered Sauce Pans

- Designed and built in the USA from extra dent- and warp-resistant 3004 aluminum alloy
- Available with TriVent® silicone, TriVent chrome-plated steel, and Cool Handle®
- Ever-Tite™ Riveting System offers a lifetime warranty against loose rivets
- SteelCoat x3™ – premium nonstick coating made without PFOA
- Silicone handles rated at 450°F (232°C) for continuous use or 600°F (315°C) for intermittent use



Cool Handle®



Silicone TriVent Handle



Plated TriVent Handle

HANDLE	NATURAL ITEM #	STEELCOAT X3™ ITEM #	CAPACITY: QT (L)	TOP DIA: IN (CM)	BOTTOM DIA: IN (CM)	DEPTH: IN (CM)	GAUGE	CASE LOT	FLAT COVER	DOMED COVER
Cool Handle	434112	Z434112	1½ (1.4)	6 (15.2)	5¼ (13.3)	4 (10.2)	11	6	67311	67411
Cool Handle	434212	Z434212	2¾ (2.6)	7¾ (19.7)	6½ (16.5)	4¼ (10.8)	11	6	67312	67412
Cool Handle	434312	Z434312	3¾ (3.5)	8¾ (22.2)	7½ (18.1)	4½ (11.4)	11	6	67313	67413
Cool Handle	434412	Z434412	4½ (4.3)	9¼ (23.5)	7¾ (19.2)	5 (12.7)	11	6	67314	67424
Cool Handle	434512	—	5½ (5.2)	9¾ (25.1)	7¾ (19.4)	5½ (14)	11	6	67315	67409
Cool Handle	4347	—	7 (6.6)	10½ (27)	8¾ (21.9)	5½ (14.3)	11	6	67317	67417
Cool Handle	434812	—	8½ (8)	11¾ (28.7)	9¾ (24.8)	5¾ (14.6)	11	6	67318	—
Cool Handle	4350	—	10 (9.5)	12¾ (30.6)	10½ (26.7)	6¼ (15.9)	11	3	67320	67421
Silicone TriVent	68301	69301	1½ (1.4)	6 (15.2)	5¼ (13.3)	4 (10.2)	11	6	67311	67411
Silicone TriVent	68302	69302	2¾ (2.6)	7¾ (19.7)	6½ (16.5)	4¼ (10.8)	11	6	67312	67412
Silicone TriVent	68303	69303	3¾ (3.5)	8¾ (22.2)	7½ (18.1)	4½ (11.4)	11	6	67313	67413
Silicone TriVent	68304	69304	4½ (4.3)	9¼ (23.5)	7¾ (19.2)	5 (12.7)	11	6	67314	67424
Silicone TriVent	68305	69305	5½ (5.2)	9¾ (25.1)	7¾ (19.4)	5½ (14)	11	6	67315	67409
Silicone TriVent	68307*	69307*	7 (6.6)	10½ (27)	8¾ (21.9)	5½ (14.3)	11	6	67317	67417
Silicone TriVent	68308*	69308*	8½ (8)	11¾ (28.7)	9¾ (24.8)	5¾ (14.6)	11	6	67318	—
Silicone TriVent	68310*	69310*	10 (9.5)	12¾ (30.6)	10½ (26.7)	6¼ (15.9)	11	3	67320	67421
Plated TriVent	67301	—	1½ (1.4)	6 (15.2)	5¼ (13.3)	4 (10.2)	11	6	67311	67411
Plated TriVent	67302	—	2¾ (2.6)	7¾ (19.7)	6½ (16.5)	4¼ (10.8)	11	6	67312	67412
Plated TriVent	67303	—	3¾ (3.5)	8¾ (22.2)	7½ (18.1)	4½ (11.4)	11	6	67313	67413
Plated TriVent	67304	—	4½ (4.3)	9¼ (23.5)	7¾ (19.2)	5 (12.7)	11	6	67314	67424
Plated TriVent	67305	—	5½ (5.2)	9¾ (25.1)	7¾ (19.4)	5½ (14)	11	6	67315	67409
Plated TriVent	67307*	—	7 (6.6)	10½ (27)	8¾ (21.9)	5½ (14.3)	11	6	67317	67417
Plated TriVent	67308*	—	8½ (8)	11¾ (28.7)	9¾ (24.8)	5¾ (14.6)	11	6	67318	—
Plated TriVent	67310*	—	10 (9.5)	12¾ (30.6)	10½ (26.7)	6¼ (15.9)	11	3	67320	67421

*With helper handle

Wear-Ever® Covers for Aluminum Cookware



- 14-gauge 3004 aluminum
- Welded all-natural antimicrobial dipped handle stays cool to the touch and is rated to 350 F (176.6 C)
- Easy-grasp handle design for safety and hanging convenience
- Flat covers: Height with handle: 1 1/8" (4.1 cm)
- Domed covers: Deep satin finish

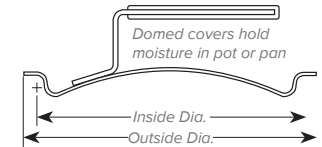
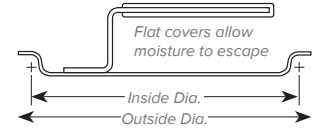

FLAT COVERS	OUTSIDE DIA: IN (CM)	INSIDE DIA: IN (CM)	HEIGHT W/ HANDLE: IN (CM)
67311	6 3/8 (16.8)	6 1/8 (15.4)	1 1/8 (4.1)
67327	7 1/8 (20)	7 1/8 (18.1)	1 1/8 (4.1)
67312	8 3/8 (21.1)	7 7/8 (20)	1 1/8 (4.1)
67313	9 3/8 (23.3)	8 3/8 (22.3)	1 1/8 (4.1)
67314	9 3/8 (24.9)	9 3/8 (23.6)	1 1/8 (4.1)
67315	10 1/2 (26.7)	9 3/8 (25)	1 1/8 (4.1)
67509	10 3/4 (27.3)	10 1/8 (25.7)	1 1/8 (4.1)
67317	11 1/8 (28.4)	10 3/8 (27.1)	1 1/8 (4.1)
67318	12 (30.5)	11 1/8 (29.1)	1 1/8 (4.1)
67320	12 3/8 (31.4)	11 3/8 (30.1)	1 1/8 (4.1)
67521	12 3/4 (32.4)	12 1/8 (30.7)	1 1/8 (4.1)
67533	13 3/8 (34.4)	13 1/8 (33.3)	1 1/8 (4.1)
67541	14 3/8 (37.8)	14 3/8 (36)	1 1/8 (4.1)
67561	17 1/8 (43.5)	16 1/4 (41.3)	1 1/8 (4.1)
67581	18 3/8 (47.9)	18 3/8 (46.1)	1 1/8 (4.1)
67691	20 3/8 (53)	20 3/8 (51.2)	1 1/8 (4.1)

DOMED COVERS	OUTSIDE DIA: IN (CM)	INSIDE DIA: IN (CM)	HEIGHT W/ HANDLE IN (CM)	CASE LOT
67411	6 3/8 (16.8)	5 7/8 (14.9)	2 1/8 (5.2)	1
67427	7 1/8 (20)	7 1/8 (18.1)	2 1/8 (5.2)	1
67412	8 3/8 (21.3)	7 1/2 (19.1)	2 1/8 (5.4)	1
67413	9 3/8 (23.8)	8 3/8 (21.6)	2 1/8 (5.4)	1
67424	10 (25.4)	8 3/4 (22.2)	2 1/8 (5.6)	1
—	—	—	—	1
67409	10 3/4 (27.3)	9 3/4 (24.8)	2 1/4 (5.7)	1
67417	11 1/8 (28.9)	10 1/2 (26.7)	2 3/8 (5.6)	1
—	—	—	—	1
—	—	—	—	1
67421	12 3/8 (32.7)	11 1/4 (29.8)	2 3/8 (5.8)	1
67433	13 3/8 (34.4)	13 1/8 (33.3)	2 3/8 (5.8)	1
67441	14 3/8 (37.8)	14 3/8 (36)	2 3/8 (6.2)	1
67461	17 1/8 (43.5)	16 1/4 (41.3)	2 3/8 (6.2)	1
—	—	—	—	1
67491	20 3/8 (53)	20 3/8 (51.2)	2 3/8 (6.5)	1

Replacement Handles

- Silicone insulating sleeve
- Oven safe to 450°F (232°C) continuously or 600°F (316°C) intermittently



Cool Handle® replacements



Purple silicone replacements

ITEM #	DESCRIPTION	LENGTH: IN (CM)	CASE LOT
TRIVENT® REPLACEMENTS			
6100*	Small TriVent sleeve, pack of 3	4 1/2 (11.3)	1
6101*	Medium TriVent sleeve, pack of 3	5 3/8 (13.7)	1
6102*	Large TriVent sleeve, pack of 3	6 1/8 (15.6)	1

*Display-ready 3-pack



Trivent replacements



Intended replacement



NOT intended for use over plain handle

ITEM #	DESCRIPTION	LENGTH: IN (CM)	CASE LOT
COOL HANDLE® REPLACEMENTS			
3011	Small Cool Handle III	4 (10.2)	12
3010	Medium Cool Handle II	4 1/2 (11.4)	12
3009	Large Cool Handle I	6 5/8 (16.8)	12
PURPLE SILICONE REPLACEMENT SLEEVES			
10815P	Medium Purple Replacement Sleeve	4 7/8 (11.3)	36
10816P	Large Purple Replacement Sleeve	5 1/8 (13.0)	36

Cool Handle replacements sold only in full-case packs of 12

STIR FRY PANS

Aluminum Stir Fry Pans

- TriVent® bonded silicone handle rated at 450°F (232°C) for continuous use or 600°F (315°C) for intermittent use
- 3004 aluminum
- SteelCoat x3™ premium nonstick coating made without PFOA – easy cleanup, reduces use of fats and oils



68120
*Not induction ready

ITEM #	DESCRIPTION	CAPACITY: QT (L)	DIAMETER: IN (CM)	DEPTH: IN (CM)	GAUGE	CASE LOT	DOMED COVER
68120*	Aluminum stir fry pan with SteelCoat x3™ nonstick and TriVent silicone handle	4½ (4.3)	11 (27.9)	3½ (8.9)	7	1	68121

Tribute® 3-Ply Stir Fry Pans

- Ideal for frying, sautéing, or searing
- Made from Tri-Ply stainless steel/aluminum core material
- Available in Natural or with CeramiGuard® II nonstick interior, with plated or silicone handle



77750

ITEM #	DESCRIPTION	CAPACITY: QT (L)	DIAMETER: IN (CM)	DEPTH: IN (CM)	GAUGE	CASE LOT	DOMED COVER
77750	Tribute stir fry pan with TriVent silicone handle	4¾ (4.5)	11 (27.9)	3½ (8.9)	8	1	—
77754	Tribute stir fry pan with TriVent silicone handle	10¾ (9.6)	14 (36)	4¾ (11.1)	8	1	—

Carbon Steel Stir Fry Pans

- Triple low-profile stainless rivets permanently attach handle to pan
- TriVent bonded silicone handle rated at 450°F (232°C) for continuous use or 600°F (315°C) for intermittent use
- SteelCoat x3™ premium nonstick coating made without PFOA – easy cleanup, reduces use of fats and oils



59950

ITEM #	DESCRIPTION	CAPACITY: QT (L)	DIAMETER: IN (CM)	DEPTH: IN (CM)	GAUGE	CASE LOT	DOMED COVER
59949	Carbon steel stir fry pan with silicone handle	4½ (4.3)	11 (27.9)	3½ (8.9)	18	1	68121
59950	Carbon steel stir fry pan with SteelCoat x3™ nonstick and silicone handle	4½ (4.3)	11 (27.9)	3½ (8.9)	18	1	68121

Wear-Ever® Stir Fry Pan with HardCoat® Interior

- HardCoat utilizes a unique electro-chemical bonding process that unites the anodized surface with the aluminum base, creating a non-porous surface that is 400% harder than aluminum
- Cool Handle® included



H4015
*Not induction ready

ITEM #	DESCRIPTION	DIAMETER: IN (CM)	DEPTH: IN (CM)	GAUGE	CASE LOT
H4015*	Wear-Ever stir fry pan with HardCoat interior	11½ (29.2)	4 (10.2)	10	1

Stir Fry Domed Cover

- Reduces splatters and speeds cooking
- Can be used on griddles to finish dishes



ITEM #	DESCRIPTION	DIA: IN (CM)	HEIGHT: IN (CM)	GAUGE	CASE LOT
68121	Domed cover fits Vollrath stir fry pan items 59950, 59949, and 68120 (does not fit item 77754 or 77750)	11 (27.9)	5 (12.7)*	12	1

*Height with handle

HEAVY-DUTY ROASTERS



Wear-Ever® Heavy-Duty Aluminum Roasters

- Extra-dent-resistant 3004 aluminum
- Standard roaster for military use
- Easy-to-grab loop handle on all four sides of pan
- Cover can be used as a griddle



ITEM #	PREVIOUS ITEM #	DESCRIPTION	CAPACITY: QT (L)	DIMENSIONS: IN (CM)	GAUGE	CASE LOT
68390	—	Pan with cover	42 (39.7)	21 $\frac{1}{2}$ x 18 $\frac{1}{2}$ x 9 (54.9 x 46 x 22.9)	4	1
68391	4493	Pan only	42 (39.7)	20 $\frac{7}{8}$ x 17 $\frac{3}{8}$ x 7 (53 x 44.1 x 17.8)	4	1
68392	4492	Cover only	14 (13.2)	21 $\frac{1}{2}$ x 18 $\frac{1}{2}$ x 2 $\frac{3}{8}$ (54.9 x 46 x 6)	4	1

Wear-Ever Aluminum Roasters



- Heavy-gauge 3004 aluminum with beadless rims
- When used as double roasters, sections fit snugly to seal in steam
- Loop handles
- Heats evenly and efficiently – recommend oven temperature by 25°F (-3.9°C) to reduce energy costs



ITEM #	PREVIOUS ITEM #	DESCRIPTION	CAPACITY: QT (L)	DIMENSIONS: IN (CM)	GAUGE	CASE LOT
68360*	—	Double roaster set top and bottom with straps	23 $\frac{3}{4}$ (22)	20 $\frac{1}{2}$ x 16 $\frac{1}{2}$ x 9 $\frac{3}{4}$ (51.1 x 41 x 24.8)	12	1
4482*	—	Strapped roast pan top for 68360	11 $\frac{1}{2}$ (10.8)	20 $\frac{1}{2}$ x 16 $\frac{1}{2}$ x 4 $\frac{1}{2}$ (51.1 x 41 x 11.4)	12	2
448212*	—	Strapped roast pan bottom for 68360	11 $\frac{1}{2}$ (10.8)	20 $\frac{1}{2}$ x 16 $\frac{1}{2}$ x 4 $\frac{1}{2}$ (51.1 x 41 x 11.4)	12	2
68361*	4483	Roasting pan – top with straps	29 $\frac{1}{2}$ (27.9)	24 x 18 x 4 $\frac{3}{4}$ (61 x 45.7 x 12.1)	10	2
68362*	448312	Roasting pan – bottom with straps	29 $\frac{1}{2}$ (27.9)	24 x 18 x 4 $\frac{3}{4}$ (61 x 45.7 x 12.1)	10	2
68363	4432	Roasting pan top for 68365	16 (15.1)	19 $\frac{3}{8}$ x 21 $\frac{1}{8}$ x 2 $\frac{3}{8}$ (50.3 x 55.4 x 6)	12	6
68364	4433	Roasting pan top for 68365	23 $\frac{1}{2}$ (22.2)	19 $\frac{3}{8}$ x 21 $\frac{3}{8}$ x 3 $\frac{3}{8}$ (50.3 x 55.4 x 9.2)	12	2
68365	4436	Roasting pan bottom for 68363, 68364	42 $\frac{1}{2}$ (40.2)	22 $\frac{1}{2}$ x 20 $\frac{1}{2}$ x 6 $\frac{1}{8}$ (56.2 x 51.1 x 16.6)	10	2
68366	4423	Roasting pan top for 68367	11 $\frac{1}{4}$ (10.6)	19 $\frac{3}{4}$ x 10 $\frac{7}{8}$ x 3 $\frac{3}{8}$ (50.2 x 27.6 x 9.2)	14	2
68367	4426	Roasting pan bottom for 68366	17 $\frac{3}{4}$ (16.8)	20 x 11 $\frac{1}{2}$ x 5 $\frac{1}{2}$ (50.8 x 28.3 x 14)	12	2

*Not NSF® certified



SHEET PANS & ACCESSORIES

THE INDUSTRY'S TOP-SELLING SHEET PANS

- Chosen more often than any other sheet pan in the industry, Wear-Ever® 3000 series aluminum alloy sheet pans set the standard for dent resistance, easy-cleaning properties, and even heat distribution. Proven to be 20% stronger than competing sheet pans.
- Bead styles:

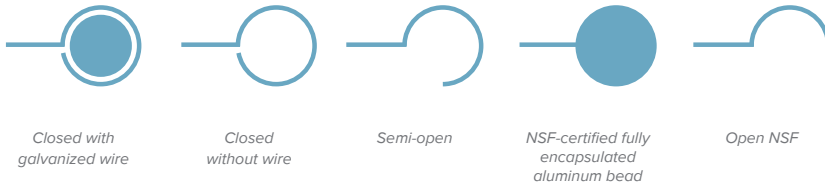

Visit VOLLRATH.com for facts about the characteristics of sheet pan material.

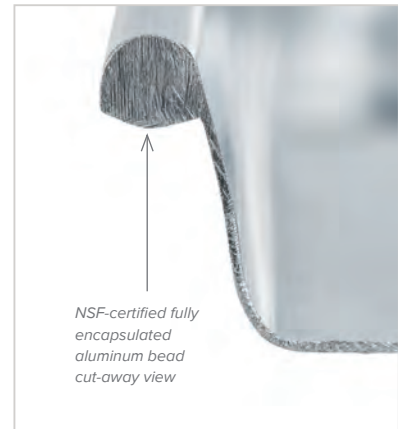

Wear-Ever NSF Sheet Pans

- Fully encapsulated aluminum bead prevents rust and provides excellent strength without unnecessary weight
- One-metal construction, along with the rigid nature of the pans, helps pans maintain their structural integrity while in the oven
- Fully recyclable
- Base material is 3000 series aluminum
- Concave bottom flattens during heating for even heat distribution
- Pans fit with the full line of sheet pan accessories, including baking mats, wire grates, and sheet pan covers
- Patent pending



ITEM #	DESCRIPTION	GAUGE	BEAD DESCRIPTION	DIMENSIONS (W X D X H): IN (CM)	CASE LOT	COVER ITEM
935303	Half-size sheet pan	18	Fully encapsulated aluminum bead	18 x 13 x 1 (45.1 x 32.7 x 2.5)	12	5303CV
939002	Full-size sheet pan	18	Fully encapsulated aluminum bead	18 x 26 x 1 (45.1 x 65.4 x 2.5)	12	9002CV
939001	Full-size sheet pan	16	Fully encapsulated aluminum bead	18 x 26 x 1 (45.1 x 65.4 x 2.5)	6	9002CV

NEW Sheet Pan Cover



- Clear polypropylene provides great food visibility
- Stacking lugs for strength and rigidity

ITEM #	SIZE	DIMENSIONS: IN (CM)	CASE LOT
9002CV*	Full	18 x 26 x 1 (45.7 x 66.0 x 2.5)	12
5303CV	Half	18 x 13 x 1 (45.7 x 33.0 x 2.5)	12
5220CV	¼	9½ x 13 x 1 (24.1 x 33 x 2.5)	12

*9002CV will not fit 5315 or S5315

Wear-Ever Party Pan



- Impact-resistant 3004 aluminum
- Ideal for brownies, jelly rolls, or other baked favorites



ITEM #	DIMENSIONS: IN (CM)	GAUGE	CASE LOT
68100	15½ x 10½ x 1 (39.4 x 26.7 x 2.5)	18	6

Wear-Ever® Heavy-Duty Sheet Pans

- Impact-resistant 3000 series aluminum
- Tapered design for easy stacking
- Galvanized non-rusting rod reinforces closed bead pan
- Concave bottoms flatten during heating for even heat distribution
- Nonstick pans made without PFOA

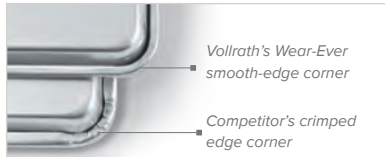

ITEM #	SIZE	GAUGE		BEAD DESCRIPTION	DIMENSIONS: IN (CM)	CASE LOT
5315	Full	12		Open bead, natural, NSF® CERTIFIED	18 x 26 x 1 (45.1 x 65.4 x 2.54)	6
S5315	Full	12		Open bead, nonstick, NSF CERTIFIED	18 x 26 x 1 (45.1 x 65.4 x 2.54)	6
N5300	Full	14		Closed bead with galvanized wire, natural	18 x 26 x 1 (45.1 x 65.4 x 2.54)	12
9001	Full	16		Closed bead with galvanized wire, natural	18 x 26 x 1 (45.1 x 65.4 x 2.54)	12
9002	Full	18		Closed bead with galvanized wire, natural	18 x 26 x 1 (45.1 x 65.4 x 2.54)	12
9002P	Full	18		Closed bead with galvanized wire, natural perforated	18 x 26 x 1 (45.1 x 65.4 x 2.54)	12
9003	Full	19		Closed bead with galvanized wire, economy	18 x 26 x 1 (45.1 x 65.4 x 2.54)	12
5223	Two-thirds	18		Closed bead with galvanized wire, natural	15 x 21 x 1 (38.1 x 53.3 x 2.5)	12
5314	Half	13		Open bead, natural, NSF CERTIFIED	18 x 13 x 1 (45.1 x 32.7 x 2.54)	12
5303	Half	18		Closed bead with galvanized wire, natural	18 x 13 x 1 (45.1 x 32.7 x 2.54)	12
S5303	Half	18		Closed bead with galvanized wire, nonstick	18 x 13 x 1 (45.1 x 32.7 x 2.54)	6
5303P	Half	18		Closed bead with galvanized wire, natural perforated	18 x 13 x 1 (45.1 x 32.7 x 2.54)	12
9303	Half	19		Closed bead with galvanized wire, economy	18 x 13 x 1 (45.1 x 32.7 x 2.54)	12
5220	Quarter	16		Closed bead, natural	9½ x 13 x 1 (24.1 x 33 x 2.54)	12
S5220	Quarter	16		Closed bead, nonstick	9½ x 13 x 1 (24.1 x 33 x 2.54)	12
5228	Eight	16		Semi-open bead, natural	9½ x 6½ (24.1 x 16.5)	12

Wear-Ever Nonstick Sheet Pans

- 18-gauge 3000 series aluminum with galvanized steel reinforcing rod
- Proteins, starches, and the typical sweets remove easily, reducing cleaning time so pans pay for themselves over and over in commercial kitchens
- Coating provides excellent wear and durability properties
- Designed for baking operations up to 450°F (232°C)
- Now available in perforated style



ITEM #	DESCRIPTION	GAUGE		BEAD DESCRIPTION	DIMENSIONS (W X D X H): IN (CM)	CASE LOT
9002NS	Full	18		Closed bead with galvanized wire	18 x 26 x 1 (45.1 x 65.4 x 2.5)	12
9002NSP	Full perforated	18		Closed bead with galvanized wire	18 x 26 x 1 (45.1 x 65.4 x 2.5)	12
5303NS	Half	18		Closed bead with galvanized wire	18 x 13 x 1 (45.1 x 32.7 x 2.5)	12
5303NSP	Half perforated	18		Closed bead with galvanized wire	18 x 13 x 1 (45.1 x 32.7 x 2.5)	12
5220NS	Quarter	16		Closed bead	9½ x 13 x 1 (24.1 x 33 x 2.54)	12

Stainless Steel Wire Grates



- The only stainless steel wire grates available in the industry
- Heavy-duty 300 series stainless steel wire construction minimizes rust without any plating that can flake off
- Ample finger room for easy removal from pan
- Use as a roasting, cooling, icing, display, or drying rack
- Oven safe

ITEM #	SIZE	DIMENSIONS: IN (CM)	CASE LOT
20038	Full	24 x 16½ x 7⁄8 (61 x 41.9 x 2.2)	6
20248	Half	16½ x 11¾ x 7⁄8 (41.9 x 29.8 x 2.2)	6

See the Steam Table Pans section for more wire grate options.

Silicone Baking Mats

- Nonstick for quick, easy cleanup

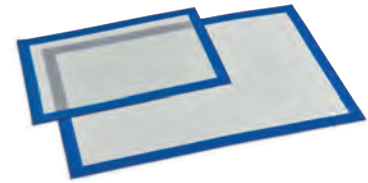

ITEM #	SIZE	DIMENSIONS: IN (CM)	CASE LOT
T3610SM	Full	23¾ x 15¾ (60.0 x 40.0)	12
T3605SM	Half	16⅝ x 11 (42.2 x 27.9)	12



BAKEWARE

Wear-Ever® Cookie Sheets

- Heavy-gauge 3004 aluminum heats rapidly and evenly
- Available in natural-finish aluminum or coated with SteelCoat x3™ (made without PFOA) premium nonstick for easy release of delicate baked goods



ITEM #	FINISH	DIMENSIONS: IN (CM)	GAUGE	CASE LOT
68085	Natural	17 x 14 (43.2 x 35.6)	10	6
68084	SteelCoat x3™	17 x 14 (43.2 x 35.6)	10	6

Wear-Ever Professional Cheesecake Pans

- 3000 series aluminum, natural finish
- Ideal for puddings, soufflés, cobblers, and casseroles, as well as cheesecake
- Straight sides are designed to produce uniform pieces



ITEM #	DIMENSIONS: IN (CM)	GAUGE	CASE LOT
5274	17¾ x 25¾ x 3 (45.1 x 65.4 x 7.6)	12	2
5275	17¾ x 12⅞ x 3 (45.1 x 32.7 x 7.6)	12	2



Handles lift and lower for ease of use and storage

Wear-Ever® Bake & Roast Pans

- Extra-dent-resistant, heavy-duty, impact-resistant 3004 aluminum
- Solid welded aluminum handles for durability and easy cleaning



ITEM #	PREVIOUS ITEM #	HANDLES	CAPACITY: QT (L)	DIMENSIONS: IN (CM)	GAUGE	CASE LOT
SATIN FINISH W/TAPERED SIDES						
4412	—	Yes	4½ (4.3)	9¾ x 13¼ x 2¼ (24.8 x 33.7 x 5.7)	16	6
4457	—	Yes	12½ (11.9)	23 x 12½ x 2¾ (58.4 x 32.1 x 7)	12	6
68257	4415	Yes	7½ (7.1)	17½ x 11¾ x 2⅞ (44.8 x 29.9 x 6.2)	14	6
68357*	5312	No	15 (14.2)	25¾ x 17¾ x 2¼ (65.4 x 45.1 x 5.7)	12	6
68358*	5313	Yes	23½ (22.2)	25¾ x 17¾ x 3⅞ (65.4 x 45.1 x 9.1)	12	4
68250	4414	Yes	5⅝ (5.1)	10⅞ x 15⅞ x 2¼ (27.6 x 40.3 x 5.7)	12	3
68251	—	Yes	11⅞ (10.5)	16¾ x 13 x 3⅝ (42.5 x 33 x 9.2)	14	3
68252	4458	Yes	17⅞ (16.9)	24 x 14 x 3½ (60.9 x 35.6 x 8.9)	12	3
68253	4456	Yes	8⅝ (8.5)	22⅞ x 13½ x 2 (58.1 x 34.3 x 5.1)	14	3
ECONOMY						
68078	—	Yes	6¼ (5.9)	15⅝ x 10⅞ x 2⅝ (39.1 x 27.6 x 6)	18	3
68080	—	Yes	7½ (7.1)	17⅞ x 11¾ x 2⅝ (44.8 x 29.9 x 6)	16	3
68076	4410	No	3⅞ (3.7)	9 x 13 x 2¼ (22.9 x 33 x 5.7)	18	3
POLISHED/NATURAL FINISH WITH STRAIGHT SIDES						
68369	—	Yes	8⅞ (7.7)	18⅞ x 12⅞ x 2⅞ (47.2 x 31.9 x 5.4)	14	3
51066	—	No	3⅜ (3.3)	12¾ x 9 x 2 (32.4 x 22.9 x 5.1)	20	6

*NSF certified

Stainless Steel Bake and Roast Pans

- 18-8 stainless steel
- Standard sizes for most commercial applications



ITEM #	CAPACITY: QT (L)	DIMENSIONS: IN (CM)	GAUGE	CASE LOT
61230	3½ (3.3)	14⅞ x 10¼ x 2 (37.8 x 26 x 5.1)	22	3
61250	4¾ (4.5)	16⅞ x 11⅞ x 2¼ (41 x 28.3 x 5.7)	22	3
61270	6½ (6.2)	18⅞ x 12⅞ x 2⅝ (46 x 31.4 x 6)	22	3

Stainless Steel Loaf Pans

- 300 series stainless steel



ITEM #	DIMENSIONS: IN (CM)	GAUGE	CAPACITY: QT / LB	CASE LOT
4V	8¾ x 4⅝ x 3⅞ (22.2 x 11.7 x 7.9)	22	1¼ / 3½	12
72060	10⅞ x 5½ x 4 (26.4 x 14 x 10.1)	22	3 / 6	6

Wear-Ever® Professional Standard Strength Loaf Pans

- 3000 series aluminum
- Sanitary and easy to clean
- Available in natural, nonstick, and anodized finishes



ITEM #	FINISH	DIMENSIONS: IN (CM)	CAPACITY: LB (KG)	GAUGE	CASE LOT
5431	Natural	3½ x 5 x 2½ (8.6 x 12.7 x 6.4)	1 (.45)	12	12
5436	Anodized	4½ x 8¾ x 2¾ (10.5 x 21.5 x 6)	2 (.91)	12	18
5433	Anodized	4¼ x 8½ x 3½ (10.8 x 21.6 x 8)	3 (1.36)	12	24
S5433	Nonstick	4¼ x 8½ x 3½ (10.8 x 21.6 x 8)	3 (1.36)	12	12
5435	Anodized	5 x 10 x 4 (12.7 x 25.4 x 10.2)	5 (2.27)	12	6
S5435	Nonstick	5 x 10 x 4 (12.7 x 25.4 x 10.2)	5 (2.27)	12	6

Wear-Ever Economy Loaf Pans

- 3000 series aluminum



ITEM #	DIMENSIONS: IN (CM)	GAUGE	CASE LOT
5216*	4½ x 16 x 4¾ (11.4 x 40.6 x 10.5)	16	6
51008*	9¼ x 5¼ x 2¾ (23.5 x 13.3 x 7)	18	6
2773L	11¼ x 4½ x 2¾ (28.6 x 11.4 x 7)	18	6

*NSF® certified

Wear-Ever Cake Pan

- 3000 series aluminum



ITEM #	PREVIOUS ITEM #	FINISH	OUTSIDE DIAMETER: IN (CM)	DEPTH: IN (CM)	GAUGE	CASE LOT
5347	—	Natural	9 (22.9)	2 (5.1)	—	24
S5347*	—	Nonstick	9 (22.9)	2 (5.1)	—	12
68099	51003	Natural	9¾ (24.5)	1½ (3.8)	18	6
51016	—	Natural	10 (25.4)	2 (5.1)	20	6

*NSF certified

Wear-Ever Pie Plates

- 3000 series aluminum
- Standard sizes for commercial applications



ITEM #	FINISH	OUTSIDE DIAMETER: IN (CM)	DEPTH: IN (CM)	GAUGE	CASE LOT
N5834	Natural	9 (22.9)	1 (2.5)	20	24
2844L	Anodized	9 (22.9)	1¼ (3.2)	22	6
68089	Natural	9¾ (24.8)	1¼ (3.2)	18	6
51045	Anodized	10 (25.4)	1¼ (3.2)	20	6
68090	Natural	11¼ (28.6)	1¼ (3.2)	18	6
N5844	Economy	9¾ (24.8)	1¼ (3.2)	22	24



KITCHEN ESSENTIALS

With the right tools, a great chef can become an extraordinary chef. Vollrath's kitchen utensils – from spoons and ladles to cutting boards and mixing bowls – give your culinary team the portion control and durable performance they need to create the ideal culinary experience.

PREPARE AND SERVE ALLERGEN-FREE FOODS

Designate those smallwares that are to be used for preparing and serving allergen-free meals. The purple color provides quick identification for employees and customers.



DID YOU KNOW?

- 15 million Americans have food allergies.
- Every 3 minutes, a food allergy reaction results in a trip to the emergency room.
- Even trace amounts of a food allergen can cause a reaction.
- Learn more at VOLLRATH.com/purple.

WE DESIGN & MANUFACTURE CUSTOM PRODUCTS

Didn't find what you were looking for in the Vollrath catalog? From specialized utensils designed for your menu to branded equipment that promotes your brand, Vollrath will work with you to design and manufacture exactly what you need. Our full-service sales, design, manufacturing, and customer service teams will work through every step, providing you with the solutions to make your foodservice business run smoothly and profitably. Your custom product is only a call away.

Learn more at VOLLRATH.com/custom.



LOOK FOR THE JACOB'S PRIDE® LOGO AND
CHOOSE YOUR PRODUCTS WITH CONFIDENCE.

How to Shop

KITCHEN ESSENTIALS

Portion Control

Whether your staff is serving up portions or your customers are filling their own plates, portion control items can help you limit waste and lower your operating costs.



SPOODLE®
Pages 141-142



LADLES
Pages 143-145



DISHERS
Pages 146-148

Serving Utensils

Our extensive selection of serving utensils means you have a durable, easy-to-use option for whatever you're dishing up.



SPOONS
Pages 149-150



TONGS
Pages 151-153



ICE CREAM SCOOPS & SPADES
Page 154

Prep Utensils & Tools

Keep your kitchen running efficiently with durable prepping utensils – from spatulas and skimmers to color-coded cutting boards.



TURNERS
Page 155



SKIMMERS
Page 156



SPATULAS, SOFT SPOONS & WHIPS
Pages 157-158



CUTTING BOARDS
Page 159



MEASURING TOOLS
Pages 160-162



MIXING BOWLS
Page 163



COLANDERS & STRAINERS
Pages 164-165



SQUEEZE DISPENSERS
Pages 166-170



MISCELLANEOUS TOOLS
Pages 171-175



FOOD STORAGE
Page 175

PORTION CONTROL

- Delivering proper nutrition and controlling food costs demand accurate, repeatable results. Learn more at VOLLRATH.com/portion

COLOR		CAPACITY (OUNCES)	CAPACITY (CUPS)	APPROX. SERVINGS PER QUART
	Purple	¾	¾ ₂	40
	Black	1	½	30
	Red	1½	¾	24
	Yellow	1¾	¾ ₂	20
	Blue	2	¾	16
	Green	2¾	¾	12
	Ivory	3	¾ ₈	10
	Grey	4	¾	8
	White	5¾	¾ ₃	6
	Teal	6	¾	5
	Orange	8	1	4

SPOODLE® UTENSILS



One-Piece Heavy-Duty Spoodle Utensil

- One-piece construction is durable and sanitary
- Color-coded for quick size identification
- Capacities clearly stamped on shaft for easy size identification
- High-temperature, patented nylon handle — heat resistant to 450°F (232°C)
- Handles contain an all-natural antimicrobial material



Built-in stopper notch prevents Spoodle from sliding into food product



Unique oval bowl design fits into corners of Super Pan V® Steam Table Pans — reducing waste and maximizing serving efficiency

HOW MUCH COULD YOU SAVE?

+ 19¢ PER ½ OZ OVER-PORTION
x 100 servings per day
x 365 days
= **\$6,935.00 PER YEAR**

SOLID ITEM #	PERFORATED ITEM #	HANDLE COLOR	CAPACITY: OZ (ML)	OVERALL LENGTH: IN (CM)	CASE LOT
ONE-PIECE ROUND SPOODLE UTENSIL					
6433120	6432120	Black	1 (29.6)	12 ³ / ₁₆ (30.9)	12
6433220	6432220	Black	2 (59.1)	12 ¹ / ₁₆ (32.1)	12
6433230	6432230	Blue	2 (59.1)	12 ¹ / ₁₆ (32.1)	12
6433320	6432320	Black	3 (88.7)	13 ³ / ₁₆ (33.1)	12
6433335	6432335	Ivory	3 (88.7)	13 ³ / ₁₆ (33.1)	12
6433480*	6432480*	Purple	4 (118)	13 ⁵ / ₁₆ (33.8)	12
6433420	6432420	Black	4 (118)	13 ⁵ / ₁₆ (33.8)	12
6433445	6432445	Grey	4 (118)	13 ⁵ / ₁₆ (33.8)	12
6433520	6432520	Black	5 (147.9)	13 ¹ / ₂ (33.4)	12
6433580*	—	Purple	5 (147.9)	13 ¹ / ₂ (33.4)	12
6433620	6432620	Black	6 (177.4)	13 ³ / ₄ (35)	12
6433655	6432655	Teal	6 (177.4)	13 ³ / ₄ (35)	12
6433820	6432820	Black	8 (236)	14 ³ / ₁₆ (35.9)	12
6433865	6432865	Orange	8 (236)	14 ³ / ₁₆ (35.9)	12
ONE-PIECE OVAL SPOODLE UTENSIL					
6412120	6422120	Black	1 (29.6)	12 ¹ / ₂ (31.6)	12
6412220	6422220	Black	2 (59.1)	13 ¹ / ₁₆ (33.1)	12
6412230	6422230	Blue	2 (59.1)	13 ¹ / ₁₆ (33.1)	12
6412320	6422320	Black	3 (88.7)	13 ¹ / ₂ (34.2)	12
6412335	6422335	Ivory	3 (88.7)	13 ¹ / ₂ (34.2)	12
6412420	6422420	Black	4 (118)	13 ³ / ₁₆ (35.1)	12
6412445	6422445	Grey	4 (118)	13 ³ / ₁₆ (35.1)	12
6412520	6422520	Black	5 (147.9)	14 ¹ / ₁₆ (35.8)	12
6412620	6422620	Black	6 (177.4)	14 ³ / ₁₆ (36.4)	12
6412655	6422655	Teal	6 (177.4)	14 ³ / ₁₆ (36.4)	12
6412820	6422820	Black	8 (236)	14 ³ / ₄ (37.5)	12
6412865	6422865	Orange	8 (236)	14 ³ / ₄ (37.5)	12

*Purple color for use with allergen-free foods

High-Heat Nylon Spoodle® Utensil

- Ideal for nonstick cookware; will not scratch or mar surfaces
- High-temperature nylon – heat resistant to 475°F (246°C)
- One-piece construction is extremely durable and has no crevices to collect water or bacteria
- Built-in stopper notch prevents utensils from sliding into food product
- Capacities clearly stamped on utensil for easy size identification



BLACK ITEM #	WHITE ITEM #	DESCRIPTION	CAPACITY: OZ (ML)	OVERALL LENGTH: IN (CM)	CASE LOT
ROUND NYLON SPOODLE UTENSIL					
5283520	–	Solid	3 (88.7)	12 $\frac{1}{8}$ (30.7)	12
5283620	–	Perforated	3 (88.7)	12 $\frac{1}{8}$ (30.7)	12
5283720	–	Solid	4 (118.3)	12 $\frac{3}{8}$ (31.4)	12
5283820	–	Perforated	4 (118.3)	12 $\frac{3}{8}$ (31.4)	12
5283920	–	Solid	6 (177.4)	12 $\frac{5}{8}$ (31.9)	12
5284020	–	Perforated	6 (177.4)	12 $\frac{5}{8}$ (31.9)	12
OVAL NYLON SPOODLE UTENSIL					
5292620	–	Solid	3 (88.7)	12 $\frac{1}{8}$ (30.7)	12
5292720	–	Perforated	3 (88.7)	12 $\frac{1}{8}$ (30.7)	12
5292820	5292815	Solid	4 (118.3)	12 $\frac{3}{8}$ (31.4)	12
5292920	5292915	Perforated	4 (118.3)	12 $\frac{3}{8}$ (31.4)	12
5293320	–	Solid	6 (177.4)	12 $\frac{5}{8}$ (31.9)	12
5293420	–	Perforated	6 (177.4)	12 $\frac{5}{8}$ (31.9)	12

Spoodle Utensil with Grip 'N Serv® Handles

- Color-coded handle for no-guess size selection
- Stainless steel shaft and bowl
- Stopper prevents Spoodle from sliding into pan when not in use
- Plastic handles are heat resistant to 230°F (110°C)
- Handles contain an all-natural antimicrobial material



SOLID ITEM #	PERFORATED ITEM #	HANDLE COLOR	CAPACITY: OZ (ML)	OVERALL LENGTH: IN (CM)	CASE LOT
61147	61145	Black	1 (29.6)	12 $\frac{1}{8}$ (31.6)	12
62157	62155	Blue	2 (59.1)	12 $\frac{1}{2}$ (31.8)	12
62167	62165	Ivory	3 (88.7)	13 $\frac{1}{8}$ (33.2)	12
62172	62170	Grey	4 (118.3)	13 $\frac{1}{2}$ (34.3)	12
62177	62175	Teal	6 (177.4)	13 $\frac{3}{8}$ (35.1)	12
62182	62180	Orange	8 (236.6)	14 $\frac{1}{8}$ (35.9)	12
61157	61155	Black	2 (59.1)	12 $\frac{1}{2}$ (31.8)	12
61167	61165	Black	3 (88.7)	13 $\frac{1}{8}$ (33.2)	12
61172	61170	Black	4 (118.3)	13 $\frac{1}{2}$ (34.3)	12
61174	–	Black	5 (148)	13 $\frac{3}{8}$ (35.1)	12
61177	61175	Black	6 (177.4)	13 $\frac{3}{8}$ (35.1)	12
61182	61180	Black	8 (236.6)	14 $\frac{1}{8}$ (35.9)	12

LADLES



One-Piece Heavy-Duty Ladles

- One-piece construction for easy cleaning
- Accurate bowl dimensions ensure consistent capacities
- Capacities clearly stamped on product for easy identification
- Jacob's Pride® warranty does not cover Kool-Touch® coating
- Handles contain an all-natural antimicrobial material
- Kool-Touch handles are color safe up to 225°F (107.2°C)
- Fully functional to 350°F (176.6°C)



Go to VOLLRATH.com/portion for tools to jumpstart your portion control program and improve your bottom line.

4981220

4980810

Color-coded
Kool-Touch handles

ITEM #	HANDLE COLOR	CAPACITY: OZ (ML)	BOWL DIAMETER: IN (CM)	HANDLE LENGTH: IN (CM)	CASE LOT
COLOR-CODED KOOL-TOUCH HANDLES					
4980120	Black	1 (29.6)	1¼ (4.4)	9¾ (25.1)	12
4980230	Blue	2 (59.1)	2¾ (6)	9¾ (25.1)	12
4980280*	Purple	2 (59.1)	2¾ (6)	9¾ (25.1)	12
4980335	Ivory	3 (88.7)	2¾ (7.3)	12¾ (32.1)	12
4980445	Grey	4 (118.3)	3¾ (8.6)	12¾ (32.1)	12
4980480*	Purple	4 (118.3)	3¾ (8.6)	12¾ (32.1)	12
4980655	Teal	6 (177.4)	3½ (8.9)	12¾ (31.4)	12
4980865	Orange	8 (236.6)	4 (10.2)	12¾ (32.1)	12

STAINLESS ITEM #	BLACK ITEM #	CAPACITY: OZ (ML)	BOWL DIAMETER: IN (CM)	HANDLE LENGTH: IN (CM)	CASE LOT
STAINLESS STEEL AND BLACK KOOL-TOUCH HANDLES					
4987510	4987520	¾ (22.2)	1½ (3.4)	9 (22.9)	12
4980110	4980120	1 (29.6)	1¼ (4.4)	9¾ (25.1)	12
4981510	4981520	1½ (44.4)	2¾ (6)	9¾ (25.1)	12
4980210	4980220	2 (59.1)	2¾ (6)	9¾ (25.1)	12
4980310	4980320	3 (88.7)	2¾ (7.3)	12¾ (32.1)	12
4980410	4980420	4 (118.3)	3¾ (8.6)	12¾ (32.1)	12
4980510	4980520	5 (147.9)	3¾ (8.6)	12½ (31.8)	12
4980610	4980620	6 (177.4)	3½ (8.9)	12¾ (31.4)	12
4980810	4980820	8 (236.6)	4 (10.2)	12¾ (32.1)	12
4981210	4981220	12 (354.9)	4¾ (11.1)	12½ (30.8)	6
4982410	4982420	24 (709.8)	6 (15.2)	18¾ (46)	6
4987210	4987220	72 (2129.3)	8¾ (20.6)	17 (43.2)	3

ONE-PIECE HEAVY-DUTY LADLES WITH SHORT HANDLES					
4980010	4980020	½ (14.8)	1¼ (4.4)	6 (15.2)	12
4970110	4970120	1 (29.5)	1 ⁷ / ₃₂ (4.7)	6 (15.2)	12
4971510	4971520	1½ (44.3)	2 ⁹ / ₆₄ (6.2)	6 (15.2)	12
4970210	4970220	2 (59.0)	2 ¹⁵ / ₃₂ (6.3)	6 (15.2)	12
4970310	4970320	3 (88.5)	2 ⁶ / ₆₄ (7.5)	6 (15.2)	12
4970410	4970420	4 (118.0)	3 ²⁷ / ₆₄ (8.7)	6 (15.2)	12
4970510	4970520	5 (147.5)	3 ¹³ / ₃₂ (8.7)	6 (15.2)	12
4970610	4970620	6 (177.0)	3 ¹⁹ / ₃₂ (9.1)	6 (15.2)	12

*Purple color for use with allergen-free foods

Ladles with Kool-Touch® Handles

- Capacities are permanently stamped on the handle
- Kool-Touch handles are color safe up to 225°F (107.2°C)
- Fully functional to 350°F (176.6°C)
- Stainless steel
- Kool-Touch handles contain an all-natural antimicrobial material



ITEM #	HANDLE COLOR	CAPACITY: OZ (ML)	BOWL DIAMETER: IN (CM)	HANDLE LENGTH: IN (CM)	CASE LOT
ROUND LADLES WITH COLOR-CODED KOOL-TOUCH HANDLES					
58011	Black	1 (29.6)	1 ¹ / ₁₆ (4.6)	10 (25.4)	12
58022	Black	2 (59.1)	2 ¹ / ₄ (5.7)	9 ⁷ / ₈ (25.1)	12
58033	Black	3 (88.7)	2 ⁹ / ₁₆ (6.8)	12 ³ / ₈ (32.1)	12
58044	Black	4 (118.3)	2 ⁷ / ₈ (7.3)	12 ³ / ₈ (32.1)	12
58055	Black	6 (177.4)	3 ⁵ / ₈ (9.1)	12 ³ / ₈ (31.4)	12
58066	Black	8 (236.6)	4 (10.2)	12 ³ / ₈ (32.1)	12
58322	Blue	2 (59.1)	2 ¹ / ₄ (5.7)	9 ⁷ / ₈ (25.1)	12
58333	Ivory	3 (88.7)	2 ⁹ / ₁₆ (6.8)	12 ³ / ₈ (32.1)	12
58344	Grey	4 (118.3)	2 ⁷ / ₈ (7.3)	12 ³ / ₈ (32.1)	12
58355	Teal	6 (177.4)	3 ⁵ / ₈ (9.1)	12 ³ / ₈ (31.4)	12
58366	Orange	8 (236.6)	4 (10.2)	12 ³ / ₈ (32.1)	12
OVAL LADLE WITH BLACK KOOL-TOUCH HANDLE					
56728	Black	8 (236)	4 ¹ / ₁₆ x 3 ¹ / ₄ x 1 ¹ / ₁₆ (11.9 x 8.3 x 4.6)	12 ¹ / ₂ (31.8)	12
ROUND LADLES WITH STAINLESS STEEL HANDLES					
58000	—	½ (14.8)	1 ⁵ / ₈ (4.2)	6 (15.2)	12
58410	—	1 (29.6)	1 ¹ / ₁₆ (4.6)	6 ⁷ / ₈ (17.5)	12
58510	—	1 (29.6)	1 ¹ / ₁₆ (4.6)	10 (25.4)	12
58520	—	1½ (44.4)	2 ³ / ₃₂ (5.3)	9 ⁷ / ₈ (25.1)	12
58620	—	2 (59.1)	2 ¹ / ₄ (5.7)	9 ⁷ / ₈ (25.1)	12
58430	—	3 (88.7)	2 ⁹ / ₁₆ (6.8)	12 ³ / ₈ (32.1)	12
58440	—	4 (118.3)	2 ⁷ / ₈ (7.3)	12 ³ / ₈ (32.1)	12
58450	—	5 (147.9)	3 ³ / ₁₆ (8.1)	12 ¹ / ₂ (31.8)	12
58460	—	6 (177.4)	3 ⁵ / ₈ (9.1)	12 ³ / ₈ (31.4)	12
58480	—	8 (236.6)	4 (10.2)	12 ³ / ₈ (32.1)	12
58500	—	12 (354.9)	4 ³ / ₈ (11.1)	12 ¹ / ₂ (30.8)	6
58540	—	24 (709.8)	6 (15.2)	18 ¹ / ₈ (46)	6
58600	—	72 (2129.3)	8 ¹ / ₂ (20.6)	17 (43.2)	3

One-Piece Ergo Grip™ Ladles with Kool-Touch Handles

- Offset handle for more comfortable use
- One-piece stainless steel construction with black handle
- Handle stopper keeps the ladle from sliding into serving container
- Shorter overall length permits easy serving under low-profile breath guards
- Kool-Touch handles are color safe up to 225°F (107.2°C)
- Fully functional to 350°F (176.6°C)



ITEM #	CAPACITY: OZ (ML)	BOWL DIAMETER: IN (CM)	OVERALL LENGTH: IN (CM)	LENGTH: IN (CM)*	CASE LOT
4980322	3 (88.7)	2 ⁷ / ₈ (7.3)	13 ³ / ₈ (33.3)	10 ⁷ / ₈ (27.6)	6
4980422	4 (118.3)	3 ¹ / ₈ (7.9)	13 ³ / ₈ (33.3)	10 ⁷ / ₈ (27.6)	6
4980622	6 (177.4)	3 ³ / ₈ (8.6)	13 ¹ / ₄ (33.6)	10 ⁷ / ₈ (27.6)	6
4980822	8 (236.6)	4 ¹ / ₁₆ (10.3)	14 ¹ / ₄ (36.2)	11 ¹ / ₂ (29.2)	6

*Length from bowl bottom to bend in handle

Economy One-Piece Ladles

- One-piece stainless steel construction
- Capacity permanently marked on handle



ITEM #	CAPACITY OZ (ML)	BOWL DIAMETER IN (CM)	HANDLE LENGTH IN (CM)	CASE LOT
46810	½ (14.8)	1 ⁵ / ₁₆ (4.9)	11 (27.9)	24
46819	¾ (22)	1 ⁵ / ₁₆ (4.9)	11 (27.9)	24
46811	1 (29.6)	1 ⁵ / ₁₆ (4.9)	11 (27.9)	24
46812	2 (59.1)	2 ⁷ / ₃₂ (6.4)	11 (27.9)	24
46813	3 (88.7)	2 ⁹ / ₁₆ (7.1)	11 (27.9)	24
46814	4 (118.3)	3 ³ / ₈ (7.9)	12½ (31.8)	12
46816	6 (177.4)	3 ³ / ₈ (8.6)	12½ (31.8)	12
46818	8 (236.6)	4 ¹ / ₈ (10.3)	12½ (31.8)	12
46822	12 (354.9)	4 ¹ / ₈ (11.9)	13 (33)	12

Economy Two-Piece Ladles

- Stainless steel
- Capacity marked for portion control



ITEM #	CAPACITY OZ (ML)	BOWL DIAMETER IN (CM)	HANDLE LENGTH IN (CM)	CASE LOT
46900	½ (14.8)	1 ¹ / ₄ (4.4)	10 ⁷ / ₈ (27.6)	24
46901	1 (29.6)	1 ¹ / ₄ (4.8)	10 ⁷ / ₈ (27.6)	24
46915	1½ (44.4)	2 ⁷ / ₁₆ (6.1)	8 ³ / ₈ (21.3)	12
46902	2 (59.1)	2 ⁹ / ₁₆ (6.5)	11¼ (28.6)	24
46903	3 (88.7)	3 (7.6)	11½ (29.2)	24
46904	4 (118.3)	3¼ (8.2)	12½ (31.8)	12
46906	6 (177.4)	3½ (8.9)	12½ (31.8)	12
46908	8 (236.6)	4 (10.2)	12¾ (32.4)	12
46912	12 (354.9)	4 ³ / ₁₆ (11.6)	15½ (39.4)	12
46924	24 (709.8)	6 (15.3)	14 (35.6)	10
46932	32 (946.4)	6 ⁵ / ₈ (16.8)	15¾ (40)	10

Bicolite Ladle

- Clear plastic is heat resistant to 180°F (82°C)



ITEM #	CAPACITY OZ (ML)	BOWL DIAMETER IN (CM)	OVERALL LENGTH IN (CM)	CASE LOT
52908	½ (14.8)	1 ¹ / ₄ (4.1)	6½ (16.5)	72

One-Quart Hooked-Handle Dipper

- Graduations marked clearly inside and outside
- Welded, hooked handle prevents dipper from sliding into container



ITEM #	CAPACITY QT (L)	OVERALL LENGTH IN (CM)	HANDLE LENGTH IN (CM)	BOWL HEIGHT IN (CM)	CASE LOT
58700	1 (0.9)	15 (38.1)	12 (30.5)	3½ (8.9)	6

Professional Transfer Ladles and Dippers

- Dent-resistant 3004 aluminum alloy
- Seamless construction
- Welded handles



ITEM #	CAPACITY: OZ (ML)	OVERALL LENGTH: IN (CM)	CASE LOT
5330	30 (0.9)	11½ (29.2)	3
4752	64 (1.9)	12¾ (32.4)	3
5332	64 (1.9)	13 ⁵ / ₈ (34.3)	3

DISHERS

THE PERFECT PORTION EVERY TIME



One-Piece Thumb Dishers

- Accurate portions
- Dishwasher safe
- Not recommended for use with ice cream, frozen foods, or other hard food products
- Handles contain an all-natural antimicrobial material
- The disher size denotes the number of servings per quart



ITEM #	HANDLE COLOR	SIZE	CAPACITY: OZ (ML)	BOWL DIAMETER: IN (CM)	OVERALL LENGTH: IN (CM)	CASE LOT
47139	White	6	5½ (157.7)	3⅞ (7.9)	9⅞ (25)	12
47140	Grey	8	4 (118.3)	2⅞ (7.1)	9⅞ (24.3)	12
47141	Ivory	10	3¼ (96.1)	2⅞ (6.7)	9⅞ (23.8)	12
47142	Green	12	2⅞ (78.9)	2⅞ (6.2)	9⅞ (23.3)	12
47143	Blue	16	2 (59.1)	2⅞ (5.6)	8⅞ (22.8)	12
47144	Yellow	20	1⅞ (48.1)	2 (5.2)	8¾ (22.3)	12
47145	Red	24	1⅓ (39.4)	1⅞ (4.8)	8⅞ (22)	12
47146	Black	30	1 (29.6)	1¾ (4.4)	8½ (21.6)	12
47147	Orchid	40	¾ (22.2)	1⅞ (4)	8⅞ (21.1)	12

visit VOLLRATH.com/portion

Delivering proper nutrition and controlling your food costs demand accurate, repeatable portion sizing. But, how do you ensure that your kitchen staff and servers are using the proper-size utensil? Vollrath simplifies portion control with a complete system of serving utensils, color coded for quick and easy size selection. If your menu calls for 2 ounces of vegetables, tell your staff to use the blue Spoodle®. Serving 4 ounces of stuffing? Use a grey disher. It's that simple. No more searching through a drawer of look-alike utensils trying to read the capacity stamps.

COLOR	CAPACITY (OUNCES)	CAPACITY (CUPS)	APPROX. SERVINGS PER QUART	DISHER	ROUND SPOODLE One-piece solid/perf. Two-piece solid/perf.	OVAL SPOODLE One-piece solid/perf.	LADLE One-piece Two-piece
Orchid	¾	¾	40	47147			
Black	1	⅞	30	47146	6433120 / 6432120 62147 / 62145	6412120 / 6422120	4980120 58011
Red	1⅓	⅞	24	47145			4980230 58322
Yellow	1⅞	⅞	20	47144			
Blue	2	¾	16	47143	6433230 / 6432230 62157 / 62155	6412230 / 6422230	4980335 58333
Green	2⅞	⅞	12	47142			
Ivory	3	¾	10	47141	6433335 / 6432335 62167 / 62165	6412335 / 6422335	4980445 58344
Grey	4	⅞	8	47140	6433445 / 6432445 62172 / 62170	6412445 / 6422445	
White	5½	⅞	6	47139			
Teal	6	¾	5		6433655 / 6432655 62177 / 62175	6412655 / 6422655	4980655 58355
Orange	8	1	4		6433865 / 6432865 62182 / 62180	6412865 / 6422865	4980865 58366

Squeeze Dishers

- Standard-length and extended-length handles that work with all steam table pan depths
- Two-part construction helps prevent loss of parts
- Perfect portion control in 17 sizes
- Universal handle design is equally comfortable for right- or left-handed users
- Not recommended for use with ice cream, frozen foods, or other hard food products



STANDARD LENGTH ITEM #	EXTENDED LENGTH ITEM #	HANDLE COLOR	SIZE	CAPACITY OZ (ML)	BOWL DIAMETER IN (CM)	STANDARD OVERALL LENGTH DIMENSIONS: IN (CM)	EXTENDED OVERALL LENGTH DIMENSIONS: IN (CM)	CASE LOT
47388	—	Orange	4	8 (236.6)	3 $\frac{3}{8}$ (9.2)	10 $\frac{1}{2}$ (25.6)	—	12
47389	—	Teal	5	6 (177.4)	3 $\frac{3}{8}$ (8.6)	9 $\frac{3}{4}$ (24.8)	—	12
47390	47370	White	6	4.7 (139)	3 (7.6)	9 $\frac{3}{4}$ (24.4)	10 $\frac{1}{2}$ (27.6)	12
47391	47371	Grey	8	3.7 (109.5)	2 $\frac{1}{2}$ (7.3)	9 $\frac{1}{4}$ (23.8)	10 $\frac{5}{8}$ (27)	12
47392	47372	Ivory	10	3.2 (96)	2 $\frac{3}{4}$ (7)	9 $\frac{1}{4}$ (23.8)	10 $\frac{1}{2}$ (26.7)	12
47393	47373	Green	12	2.8 (83.6)	2 $\frac{1}{2}$ (6.4)	9 $\frac{1}{8}$ (23.2)	10 $\frac{3}{8}$ (26.4)	12
47394	—	Sky Blue	14	2.4 (71.4)	2 $\frac{3}{8}$ (6)	9 (22.9)	—	12
47395	47374	Royal Blue	16	2 (59.5)	2 $\frac{1}{4}$ (5.7)	8 $\frac{7}{8}$ (22.5)	10 (25.5)	12
47396	47375	Yellow	20	1.8 (53.4)	2 $\frac{1}{4}$ (5.7)	8 $\frac{3}{4}$ (22.2)	10 (25.5)	12
47397	47376	Red	24	1.52 (45)	2 (5.1)	8 $\frac{1}{2}$ (21.6)	9 $\frac{1}{8}$ (25.1)	12
47398	47377	Black	30	1.13 (33.3)	1 $\frac{1}{2}$ (4.8)	8 $\frac{1}{4}$ (20.8)	9 $\frac{1}{2}$ (24.4)	12
47399	—	Mushroom	36	.94 (27.8)	1 $\frac{1}{4}$ (4.4)	8 $\frac{1}{4}$ (20.8)	—	12
47400	47378	Orchid	40	.72 (21.2)	1 $\frac{5}{8}$ (4.1)	7 $\frac{7}{8}$ (20.1)	9 $\frac{1}{4}$ (23.5)	12
47401	—	Terracotta	50	.65 (19.2)	1 $\frac{1}{2}$ (3.8)	7 $\frac{7}{8}$ (20.1)	—	12
47402	47379	Pink	60	.54 (15.9)	1 $\frac{1}{8}$ (3.5)	7 $\frac{3}{4}$ (19.7)	9 $\frac{1}{8}$ (23.2)	12
47403	—	Plum	70	.47 (13.8)	1 $\frac{1}{4}$ (3.2)	7 $\frac{3}{4}$ (19.7)	—	12
47404	—	Orange	100	.33 (9.6)	1 $\frac{1}{8}$ (2.9)	7 $\frac{1}{2}$ (19.1)	—	12



Stainless Steel Dishers

- Stainless steel construction
- For use with either left or right hand
- Not recommended for use with ice cream, frozen foods, or other hard food products



ITEM #	SIZE	CAPACITY: OZ (ML)	BOWL SIZE (LENGTH X WIDTH): IN (CM)	OVERALL LENGTH: IN (CM)	CASE LOT
ROUND SQUEEZE DISHERS					
T7206	6	5½ (157.6)	3⅞ (7.9) dia	9⅞ (23.2)	12
47150	8	4 (118.3)	2¾ (6.7) dia	9⅞ (23.2)	12
47151	10	3⅞ (92.4)	2⅝ (6.5) dia	8⅞ (22.5)	12
47152	12	2¾ (81.3)	2⅞ (6.2) dia	8⅞ (22.5)	12
47153	16	2 (59.1)	2⅝ (5.6) dia	8½ (21.6)	12
47154	20	1½ (44.4)	2⅞ (5.2) dia	8½ (21.6)	12
47155	24	1⅞ (40.7)	1⅝ (4.9) dia	8¼ (21)	12
47156	30	1¼ (37)	1⅞ (4.8) dia	8¼ (21)	12
47157	40	⅞ (25.9)	1⅝ (4.1) dia	8 (20.3)	12
47158	50	⅝ (18.5)	1½ (3.8) dia	7⅞ (20)	12
47159	60	⅜ (16.6)	1⅝ (3.3) dia	7¾ (19.7)	12
47160	70	½ (14.3)	1⅞ (3.5) dia	7¾ (19.7)	12
47161	100	⅜ (11.1)	1⅞ (2.9) dia	7½ (19.1)	12
OVAL SQUEEZE DISHERS					
47169	14	2⅝ (68)	2¾ x 2⅝ ₂ (7 x 5.5)	10¼ (26)	10
47170	20	1⅞ (46)	2½ x 1⅞ (6.3 x 4.8)	10 (25.4)	10
47171	24	1⅝ (38)	2⅝ ₂ x 1⅞ (5.8 x 4.6)	9¾ (24.8)	10
47172	30	1⅝ (28)	2⅝ ₂ x 1⅞ (5.3 x 4.1)	9⅞ (24.5)	10
47200	40	¾ (22.2)	2 x 1⅞ (5 x 3.6)	9½ (24.1)	10

SPOONS

UNRIVALED STRENGTH,
COMFORT & DESIGN



Stainless Steel Basting Spoons with Ergo Grip™ Handles

- One-piece stainless steel construction is extremely durable and has no crevices to collect water or bacteria
- High-temperature, patented nylon handle – heat resistant to 450°F (232°C)
- Built-in stopper notch prevents spoon from sliding into food product
- Three-sided spoon has one straight edge for cutting to aid in serving solid, sticky, or cheesy food products
- Handles contain an all-natural antimicrobial material



Go to VOLLRATH.com/jp for more information on Jacob's Pride® and tools to jumpstart your portion control program.

DESCRIPTION	BLACK ITEM #	WHITE ITEM #	BLUE ITEM #	RED ITEM #	YELLOW ITEM #	GREEN ITEM #	PURPLE ITEM #	OVERALL LENGTH IN (CM)	CASE LOT
Solid	64130	6414015	6414030	6414040	6414050	6414070	6414080*	13 ³ / ₁₆ (35.1)	12
Perforated	64132	6414215	6414230	6414240	6414250	6414270	6414280*	13 ³ / ₁₆ (35.1)	12
Slotted	64134	—	—	—	—	—	—	13 ³ / ₁₆ (35.1)	12
3-sided solid	64136	—	—	—	—	—	—	13 ³ / ₁₆ (33.8)	12
3-sided perforated	64138	—	—	—	—	—	—	13 ³ / ₁₆ (33.8)	12

*Purple color for use with allergen-free foods

Stainless Steel Basting Spoons

- One-piece stainless steel construction
- Patented handle with unique turned-down design for unrivaled strength and comfort



SOLID ITEM #	PERFORATED ITEM #	SLOTTED ITEM #	LENGTH IN (CM)	CASE LOT
64400	64401	64402	11 ¹ / ₄ (29.8)	12
64403	64404	64405	13 ¹ / ₄ (33.7)	12
64406	64407	64408	15 ¹ / ₂ (39.4)	12



Go to VOLLRATH.com for more information on product specifications, tools to jumpstart your portion control program, and videos on antimicrobial, NSF®, and HACCP products,

Standard Stainless Steel Basting Spoons

- 18-gauge stainless steel
- Grip 'N Serv® handles option
- Handles heat resistant to 230°F (110°C)
- Thumb notch for comfortable use and to prevent spoon from sliding into pan
- Three-sided spoons offer flat cutting edge



SOLID ITEM #	PERFORATED ITEM #	SLOTTED ITEM #	OVERALL LENGTH IN (CM)	CASE LOT
WITH STAINLESS HANDLES				
46961	46962	46963	11 (27.9)	12
46973	46975	46976	13 (33)	12
46981	46983	46985	15 (38.1)	12
46990	—	—	18 (45.7)	12
46995	—	—	21 (53.3)	12
WITH GRIP 'N SERVE HANDLES*				
46945*	Solid		14 (35.6)	12
46946*	Perforated		14 (35.6)	12
46947*	Slotted		14 (35.6)	12
46948*	3-sided solid		13 ³ / ₁₆ (34.9)	12
46949*	3-sided perforated		13 ³ / ₁₆ (34.9)	12

* Not NSF® certified

High-Heat Nylon Spoons

- High-temperature nylon – heat resistant to 475°F (246°C)
- Ideal for nonstick cookware – will not scratch or mar surface
- One-piece construction is extremely durable and has no crevices to collect water or bacteria



BLACK ITEM #	DESCRIPTION	OVERALL LENGTH: IN (CM)	CASE LOT
5284220	Solid	13¼ (33.7)	12
5284320	Slotted	13¼ (33.7)	12

Nylon Prep Spoons

- Available in five colors for use in HACCP programs
- High-temperature nylon – heat resistant to 400°F (204°C)
- Ideal for nonstick cookware – will not scratch or mar surfaces
- One-piece construction is extremely durable and has no crevices to collect water or bacteria



8½" spoon is perfect for small or 9th-size pans

ITEM #	COLOR	OVERALL LENGTH: IN (CM)	CASE LOT
4689760	Tan	8½ (21.6)	12
4689815	White	12 (30.5)	12
4689830	Blue	12 (30.5)	12
4689840	Red	12 (30.5)	12
4689850	Yellow	12 (30.5)	12
4689860	Tan	12 (30.5)	12
4689960	Tan	15 (38.1)	12

Hooked-Handle Utensils

- Long handle for large vessels
- One-piece stainless steel construction



FORK ITEM #	SOLID SPOON ITEM #	SLOTTED SPOON ITEM #	HANDLE LENGTH: IN (CM)	CASE LOT
60180	—	—	15 (38.1)	12
60190	60170	60175*	21 (53.3)	12

* 60175 not NSF® certified

TONGS



One-Piece Tongs

- One-piece stainless steel construction
- Unique springless design eliminates bacteria-prone food traps
- Ideal for maximizing your HACCP program
- Utility Grip features concave ends and gently scalloped teeth – ideal for almost any area of the kitchen
- VersaGrip™ features flattened ends and gripper teeth – perfect for grills and broilers
- Heavy-duty stainless steel tongs feature a unique springless design that eliminates bacteria-prone food traps
- Kool-Touch® handles contain an all-natural antimicrobial material
- Kool-Touch Handles are color safe up to 225°F (107.2°C)
- Fully functional to 350°F (176.6°C)

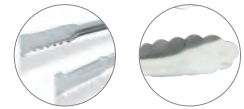

VersaGrip

Utility Grip



What does antimicrobial mean? Visit VOLLRATH.com/nogermis to learn more.



UTILITY ITEM #	VERSAGRIP ITEM #	HANDLE COLOR	OVERALL LENGTH: IN (CM)	CASE LOT
ONE-PIECE COLOR-CODED KOOL-TOUCH HANDLED TONGS				
4780610	—	White	6 (15.2)	12
4780620	—	Black	6 (15.2)	12
4780630	—	Blue	6 (15.2)	12
4780640	—	Red	6 (15.2)	12
4780650	—	Yellow	6 (15.2)	12
4780660	—	Ivory	6 (15.2)	12
4780670	—	Green	6 (15.2)	12
4780680*	—	Purple	6 (15.2)	12
4780920	4790920	Black	9½ (24.1)	12
4781220	4791220	Black	12 (30.5)	12
4781620	4791620	Black	16 (40.6)	12
4780930	4790930	Blue	9½ (24.1)	12
4781230	4791230	Blue	12 (30.5)	12
4781630	4791630	Blue	16 (40.6)	12
4780940	4790940	Red	9½ (24.1)	12
4781240	4791240	Red	12 (30.5)	12
4781640	4791640	Red	16 (40.6)	12
4780950	4790950	Yellow	9½ (24.1)	12
4781250	4791250	Yellow	12 (30.5)	12
4781650	4791650	Yellow	16 (40.6)	12
4780960	4790960	Ivory	9½ (24.1)	12
4781260	4791260	Ivory	12 (30.5)	12
4781660	4791660	Ivory	16 (40.6)	12
4780970	4790970	Green	9½ (24.1)	12
4781270	4791270	Green	12 (30.5)	12
4781670	4791670	Green	16 (40.6)	12
4780980*	—	Purple	9½ (24.1)	12
4781280*	—	Purple	12 (30.5)	12
4781680*	—	Purple	16 (40.6)	12
ONE-PIECE HEAVY-DUTY STAINLESS STEEL TONGS				
4780610	—	Stainless Steel	6 (15.2)	12
4780910	4790910	Stainless Steel	9½ (24.1)	12
4781210	4791210	Stainless Steel	12 (30.5)	12
4781610	4791610	Stainless Steel	16 (40.6)	12

*Purple color for use with allergen-free foods

High-Temperature Nylon-End One-Piece Tongs

- High-temperature nylon is heat resistant up to 450°F (232°C)
- Nylon end will not scratch or mar nonstick surfaces
- Heavy-gauge stainless steel body
- Dishwasher safe
- Kool-Touch® handles are color safe up to 225°F (107.2°C)
- Fully functional to 350°F (176.6°C)



ITEM #	COLOR	OVERALL LENGTH: IN (CM)	CASE LOT
4780912	–	9½ (24.1)	12
4781212	–	12 (30.5)	12
4781612	–	16 (40.6)	12
WITH COATED HANDLES			
4780922	■ Black	9½ (24.1)	12
4781222	■ Black	12 (30.5)	12
4781622	■ Black	16 (40.6)	12
478091280*	■ Purple	9½ (24.1)	12

*Purple color for use with allergen-free foods

Multi-Pack Color-Coded NSF® Utility Tong

- Includes 6 color-coded tongs – one each of black, blue, red, yellow, tan, and green



ITEM #	OVERALL LENGTH: IN (CM)	CASE LOT
4780911	9½ (24.1)	3

Pom Tongs

- One-piece stainless steel construction
- Kool-Touch handles contain an all-natural antimicrobial material
- Kool-Touch handles are color safe up to 225°F (107.2°C)
- Fully functional to 350°F (176.6°C)
- Heavy-duty tongs are 20 gauge
- Dishwasher safe



ITEM #	OVERALL LENGTH: IN (CM)	CASE LOT
KOOL-TOUCH POM TONGS		
47326	6 (15.2)	12
47329	9 (22.9)	12
47322	12 (30.5)	12
HEAVY-DUTY POM TONGS		
47046	6 (15.2)	36
47049	9 (22.9)	24
47042	12 (30.5)	12
ECONOMY POM TONGS		
47106	6 (15.2)	60
47109	9 (22.9)	48
47112	12 (30.5)	12

Utility Tongs

- Heavy-duty tongs are 20-gauge stainless steel and ideal for heavy-use operations
- Economy tongs are 24-gauge stainless steel



HEAVY-DUTY ITEM #	ECONOMY ITEM #	OVERALL LENGTH: IN (CM)	CASE LOT
—	47007	7 (17.8)	12
47309	47110	9½ (24.1)	12
47312	47113	12 (30.5)	12
47316	47116	16 (40.6)	12

Tender-Touch Pastry Tongs

- Unique ribbed gripping surface holds firmly and will not tear food
- Ideal for chicken, fish, and pastry
- Mirror-finished, 16-gauge stainless steel



ITEM #	OVERALL LENGTH: IN (CM)	GRIPPING SURFACE: IN (CM)	CASE LOT
47107	9¼ (23.5)	1½ x 2¾ (3.8 x 7)	12

Heavy-Duty Scissor Tongs

- Chrome-plated wire design
- Extra-long length reaches deep into containers
- Kool-Touch® handles contains an all-natural antimicrobial material



ITEM #	DESCRIPTION	OVERALL LENGTH: IN (CM)	CASE LOT
47325	Kool-Touch handle	15 (38.1)	12

Spaghetti Tongs

- Springless, one-piece design eliminates food traps and is dishwasher safe
- Mirror-finished, heavy-duty stainless steel, which provides elegance, durability, and easy cleaning



ITEM #	OVERALL LENGTH: IN (CM)	CASE LOT
47105	8 (20)	12
46988	9 (22.9)	12
46989	11½ (29.2)	12

ICE CREAM SCOOPS & SPADES



Ice Cream Scoops

- Antifreeze securely encapsulated in handle for easy release from scoop bowl
- Patented ergonomic, textured handle design for a sure grip
- Hanging hole for easy storage
- Durable cast aluminum
- Industry-standard bowl dimensions for consistent portioning
- Colored end cap to easily identify size/capacity
- Hand-wash only, see pg. 78



ITEM #	END CAP COLOR	SIZE	CAPACITY: OZ (ML)	OVERALL LENGTH: IN (CM)	OVERALL HEIGHT: IN (CM)	BOWL WIDTH: IN (CM)	CASE LOT
47274	Brown	10	4 (118.3)	7 ⁵ / ₈ (19.4)	1 ⁷ / ₈ (4.8)	2 ¹ / ₈ (5.4)	12
47275	Blue	12	3 (88.7)	7 ⁵ / ₈ (19.4)	1 ⁷ / ₈ (4.8)	2 ¹ / ₁₆ (5.2)	12
47276	Green	16	2 ¹ / ₂ (73.9)	7 ³ / ₄ (19.7)	1 ⁷ / ₈ (4.8)	1 ⁷ / ₈ (4.8)	12
47277	Gold	20	2 (59.1)	7 ¹ / ₁₆ (18.9)	1 ¹ / ₁₆ (4.3)	1 ³ / ₄ (4.4)	12
47278	Grey	24	1 ¹ / ₂ (44.4)	7 ⁵ / ₈ (19.4)	1 ¹ / ₁₆ (3.7)	1 ⁵ / ₈ (4.1)	12
47279	Red	30	1 (29.6)	7 ¹ / ₂ (19.1)	1 ⁵ / ₁₆ (3.3)	1 ¹ / ₁₆ (3.7)	12

Ice Cream Spade

- Use for scraping sides and leveling the ice cream in tubs
- Great for hand-packing containers and mixing
- Extended handle to reach deep into containers
- Reduces waste by preventing the formation of crystals
- Right-hand or left-hand use
- Antifreeze encapsulated in handle for easy food product release
- Aluminum spade with blue polypropylene end cap



ITEM #	OVERALL LENGTH: IN (CM)	CASE LOT
47270	10 ¹ / ₁₆ (25.8)	12

Economy Ice Cream/Utility Spade

- Stainless steel
- Black plastic handle



ITEM #	OVERALL LENGTH: IN (CM)	CASE LOT
47165	9 (22.9)	12

TURNERS



Heavy-Duty Stainless Steel Turners with Ergo Grip™ Handles

- Ergonomic handle is comfortable and reduces hand fatigue
- High-temperature, patented nylon handle – heat resistant to 450°F (232°C)
- Heavy-gauge stainless steel blade and shaft – resistant to corrosion



Visit VOLLRATH.com/jp to learn more about Jacob's Pride® lifetime warranty.



**ERGONOMIC HANDLE
AUTOMATICALLY RIGHTS
ITSELF TO PROTECT
HANDS, UTENSILS,
AND COOKTOP!**

WHITE ITEM #	BLACK ITEM #	PURPLE ITEM #	BLADE	BLADE DIMENSIONS (L X W): IN (CM)	OVERALL LENGTH: IN (CM)	CASE LOT
4808715	4808720	4808780*	Solid, beveled	6 x 3 (15.2 x 7.6)	13½ (34.3)	12
4808815	4808820	4808880*	Solid	8¼ x 2½ (21 x 7.3)	16½ (41.9)	12
4808915	4808920	—	Perforated	8¼ x 2½ (21 x 7.3)	16½ (41.9)	12

*Purple color for use with allergen-free foods

High-Heat Nylon Slotted Turner

- Ideal for nonstick cookware – will not scratch or mar surface
- High-temperature nylon – heat resistant to 475°F (246°C)
- One-piece construction with built-in stopper notch



ITEM #	BLADE DIMENSIONS (L X W): IN (CM)	OVERALL LENGTH: IN (CM)	CASE LOT
5284120	4¼ x 3¼ (10.8 x 7.3)	13½ (34.3)	12

Small Blade Turner with Grip 'N Serv® Handle

- Flexible blade is made of 24-gauge stainless steel
- Ideal for tortes, lasagna, or other delicate food items
- Grip 'N Serv black handle is heat resistant to 230°F (110°C) and is equipped with antimicrobial protection
- Handle contains an all-natural antimicrobial material



ITEM #	DESCRIPTION	DIMENSIONS (L X W): IN (CM)	OVERALL LENGTH: IN (CM)	CASE LOT
48085	Small blade turner	3¾ x 1½ (9.5 x 4.8)	10½ (26.7)	12

Hamburger Turners

- Stainless steel
- Satin-finished blade with riveted wood handle



ITEM #	BLADE	BLADE DIMENSIONS (L X W): IN (CM)	OVERALL LENGTH: IN (CM)	CASE LOT
48080	Solid, beveled	4¾ x 3 (12.1 x 7.6)	11 (27.9)	12
48081	Solid	7¾ x 3 (19.7 x 7.6)	14 (35.6)	12
48082	Perforated	7¾ x 3 (19.7 x 7.6)	14 (35.6)	12

Pancake Turners

- Stainless steel flexible blade
- Welded construction



ITEM #	BLADE	BLADE DIMENSIONS (L X W): IN (CM)	OVERALL LENGTH: IN (CM)	CASE LOT
46933	Solid	3½ x 6 (7.7 x 15.2)	13¾ (34.9)	12
46934	Slotted	3½ x 6 (7.7 x 15.2)	13¾ (34.9)	12

SKIMMERS

Heavy-Duty One-Piece Skimmers

- One-piece stainless steel construction
- Mirror-finished blade, satin-finished handle



ITEM #	HANDLE LENGTH: IN (CM)	BLADE DIAMETER: IN (CM)	CASE LOT
46969	11¾ (29.8)	4 (10.2)	6
46970	12¾ (32.1)	6 (15.3)	6

Heavy-Duty Long-Handle Wire Mesh Skimmers

- Heavy-duty stainless steel, one-piece design
- Extra-thick-gauge satin-finished handle with center reinforcing rib provides strength and durability



ITEM #	HANDLE LENGTH: IN (CM)	BLADE DIAMETER: IN (CM)	CASE LOT
47717	14 (35.6)	6½ (16.5)	12
47718	14 (35.6)	8 (20.3)	6
47719	17¾ (44.9)	9¾ (24.5)	6

Two-Piece Skimmers

- Stainless steel
- Welded construction



ITEM #	HANDLE LENGTH: IN (CM)	BLADE DIAMETER: IN (CM)	CASE LOT
46972	11¾ (29.8)	4½ (11.4)	6
47175	12¾ (32.4)	6¾ (16)	6

SPATULAS, SOFTSPOONS™ & WHIPS



High-Temperature Spatula and SoftSpoon™ Utensils

- High-temp spatulas feature contoured, flexible blade for use with any-shape container
- High-temp SoftSpoon™ has spoon-shaped blade for convenient scooping of food products
- Ideal for use with nonstick cookware
- Nylon handle and silicone blade are heat resistant to 500°F (260°C)
- Molded silicone rubber nubs keep blade off counter
- Dishwasher safe



ITEM #	DESCRIPTION	DIMENSIONS: IN (CM)	CASE LOT
52010	High-temp spatula	10 (25.4)	6
52023	High-temp spatula	13½ (34.3)	6
52026	High-temp spatula	16½ (41.9)	6
58110	High-temp SoftSpoon™	10 (25.4)	6
58123	High-temp SoftSpoon™	13½ (34.3)	6
58126	High-temp SoftSpoon™	16½ (41.9)	6

Plastic Spatula and SoftSpoon™ Utensils

- Spatulas feature contoured, flexible blade for use with any container
- SoftSpoon™ has spoon-shaped blade for convenient scooping of food products
- Flexible blade retains its shape up to 212°F (100°C)
- Dishwasher safe



ITEM #	DESCRIPTION	DIMENSIONS: IN (CM)	CASE LOT
52009	Plastic spatula	9½ (24.1)	6
52013	Plastic spatula	13¾ (34.6)	6
52016	Plastic spatula	16¾ (42.2)	6
52109	Plastic SoftSpoon™	9½ (24.1)	6
52113	Plastic SoftSpoon™	13¾ (34.6)	6
52116	Plastic SoftSpoon™	16¾ (42.2)	6

Stainless Steel Spatula

- 18-gauge stainless steel beveled blade easily slides under food product
- Tapered handle for sure grip



ITEM #	DESCRIPTION	BLADE DIMENSIONS (L X W): IN (CM)	OVERALL LENGTH: IN (CM)	CASE LOT
46931	Scraper w/black plastic handle	4¾ x 3 (11.3 x 7.9)	9¾ x 3½ (24.6 x 7.9)	12

Pan Scraper

- Ideal for safe cleaning of pans
- Clear, rigid polyethylene

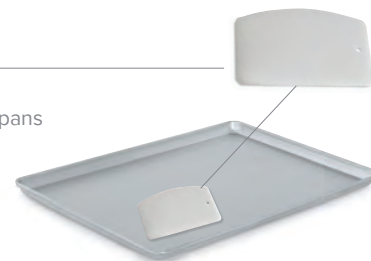

ITEM #	DESCRIPTION	DIMENSIONS: IN (CM)	CASE LOT
1345	Pan scraper	3¾ x 5 (9.2 x 14.3)	72

NSF®-Certified Whips

- Center reinforcement wire eliminates bending, twisting, and deforming
- Wires are constructed from stainless steel to resist corrosion and rusting
- One-piece ergonomic handle with comfort nubs for sure grip
- Nylon handle is heat resistant to 475° F (246°C)



Visit VOLLRATH.com/jp to learn more about Jacob's Pride® lifetime warranty.

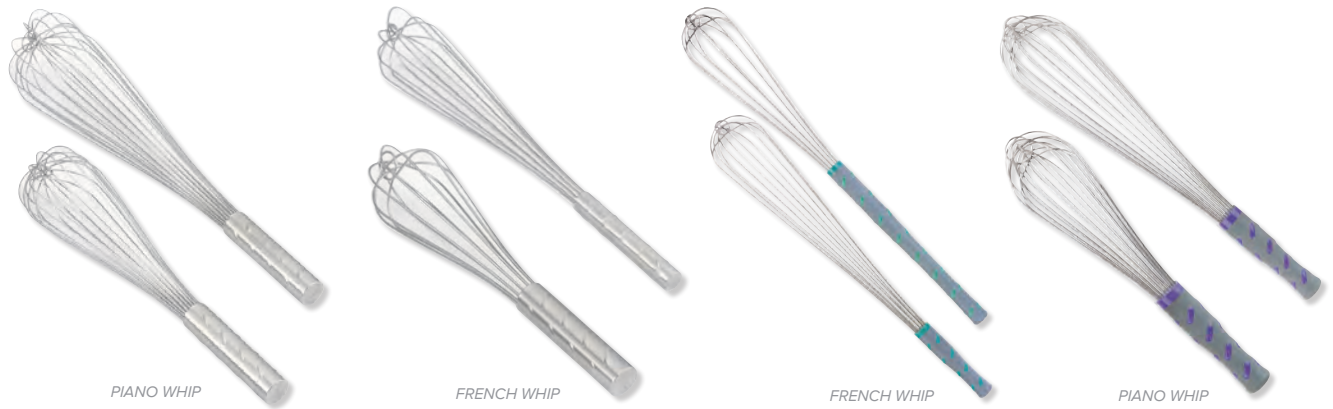

FRENCH ITEM #	PIANO ITEM #	OVERALL LENGTH: IN (CM)	HANDLE LENGTH: IN (CM)	CASE LOT
NYLON HANDLE WHIPS				
47090	47002	10 (25.4)	4 ⁵ / ₁₆ (11.8)	12
47091	47003	12 (30.5)	4 ⁵ / ₁₆ (11.8)	12
47092	47004	14 (35.6)	4 ⁵ / ₁₆ (11.8)	12
47093	47005*	16 (40.6)	5 ⁷ / ₁₆ (13.8)*	12
47094	47006*	18 (45.7)	5 ⁷ / ₁₆ (13.8)*	12
47095	—	20 (50.8)	5 ⁷ / ₁₆ (13.8)	12
47096	—	22 (55.9)	5 ⁷ / ₁₆ (13.8)	12
47097	—	24 (61)	12 (30.5)	12
STAINLESS STEEL HANDLE WHIPS				
47280	47255	10 (25.4)	4 ⁵ / ₁₆ (11.8)	12
47281	47256	12 (30.5)	4 ⁵ / ₁₆ (11.8)	12
47282	47257	14 (35.6)	4 ⁵ / ₁₆ (11.8)	12
47283	47258	16 (40.6)	5 ⁷ / ₁₆ (13.8)	12
47284	47259	18 (45.7)	5 ⁷ / ₁₆ (13.8)	12
47285	—	20 (50.8)	5 ⁷ / ₁₆ (13.8)	12
47286	—	22 (55.9)	6 ⁷ / ₁₆ (16)	12
47287	—	24 (61)	6 ⁷ / ₁₆ (16)	12

*47005 and 47006 handle length is 4⁵/₁₆" (11.8 cm)

CUTTING BOARDS





















Color-Coded Cutting Boards

- High-density, non-porous surface will not stain or absorb juices
- Color-coded system reduces risk of foodborne illness resulting from cross-contamination and is ideal system for maximizing HACCP program
- Separate rack available (52100) – stainless steel, welded construction, holds up to six boards of 3/4" (1.9 cm) thickness



5200080

ITEM #	DESCRIPTION	DIMENSIONS (W X L X H): IN (CM)	CASE LOT
5200011*	– Multi-color set	12 x 18 x 1/2 (30.5 x 45.7 x 1.3)	1
5200211*	– Multi-color set	15 x 20 x 1/2 (38.1 x 50.8 x 1.3)	1
5200311*	– Multi-color set	18 x 24 x 1/2 (45.7 x 60.9 x 1.3)	1
5200000	 White	12 x 18 x 1/2 (30.5 x 45.7 x 1.3)	6
5200200	 White	15 x 20 x 1/2 (38.1 x 50.8 x 1.3)	6
5200080	 Purple	12 x 18 x 1/2 (30.5 x 45.7 x 1.3)	6
5200300	 White	18 x 24 x 1/2 (45.7 x 60.9 x 1.3)	6
5200030	 Blue	12 x 18 x 1/2 (30.5 x 45.7 x 1.3)	6
5200230	 Blue	15 x 20 x 1/2 (38.1 x 50.8 x 1.3)	6
5200330	 Blue	18 x 24 x 1/2 (45.7 x 60.9 x 1.3)	6
5200040	 Red	12 x 18 x 1/2 (30.5 x 45.7 x 1.3)	6
5200240	 Red	15 x 20 x 1/2 (38.1 x 50.8 x 1.3)	6
5200340	 Red	18 x 24 x 1/2 (45.7 x 60.9 x 1.3)	6
5200050	 Yellow	12 x 18 x 1/2 (30.5 x 45.7 x 1.3)	6
5200250	 Yellow	15 x 20 x 1/2 (38.1 x 50.8 x 1.3)	6
5200350	 Yellow	18 x 24 x 1/2 (45.7 x 60.9 x 1.3)	6
5200060	 Tan	12 x 18 x 1/2 (30.5 x 45.7 x 1.3)	6
5200260	 Tan	15 x 20 x 1/2 (38.1 x 50.8 x 1.3)	6
5200360	 Tan	18 x 24 x 1/2 (45.7 x 60.9 x 1.3)	6
5200070	 Green	12 x 18 x 1/2 (30.5 x 45.7 x 1.3)	6
5200270	 Green	15 x 20 x 1/2 (38.1 x 50.8 x 1.3)	6
5200370	 Green	18 x 24 x 1/2 (45.7 x 60.9 x 1.3)	6
52100**	– Cutting board rack	8 x 10 x 9 (20.3 x 25.4 x 27.8)	1

*Includes six boards – one of each color. **Not NSF® certified

Color coding is a convenient and easy way to control food contact and cross-contamination. Ideal for HACCP programs.

 RED: RAW MEATS	 YELLOW: UNCOOKED POULTRY	 TAN: FISH	 GREEN: FRUITS & VEGGIES	 BLUE: COOKED FOODS	 WHITE: DAIRY & MISCELLANEOUS	 PURPLE: ALLERGEN
---	--	--	---	--	---	---

MEASURING TOOLS



Measuring Spoon Sets

- Stainless steel
- Capacities clearly stamped on product in both ounces and milliliters for easy size identification
- Set is secured with stainless steel ring



ITEM #	DESCRIPTION	CASE LOT
SIX-PIECE OVAL MEASURING SPOON SET		
46588	6-piece oval measuring spoon set, 1 Tbsp (15 ml), 2 tsp (10 ml), 1 tsp (5 ml), ½ tsp (2.5 ml), ¼ tsp (1.25 ml), ⅛ tsp (.625 ml)	12
FOUR-PIECE ROUND MEASURING SPOON SETS & BULK MEASURING SPOON		
47118	4-piece round measuring spoon set, 1 Tbsp (15 ml), 1 tsp (5 ml), ½ tsp (2.5 ml), ¼ tsp (1.25 ml)	12
46589	4-piece straight-sided measuring spoon set, 1 Tbsp (15 ml), 2 Tbsp (30 ml), 2 tsp (10 ml), 1 tsp (5 ml)	12
47120	Bulk pack, ½ tsp (2.5 ml)	100

Long-Handle Measuring Spoons

- Long-handle spoons designed for commercial-size spice jars
- Seamless heavy-gauge stainless steel construction
- Capacities clearly stamped for easy identification



ITEM #	CAPACITY: TSP/TBSP (ML)	OVERALL LENGTH: IN (CM)	CASE LOT
LONG-HANDLE MEASURING SPOONS			
47025	¼ tsp (1.25)	15¼ (38.7)	12
47026	½ tsp (2.5)	15¾ (39.1)	12
47027	1 tsp (5)	15¾ (39.6)	12
47028	1 Tbsp (15)	16 (40.7)	12
47029	2 Tbsp (30)	16¾ (41.5)	12
47031*	5-piece measuring spoon set, one of each – 2 Tbsp (30 ml), 1 Tbsp (15 ml), 1 tsp (5 ml), ½ tsp (2.5 ml), ¼ tsp (1.25 ml)		12 Sets
HEAVY-DUTY ROUND MEASURING SPOONS			
47075*	1 tsp (5ml)	6 (15.2)	24
47076*	1 Tbsp (15ml)	6½ (16.4)	24
47077*	2 Tbsp (30ml)	6¾ (17.2)	24
47078*	3-piece measuring spoon set, one of each – 2 Tbsp (30 ml), 1 Tbsp (15 ml), 1 tsp (5 ml)		12 Sets

*Not NSF® certified

Measuring Ladle Set

- Short 6" (15.2 cm) handles easily fit into tight areas
- Bowl shape is ideal for getting into small openings
- Capacities clearly stamped on product in both ounces and milliliters for easy size identification
- Ladle set includes five sizes and is secured with stainless steel ring for convenient storage



ITEM #	DESCRIPTION	CASE LOT
FIVE-PIECE OVAL MEASURING SPOON SET		
44572	5-piece measuring set, one of each – 1 Tbsp (15 ml), 1 tsp (5 ml), ½ tsp (2.5 ml), ¼ tsp (1 ml), ⅛ tsp (0.5 ml)	12

Heavy-Duty Oval Measuring Scoops

- Oval scoops ideal for batters and thick food product
- One-piece construction, heavy-gauge stainless steel
- Capacities clearly stamped for easy identification



47054 – SET



ITEM #	CAPACITY: CUP (ML)	OVERALL LENGTH: IN (CM)	CASE LOT
47055	⅓ cup (30)	8¾ (22.1)	12
47056	¼ cup (60)	9⅞ (23.1)	12
47057	⅓ cup (80)	9¾ (24.7)	12
47058	½ cup (120)	10⅞ (25.5)	12
47059	1 cup (240)	11 (27.9)	12

ITEM #	DESCRIPTION	CASE LOT
47054	Set of one each – ⅓ cup (30 ml), ¼ cup (60 ml), and ½ cup (120 ml)	5 Sets

Four-Piece Measuring Cup Set

- Stainless steel
- Capacities stamped in both standard and metric scales
- Integral spout makes no-spill pouring a breeze
- Dishwasher safe



ITEM #	DESCRIPTION	CASE LOT
47119	4-piece measuring cup set, one of each – 1 cup (240 ml), ½ cup (120 ml), ⅓ cup (80 ml), ¼ cup (60 ml)	12 Sets

Stainless Steel Transfer Vessels and Ramekins

- Spouted bowl provides directional pour – no mess
- Transfer vessels have graduation lines for easy measurement; ramekins have no measurement markings
- One-piece stainless steel construction is durable and easy to clean
- Ideal for dry or wet ingredients



ITEM #	CAPACITY: OZ (ML)	BOWL HEIGHT: IN (CM)	BOWL DIAMETER: IN (CM)	HANDLE LENGTH: IN (CM)	CASE LOT
STAINLESS STEEL TRANSFER VESSELS					
46656	4 (118)	1½ (3.7)	3⅞ (7.9)	1⅜ (2.0)	12
46657	8 (236)	1⅞ (4.9)	3⅞ (9.8)	⅞ (2.2)	12
46658	12 (354)	2⅜ (5.5)	4⅞ (11.2)	1⅞ (2.4)	12
46659	16 (473)	2⅞ (6.1)	4⅞ (12.3)	1⅞ (2.9)	12
STAINLESS STEEL RAMEKINS					
46654	2 (59.1)	1¼ (3.1)	2⅞ (6.1)	1⅜ (2.0)	12
46655	3 (88.7)	1⅜ (3.5)	2¾ (7.1)	⅞ (2.2)	12
46661	4 (118.0)	1½ (3.7)	3 (7.6)	1⅜ (2.0)	12

Four-Quart Urn Cup

- Heavy-gauge 300 series stainless steel
- Graduated in quarts
- Comfortable tubular handle
- Flared edge makes pouring easy



ITEM #	CAPACITY: QT (L)	DIMENSIONS (DIAMETER X H): IN (CM)	CASE LOT
79540	4 (3.8)	7¼ x 6⅞ (18.4 x 15.6)	4

Safety Mate® Measuring Cup & Funnel

- Hang hole for easy storage
- Dishwasher safe
- Ounce markings inside
- Funnel screws onto Traex® wide-mouth squeeze bottles to aid in filling the bottle.
- High-density polyethylene



ITEM #	DESCRIPTION	DIMENSIONS (D X H): IN (CM)	CAPACITY: OZ (ML)	CASE LOT
4903-13	Measuring cup	4 ⁷ / ₈ x 4 ¹ / ₂ (11.4 x 11.4)	16 (473.2)	6
4904-13	Funnel	4 ⁷ / ₈ x 4 ¹ / ₂ (11.4 x 11.4)	16 (473.2)	6

Stainless Steel Graduated Measures

- 18-gauge 300 series stainless steel
- Pouring spout and welded comfortable handle for ease of use
- Easy-to-read graduation marks in ounces and cubic centimeters on inside
- Beveled lip



ITEM #	CAPACITY: QT (L)	CAPACITY: OZ (ML)	HEIGHT: IN (CM)	TOP DIA.: IN (CM)	HANDLE LENGTH: IN (CM)	CASE LOT
95160	½ (0.5)	16 (473.2)	4 ⁵ / ₈ (11.7)	3 ³ / ₄ (9.5)	3 ³ / ₈ (9)	6
95320	1 (0.9)	32 (946.4)	5 ¹ / ₄ (13.3)	4 ⁵ / ₈ (11.6)	3 ³ / ₈ (9)	6
95640	2 (1.9)	64 (1892.7)	6 ³ / ₄ (17.1)	5 ⁵ / ₈ (14)	4 ⁵ / ₈ (10.9)	6

Aluminum Measures

- Impact-resistant 3004 aluminum
- Each embossed bar denotes ¼ of measurement
- Specially designed lip for no-spill pouring
- Welded handles



ITEM #	CAPACITY: QT (L)	OVERALL HEIGHT: IN (CM)	GAUGE	CASE LOT
5350*	¼ (0.24)	3 (7.6)	18	6
68297*	½ (0.5)	4 ³ / ₈ (10.6)	18	6
68296	1 (0.9)	5 ⁷ / ₈ (14)	18	6
68351	2 (1.9)	7 ¹ / ₈ (18)	17	6
68352	4 (3.8)	9 ¹ / ₄ (23.5)	16	6

*Not NSF® certified

Scoops

- Stainless steel scoop has mirror-finished inside, satin-finished outside
- Cast aluminum scoops are one-piece construction with rounded handle and ergonomic finger grips and have capacity stamped on handle



ITEM #	CAPACITY: OZ (ML)	BOWL SIZE: IN (CM)	HANDLE LENGTH: IN (CM)	CASE LOT
STAINLESS STEEL SCOOP				
92110	52 (1537.8)	7 ⁷ / ₈ x 5 ¹ / ₄ (20 x 13.3)	4 (10.2)	6
CAST ALUMINUM SCOOPS				
46890	5 (147.9)	4 ³ / ₄ x 2 ³ / ₈ (12.1 x 6)	—	24
46891	12 (354.9)	6 ¹ / ₄ x 3 ³ / ₈ (15.9 x 7.9)	—	24
5280	18 (532.2)	5 ¹ / ₂ x 3 (14 x 7.6)	—	6
46892	24 (681.9)	8 x 4 (20.3 x 10.2)	—	24
46893	38 (1079.6)	9 x 4 ³ / ₄ (22.9 x 12.1)	—	24
46894	58 (1647.9)	10 ¹ / ₂ x 5 ¹ / ₂ (26.7 x 14)	—	20
46895	85 (2415.1)	12 x 6 ¹ / ₄ (30.5 x 15.9)	—	20

MIXING BOWLS



Mobile Bowl Stands

- All-welded, tubular heavy-gauge stainless steel construction
- No assembly required
- 4" diameter swivel casters with 2 locking casters on 79302 and 79301; 4 locking casters on 79818

79302: 30 QT (28.4 L) MOBILE BOWL STAND WITH TRAY SLIDES

- Holds up to four full-size sheet pans
- Horizontal width between tray risers: 17¼" (44 cm)
- Vertical distance between tray risers: 4¼" (12 cm)



ITEM #	DESCRIPTION	DIMENSIONS: IN (CM)	CASE LOT
79301	Stand w/one 30 qt (28.4 L) 79300 bowl	22½ x 22 x 32¼ (56.8 x 55.9 x 81.9)	1
79001	Open 30 qt stand only	—	1
79300	30 qt (28.4 L) bowl only	21½ x 7½ (54.9 x 20) (dia x h)	1
79302	Stand w/one 30 qt (28.4 L) 79300 bowl	22½ x 22 x 32¼ (56.8 x 55.9 x 81.9)	1
79002	Tray slide 30 qt stand only	—	1
79300	30 qt (28.4 L) bowl only	21½ x 7½ (54.9 x 20) (dia x h)	1
79818	Stand w/one 80 qt (75.7 L) 79800 bowl	30½ x 32½ x 32½ (76.5 x 82.2 x 82.6)	1
79018	80 qt stand only	—	1
79800*	80 qt (75.7 L) bowl only	30½ x 11½ (77.8 x 29.2) (dia x h)	1

*Round bottom

Heavy-Duty Stainless Steel Mixing Bowls

- Heavy-gauge 300 series stainless steel with precise capacities
- Concave bottoms sit flat on countertop
- Consistent size and dimensions make nested storage easy
- Proper weighting prevents tipping when in use



ITEM #	CAPACITY: QT (L)	DIAMETER: IN (CM)	DEPTH: IN (CM)	CASE LOT
68750	½ (0.5)	5¼ (13.3)	2 (5.1)	12
69006	¾ (0.7)	6¼ (15.9)	2½ (6)	6
69014	1½ (1.4)	7¾ (19.7)	3 (7.6)	6
69030	3 (2.8)	9¾ (23.8)	4 (10.2)	6
69040	4 (3.8)	10¾ (26.4)	4½ (10.8)	6
69050	5 (4.7)	11¾ (29.8)	4½ (11.4)	6
69080	8 (7.6)	13¾ (33.7)	5½ (13.7)	3
69130	13 (12.3)	16 (40.6)	6 (15.2)	3
79300*	30 (28.4)	21½ (54.9)	7½ (20)	1
79450*	45 (42.6)	25¼ (64.1)	8½ (21.6)	1
79800**	80 (75.7)	30¾ (77.8)	11½ (29.2)	1

*NSF® certified **Round bottom

Economy Stainless Steel Mixing Bowls

- Bright, mirror-finished stainless steel with beaded edge
- Dishwasher safe
- Bottoms sit flat on countertops



ITEM #	CAPACITY: QT (L)	DIAMETER: IN (CM)	CASE LOT
47930	¾ (0.7)	6½ (16.5)	12
47932	1½ (1.4)	7¾ (19.7)	12
47933	3 (2.8)	9 (22.9)	12
47934	4 (3.8)	10¾ (27.1)	12
47935	5 (4.7)	11¾ (29.8)	12
47938	8 (7.6)	13½ (34.3)	12
47943	13 (12.3)	16 (40.6)	6
47946	16 (15.1)	17½ (44.5)	6
47949	20 (18.9)	19 (48.3)	6

COLANDERS & STRAINERS



Aluminum Colanders

- Heavy-gauge, impact-resistant 3004 aluminum
- Full-ring welded base for added stability
- Thick rim and walls resist denting
- Strong, welded handles make transport easy



ITEM #	CAPACITY: QT (L)	TOP DIAMETER: IN (CM)	OVERALL HEIGHT: IN (CM)	GAUGE	CASE LOT
68298	11 (10.4)	15 ³ / ₁₆ (38.6)	8 ³ / ₁₆ (20.8)	10	2
68350	16 (15.1)	16 ³ / ₁₆ (41.8)	9 ¹ / ₂ (24.1)	10	1

Stainless Steel Colanders

- All-welded stainless steel construction
- Strong side handles for easy transport
- Full-ring base for added stability



ITEM #	CAPACITY: QT (L)	DIAMETER: IN (CM)	DEPTH: IN (CM)	CASE LOT
47963	3 (2.8)	8 ³ / ₄ (22.2)	3 ¹ / ₄ (8.3)	6
47965	5 (4.7)	11 ¹ / ₄ (28.6)	3 ³ / ₄ (9.5)	6
47969	8 (7.6)	13 ³ / ₁₆ (33.8)	4 ¹ / ₄ (10.8)	6
47974	14 (13.2)	16 ³ / ₁₆ (41.1)	5 ¹ / ₂ (14)	6

Wire Mesh Strainers

- Retinned wire mesh strainers with reinforced wire rims for added strength
- Double pan hooks and lacquered wooden handles



FINE ITEM #	FINE DOUBLE ITEM #	MEDIUM ITEM #	MEDIUM DOUBLE ITEM #	DIAMETER: IN (CM)	HANDLE LENGTH: IN (CM)	CASE LOT
47188	47191	47194	47197	6 ¹ / ₄ (15.9)	6 (15.2)	12
47189	47192	47195	47198	8 (20.3)	6 ¹ / ₂ (16.5)	12
47190	47193	47196	47199	10 ¹ / ₄ (26)	9 (22.9)	12

China Caps

- Stainless steel construction with convenient bowl clip
- Fine mesh: $\frac{1}{16}$ " (1.6 mm) perforations; coarse mesh: $\frac{3}{32}$ " (2.4 mm) perforations



FINE ITEM #	COARSE ITEM #	DIAMETER: IN (CM)	DEPTH: IN (CM)	OVERALL LENGTH: IN (CM)	CASE LOT
47166	47176	8 (20.3)	8 (20.3)	18 (45.7)	6
47167	47177	9 $\frac{3}{4}$ (24.8)	10 (25.4)	20 (50.8)	6
47168	47178	12 (30.5)	12 (30.5)	22 (55.9)	6

Professional Strainer & China Cap Strainer

- Hole diameter: $\frac{1}{16}$ " (0.2 cm)
- 4605 ideal for draining pasta, stocks, or vegetables
- 4700 is equipped with two hooks for hanging over the edge of a stock pot



ITEM #	CAPACITY: QT (L)	DIAMETER: IN (CM)	CASE LOT
4605	5 (4.7)	11 $\frac{1}{4}$ (28.6)	4
4700*	5.5 (5.2)	10 $\frac{3}{4}$ (27.3)	4

*NSF® certified

Professional Sieve

- 16" (40.6 cm) frame
- Use for sifting dry ingredients and as a strainer



ITEM #	DESCRIPTION	MESH SIZE	CASE LOT
5270	14" mesh sieve and frame	.018" diameter	1
5270-1	16" sieve frame only	(no screen included)	1
5270142	4" mesh sieve screen only	.035" diameter	1
5270-2	14" mesh screen only	.018" diameter	1
5270182	18" mesh sieve screen only	.015" diameter	1
5270202	22" mesh sieve screen only	.0135" diameter	1

SQUEEZE DISPENSERS

ADDING FLEXIBILITY & VERSATILITY TO YOUR DISPENSING NEEDS



Traex® Squeeze Dispensers COLOR CONFIGURABLE

- Twin Tip™ and Tri Tip™ dispensers allow you to portion condiments more quickly and easily than ever
- 24 oz wide-mouth Color•Mate™ squeeze dispensers available in seven bright, translucent polyethylene colors, allowing you to identify contents and track fill levels at a glance
- Bottles and caps are dishwasher safe
- Bottles are NSF® certified; does not apply to caps

STEP 1

- Locate desired dispenser style in the table below.

STEP 2

- Add desired numerical cap color suffix to replace TT at end of item number (brown 01, red 02, yellow 08, clear 13, blue 44, purple 54, vista green 191). See NOTE below.

STEP 3

- For 24 oz wide-mouth Color•Mate™ squeeze dispensers, add desired numerical bottle and cap color suffix to replace BB and TT after the hyphen (-) (brown 01, red 02, yellow 08, clear 13, blue 44, purple 54, vista green 191). If both bottle and cap are the same color, the last two digits get dropped.

NOTE: When building an item number, the bottle color is indicated by the first 2 digits (BB) after the hyphen (-) and the cap color is the last two digits (TT) (e.g., 2808-1344 indicates a clear bottle with a blue cap). If both bottle and cap colors are the same color, the last two digits get dropped (e.g., 2808-13 indicates a clear bottle with a clear cap).

BOTTLE COLORS – “BB”

Stock Color•Mate™ Translucent Bottles*



TOP COLORS – “TT”

Stock Color•Mate™ Tops



*Available only for 24 oz wide-mouth Color•Mate™ dispensers



ITEM #	DESCRIPTION	BOTTLE COLOR	TOP COLOR	CAPACITY OZ (L)	HEIGHT IN (CM)	DIAMETER IN (CM)	CASE LOT
COLOR•MATE™ SQUEEZE DISPENSERS							
2808-13TT	Single-tip standard bottle opening dispenser	Clear	Select	8 (.24)	7¼ (18.4)	2 (5.1)	12
2812-13TT	Single-tip standard bottle opening dispenser	Clear	Select	12 (.35)	7¼ (18.4)	2⅜ (6)	12
4916-13TT	Single-tip wide-mouth bottle opening Color•Mate dispenser	Clear	Select	16 (.47)	7⅝ (19.4)	2⅛ (7.5)	12
4924-13TT	Single-tip wide-mouth bottle opening Color•Mate dispenser	Clear	Select	24 (.71)	10¼ (26)	2⅛ (7.5)	12
4924C-BBTT**	Single-tip wide-mouth bottle opening Color•Mate dispenser	Select	Select	24 (.71)	10¼ (26)	2⅛ (7.5)	12
4932-13TT	Single-tip wide-mouth bottle opening Color•Mate dispenser	Clear	Select	32 (.95)	10⅝ (26.4)	3¼ (8.3)	12
TWIN TIP™ STANDARD SQUEEZE DISPENSERS							
2208-13TT	Twin Tip standard bottle opening dispenser	Clear	Select	8 (.24)	7¼ (18.4)	2 (5.1)	12
2212-13TT	Twin Tip standard bottle opening dispenser	Clear	Select	12 (.35)	7¼ (18.4)	2⅜ (6)	12
2224-13TT	Twin Tip standard bottle opening dispenser	Clear	Select	24 (.71)	9¾ (24.8)	2⅛ (7.5)	12
TWIN TIP™ & TRI TIP™ WIDE-MOUTH SQUEEZE DISPENSERS							
2316-13TT	Twin Tip wide-mouth bottle opening dispenser	Clear	Select	16 (.47)	7⅝ (18.7)	2⅛ (7.5)	12
2324C-BBTT	Twin Tip wide-mouth bottle opening dispenser	Clear	Select	24 (.71)	9¾ (24.8)	2⅛ (7.5)	12
2332-13TT	Twin Tip wide-mouth bottle opening dispenser	Clear	Select	32 (.95)	10 (25.4)	3⅝ (8.6)	12
3316-13TT	Tri Tip wide-mouth bottle opening dispenser	Clear	Select	16 (.47)	7⅝ (18.7)	2⅛ (7.5)	12
3324-13TT	Tri Tip wide-mouth bottle opening dispenser	Clear	Select	24 (.71)	9¾ (24.8)	2⅛ (7.5)	12
3324C-BBTT**	Tri Tip wide-mouth bottle opening dispenser	Select	Select	24 (.71)	9¾ (24.8)	2⅛ (7.5)	12
3332-13TT	Tri Tip wide-mouth bottle opening dispenser	Clear	Select	32 (.95)	10 (25.4)	3⅝ (8.6)	12

*Note: All items are sold by case lot only. Note: Squeeze dispensers and lids are dishwasher safe but not microwavable. **Only 24 oz capacity wide-mouth bottles are available in translucent colors; all other bottles are available in clear or stated opaque colors.*

Traex® Squeeze Dispensers STANDARD

- Portion condiments more quickly and more easily than ever
- FlowCut™ squeeze dispensers have a patented silicone valve flip top allowing easy squeezing and dispensing with the bottle upside down
- Standard dispensers are a staple of many restaurants the world over
- Bottles and caps are dishwasher safe



BOTTLE & TOP COLORS

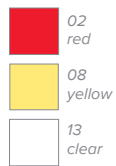

ITEM #	DESCRIPTION	BOTTLE COLOR	TOP COLOR	CAPACITY OZ (L)	HEIGHT IN (CM)	DIAMETER IN (CM)	CASE LOT
STANDARD SQUEEZE DISPENSERS							
2808-02	Single-tip standard bottle opening dispenser	Red	Red	8 (.24)	7¼ (18.4)	2 (5.1)	12
2808-08	Single-tip standard bottle opening dispenser	Yellow	Yellow	8 (.24)	7¼ (18.4)	2 (5.1)	12
2808-13	Single-tip standard bottle opening dispenser	Clear	Clear	8 (.24)	7¼ (18.4)	2 (5.1)	12
2812-02	Single-tip standard bottle opening dispenser	Red	Red	12 (.35)	7¼ (18.4)	2¾ (6)	12
2812-08	Single-tip standard bottle opening dispenser	Yellow	Yellow	12 (.35)	7¼ (18.4)	2¾ (6)	12
2812-13	Single-tip standard bottle opening dispenser	Clear	Clear	12 (.35)	7¼ (18.4)	2¾ (6)	12
2908-13	Closeable single-tip standard bottle opening dispenser*	Clear	Clear	8 (.24)	7¼ (18.4)	2 (5.1)	12
2912-13	Closeable single-tip standard bottle opening dispenser*	Clear	Clear	12 (.35)	7¼ (18.4)	2¾ (6)	12
5224-13	Single-tip standard bottle opening dispenser	Clear	Clear	24 (.71)	9¾ (24.4)	2½ (7.3)	12
5324-13	Closeable single-tip standard bottle opening dispenser*	Clear	Clear	24 (.71)	9¾ (24.4)	2½ (7.3)	12
5232-13	Single-tip standard bottle opening dispenser	Clear	Clear	32 (.95)	9¾ (24.4)	3¼ (8.3)	12
WIDE-MOUTH SQUEEZE DISPENSERS							
4916-02	Single-tip wide-mouth bottle opening dispenser	Red	Red	16 (.47)	7¾ (18.7)	2½⅙ (7.5)	12
4916-08	Single-tip wide-mouth bottle opening dispenser	Yellow	Yellow	16 (.47)	7¾ (18.7)	2½⅙ (7.5)	12
4916-13	Single-tip wide-mouth bottle opening dispenser	Clear	Clear	16 (.47)	7¾ (18.7)	2½⅙ (7.5)	12
4924-02	Single-tip wide-mouth bottle opening dispenser	Red	Red	24 (.71)	10¼ (26)	2½ (7.3)	12
4924-08	Single-tip wide-mouth bottle opening dispenser	Yellow	Yellow	24 (.71)	10¼ (26)	2½ (7.3)	12
4924-13	Single-tip wide-mouth bottle opening dispenser	Clear	Clear	24 (.71)	10¼ (26)	2½ (7.3)	12
4932-02	Single-tip wide-mouth bottle opening dispenser	Red	Red	32 (.95)	10¾ (26.4)	3¼ (8.3)	12
4932-08	Single-tip wide-mouth bottle opening dispenser	Yellow	Yellow	32 (.95)	10¾ (26.4)	3¼ (8.3)	12
4932-13	Single-tip wide-mouth bottle opening dispenser	Clear	Clear	32 (.95)	10¾ (26.4)	3¼ (8.3)	12
5116-13	Closeable single-tip wide-mouth bottle opening dispenser	Clear	Clear	16 (.47)	7¼ (18.4)	2½⅙ (7.5)	12
5124-13	Closeable single-tip wide-mouth bottle opening dispenser	Clear	Clear	24 (.71)	10¼ (26)	2½ (7.3)	12
5132-13	Closeable single-tip wide-mouth bottle opening dispenser	Clear	Clear	32 (.95)	10¾ (26.4)	3¼ (8.3)	12
FLOWCUT™ SQUEEZE DISPENSERS**							
26120-13	FlowCut™ top standard bottle opening dispenser	Clear	White	12 (.35)	6¾ (16.2)	2⅞ (6.2)	12
26240-13	FlowCut™ top standard bottle opening dispenser	Clear	White	24 (.71)	8¾ (22.5)	2½⅙ (7.5)	12
26320-13	FlowCut™ top standard bottle opening dispenser	Clear	White	32 (.95)	9 (22.9)	3¾ (8.6)	12

Note: All items sold by case lot only.

Note: Squeeze dispensers and lids are dishwasher safe but not microwaveable.

*Closeable single-tip caps are available only in clear. **FlowCut™ tops are available only in white.

Traex® Wide-Mouth Squeeze Bottle Converter Kits

- Allow standard-size FlowCut™ and Twin Tip™ caps to be used on wide-mouth bottles
- Bottles and caps are dishwasher safe



ITEM #	DESCRIPTION	CAPACITY: OZ (L)	HEIGHT: IN (CM)	DIAMETER: IN (CM)	CASE LOT
49241-1305	FlowCut cap, clear converter, and clear bottle	24 (.71)	8 ⁷ / ₈ (22.5)	2 ⁵ / ₁₆ (7.5)	12
22016-13	Twin Tip cap, clear converter, and clear bottle	16 (.47)	6 ⁵ / ₈ (16.9)	2 ⁵ / ₁₆ (7.5)	12
22024-13	Twin Tip cap, clear converter, and clear bottle	24 (.71)	8 ⁷ / ₈ (22.5)	2 ⁵ / ₁₆ (7.5)	12
4901-13	Wide-mouth top converter – converts wide-mouth bottle openings to fit standard tops, clear				12

Note: All items are sold by case lot only.

Note: Squeeze dispensers and lids are dishwasher safe but not microwaveable.

Traex Squeeze Dispenser Replacement Caps

- Replacement cap adds flexibility and versatility
- Sold in case lots only
- Caps are dishwasher safe

STOCK COLOR•MATE™ CAPS & STANDARD BOTTLES “TT”

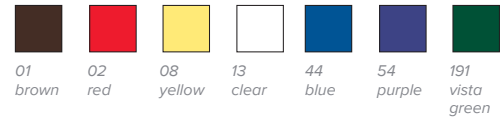

NOTE: Select color by adding color suffix (TT) at the end of product



ITEM #	DESCRIPTION	TOP COLOR	FITS	CASE LOT
REPLACEMENT CAPS FOR STANDARD DISPENSERS				
2813-TT	Single-tip standard bottle opening top	Select	8-32 oz bottles	12
2814-13*	Closeable single-tip standard bottle opening top	Clear	8-32 oz bottles	12
2200-TT	Twin Tip standard bottle opening top	Select	8-32 oz bottles	12
2822-05**	FlowCut top standard bottle opening top	White	8-32 oz bottles	12
REPLACEMENT CAPS FOR WIDE-MOUTH DISPENSERS				
2300-TT	Twin Tip wide-mouth bottle opening top	Select	16, 24, & 32 oz bottles	12
3300-TT	Tri Tip wide-mouth bottle opening top	Select	16, 24, & 32 oz bottles	12
4913-TT	Single-tip wide-mouth bottle opening top	Select	16, 24, & 32 oz bottles	12
4914-13	Closeable single-tip wide-mouth bottle opening top	Clear	16, 24, & 32 oz bottles	12
4901-13	Wide-mouth top converter – converts wide-mouth bottle openings to fit standard tops	Clear	16, 24, & 32 oz bottles	12

Note: All items are sold by case lot only.

*Only available in clear

**Only available in white

Note: Squeeze dispensers and lids are dishwasher safe but not microwaveable.

Slim-Profile Squeeze Dispensers

- No-drip design helps prevent table and counter messes
- Designed for use with item 56116 bottle holder
- Low-density polyethylene
- Ships complete with bottle and cap
- Bottles and caps are dishwasher safe



ITEM #	DESCRIPTION	CAPACITY: OZ (L)	HEIGHT: IN (CM)	DIAMETER: IN (CM)	CASE LOT
52063	Clear	12 (354)	8 ⁷ / ₈ (20.6)	2 ¹ / ₄ (5.7)	12
52064	Red	12 (354)	8 ⁷ / ₈ (20.6)	2 ¹ / ₄ (5.7)	12
52065	Yellow	12 (354)	8 ⁷ / ₈ (20.6)	2 ¹ / ₄ (5.7)	12

Note: All items are sold by case lot only.

Note: Squeeze dispensers and lids are dishwasher safe but not microwaveable.

Sauce Dispenser Holder

- Designed to be dropped into 1/8-size opening in counter
- Accommodates two slim-profile 12 oz squeeze dispensers
- Containers can be placed tip down, ensuring product will drain to the tip, ready to serve
- Attached drip pan will catch leaks



Holder will not accommodate any Traex squeeze dispensers

ITEM #	DESCRIPTION	CASE LOT
56116	Squeeze bottle holder	6

Note: Squeeze dispensers and lids are dishwasher safe but not microwaveable.

Traex® Dripcut® Dredges

- Storage cap (4902-TT) allows accurate tracking of ingredients using FIFO (first in, first out) procedure and safe storage in same dispenser container

ITEM # 4902-TT COLORS ONLY:

Add two-digit color suffix after hyphen (TT)



4907-08



4908-01



4961-13191



4906-32



4905-191

ITEM #	DESCRIPTION	HOLE DIAMETER: IN (CM)	CAPACITY: OZ (L)	DIMENSIONS: IN (CM)	CASE LOT
4961-13191	Clear dredge w/fine green lid	0.055 (.14)	16 (.47)	6¼ x 2½ (16 x 7.3)	12
4961-1332	Clear dredge w/medium beige lid	0.1 (.25)	16 (.47)	6¼ x 2½ (16 x 7.3)	12
4961-1308	Clear dredge w/large yellow lid	0.18 (.46)	16 (.47)	6¼ x 2½ (16 x 7.3)	12
4961-1301	Clear dredge w/extra-large brown lid	0.37 (.94)	16 (.47)	6¼ x 2½ (16 x 7.3)	12
4905-191	Fine green replacement lid	0.055 (.14)	—	—	12
4906-32	Medium beige replacement lid	0.1 (.25)	—	—	12
4907-08	Large yellow replacement lid	0.18 (.46)	—	—	12
4908-01	Extra-large brown replacement lid	0.37 (.94)	—	—	12
4902-TT	Wide-mouth indicator lid – select color from chart above	—	—	—	12

Note: Traex Dripcut Dredges are sold in case lots only.

Note: Squeeze dispensers and lids are dishwasher safe but not microwaveable.

Aluminum and Stainless Steel Dredges

- 18-gauge aluminum or stainless steel
- Available with or without riveted handle
- Ideal for shaking salt, spices, and powdered sugar
- 155 holes (aluminum)



68183

68184

ITEM #	DESCRIPTION	HOLE DIAMETER: IN (CM)	CAPACITY: OZ (L)	OVERALL SIZE: IN (CM)	GAUGE	CASE LOT
ALUMINUM DREDGES						
68181	Large hole without handle	.075 (.19)	10 (295.7)	2¾ x 3¾ (7 x 9.5)	18	12
68182	Large hole with handle	.075 (.19)	10 (295.7)	2¾ x 3¾ (7 x 9.5)	18	12
68183	Small hole without handle	.047 (.12)	10 (295.7)	2¾ x 3¾ (7 x 9.5)	18	12
68184	Small hole with handle	.047 (.12)	10 (295.7)	2¾ x 3¾ (7 x 9.5)	18	12
STAINLESS STEEL DREDGES						
T1041P	With handle	.07 (.17)	10 (295.7)	2.69 x 3.63 (68.3 x 92.1)	24	12
T1042P	Without handle	.078 (.19)	10 (295.7)	2.69 x 4.13 (68.3 x 104.8)	24	12

Traex® Sauce Boss® Portion Control Dispenser

- Settings from ½ oz to ⅓ oz
- Position adjustment is easy; pull the cam pin and rotate the cam to the desired setting
- Clear lid helps reduce the risk of food contamination



ITEM #	DESCRIPTION	CAPACITY: OZ (L)	CASE LOT
2800-31	Sauce Boss with legs, 6⅞" x 10⅞" x 7½" (15.6 X 27.6 X 19.1 cm)	48 (1.4)	1
2802	Sauce Boss parts kit includes octagonal cam pin, octagonal cam, trigger pin, trigger, dispenser bar, piston, check valve, cylinder, octagonal yellow auxiliary cam, and spring		1

Traex Batter Boss® Portion Control Dispenser

- 8 portion control settings dispense 1-3 oz
- Position adjustment is easy; pull the cam pin and rotate the cam to the desired setting
- Clear lid helps reduce the risk of food contamination
- Not recommended for chunky batters



ITEM #	DESCRIPTION	CAPACITY: OZ (L)	CASE LOT
2803-18	Batter Boss with legs, 6⅞" x 10⅞" x 7½" (15.6 X 27.6 X 19.1 cm)	48 (1.4)	1
2805	Batter Boss parts kit includes octagonal cam pin, octagonal cam, trigger pin, trigger, dispenser bar, piston, check valve, spring support plate, and spring		1

Stainless Steel Batter Can

- Heavy-duty, mirror-finished stainless steel
- Ideal for batters during food preparation or table service
- Cool, hollow handle
- Large, hinged cover and easy-pour spout



ITEM #	CAPACITY: QT (L)	HEIGHT: IN (CM)	CASE LOT
46572	2 (1.9)	8½ (21.6)	6

DripCut® Servers with Plastic Jars, Plastic Tops, and Chrome Tops



- Polyethylene jar
- Available with plastic or chrome-plated top
- See Buffet and Tabletop Service, page 244, for additional sizes



4748-18



2748

ITEM #	CAPACITY: OZ (ML)	DIMENSIONS: IN (CM)	CAP COLORS AVAILABLE	CASE LOT
DRIPCUT SERVERS WITH PLASTIC JARS AND PLASTIC TOPS				
632-TT	32 (.95)	4⅞ x 2¾ x 6⅞ (10.3 X 7 X 16.4)	01, 02, 05, 18	6
4748-TT	48 (1.42)	5 x 2¾ x 7¼ (12.7 X 7 X 18.4)	01, 02, 05, 06*, 18	6
4864-TT	64 (1.89)	5⅝ x 2⅝ x 8½ (13.7 X 6.7 X 21.6)	05, 18	6
DRIPCUT SERVERS WITH PLASTIC JARS AND CHROME-PLATED TOPS				
2748	48 (1.42)	5 x 2¾ x 7¼ (12.7 X 7 X 18.4)		6
4064	64 (1.89)	5⅝ x 2⅝ x 8½ (13.7 X 6.7 X 21.6)		6



To specify cap color when ordering your DripCut server, add 2-digit color code suffix (TT)

*4748-06 has a minimum order of 480 pieces

MISCELLANEOUS TOOLS

Flat-Bottom Steak Weights

- Stainless steel
- No crevices to collect food
- Removable silicone handle is heat resistant
- Color-coded removable handles help prevent cross-contamination



50663

ITEM #	DESCRIPTION	DIMENSIONS: IN (CM)	COLOR	CASE LOT
50661	1.6# NSF-certified steak weight, red silicone handle	9 x 4¾ (22.9 x 12.1)	Red	12
50665	1.6# steak weight, yellow silicone handle	9 x 4¾ (22.9 x 12.1)	Yellow	12
50662	2.5# NSF-certified steak weight, red silicone handle	9 x 4¾ (22.9 x 12.1)	Red	12
50663*	Yellow replacement sleeve	—	Yellow	3
50664*	Red replacement sleeve	—	Red	3

*Sold in case lots only

Grid-Bottom Steak Weights

- Wood handle
- Speeds cooking of meats and bacon without curling – saving time and reducing waste



47708

47709

ITEM #	DESCRIPTION	DIMENSIONS: IN (CM)	WEIGHT: LBS (KG)	CASE LOT
47708	Stamped, chrome-plated steel	9 x 4½ (22.9 x 11.4)	2½ (1.13)	12
47709	Cast aluminum	9 x 4¾ (22.9 x 12.1)	1¼ (.57)	12

Meat Tenderizer

- Cast aluminum mallet
- One side has coarse prongs while the other side has fine prongs
- Solid hardwood handle



ITEM #	OVERALL LENGTH: IN (CM)	MALLET SIZE: IN (CM)	CASE LOT
47712	13 (33)	3 x 2½ (7.6 x 6.7)	12

Griddle Stone System

- Will not mar the griddle
- Does not absorb grease or odor
- Optional aluminum griddle stone handle provides a firm grip



ITEM #	DESCRIPTION	DIMENSIONS (L X W X H): IN (CM)	CASE LOT
47710	Stone only	4 x 3½ x 8 (10.2 x 8.9 x 20.3)	12
47711	Aluminum handle only – fits 47710 stone		6

Stainless Skewers

- Stainless steel
- Oval design for easy insertion and additional holding power
- Cleans easily and promotes faster cooking



ITEM #	LENGTH: IN (CM)	CASE LOT
47173	10 (25.4)	36
47174	12 (30.5)	36

French Fry Prep Items

- No bending, breaking, or food traps



ITEM #	DESCRIPTION	HANDLE	DIMENSIONS (L X W X H): IN (CM)	CASE LOT
3672	FryBagger™ scoop	Dual	9 x 8 x 2 (22.9 x 20.3 x 5.1)	6
3670	FryBagger™ scoop	Right	9 x 8 x 2 (22.9 x 20.3 x 5.1)	6
3673	Curly fry bagger	Dual	9 x 8 x 2 (22.9 x 20.3 x 5.1)	6
3681*	Stainless steel rack	—	18 x 10 x 2½ (45.7 x 25.4 x 6.4)	1

* Not NSF® certified

Food Preparation Brushes

- Pastry brushes have boar bristles



ITEM #	DESCRIPTION	DIMENSIONS: IN (CM)	CASE LOT
458	Flat boar bristle pastry brush	1½ x 8¼ (3.8 x 21)	12
461	Flat boar bristle pastry brush	2 x 9 (5.1 x 22.9)	12
463	Flat boar bristle pastry brush	3 x 9¼ (7.6 x 23.5)	12
457-0	Round boar bristle pastry brush	1 x 12 (2.5 x 30.5)	12
483-0	Butcher block brush	9 x 4 (22.9 x 10.2)	1

Stainless Steel Funnels

- Stainless steel
- Hanging ring for easy storage
- Capacity markings for easier selection



ITEM #	CAPACITY: OZ (ML)	TOP DIAMETER: IN (CM)	HEIGHT: IN (CM)	VENT LENGTH: IN (CM)	VENT DIAMETER*: IN (CM)	CASE LOT
84740	6¾ (188.5)	4½ (10.5)	4¾ (11.1)	1½ (3.8)	¾ (1.6)	6
84750	13 (384.5)	5 (12.7)	5¾ (13.7)	1½ (3.8)	¾ (1.6)	6
84760	22¼ (658)	6 (15.2)	6¾ (16.2)	1½ (3.8)	¾ (1.6)	6
84770	32 (946.4)	6¾ (17.1)	7¼ (18.4)	2½ (6.4)	1 (2.5)	6
84780	64 (1892.7)	8¾ (21.3)	8¾ (22.2)	2½ (6.4)	1 (2.5)	6

* Outer vent diameter

Milk Stirrer/Masher

- Perforated blade with extra-long welded handle
- Stainless steel blade and handle



ITEM #	HANDLE LENGTH: IN (CM)	BLADE DIAMETER: IN (CM)	HOLE DIAMETER: IN (CM)	CASE LOT
92320	26 (66)	5 (12.7)	1⅞ (2.7)	6

Check Holders

- Brushed aluminum
- Keeps checks organized



ITEM #	LENGTH: IN (CM)	CASE LOT
2218	18 (45.7)	2
2524	24 (61)	2
2536	36 (91.4)	2
2548	48 (121.9)	2

Pie Markers

- Mark your pies for repeatable portions
- Reduce waste and control costs
- Cast aluminum with plastic handle



ITEM #	DESCRIPTION	DIAMETER: IN (CM)	CASE LOT
47050	6-cut	7⅞ (19.5)	6
47052	8-cut	7 (19.4)	6

Egg Slicer

- Heavy-duty, cast aluminum body
- 10 wires



ITEM #	DIAMETER: IN (CM)	CASE LOT
47040	4½ (11.4)	12

Cheese Cutter

- Heavy-duty chrome-plated handle
- Aluminum roller
- Adjustable rust-proof wire
- Maximum cutting width: 4" (10.1 cm)



ITEM #	WIDTH: IN (CM)	CASE LOT
47700	5 (12.7)	12

Hamburger Patty Mold

- Heavy-duty, chrome-plated



ITEM #	DIAMETER: IN (CM)	CASE LOT
47705*	4¾ (12.1)	12

*Recommended for hamburger patties of 3.5 oz or smaller

DripCut® Grater

- Stainless steel
- Convenient handles on all four sides
- Grate, shred, or mince cheese or vegetables



ITEM #	DIMENSIONS: IN (CM)	CASE LOT
SG-200	9 x 4 x 4 (22.9 x 10.2 x 10.2)	6

Rocker Knife

- Stainless steel knife
- Polypropylene handle
- Ideal for quick and efficient cutting

More pizza accessories available
– see pages 39 and 310-317



ITEM #	LENGTH: IN (CM)	CASE LOT
68720	20 x 4 (51 x 10)	2

Stainless Steel Food Containers

- 300 series stainless steel
- Welded handles
- Smooth, seamless construction makes pans ideal for food preparation



ITEM #	CAPACITY: QT (L)	TOP DIAMETER: IN (CM)	DEPTH: IN (CM)	CASE LOT
72120	12 (11.4)	16½ (41.9)	5½ (13)	3
72240	24 (22.7)	21¾ (55.2)	6¾ (15.5)	3

Covered Ice Cream or Tote Pail

- 22-gauge 300 series stainless steel
- Seamless construction for easy cleaning
- Comes with one cover that can hang on side of pail



ITEM #	DESCRIPTION	CAPACITY: QT (L)	TOP DIAMETER X HEIGHT: IN (CM)	CASE LOT
59200	Covered ice cream tote or pail	20 (18.9)	9½ x 16⅞ (24.2 x 42.7)	1
59202	Extra cover for tote pail	—	—	1

Tapered Dairy or Utility Pails

- 300 series stainless steel
- Pails clean easily to reduce the danger of bacteria growth
- 58161 pail has side tilting handle available
- 58030 hook-on pail cover sold separately



ITEM #	DESCRIPTION	CAPACITY: QT (L)	TOP DIAMETER X HEIGHT: IN (CM)	GAUGE	CASE LOT
TAPERED DAIRY PAILS					
58130	Tapered dairy pail	12½ (11.8)	12 x 10 (30.5 x 25.4)	18	3
58160	Tapered dairy pail	14¾ (13.9)	12 x 10⅞ (30.5 x 25.7)	18	3
58161*	Tapered dairy pail	14¾ (13.9)	12 x 10⅞ (30.5 x 25.7)	18	3
58200	Tapered dairy pail	23 (21.8)	14⅞ x 11⅞ (37.8 x 30.2)	18	3
UTILITY PAILS					
59120	Tapered utility pail	13 (12.3)	11⅞ x 9⅞ (28.9 x 23.8)	20	3
59150	Tapered utility pail	16 (15.1)	11⅞ x 9¾ (30.2 x 25.8)	20	3
HOOK-ON PAIL COVER					
58030	Pail cover for 58161, 58130, 58160			16	3

*With side tilting handle

Traex® Safety Mate™ Insta Chill® Food Coolers

- Rapidly chills food
- Wide mouth with tethered cap
- Durable polycarbonate is dishwasher safe
- Molded-in hook and fill line to denote maximum water fill amount



ITEM #	DESCRIPTION	CAPACITY: QT (L)	DIMENSIONS: IN (CM)	CASE LOT
7024	Insta Chill	4.2 (4)	23½ x 4 (59.7 x 10.2)	1
7022	Insta Chill	2.1 (2)	15½ x 4 (39.4 x 10.2)	1
7023	Replacement tethered cap	—	—	4

Traex Safety Mate™ Ice Porter™ and Dolly

- Durable, break-resistant plastic for long-lasting use
- Pour spout
- Built-in hook for hanging/draining



ITEM #	DESCRIPTION	CAPACITY: GAL (L)	DIMENSIONS: IN (CM)	CASE LOT
7001*	Ice porter	5.75 (21.8)	18 x 8½ (68.1 x 32.2)	1
7005*	Ice porter	4 (15.1)	14 x 8½ (53 x 32.2)	1
7004	Ice porter lid	—	10 x 8¾ x 2 (37.9 x 33.1 x 7.6)	1
7003	Hanging bracket only	—	—	1
1697	Dolly base	—	21 x 21 (79.5 x 79.5)	1
1698	Dolly handle	—	30 x 20½ (113.6 x 77.6)	1

*Made in the USA

Traex® Color•Mate™ Food Storage Boxes

- Affordable and sanitary food storage solution
- Freezer safe
- Dishwasher safe
- Snap-on lids provide 46% increased capacity
- Color coded: red—raw meat, yellow—poultry, blue—seafood, green—produce, white—dairy, purple—allergen

Go to VOLLRATH.com/haccp to learn about using Vollrath color-coded products for HACCP programs.



1535-CXX Combo Sets and Lids

1521-C08

1527-C04

1511-C02

1517-C19

1522-C02

1535BRS6-C19

1500-C04

1500-C04 with 1527-C04

1527-C80 with 1522-C80

ITEM #	PURPLE ITEM #	DESCRIPTION	DIMENSIONS: IN (CM)	CASE LOT
FOOD BOXES AND COVER				
1521-CXX	1521-C80	5" food box	20 x 15 x 5 (50.8 x 38.1 x 12.7)	6
1527-CXX	1527-C80	7" food box	20 x 15 x 7 (50.8 x 38.1 x 17.8)	6
1511-CXX	1511-C80	5" perforated drain box	20 x 15 x 5 (50.8 x 38.1 x 12.7)	6
1517-CXX	—	7" perforated drain box	20 x 15 x 7 (50.8 x 38.1 x 17.8)	6
1522-CXX*	1522-C80	Cover, recessed	21 x 16 x 1 (53.3 x 40.6 x 2.5)	6
1500-CXX	1500-C80	Snap-on lid	22½ x 15½ x 2½ (57.2 x 39.7 x 6.4)	6
1521B-CXX	1521B-C80	5" color food storage box, bulk packed	20 x 15 x 5 (50.8 x 38.1 x 12.7)	150
1527B-CXX	1527B-C80	7" color food storage box, bulk packed	20 x 15 x 7 (50.8 x 38.1 x 17.8)	150
COMBO DRAIN AND BOX SETS				
1551-CXX	—	Combo set includes 5" drain, 5" storage box, snap-on lid	22½ x 15½ x 7½ (57.2 x 39.7 x 19.1)	1
1535-CXX*	1535-C80	Combo set includes 5" drain, 7" storage box, snap-on lid	22½ x 15½ x 9½ (57.2 x 39.7 x 24.1)	1
1535BRS6-CXX*	1535BRS6-C80	Bulk combo set includes 7" box, 5" drain, snap lid, POP sticker	22 x 15½ x 9 (50.8 x 39.4 x 22.9)	30
1501-CXX*	—	Combo set includes 5" drain, 5" storage box, standard lid	20 x 15 x 6 (50.8 x 38.1 x 15.2)	1
1505-CXX*	—	Combo set includes 5" drain, 7" storage box, standard lid	20 x 15 x 8 (50.8 x 38.1 x 20.3)	1
1507-CXX*	—	Combo set includes 7" drain, 7" storage box, standard lid	20 x 15 x 8 (50.8 x 38.1 x 20.3)	1

Select color by adding color suffix (XX) at end of product (red 02, blue 04, white 05, yellow 08, clear 13, green 19)
 * Not available in clear



Sanitary Drain Box

- Impact-resistant, transparent color, high-density polyethylene
- Set includes 5" (12.7 cm) deep drain box and 7" (17.8 cm) deep holding box and cover
- Ideal for thawing and draining fish, poultry, fruits, and vegetables or keeping prepared foods iced before serving



ITEM #	DESCRIPTION	CASE LOT
52618	Complete set drain box kit – transparent, 1 each, 52616, 52657, 52422	1
52616	Perforated drain box only – transparent, 20" x 15" x 5" (50.8 x 38.1 x 12.7 cm)	6



BUFFET & TABLETOP SERVICE

If you believe that we eat with our eyes first, then feast your eyes on Vollrath's tabletop and buffet service line. From casual continental breakfasts to elegant holiday brunches, this collection combines stunning aesthetics with superior functionality to ensure that every meal you serve looks beautiful and tastes fresh.

How to Shop

BUFFET & TABLETOP

Display Service

Designed to look and function great, our display cookware moves from kitchen to buffet line with ease and gives your customers the impression of home-cooked goods.

Pages 179-197



MINI SERVING VESSELS

Pages 179-182



CUBIC MODULAR DISPLAY SYSTEM

Pages 183-188



MIRAMAR® DISPLAY COOKWARE

Pages 189-197

Buffet Service

Our buffet items marry functional design features with elegant styling. Enhance your presentation and rest assured you've chosen durable products.

Pages 198-216



BUFFET & CARVING STATIONS

Page 198



INDUCTION CHAFERS

Pages 199-200



TRADITIONAL CHAFERS

Pages 201-210



CHAFER ACCESSORIES

Pages 211-213



BUFFETWARE

Pages 213-215



BREATH GUARDS

Page 216

Serving Essentials

Transform any table into a serving line with stainless steel serving trays and bowls designed to hold everything from hors d'oeuvres to sandwiches and salads.

Pages 217-226

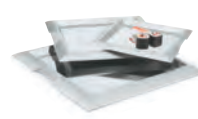

SERVING TRAYS

Pages 217-219



SERVING BOWLS

Pages 220-223



ELEVATION STANDS & BUFFET RISERS

Page 224



PLATE COVERS

Pages 225-226

Beverage Essentials

Keep the glasses full and your customers happy with our complete line of bar and wine service items.

Pages 227-236



BAR SERVICE
Pages 227-229



WINE SERVICE
Pages 230-232



PITCHERS & CREAMERS
Pages 233-236

Tabletop Essentials

Bring durability, beauty and convenience to every table with our extensive selection of tabletop essentials and accessories.

Pages 237-248



BOWLS & RAMEKINS
Pages 237-238



FLATWARE
Pages 239-240



SHAKERS & CADDIES
Pages 241-243



CONDIMENT JARS & SERVERS
Page 244



SPECIALTY SERVICE ITEMS
Pages 245-246



MISCELLANEOUS SERVICE ITEMS
Pages 247-248

Trays & Signage

Keep service moving quickly and smoothly in your cafeteria setting with our durable trays. Then add navigational signs to your restrooms, exits and more.

Pages 248-251



SERVING TRAYS
Pages 248-249



FAST FOOD COMPARTMENT TRAYS
Page 250



SYMBOL SIGNS
Page 251



MINI SERVING VESSELS

VOLLRATH MINI SERVING VESSELS PROVIDE A FUN, WHIMSICAL PRESENTATION OF INDIVIDUAL SERVINGS, APPETIZERS, SIDES, AND DESSERTS.

- An elegant way to control portion sizes
- Enhances plated entrées
- Keeps long buffet lines moving by providing a pre-portioned, “grab and go” serving size for customers
- More sanitary than other buffet setups, as customers touch only their vessel

NEW Cast Iron Mini Cookware

- Collection includes mini round and square fry pans as well as round and oval casserole dishes with lids
- Durable cast iron construction



ITEM #	DESCRIPTION	CAPACITY OZ (ML)	TOP DIAMETER IN (CM)	DIMENSIONS (L X W X H): IN (CM)	CASE LOT
CAST IRON MINI FRY PANS					
59735	Mini Fry Pan	4.8 (143)	4½ (11.4)	–	1
59736	Mini Fry Pan	7.8 (250)	5¾ (14.5)	–	1
59737	Mini Deep Fry Pan	13.5 (398)	6 (15.2)	–	1
59738	Mini Square Fry Pan	14.9 (441)		5¼ (13.5) Square	1
59739	Mini Rectangular Fry Pan	7.3 (216)		4 x 5 (10.2 x 12.7) Rectangle	1
CAST IRON CASSEROLE AND OVAL PANS					
59740	Mini Round Casserole with Lid	8.9 (264)	3½ x 2 (9.2 x 5.1)	–	1
59742	High Round Casserole with Lid	26.4 (782)	5¼ x 2¾ (13.2 x 2.5)	–	1
59741	Mini Oval Pan with Lid	3.3 (98)		4½ x 3¼ x 1 (11.6 x 8.2 x 2.5)	1
59743	Oval Casserole	25.4 (750)		8 x 6 x 1¾ (20.6 x 15.3 x 4.3)	1
59744	High Mini Oval Pan with Lid	10.2 (303)		4½ x 3¾ x 2 (11.7 x 9.5 x 5)	1
REPLACEMENT LIDS FOR CAST IRON COOKWARE					
59740-1	Replacement Lid for 59740 Mini Round Casserole		5 (13)	–	6
59742-1	Replacement Lid for 59742 High Round Casserole		5½ (14.3)	–	6
59741-1	Replacement Lid for 59741 Mini Oval Pan			5 x 3 (12.5 x 8.2)	6
59744-1	Replacement Lid for 59744 High Mini Oval Pan			5 x 3¾ (12.8 x 9.4)	6

STAINLESS STEEL MINI SERVING VESSELS



NEW Stainless Steel Mini Cookware

- Collection includes mini fry pans, casseroles, sauce pans, and roasting pans
- Mirror-finished stainless steel



ITEM #	DESCRIPTION	CAPACITY OZ (ML)	DIAMETER X H	DIAMETER	CASE LOT
FRY PANS					
59759	Mini Fry Pan	8.0 (238)	4 x 1½ (10.2 x 3.3)		12
59760	Mini Fry Pan	10.7 (315)	4½ x 1½ (11.4 x 3.5)		12
59761	Mini Fry Pan	12.7 (376)	5 x 1½ (12.5 x 3.3)		12
59762	Mini Fry Pan	15.1 (446)	5½ x 1½ (14 x 3.5)		12
CASSEROLES					
59771	Mini Round Casserole with Lid – 3.25"	7.5 (223)	3¼ x 1¾ (8.3 x 4.5)		6
59772	Mini Round Casserole with Lid – 3.6"	10.3 (303)	3½ x 2½ (9.2 x 6)		6
59773	Mini Round Casserole with Lid – 4.3"	18.2 (539)	4½ x 2½ (11 x 6.1)		6
59774	Mini Round Casserole with Lid – 4.9"	28.6 (846)	5 x 3 (12.4 x 7.6)		6
REPLACEMENT LIDS					
59771-1	Lid with Knob for 59771 Mini Casserole	–	–	3½ (8.8)	24
59772-1	Lid with Knob for 59772 Mini Casserole	–	–	4 (9.7)	24
59773-1	Lid with Knob for 59773 Mini Casserole	–	–	4½ (11.7)	24
59774-1	Lid with Knob for 59774 Mini Casserole	–	–	5 (12.9)	24
SAUCE PANS					
59775	Mini Sauce Pan	10.4 (308)	3½ x 2 (9.2 x 5)		6
59776	Mini Sauce Pan – Shallow	8.9 (264)	4¼ x 1¾ (11 x 3.6)		6
59777	Mini Sauce Pan	2 (58)	2 x 1 (5.2 x 3)		12
59778	Mini Sauce Pan	5.1 (151)	2¼ x 1¾ (7 x 4.5)		12
59779	Mini Sauce Pan	18.6 (550)	4½ x 2½ (11.3 x 6)		6
ROASTING PANS			DIMENSIONS (L X W X H): IN (CM)		
59767	Mini Roasting Pan – Square	15.5 (459)	4½ x 4½ x 2 (11.5 x 11.5 x 4.7)		12
59768	Mini Roasting Pan – Square	28.2 (833)	5½ x 5½ x 2 (13.7 x 13.7 x 5.5)		12
59769	Mini Roasting Pan – Rectangular	11 (325)	4¾ x 3¾ x 1½ (12.4 x 8.4 x 4)		6
59770	Mini Roasting Pan – Rectangular	17.5 (517)	5¾ x 3¾ x 2 (14.5 x 9.7 x 4.6)		6



Fry Pans



Casseroles



Roasting Pans



Sauce Pans

NEW Stainless Steel Mini Buckets



- Mirror-finished stainless steel
- Hammered and plain styles available

ITEM #	DESCRIPTION	STYLE	CAPACITY OZ (ML)	DIAMETER X HEIGHT IN (CM)	CASE LOT
59782	Mini Bucket with Base	Hammered	29.9 (885)	5 x 5 (12.8 x 12.8)	12
59783	Mini Bucket with Base	Hammered	11.6 (343)	3½ x 3½ (9.2 x 9.2)	12
59784	Mini Bucket with Base	Plain	29.3 (865)	5 x 5 (12.8 x 12.8)	12
59785	Mini Bucket with Base	Plain	11.8 (349)	3½ x 3½ (9.2 x 9.2)	12
59786	Mini Bucket	Plain	6.1 (181)	3 x 3 (7.6 x 7.6)	12

NEW Stainless Steel French Fry Cup



- Satin-finished and hammered-mirror-finished styles available

ITEM #	DESCRIPTION	STYLE	CAPACITY OZ (ML)	DIAMETER X HEIGHT IN (CM)	DIMENSIONS (L X W X H): IN (CM)	CASE LOT
59753	French Fry Cup – Small	Hammered, Straight	13.2 (390.3)	3 x 3 (8.6 x 8.6)	–	12
59754	French Fry Cup – Small	Satin, Straight	13.3 (393.3)	3¼ x 3¼ (8.6 x 8.8)	–	6
59755	French Fry Cup – Large	Hammered, Angled	9.1 (269.1)	3¾ x 4¾ (9.4 x 10.9)	–	12
59756	French Fry Cup – Large	Satin, Angled	9.5 (280.9)	3¾ x 4¾ (9.4 x 10.9)	–	12
59757	French Fry Envelope – Small	Envelope	4.3 (127.2)	–	3 x 1¾ x 3½ (7.6 x 4.3 x 8.9)	12
59758	French Fry Envelope – Large	Envelope	6.4 (189.3)	–	4 x 2 x 3½ (10.2 x 4.8 x 8.9)	12

NEW Stainless Steel Taco Tray



- Increase holding capacity by flipping tray over
- Satin-finished stainless steel

ITEM #	DESCRIPTION	DIMENSIONS (L X W X H): IN (CM)	CASE LOT
59787	Taco Tray – ½ Compartment	5½ x 4 x 2 (13.8 x 10 x 5.1)	12
59788	Taco Tray – ⅔ Compartment	8½ x 4 x 2 (20.7 x 10 x 5.1)	12
59789	Taco Tray – ¾ Compartment	14 x 4 x 2 (35 x 10 x 5.1)	12

NEW Stainless Steel Mini Waste Cans



- Keep your hot-beverage buffet service tidy with mini waste cans
- Satin-finished stainless steel

ITEM #	DESCRIPTION	STYLE	CAPACITY OZ (ML)	DIAMETER X HEIGHT IN (CM)	CASE LOT
59780	Mini Waste Can	Swing top	37.9 (1122)	4½ x 6 (11.8 x 15.5)	1
59781	Mini Waste Can	Swing top	66.1 (1953)	4¾ x 9 (11.8 x 23)	1

NEW Stainless Steel Balti Dishes



- Mirror-finished stainless steel

ITEM #	DESCRIPTION	CAPACITY OZ (ML)	DIAMETER X HEIGHT IN (CM)	CASE LOT
59745	Balti Dish	20 (591.5)	5¼ x 2 (13.2 x 5.3)	6
59746	Balti Dish	31 (916.8)	6 x 2¼ (15.4 x 5.6)	6
59747	Balti Dish	41 (1212.5)	6¾ x 2½ (17 x 6.4)	6
59748	Balti Dish – Shallow	9 (266.2)	4 x 1½ (10.5 x 3.6)	12
59749	Balti Dish – Shallow	18 (532.3)	5¾ x 1½ (14.5 x 4.1)	12
59750	Balti Dish – Shallow	31 (916.8)	6½ x 2 (16.5 x 5.2)	12
59751	Balti Dish – Shallow	40 (1182.9)	7 x 2½ (17.8 x 6)	12
59752	Balti Dish – Shallow	65 (1922.3)	8¼ x 2¾ (20.8 x 7)	6

NEW Stainless Steel Milk Can



- Mirror-finished stainless steel

ITEM #	DESCRIPTION	CAPACITY OZ (ML)	DIAMETER X HEIGHT IN (CM)	CASE LOT
59763	Mini Milk Can	3.1 (91.7)	2 x 2 (4.8 x 5.2)	12
59764	Mini Milk Can	4.9 (144.9)	2 x 3 (5 x 8)	12
59765	Mini Milk Can	16.3 (482)	3 x 4 (8 x 10)	12
59766	Mini Milk Can	19.6 (579.6)	3 x 5 (8 x 12.5)	12

NEW Stainless Steel Specialty Items



- Choose from several unique items to add a creative twist

ITEM #	DESCRIPTION	FINISH	CAPACITY (OZ)	DIMENSIONS (L X W X H) IN (CM)	CASE LOT
59791	Mini Round Ruffled Edge Dish	Mirror	5.6 (166)	3¼ x 1½ (9.8 x 3.8)	12
59796	Mini Round Ribbed Dish	Mirror	2.9 (85)	3¼ x ¾ (7.9 x 2)	12
59798	Mini Inset	Satin	4.7 (139)	2¾ x 2½ (6.5 x 6.5)	12
59797	Cupcake Stand	Satin Top/Mirror Trim & Stand	–	4 x 2¼ (10 x 5.8)	6
59790	Serving Tray	Satin	–	11½ x 4 x ¼ (29 x 10.2 x 0.4)	1

NEW Stainless Steel Mini Woks



- Mirror-finished stainless steel

ITEM #	DESCRIPTION	CAPACITY OZ (ML)	DIAMETER X HEIGHT IN (CM)	CASE LOT
59792	Mini Wok	4.3 (128)	3½ x 1½ (9.3 x 3)	12
59793	Mini Wok	6 (177)	4¼ x 1½ (11 x 3.15)	12
59794	Mini Wok	8 (237)	4¾ x 1¾ (12 x 3.4)	12
59795	Mini Wok	10 (296)	5 x 1½ (12.8 x 3.6)	12



CUBIC MODULAR DISPLAY SYSTEM

ADD EFFICIENT SOPHISTICATION TO YOUR BUFFET PRESENTATION WITH THE CUBIC DISPLAY SYSTEM. THE MODERN SLEEK DESIGN OF CUBIC OFFERS LIMITLESS VERSATILITY WITH CONFIGURATION OPTIONS THAT ALLOW YOU TO CREATE THE IDEAL SETUP FOR EVERY OCCASION.

- Height options maximize the serving area
- Lightweight and portable
- Black components enhance all decors
- Melamine bowls available in multiple colors
- Quick assembly
- Stackability provides easy storage
- Accommodates standard-size pans where applicable
- Only the melamine and acrylic bowls are dishwasher safe. To clean other items, wipe down with damp cloth only.
- See page 71 for our Cubic Display Cases in the Merchandising & Display section



Endless setup options! Visit VOLLRATH.com/cubic for additional setup suggestions and product lists. See page 188 for preconfigured Cubic Display Sets.

NEW Cubic Cutting Board & Tables

- Varying heights create an interesting vertical buffet presentation



ITEM #	DESCRIPTION	DIMENSIONS (L X W X H): IN (CM)	CASE LOT
V904810	Short-height table with small cutting board*	12 ³ / ₄ x 8 ⁵ / ₈ x 4 ¹ / ₁₆ (32.5 x 22 x 12)	1
V904820	Medium-height table with small cutting board*	12 ³ / ₄ x 8 ⁵ / ₈ x 6 ¹ / ₂ (32.5 x 22 x 16.5)	1
V904890	Tall-height table with small cutting board*	12 ³ / ₄ x 8 ⁵ / ₈ x 8 ¹ / ₄ (32.5 x 22 x 21)	1
V904850	Short-height table with full-size cutting board*	20 ⁷ / ₈ x 12 ³ / ₄ x 4 ¹ / ₁₆ (53 x 32.5 x 12)	1
V904804	Replacement small hardwood cutting board (fits short, medium & tall tables)	11 ¹ / ₂ x 7 ⁵ / ₈ x 7 ¹ / ₈ (29.2 x 18.7 x 2.2)	1
V904809	Replacement full-size hardwood cutting board	19 ⁹ / ₁₆ x 11 ¹ / ₂ x 7 ¹ / ₈ (49.7 x 29.2 x 2.2)	1

* Cutting board included with each table



NEW Cubic Shelves & Crossbars

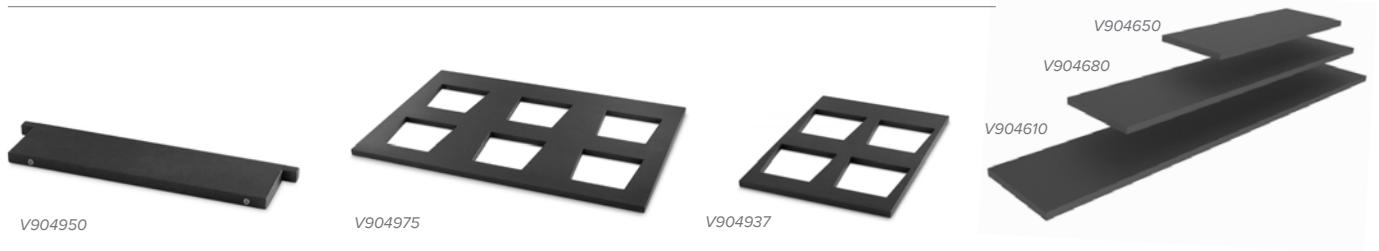

ITEM #	DESCRIPTION	COLOR	DIMENSIONS (L X W X H): IN (CM)	CASE LOT
V904610	Narrow long shelf	Black	39 ³ / ₈ x 7 x ⁹ / ₁₆ (100 x 18 x 1.5)	1
V904612	Wide long shelf	Black	39 ³ / ₈ x 13 ³ / ₄ x ⁹ / ₁₆ (100 x 35 x 1.5)	1
V904650	Narrow short shelf	Black	19 ¹ / ₁₆ x 7 x ⁹ / ₁₆ (50 x 18 x 1.5)	1
V904652	Wide short shelf	Black	19 ¹ / ₁₆ x 13 ³ / ₄ x ⁹ / ₁₆ (50 x 35 x 1.5)	1
V904680	Narrow medium shelf	Black	31 ¹ / ₂ x 7 x ⁹ / ₁₆ (80 x 18 x 1.5)	1
V904682	Wide medium shelf	Black	31 ¹ / ₂ x 13 ³ / ₄ x ⁹ / ₁₆ (80 x 35 x 1.5)	1
V904937	Display template for 4 bowls*	Black	19 ¹ / ₁₆ x 14 ³ / ₄ x ⁹ / ₁₆ (50 x 37.5 x 1.5)	1
V904950	Short crossbar	Black	19 ¹ / ₁₆ x 4 ⁷ / ₈ x ³ / ₄ (50 x 12.4 x 2)	1
V904975	Display template for 6 bowls*	Black	19 ¹ / ₁₆ x 29 ¹ / ₂ x ⁹ / ₁₆ (50 x 75 x 1.5)	1
V904980	Medium crossbar	Black	31 ¹ / ₂ x 4 ⁷ / ₈ x ³ / ₄ (80 x 12.4 x 2)	1
V904990	Long crossbar	Black	39 ³ / ₈ x 4 ⁷ / ₈ x ³ / ₄ (100 x 12.4 x 2)	1

*Designed to accommodate medium-size square melamine bowls (Item V22202 – any color)

NEW Cubic Dispensers/ HOLDERS

ITEM #	DESCRIPTION	COLOR	DIMENSIONS (L X W X H): IN (CM)	CASE LOT
V904720	Wood napkin dispenser	Black	8 ⁵ / ₈ x 8 ⁵ / ₈ x 2 ¹ / ₈ (22 x 22 x 5.5)	1
V904721	Stainless steel tea & sugar bag holder insert only		7 ³ / ₄ x 7 ³ / ₄ x 1 ⁵ / ₁₆ (19.8 x 19.8 x 4.9)	1
V904725	Stainless steel tea & sugar bag holder insert with wood base		8 ⁵ / ₈ x 8 ⁵ / ₈ x 2 ¹ / ₈ (22 x 22 x 5.5)	1



Visit VOLLRATH.com/cubic to download our product reference guide.

NEW Cubic Support Cubes & Lids

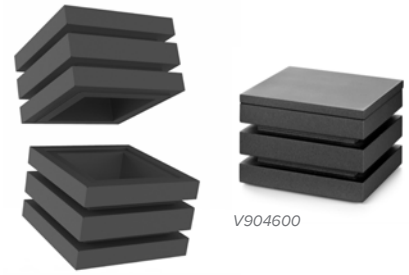

- Stack multiple cubes (up to 3 high) to create additional vertical display space

ITEM #	DESCRIPTION	COLOR	DIMENSIONS (L X W X H) IN (CM)	CASE LOT
V904600	Stackable support cube with lid	Black	9 ¹ / ₁₆ x 9 ¹ / ₁₆ x 6 ¹ / ₂ (23 x 23 x 16.5)	1
V904660	Replacement lid for stackable support cube	Black	9 ¹ / ₁₆ x 9 ¹ / ₁₆ x ⁹ / ₁₆ (23 x 23 x 1.5)	1

NEW Cubic Beverage Dispenser & Accessories

- Designed for use with cold beverages
- Fill the center stainless steel tube with ice cubes to keep beverages cold without watering them down



ITEM #	DESCRIPTION	COLOR	DIMENSIONS (L X W X H) IN (CM)	CAPACITY QT (L)	CASE LOT
V904800	Beverage dispenser assembly		9 ¹ / ₁₆ x 15 ³ / ₁₆ x 19 ⁵ / ₁₆ (23 x 39 x 49.1)	6 ³ / ₄ (6)	1
V904801	Cube holder for beverage dispenser	Black	9 ¹ / ₁₆ x 9 ¹ / ₁₆ x 8 ¹ / ₂ (23 x 23 x 21.5)	—	1
V904806	Drain base & grate for beverage dispenser	Black	9 ¹ / ₁₆ x 7 ¹ / ₂ x ³ / ₄ (23 x 19 x 2)	—	1
V904807	Acrylic beverage dispenser with lid		8 ⁵ / ₈ D x 11 ¹ / ₈ H (22 x 28)	6 ³ / ₄ (6)	1

NEW Cubic Cutting Boards, Platter & Wood Base

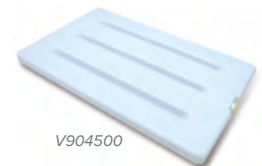
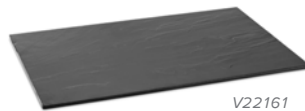

V904200 wood base shown with V904146 bread board and V904300 acrylic lid. Order each item separately.

ITEM #	DESCRIPTION	COLOR	DIMENSIONS (L X W X H): IN (CM)	CASE LOT
V904141	Hardwood display/cutting board*		19 ⁹ / ₁₆ x 11 ¹ / ₂ (50 x 29.2)	1
V904146	Wood bread-cutting/display board		20 ⁷ / ₁₆ x 12 ³ / ₁₆ (52 x 31.5)	1
V904200	Full-size wood base	Black	22 ⁷ / ₁₆ x 14 ⁹ / ₁₆ x 5 ¹ / ₁₆ (57 x 37 x 14.5)	1
V904300	Full-size acrylic roll-top lid		22 ⁷ / ₁₆ x 14 ⁹ / ₁₆ x 6 ⁷ / ₈ (57 x 37 x 17.5)	1
V904500	Cold pack**		18 ¹ / ₁₆ x 10 ⁷ / ₈ x 1 ³ / ₁₆ (47.5 x 27.7 x 3)	1
V22161	Melamine slate/granite display platter		20 ⁷ / ₈ x 12 ³ / ₄ (53 x 32.5)	3

*V904141 (cutting board) needs to be used with the 30002 pan

**V904500 (cold pack) needs to be used with the 30012 pan

NEW Melamine Pedestal Bowls

- Durable melamine bowls in a variety of sizes
- Designed to complement the cubic display system
- Dishwasher safe



ITEM #	DESCRIPTION	COLOR	DIMENSIONS (D X H): IN (CM)	CAPACITY QT (L)	CASE LOT
V22171	Small fluted melamine pedestal bowl	White	8 ⁵ / ₁₆ x 3 ³ / ₄ (20.5 x 9.5)	¹ / ₁₆ (0.9)	3
V22172	Medium fluted melamine pedestal bowl	White	9 ⁵ / ₁₆ x 4 ¹ / ₂ (24.5 x 10.5)	1 ¹ / ₁₆ (1.1)	3
V22173	Large fluted melamine pedestal bowl	White	11 ⁵ / ₁₆ x 4 ¹ / ₂ (28 x 12)	2 ¹ / ₁₆ (1.9)	3

NEW Clear Acrylic Bowls

- See-through acrylic bowls put the focus on the food product
- Ideal for brightly colored fruits or other colorful foods



ITEM #	DESCRIPTION	DIMENSIONS (L X W X H): IN (CM)	CAPACITY: QT (L)	CASE LOT
V927000	Large round acrylic bowl	10 ¹ / ₁₆ x 6 ³ / ₁₆ (25.8 x 15.8)	4.23 (4)	1
V928000	Large square acrylic bowl	11 ³ / ₁₆ x 11 ³ / ₁₆ x 4 ⁷ / ₁₆ (28.5 x 28.5 x 12.4)	4.23 (4)	3
V928001	Small square acrylic bowl	5 ³ / ₄ x 5 ³ / ₄ x 2 ³ / ₄ (14.7 x 14.7 x 7)	0.63 (0.6)	6

NEW Cooling Plates

- Simply place in freezer overnight for hours of cold service
- Use the plate to serve cheese, cold meats, sushi, smoked fish, and more
- Use with the full-size clear acrylic roll-top lid for added safety and cold containment
- Place single-serving bowls or juice glasses on top of the plate to help maintain proper food temperature

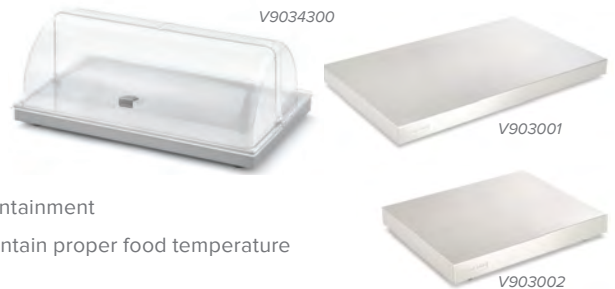

ITEM #	DESCRIPTION	DIMENSIONS (L X W X H): IN (CM)	CASE LOT
V903001	Full-size stainless steel cooling plate	20 ⁷ / ₁₆ x 12 ³ / ₄ (53 x 32.5)	1
V903002	Half-size stainless steel cooling plate	12 ³ / ₄ x 10 ⁷ / ₁₆ (32.5 x 26.5)	1
V904300	Full-size acrylic roll-top lid	22 ¹ / ₁₆ x 14 ⁹ / ₁₆ x 6 ⁷ / ₁₆ (57 x 37 x 17.5 CM)	1

NEW Cubic Accessories

- Use the card holder to display menu items and food types
- Tiered stand ideal for serving multiple food products when space is limited



ITEM #	DESCRIPTION	DIMENSIONS (L X W X H): IN (CM)	CASE LOT
V20072	Acrylic card holder	2 ⁵ / ₁₆ x 2 ⁵ / ₁₆ (6 x 6)	1
V9047900*	Tiered wood stand for ² / ₃ pans	25 ⁵ / ₁₆ x 14 ¹⁵ / ₁₆ x 23 ¹ / ₄ (65.1 x 38 x 59.1)	1

* Accommodates ²/₃-size pans or other fractional-size pans up to 2¹/₂" deep for top and middle shelf and up to 1¹/₄" deep for bottom shelf. Order separately.

NEW Square Melamine Bowls



- Durable melamine bowls in a variety of sizes and colors – add pizzazz to your buffet lineup
- Dishwasher safe

ITEM #	DESCRIPTION	COLOR	DIMENSIONS (L X W X H): IN (CM)	CAPACITY QT (L)	CASE LOT
V22211	XXS bowl	White	2¾ x 2¾ x 1⅝ (7 x 7 x 4.2)	⅛ (0.09)	24
V22200	XS bowl	White	3½ x 3½ x 2⅝ (9 x 9 x 5.5)	⅛ (0.15)	12
V22201	Small bowl	White	5⅝ x 5⅝ x 2¾ (13 x 13 x 7)	⅝ (0.6)	6
V22202	Medium bowl*	White	7⅞ x 7⅞ x 3⅝ (18 x 18 x 8.5)	1⅞ (1.5)	6
V22203	Large bowl	White	9½ x 9½ x 3⅝ (24 x 24 x 10)	3⅞ (3)	3
V22204	XL bowl	White	11⅞ x 11⅞ x 4½ (30 x 30 x 11.5)	6⅞ (6.26)	3

ITEM #	DESCRIPTION	COLOR	DIMENSIONS (L X W X H): IN (CM)	CAPACITY QT (L)	CASE LOT
V2220020	XS bowl	Black	3½ x 3½ x 2⅝ (9 x 9 x 5.5)	⅛ (0.15)	12
V2220220	Medium bowl*	Black	7⅞ x 7⅞ x 3⅝ (18 x 18 x 8.5)	1⅞ (1.5)	6
V2220320	Large bowl	Black	9½ x 9½ x 3⅝ (24 x 24 x 10)	3⅞ (3)	3



ITEM #	DESCRIPTION	COLOR	DIMENSIONS (L X W X H): IN (CM)	CAPACITY QT (L)	CASE LOT
V2220030	XS bowl	Blue	3½ x 3½ x 2⅝ (9 x 9 x 5.5)	⅛ (0.15)	12
V2220230	Medium bowl*	Blue	7⅞ x 7⅞ x 3⅝ (18 x 18 x 8.5)	1⅞ (1.5)	6
V2220330	Large bowl	Blue	9½ x 9½ x 3⅝ (24 x 24 x 10)	3⅞ (3)	3



ITEM #	DESCRIPTION	COLOR	DIMENSIONS (L X W X H): IN (CM)	CAPACITY QT (L)	CASE LOT
V2220040	XS bowl	Red	3½ x 3½ x 2⅝ (9 x 9 x 5.5)	⅛ (0.15)	12
V2220240	Medium bowl*	Red	7⅞ x 7⅞ x 3⅝ (18 x 18 x 8.5)	1⅞ (1.5)	6
V2220340	Large bowl	Red	9½ x 9½ x 3⅝ (24 x 24 x 10)	3⅞ (3)	3



ITEM #	DESCRIPTION	COLOR	DIMENSIONS (L X W X H): IN (CM)	CAPACITY QT (L)	CASE LOT
V2220050	XS bowl	Yellow	3½ x 3½ x 2⅝ (9 x 9 x 5.5)	⅛ (0.15)	12
V2220250	Medium bowl*	Yellow	7⅞ x 7⅞ x 3⅝ (18 x 18 x 8.5)	1⅞ (1.5)	6
V2220350	Large bowl	Yellow	9½ x 9½ x 3⅝ (24 x 24 x 10)	3⅞ (3)	3



ITEM #	DESCRIPTION	COLOR	DIMENSIONS (L X W X H): IN (CM)	CAPACITY QT (L)	CASE LOT
V2220070	XS bowl	Green	3½ x 3½ x 2⅝ (9 x 9 x 5.5)	⅛ (0.15)	12
V2220270	Medium bowl*	Green	7⅞ x 7⅞ x 3⅝ (18 x 18 x 8.5)	1⅞ (1.5)	6
V2220370	Large bowl	Green	9½ x 9½ x 3⅝ (24 x 24 x 10)	3⅞ (3)	3



*Medium bowl fits into cubic display templates

NEW Cubic Set – Basic

- Preconfigured set for quick ordering and simple setup
- 4 black stackable support cubes with lids
- 2 black wood display shelves for 4 bowls
- 1 black medium wood crossbar
- 8 white medium square melamine bowls
- 1 -black narrow medium wood shelf



ITEM #	DESCRIPTION	DIMENSIONS (L X W X H): IN (CM)	CASE LOT
V904333	Basic Cubic Display Set	56 x 23 x 15 (142.2 x 58.4 x 38.1)	1

NEW Cubic Set with Beverage

- Preconfigured set for quick ordering and simple setup
- 7 black stackable support cubes with lids
- 1 black wood display shelf for 4 bowls
- 1 black wood crossbar
- 1 black wide, short wood crossbar
- 1 black narrow medium shelf
- 1 half-size stainless steel cooling plate
- 5 white medium square melamine bowls
- 2 white large round acrylic bowls
- 3 white extra-small square melamine bowls
- 1 full-size acrylic roll-top
- 1 black wooden base
- 1 wood bread-cutting/display board
- 1 beverage dispenser



ITEM #	DESCRIPTION	DIMENSIONS (L X W X H): IN (CM)	CASE LOT
V904444	Cubic Display Beverage Set	99 x 23 x 28 (251.5 x 58.4 x 71.1)	1

NEW Cubic Set with Cutting Boards

- Preconfigured set for quick ordering and simple setup
- 6 black stackable support cubes with lids
- 1 black wood display shelf for 6 Bowls
- 1 black wide medium wood crossbar
- 1 black medium wood crossbar
- 1 melamine slate/granite platter
- 1 medium-height table with cutting board
- 1 short-height table with cutting board
- 1 full-size stainless steel cooling plate
- 1 white medium fluted melamine bowl
- 2 white small fluted melamine bowls
- 8 white medium square melamine bowls
- 4 white extra-small square melamine bowls
- 2 white extra-extra-small square melamine bowls



ITEM #	DESCRIPTION	DIMENSIONS (L X W X H): IN (CM)	CASE LOT
V904555	Cubic display with cutting boards	115 x 23 x 28 (292.1 x 58.4 x 71.1)	1



MIRAMAR® DISPLAY COOKWARE

GIVE THE IMPRESSION OF A HOME-COOKED MEAL WITH AN ELEGANT PRESENTATION.



- Extremely durable – thick 3-ply construction provides induction compatibility and will last a lifetime
- Cookware items have satin-finished interior and exterior with mirror-finished handles
- Au Gratins, Food Pans, and French Oven have full mirrored finish
- Unique handle design allows for easy removal from templates
- Handle design serves as a convenient cover rest on Casseroles, Sauté Pan, and French Omelet Pan
- Use in any typical display areas: heated shelves, steam table with templates, and induction ranges ... but with quality seen only in commercial cookware



Miramar Casseroles

ITEM #	DESCRIPTION	CAPACITY: QT (L)	LENGTH: IN (CM)	WIDTH: IN (CM)	HEIGHT: IN (CM)	CASE LOT
49410	Casserole 3 qt with low dome cover	3 (2.9)	7 $\frac{1}{8}$ (20)	7 $\frac{1}{8}$ (20)	3 $\frac{3}{4}$ (9.5)	1
49411	Casserole 5 qt with low dome cover	5 (4.8)	9 $\frac{1}{2}$ (24.1)	9 $\frac{1}{2}$ (24.1)	4 $\frac{7}{8}$ (11.3)	1
49441 NEW	Casserole 7 qt with low dome cover	7 (6.6)	10 $\frac{5}{8}$ (26.2)	10 $\frac{5}{8}$ (26.2)	5 $\frac{7}{8}$ (13.8)	1

NEW Miramar Oval Au Gratins



ITEM #	DESCRIPTION	CAPACITY: QT (L)	LENGTH: IN (CM)	WIDTH: IN (CM)	HEIGHT: IN (CM)	CASE LOT
49420	Oval au gratin 10"	1 $\frac{3}{8}$ (1.7)	10 (25.4)	7 $\frac{1}{2}$ (19.1)	2 $\frac{1}{8}$ (5.2)	1
49412*	Oval au gratin 12"	2 $\frac{5}{8}$ (2.5)	12 (30.5)	8 $\frac{1}{2}$ (21.6)	2 (5.1)	1
49452 NEW	Oval au gratin 12"	5.1 (4.9)	12 (30.5)	8 $\frac{1}{2}$ (21.6)	4 (10.2)	1
49442 NEW	Oval au gratin 16"	3 $\frac{3}{4}$ (3.5)	16 (40.6)	9 (22.9)	2 (5.1)	1
49445 NEW	Oval au gratin 16"	7 $\frac{7}{8}$ (6.9)	16 (40.6)	9 (22.9)	4 (10.2)	1

Miramar Sauté Pans



ITEM #	DESCRIPTION	CAPACITY: QT (L)	LENGTH: IN (CM)	WIDTH: IN (CM)	HEIGHT: IN (CM)	CASE LOT
49416	Sauté pan 8"	1 $\frac{1}{4}$ (1.2)	8 (20.3)	8 (20.3)	2 (5.1)	1
49413	Sauté pan 10"	2 $\frac{1}{4}$ (2.1)	10 $\frac{1}{4}$ (26)	10 $\frac{1}{4}$ (26)	1 $\frac{1}{4}$ (4.8)	1

Miramar French Omelet Pans



ITEM #	DESCRIPTION	CAPACITY: QT (L)	LENGTH: IN (CM)	WIDTH: IN (CM)	HEIGHT: IN (CM)	CASE LOT
49417	French omelet pan 8"	1 $\frac{1}{4}$ (1.7)	8 (20.3)	8 (20.3)	2 $\frac{3}{8}$ (6)	1
49424	French omelet pan 10"	3 $\frac{3}{8}$ (2.9)	10 $\frac{1}{4}$ (26)	10 $\frac{1}{4}$ (26)	2 $\frac{3}{8}$ (6)	1

Miramar® Stir Fry Cookware

49418



49428



ITEM #	DESCRIPTION	CAPACITY: QT (L)	LENGTH: IN (CM)	WIDTH: IN (CM)	HEIGHT: IN (CM)	CASE LOT
49418	Stir fry pan 12"	5 $\frac{3}{16}$ (4.9)	11 $\frac{7}{8}$ (30.2)	11 $\frac{1}{8}$ (30.2)	3 $\frac{1}{8}$ (9.4)	1
49428	Stir fry server 13"	6 $\frac{5}{16}$ (6)	12 $\frac{5}{8}$ (32.1)	12 $\frac{5}{8}$ (32.1)	3 $\frac{1}{8}$ (9.2)	1

Miramar Brazier Pan

49425



ITEM #	DESCRIPTION	CAPACITY: QT (L)	LENGTH: IN (CM)	WIDTH: IN (CM)	HEIGHT: IN (CM)	CASE LOT
49425	Brazier pan 12"	6 $\frac{5}{16}$ (6)	11 $\frac{3}{8}$ (30)	11 $\frac{1}{8}$ (30)	3 $\frac{1}{2}$ (8.9)	1

Miramar Sauce Pans

49430



49414



ITEM #	DESCRIPTION	CAPACITY: QT (L)	LENGTH: IN (CM)	WIDTH: IN (CM)	HEIGHT: IN (CM)	CASE LOT
49430	Sauce pan 1 qt	1 (0.9)	5 $\frac{1}{2}$ (14)	5 $\frac{1}{2}$ (14)	2 $\frac{1}{8}$ (6.8)	1
49414	Sauce pan 2 qt	2 (1.9)	6 $\frac{1}{4}$ (15.9)	6 $\frac{1}{4}$ (15.9)	3 $\frac{1}{4}$ (9.5)	1

Miramar Food Pans

49432



49433



ITEM #	DESCRIPTION	CAPACITY: QT (L)	LENGTH: IN (CM)	WIDTH: IN (CM)	HEIGHT: IN (CM)	CASE LOT
49434	Small food pan w/o handle	2.8 (2.6)	11.6 (29 $\frac{1}{2}$)	9.3 (23.6)	2 (5.1)	1
49435	Small food pan w/ handle	2.8 (2.6)	11.6 (29 $\frac{1}{2}$)	9.3 (23.6)	2 (5.1)	1
49432	Large food pan w/o handle	4.6 (4.4)	14.7 (37.3)	11.8 (30)	2 (5.1)	1
49433	Large food pan w/ handle	4.6 (4.4)	14.7 (37.3)	11.8 (30)	2 (5.1)	1

Miramar French Oven

49431



ITEM #	DESCRIPTION	CAPACITY: QT (L)	LENGTH: IN (CM)	WIDTH: IN (CM)	HEIGHT: IN (CM)	CASE LOT
49431	French oven 7 qt w/ cover	7 (6.6)	14.3 (36.3)	11.1 (28.2)	3.8 (9.7)	1

Miramar Dome Covers

49429



49415



ITEM #	DESCRIPTION	LENGTH: IN (CM)	WIDTH: IN (CM)	HEIGHT: IN (CM)	CASE LOT
49429	High dome cover 13" fits 49428	14 (35.6)	14 (35.6)	4 $\frac{1}{4}$ (12)	1
49426	High dome cover 12" fits 49418 and 49425	12 $\frac{3}{4}$ (32.4)	12 $\frac{3}{4}$ (32.4)	4 (10.2)	1
49415	Low dome cover fits 49414	6 $\frac{1}{8}$ (16.8)	6 $\frac{1}{8}$ (16.8)	2 (5.1)	1
49427	Low dome cover fits 49430	5 $\frac{7}{8}$ (14.9)	5 $\frac{7}{8}$ (14.9)	2 (5.1)	1
49419	Low dome cover 8" fits 49416 and 49417	8 (20.3)	8 (20.3)	2 (5.1)	1
49423	Low dome cover 10" fits 49413 and 49424	10 $\frac{3}{4}$ (27.3)	10 $\frac{3}{4}$ (27.3)	2 (5.1)	1



MIRAMAR® COOKWARE TEMPLATES

- All templates are made to order unless otherwise noted with an asterisk – please allow 3 weeks for production

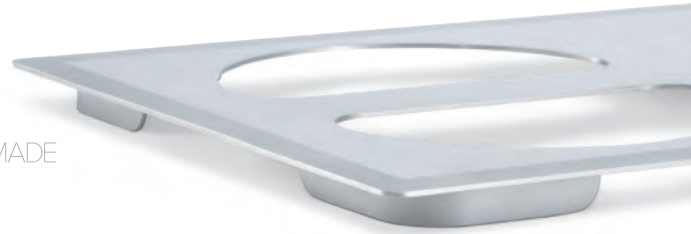

Single-Size Templates



OVERALL DIMENSIONS 21 $\frac{1}{8}$ " X 12 $\frac{3}{4}$ " (53.6 X 32.4 CM)

	ITEM #	COLOR	CUT-OUT DESCRIPTION	ACCOMMODATES	CASE LOT
	8242014*		One large and one small round, stainless steel plain	(1) 49411 and (1) 49410	1
	8242016		One large and one small round, stainless steel satin edge	(1) 49411 and (1) 49410	1
	8242010		One large and one small round, night sky	(1) 49411 and (1) 49410	1
	8242020		One large and one small round, white stone	(1) 49411 and (1) 49410	1
	8242114		One large round, stainless steel plain	(1) 49424	1
	8242116		One large round, stainless steel satin edge	(1) 49424	1
	8242110		One large round, night sky	(1) 49424	1
	8242120		One large round, white stone	(1) 49424	1
	8242214		Two small round, stainless steel plain	(2) 49430	1
	8242216		Two small round, stainless steel satin edge	(2) 49430	1
	8242314		One large oval, stainless steel plain	(1) 49412 or 49452	1
	8242316		One large oval, stainless steel satin edge	(1) 49412 or 49452	1
	8242310		One large oval, night sky	(1) 49412 or 49452	1
	8242320		One large oval, white stone	(1) 49412 or 49452	1
	8242414		One large and one small round, stainless steel plain	(1) 49430 and (1) 49424	1
	8242416		One large and one small round, stainless steel satin edge	(1) 49430 and (1) 49424	1
	8242514*		Two large rounds, stainless steel plain	(2) 49411	1
	8242516		Two large rounds, stainless steel satin edge	(2) 49411	1

*In stock. For all other templates, please allow 3 weeks for production.

	ITEM #	COLOR	DESCRIPTION	ACCOMMODATES	CASE LOT
	8243414		One large and one small round, stainless steel	(1) 49441 and (1) 49414	1
	8243416		One large and one small round, stainless steel satin edge	(1) 49441 and (1) 49414	1
	8243410		One large and one small round, night sky	(1) 49441 and (1) 49414	1
	8243420		One large and one small round, white stone	(1) 49441 and (1) 49414	1
	8243418		One large and one small round, solid black	(1) 49441 and (1) 49414	1
	8243422		One large and one small round, brown granite	(1) 49441 and (1) 49414	1
	8243424		One large and one small round, grey granite	(1) 49441 and (1) 49414	1
		8243514		One large round, stainless steel	(1) 49441
8243516			One large round, stainless steel satin edge	(1) 49441	1
8243510			One large round, night sky	(1) 49441	1
8243520			One large round, white stone	(1) 49441	1
8243518			One large round, solid black	(1) 49441	1
8243522			One large round, brown granite	(1) 49441	1
8243524		One large round, grey granite	(1) 49441	1	
	8243614		One large oval, stainless steel	(1) 49442 or (1) 49445	1
	8243616		One large oval, stainless steel satin edge	(1) 49442 or (1) 49445	1
	8243610		One large oval, night sky	(1) 49442 or (1) 49445	1
	8243620		One large oval, white stone	(1) 49442 or (1) 49445	1
	8243618		One large oval, solid black	(1) 49442 or (1) 49445	1
	8243622		One large oval, brown granite	(1) 49442 or (1) 49445	1
	8243624		One large oval, grey granite	(1) 49442 or (1) 49445	1

Single-Size Templates, Continued

OVERALL DIMENSIONS 21 $\frac{1}{8}$ " X 12 $\frac{3}{4}$ " (53.6 X 32.4 CM)

- All templates are made to order unless otherwise noted with an asterisk – please allow 3 weeks for production

	ITEM #	COLOR	CUT-OUT DESCRIPTION	ACCOMMODATES	CASE LOT
	8242614*	■	One large round, stainless steel plain	(1) 49418	1
	8242616	■	One large round, stainless steel satin edge	(1) 49418	1
	8242610	■	One large round, night sky	(1) 49418	1
	8242620	■	One large round, white stone	(1) 49418	1
	8242714*	■	One French oven pan, stainless steel plain	(1) 49431	1
	8242716	■	One French oven pan, stainless steel satin edge	(1) 49431	1
	8242710	■	One French oven pan, night sky	(1) 49431	1
	8242720	■	One French oven pan, white stone	(1) 49431	1
	8242814*	■	One small food pan, stainless steel plain	(1) 49435 or (1) 49434	1
	8242816	■	One small food pan, stainless steel satin edge	(1) 49435 or (1) 49434	1
	8242810	■	One small food pan, night sky	(1) 49435 or (1) 49434	1
	8242820	■	One small food pan, white stone	(1) 49435 or (1) 49434	1
	8242914*	■	One large food pan, stainless steel plain	(1) 49433 or (1) 49432	1
	8242916	■	One large food pan, stainless steel satin edge	(1) 49433 or (1) 49432	1
	8243014*	■	Two small food pans, stainless steel plain	(2) 49435	1
	8243016	■	Two small food pans, stainless steel satin edge	(2) 49435	1
	8243114*	■	One large and one medium oval, stainless steel plain	(1) 49420 and (1) 49412	1
	8243116	■	One large and one medium oval, stainless steel satin edge	(1) 49420 and (1) 49412	1
	8243214*	■	Two medium oval, stainless steel plain	(2) 49420	1
	8243216	■	Two medium oval, stainless steel satin edge	(2) 49420	1
	8243218	■	Two medium oval, solid black	(2) 49420	1
	8243220	■	Two medium oval, white stone	(2) 49420	1
	8243314	■	One large and one medium round, stainless steel plain	(1) 49424 and (1) 49417	1
	8243316	■	One large and one medium round, stainless steel satin edge	(1) 49424 and (1) 49417	1

*In stock. For all other items, please allow 3 weeks for production.

Double-Size Templates

OVERALL DIMENSIONS 21 $\frac{1}{8}$ " X 25 $\frac{5}{8}$ " (53.6 X 65 CM)

Visit [VOLLRATH.com/miramar](https://www.vollrath.com/miramar) to view the Miramar® Template Configurator.

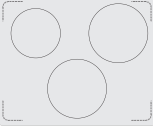
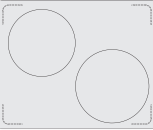
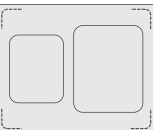
	ITEM #	COLOR	CUT-OUT DESCRIPTION	ACCOMMODATES	CASE LOT
	8250614	■	Three rounds, stainless steel plain	(1) 49410, (1) 49413, and (1) 49411	1
	8250616	■	Three rounds, stainless steel satin edge	(1) 49410, (1) 49413, and (1) 49411	1
	8250714	■	Two large rounds, stainless steel plain	(1) 49425 and (1) 49418	1
	8250716	■	Two large rounds, stainless steel satin edge	(1) 49425 and (1) 49418	1
	8250814	■	One large and one small food pan, stainless steel plain	(1) 49435 and (1) 49433 or (1) 49432	1
	8250816	■	One large and one small food pan, stainless steel satin edge	(1) 49435 and (1) 49433 or (1) 49432	1



MIRAMAR® CONTEMPORARY PANS

Miramar Contemporary Steam Table Pans & Lids

- Snap-on lid eliminates the need for plastic wrap and other aids in food prep
- Clear polypropylene provides great food visibility
- Stackable for easy storage in coolers
- Dishwasher safe
- Decorative options to dress up your buffet
- High-quality stainless steel, brushed finish



ITEM #	DESCRIPTION	CAPACITY: QT (L)	DIMENSIONS: IN (CM)	CASE LOT
40003	5¼ x 5¼ brushed stainless steel pan	1 (.9)	5¼ x 5¼ x 4¾ (14.6 x 14.6 x 12.1)	1
40004	5¼ x 11½ brushed stainless steel pan	2.5 (2.4)	5¼ x 11½ x 4¾ (14.6 x 29.2 x 12.1)	1
40005	11½ x 9¼ brushed stainless steel pan	4.5 (4.3)	11½ x 9¼ x 4¾ (29.2 x 23.5 x 12.1)	1
40006	11½ x 19 brushed stainless steel pan	6 (5.7)	11½ x 19 x 3¾ (29.2 x 48.3 x 7.9)	1
CONTEMPORARY PAN LIDS				
40030	Clear plastic lid, fits 40003	–	–	6
40040	Clear plastic lid, fits 40004	–	–	6
40050	Clear plastic lid, fits 40005	–	–	6
40060	Clear plastic lid, fits 40006	–	–	6

Miramar Contemporary Templates



	ITEM #	COLOR	DESCRIPTION	DIMENSIONS: IN (CM)	CASE LOT
	8240018	Black	Solid black blank thermoset template	12 x 20 (30.5 x 50.8)	1
	8240020	White	White stone blank thermoset template	12 x 20 (30.5 x 50.8)	1
	8240022	Brown	Brown granite blank thermoset template	12 x 20 (30.5 x 50.8)	1
	8240024	Grey	Grey granite blank thermoset template	12 x 20 (30.5 x 50.8)	1
	8240014*	Stainless Steel	Stainless steel plain blank template	12 x 20 (30.5 x 50.8)	1
	8244018	Black	Accommodates 1 each 40006, solid black	12 x 20 (30.5 x 50.8)	1
	8244020	White	Accommodates 1 each 40006, white stone	12 x 20 (30.5 x 50.8)	1
	8244022	Brown	Accommodates 1 each 40006, brown granite	12 x 20 (30.5 x 50.8)	1
	8244024	Grey	Accommodates 1 each 40006, grey granite	12 x 20 (30.5 x 50.8)	1
	8244014*	Stainless Steel	Accommodates 1 each 40006, stainless steel	12 x 20 (30.5 x 50.8)	1
	8244118	Black	Accommodates 2 each 40005, solid black	12 x 20 (30.5 x 50.8)	1
	8244120	White	Accommodates 2 each 40005, white stone	12 x 20 (30.5 x 50.8)	1
	8244122	Brown	Accommodates 2 each 40005, brown granite	12 x 20 (30.5 x 50.8)	1
	8244124	Grey	Accommodates 2 each 40005, grey granite	12 x 20 (30.5 x 50.8)	1
	8244114*	Stainless Steel	Accommodates 2 each 40005, stainless steel	12 x 20 (30.5 x 50.8)	1
	8244218	Black	Accommodates 3 each 40004, solid black	12 x 20 (30.5 x 50.8)	1
	8244220	White	Accommodates 3 each 40004, white stone	12 x 20 (30.5 x 50.8)	1
	8244222	Brown	Accommodates 3 each 40004, brown granite	12 x 20 (30.5 x 50.8)	1
	8244224	Grey	Accommodates 3 each 40004, grey granite	12 x 20 (30.5 x 50.8)	1
	8244214*	Stainless Steel	Accommodates 3 each 40004, stainless steel	12 x 20 (30.5 x 50.8)	1
	8244318	Black	Accommodates 6 each 40003, solid black	12 x 20 (30.5 x 50.8)	1
	8244320	White	Accommodates 6 each 40003, white stone	12 x 20 (30.5 x 50.8)	1
	8244322	Brown	Accommodates 6 each 40003, brown granite	12 x 20 (30.5 x 50.8)	1
	8244324	Grey	Accommodates 6 each 40003, grey granite	12 x 20 (30.5 x 50.8)	1
	8244314*	Stainless Steel	Accommodates 6 each 40003, stainless steel	12 x 20 (30.5 x 50.8)	1

*In stock. For all other items, please allow 3 weeks for production.



MIRAMAR® DECORATIVE PANS

ADD FLAIR TO YOUR SERVING PRESENTATION

- Decorative pans have a stylish embossed pattern on rim adding elegance and style to your buffet presentation
- Durable and easy to clean
- Multiple shapes and capacities for a variety of foods and more appealing presentations
- Various-sized pans to be used with templates on pages 191-192
- Dishwasher safe
- High-quality stainless steel, high-polish finish



8230010 with
8231610 inset cover

Miramar Soup Insets & Covers

ITEM #	DESCRIPTION	CAPACITY: QT (L)	DIMENSIONS (DIA X H): IN (CM)	CASE LOT
INSETS				
8230010	Soup inset / Fits opening 8.41"	7 (6.6)	10½ x 8¾ (26.7 x 21.1)	1
8231220*	Soup inset / Fits opening 10.25"	10 (9.5)	12 x 7¾ (30.5 x 20.0)	1
HINGED COVERS				
8231620**	Brass knob hinged cover for 7 qt (6.6 L) soup inset	—	10¾ x 3 (26.8 x 7.6)	1
8231610**	Chrome knob hinged cover for 7 qt (6.6 L) soup inset	—	10¾ x 3 (26.8 x 7.6)	1
8261720**	Brass knob hinged cover for 10 qt (9.5 L) soup inset	—	12 x 3 (30.5 x 7.6)	1
8261710**	Chrome knob hinged cover for 10 qt (9.5 L) soup inset	—	12 x 3 (30.5 x 7.6)	1

Note: Material thickness – Suffix "10" denotes 1.5 mm and suffix "20" denotes 1.2 mm
*No embossed pattern on rim **Not NSF® certified

Miramar Decorative Oval & Half Oval Pans



ITEM #	DESCRIPTION	CAPACITY: QT (L)	DIMENSIONS (L X W X H): IN (CM)	CASE LOT
8230210	Small oval – 2½" (6.4 cm) deep	2 (1.9)	13¾ x 8¾ x 2½ (33.3 x 22.5 x 6.4)	1
8230110	Small oval – 4" (10.2 cm) deep	3.4 (3.2)	13¾ x 8¾ x 4 (33.3 x 22.5 x 10.2)	1
8231420	Large oval – 2" (5.1 cm) deep	3 (2.8)	19¾ x 11¾ x 2 (48.4 x 30.2 x 5.1)	1
8231320	Large oval – 4" (10.2 cm) deep	6.4 (6.1)	19¾ x 11¾ x 4 (48.4 x 30.2 x 10.2)	1
8230620	Half oval – 4½" (10.8 cm) deep	1.7 (1.6)	8¾ x 6½ x 4½ (22.5 x 16.5 x 11.4)	1

Miramar Decorative Casserole Pans



8203510

ITEM #	DESCRIPTION	DEPTH: IN (CM)	CAPACITY: QT (L)	DIMENSIONS (L X W X H): IN (CM)	CASE LOT
8203510	Casserole pan 8"	2½ (6.4)	2.4 (2.3)	12 x 13 x 2½ (30.5 x 33.0 x 6.4)	1
8230510	Casserole pan 10"	4 (10.2)	4.1 (3.9)	12 x 13 x 4 (30.5 x 33.0 x 10.2)	1

MIRAMAR® STAINLESS STEEL DECORATIVE & PLAIN PANS

- 18-8 high-polished stainless steel construction – durable and easy to clean
- Multiple shapes and capacities for a variety of foods and more appealing presentations
- Decorative pans have a stylish embossed pattern on rim adding elegance and style to your buffet presentation
- Various-sized pans fit in standard well opening
- Dishwasher safe



Miramar Decorative Full-Size Pans



8230305

DECORATIVE ITEM #	PLAIN ITEM #	DESCRIPTION	CAPACITY: QT (L)	DIMENSIONS (L X W X H): IN (CM)	CASE LOT
8230310*	8230305*	Full-size - 1¼" (3.2 cm) deep	2.9 (2.7)	21½ x 13⅝ x 1¼ (54.6 x 33.8 x 3.2)	1
8230410*	8230405*	Full-size - 2½" (6.4 cm) deep	6.3 (6.6)	21½ x 13⅝ x 2½ (54.6 x 33.8 x 6.4)	1

Miramar Decorative 3/4-Size Pans



8231520

DECORATIVE ITEM #	PLAIN ITEM #	DESCRIPTION	CAPACITY: QT (L)	DIMENSIONS (L X W X H): IN (CM)	CASE LOT
8231520	—	¾-size 2¼" (5.7 cm) deep	4.1 (3.9)	19½ x 12 x 2¼ (49.5 x 30.5 x 5.7)	1

Miramar Decorative Half-Size Pans



8230720

DECORATIVE ITEM #	PLAIN ITEM #	DESCRIPTION	CAPACITY: QT (L)	DIMENSIONS (L X W X H): IN (CM)	CASE LOT
8231810	—	Half-size 1" (2.5 cm) deep	1.4 (1.5)	13⅝ x 10⅝ x 1 (33.2 x 27.0 x 2.5)	1
8231820	—	Half-size 1½" (3.8 cm) deep	2.15 (2)	13⅝ x 10⅝ x 1½ (33.2 x 27.0 x 3.8)	1
8230720	8230705	Half-size 2¾" (7.0 cm) deep	3.4 (3.2)	13⅝ x 10⅝ x 2¾ (33.2 x 27.0 x 7.0)	1

Miramar Decorative Half-Size Long Pans



8230920

DECORATIVE ITEM #	PLAIN ITEM #	DESCRIPTION	CAPACITY: QT (L)	DIMENSIONS (L X W X H): IN (CM)	CASE LOT
8230820	8230805	Half-size long 2¾" (7.0 cm) deep	3 (2.8)	20⅝ x 6½ x 2¾ (53.2 x 16.5 x 7.0)	1
8230920	8230905	Half-size long 4" (10.2 cm) deep	4.4 (4.1)	20⅝ x 6½ x 4 (53.2 x 16.5 x 10.2)	1

Miramar Decorative Third-Size Pans



8231120

DECORATIVE ITEM #	PLAIN ITEM #	DESCRIPTION	CAPACITY: QT (L)	DIMENSIONS (L X W X H): IN (CM)	CASE LOT
8231120	8231105	Third-size 2½" (6.4 cm) deep	1.9 (1.8)	13⅝ x 7 x 2½ (33.2 x 17.8 x 6.4)	1
8231020	8231005	Third-size 4" (10.2 cm) deep	2.7 (2.5)	13⅝ x 7 x 4 (33.2 x 17.8 x 10.2)	1

Miramar Decorative Sixth-Size Pans



8262220

8266205

DECORATIVE ITEM #	PLAIN ITEM #	DESCRIPTION	CAPACITY: QT (L)	DIMENSIONS (L X W X H): IN (CM)	CASE LOT
8262220	8262205	Sixth-size 2½" (6.4 cm) deep	.86 (.81)	6½ x 7 x 2½ (16.5 x 17.8 x 6.4)	1
8264220	8264205	Sixth-size 4" (10.2 cm) deep	1.24 (1.17)	6½ x 7 x 4 (16.5 x 17.8 x 10.2)	1
8266220	8266205	Sixth-size 6" (15.2 cm) deep	1.79 (1.7)	6½ x 7 x 6 (16.5 x 17.8 x 15.2)	1

See adaptor bars on page 100



MIRAMAR® STAINLESS STEEL TEMPLATES

Double-Well Miramar Templates

- Designed for Miramar Display Pans (see pages 194-195)
- 21½" x 25¾" (53.6 x 65.4 cm)
- All templates are made to order unless otherwise noted with an asterisk – please allow 3 weeks for production

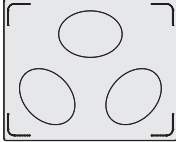
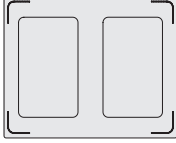
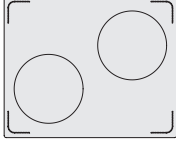
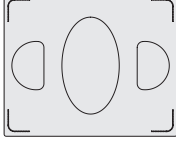
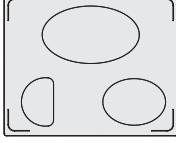

Find easy steps for ordering Miramar templates and view cut-out dimensions at VOLLRATH.com/miramar.

	ITEM #	COLOR	CUT-OUT DESCRIPTION	ACCOMMODATES	CASE LOT
	8250014	■	Blank double template, stainless steel plain	–	1
	8250016	■	Blank double template, stainless steel satin edge	–	1
	8250114	■	Three small ovals, stainless steel plain	(3) 8230110 or (3) 8230210	1
	8250116	■	Three small ovals, stainless steel satin edge	(3) 8230110 or (3) 8230210	1
	8250214	■	Two rectangles (¾ size), stainless steel plain	(2) 8231520	1
	8250216	■	Two rectangles (¾ size), stainless steel satin edge	(2) 8231520	1
	8250314	■	Two casseroles, stainless steel plain	(2) 8203510 or (2) 8230510	1
	8250316	■	Two casseroles, stainless steel satin edge	(2) 8203510 or (2) 8230510	1
	8250414	■	One large oval and two half ovals, stainless steel plain	(1) 8231420 or 8231320 and (1) 8230620	1
	8250416	■	One large oval and two half ovals, stainless steel satin edge	(1) 8231420 or 8231320 and (1) 8230620	1
	8250514	■	One large oval, one small oval, and one half oval, stainless steel plain	(1) 8231420 or 8231320 and (1) 8230110 or 8230210 and (1) 8230620	1
	8250516	■	One large oval, one small oval, and one half oval, stainless steel satin edge	(1) 8231420 or 8231320 and (1) 8230110 or 8230210 and (1) 8230620	1



Visit VOLLRATH.com/miramar



Miramar Template Configurator for Quick Selection

Single-Well Miramar® Templates

- Designed for Miramar Display Pans (see pages 194-195)
- All templates are made to order unless otherwise noted with an asterisk – please allow 3 weeks for production



To view cut-out dimensions and the Miramar Template Configurator, visit VOLLRATH.com/miramar.

	ITEM #	COLOR	DESCRIPTION	DIMENSIONS: IN (CM)	CASE LOT
	8240014*		Stainless steel plain blank template	21½ x 12¾ (53.6 x 32.4)	1
	8240020		White stone blank thermoset template	21½ x 12¾ (53.6 x 32.4)	1
	8240016*		Stainless steel satin edge blank template	21½ x 12¾ (53.6 x 32.4)	1
	8240010*		Night sky blank thermoset template	21½ x 12¾ (53.6 x 32.4)	1
	8240022		Brown granite blank thermoset template	21½ x 12¾ (53.6 x 32.4)	1
	8220014		Stainless steel plain half-size blank template	10½ x 12¾ (26.7 x 32.4)	1
	8220010*		Night sky half-size blank thermoset template	10½ x 12¾ (26.7 x 32.4)	1

*In stock. For all other items, please allow 3 weeks for production.

	ITEM #	COLOR	CUT-OUT DESCRIPTION	ACCOMMODATES	CASE LOT
	8240114		One large oval, stainless steel plain	(1) 8231420 or (1) 8231320	1
	8240116*		One large oval, stainless steel satin edge	(1) 8231420 or (1) 8231320	1
	8240110		One large oval, night sky	(1) 8231420 or (1) 8231320	1
	8240120		One large oval, white stone	(1) 8231420 or (1) 8231320	1
	8240214		Oval and ½ oval, stainless steel plain	(1) 8230110 or 8230210 and (1) 8230620	1
	8240216		Oval and ½ oval, stainless steel satin edge	(1) 8230110 or 8230210 and (1) 8230620	1
	8240210		Oval and ½ oval, night sky	(1) 8230110 or 8230210 and (1) 8230620	1
	8240220		Oval and ½ oval, white stone	(1) 8230110 or 8230210 and (1) 8230620	1
	8240314		Two small ovals, stainless steel plain	(2) 8230110 or 8230210	1
	8240316*		Two small ovals, stainless steel satin edge	(2) 8230110 or 8230210	1
	8240310		Two small ovals, night sky	(2) 8230110 or 8230210	1
	8240320		Two small ovals, white stone	(2) 8230110 or 8230210	1
	8240322		Two small ovals, brown granite	(2) 8230110 or 8230210	1
	8240414		One oval and two half ovals, stainless steel plain	(1) 8230110 or 8230210 and (2) 8230620	1
	8240416*		One oval and two half ovals, stainless steel satin edge	(1) 8230110 or 8230210 and (2) 8230620	1
	8240410		One oval and two half ovals, night sky	(1) 8230110 or 8230210 and (2) 8230620	1
	8240420		One oval and two half ovals, white stone	(1) 8230110 or 8230210 and (2) 8230620	1
	8240514		One rectangle (¾ size), stainless steel plain	(1) 8231520	1
	8240516		One rectangle (¾ size), stainless steel satin edge	(1) 8231520	1
	8240510		One rectangle (¾ size), night sky	(1) 8231520	1
	8240520		One rectangle (¾ size), white stone	(1) 8231520	1
	8240614		One medium round, stainless steel plain	(1) 8230010	1
	8240616		One medium round, stainless steel satin edge	(1) 8230010	1
	8240610		One medium round, night sky	(1) 8230010	1
	8240620		One medium round, white stone	(1) 8230010	1
	8240714		One large round, stainless steel plain	(1) 8231220	1
	8240716		One large round, stainless steel satin edge	(1) 8231220	1
	8240710		One large round, night sky	(1) 8231220	1
	8240720		One large round, white stone	(1) 8231220	1
	8241314		Four ½ ovals, stainless steel plain	(4) 8230620	1
	8241316		Four ½ ovals, stainless steel satin edge	(4) 8230620	1
	8241310		Four ½ ovals, night sky	(4) 8230620	1
	8241320		Four ½ ovals, white stone	(4) 8230620	1
	8241414		One casserole and one half oval, stainless steel plain	(1) 8203510 or 8230510 and (1) 8230620	1
	8241416		One casserole and one half oval, stainless steel satin edge	(1) 8203510 or 8230510 and (1) 8230620	1
	8241410		One casserole and one half oval, night sky	(1) 8203510 or 8230510 and (1) 8230620	1
	8241420		One casserole and one half oval, white stone	(1) 8203510 or 8230510 and (1) 8230620	1
	8241914		Six 4¼" (10.8 cm) bain maries, stainless steel plain	(6) 78710	1
	8241916		Six 4¼" (10.8 cm) bain maries, stainless steel satin edge	(6) 78710	1
	8241910		Six 4¼" (10.8 cm) bain maries, night sky	(6) 78710	1
	8241920		Six 4¼" (10.8 cm) bain maries, white stone	(6) 78710	1

*In stock. For all other items, please allow 3 weeks for production.



BUFFET & CARVING STATIONS

Contoured Buffet Stations

- Stylish yet flexible option for hot-food buffet serving
- Available in three elegant finishes
- High-quality and durable aluminum and chrome-plated steel



4667480
SMALL BUFFET STATION
shown with Griddle Pan
(sold separately)



4667580
LARGE BUFFET STATION
shown with Miramar® cookware
(sold separately)



4667680
INDUCTION BUFFET STATION
shown with Mirage® Cadet
Induction Range (sold separately)

ITEM #	DESCRIPTION	DIMENSIONS (L X W X H): IN (CM)	CASE LOT
4667470	Small buffet station w/wire grill – brown	16 x 16 x 7½ (40.6 x 40.6 x 19.1)	1
4667475	Small buffet station w/wire grill – black	16 x 16 x 7½ (40.6 x 40.6 x 19.1)	1
4667480	Small buffet station w/wire grill – natural	16 x 16 x 7½ (40.6 x 40.6 x 19.1)	1
4667570	Large buffet station w/wire grill – brown	21 x 16 x 7½ (53.3 x 40.6 x 19.1)	1
4667575	Large buffet station w/wire grill – black	21 x 16 x 7½ (53.3 x 40.6 x 19.1)	1
4667580	Large buffet station w/wire grill – natural	21 x 16 x 7½ (53.3 x 40.6 x 19.1)	1
4667670	Induction buffet station – brown	18¼ x 15½ x 8 (46.4 x 40.3 x 20.3)	1
4667675	Induction buffet station – black	18¼ x 15½ x 8 (46.4 x 40.3 x 20.3)	1
4667680	Induction buffet station – natural	18¼ x 15½ x 8 (46.4 x 40.3 x 20.3)	1
77540*	Griddle pan for 16" x 16" buffet station	16 x 17½ x 1⅞ (40.6 x 44.3 x 3.7)	1
77541*	Griddle pan for 21" x 16" buffet station	24¾ x 17¼ x 1⅞ (62.4 x 43.8 x 3.7)	1

*NSF® certified and induction ready

Contoured Platters & Stands

- Elegant and versatile serving platters with the durability of melamine
- Platters available in two sizes and dishwasher safe
- Medium platter has accompanying chrome-plated steel riser stands available in three heights



ITEM #	DESCRIPTION	DIMENSIONS (L X W X H): IN (CM)	CASE LOT
46291*	Large melamine platter	22 x 13¾ x 1¼ (55.9 x 34.8 x 3)	1
46292*	Medium melamine platter	14½ x 9 x 1¼ (35.9 x 22.9 x 3)	1
46251	3" stand for medium platter	16½ x 8¾ x 3 (41.9 x 21.3 x 7.6)	1
46252	5" stand for medium platter	16½ x 8¾ x 5 (41.9 x 21.3 x 12.7)	1
46253	7" stand for medium platter	16½ x 8¾ x 7 (41.9 x 21.3 x 17.8)	1

*NSF® certified

Contoured Carving Station

- Attractive carving station with lamps for additional heat while serving
- Heavy-duty steel frame, chrome plated
- Stylish solid-surface base and top
- Dual heat lamps, 250 watts each, NSF® certified, shatter resistant
- Spun aluminum shades for heat dissipation
- Clear tempered-glass customer breath guard
- Knife-friendly, dishwasher-safe cutting board included, NSF® certified
- Recessed base channels liquids into removable drip pan
- Super Pan V® third-size drip pan included
- Rubber feet provide stability and protect tabletop
- On/off lighted switch on base
- 6 ft. cord with plug



ITEM #	DESCRIPTION	DIMENSIONS (W X D X H): IN (CM)	VOLTAGE	CASE LOT
46670	Contoured carving station	24 x 22 x 27 (61 x 56 x 68.6)	120 AC	1
25154	Contoured carving station cutting board only, black	21½ x 16¾ x ½ (54.1 x 42.5 x 1.27)	–	1
72242	Infrared bulb, white, 250W	–	–	1

Cutting board included and sold separately

MIRAGE® INDUCTION CHAFERS

NEW INDUCTION READY, PROFESSIONAL PRESENTATION

- Chafers accept standard-size steam table pans
- Designed to work with Vollrath induction buffet warmers and other Vollrath induction products
- Available with mirror-finished stainless steel or glass cover
- Automatic slow-close feature keeps food hot
- For use with induction warmers or as traditional chafers in the optional stands
- Stands accept both chafer heater (sold separately) or canned fuel



4644025



4644015



4644055



4644050

ITEM #	DESCRIPTION	MAXIMUM OPEN HEIGHT: IN (CM)	DIMENSIONS (W X D X H): IN (CM)	TOTE BOX	CASE LOT
4644010	Full-size induction chafer w/ added glass lid and 30022 food pan	24 (61)	23 x 18 ³ / ₁₆ x 7 ¹ / ₂ (58.4 x 46.5 x 19.8)	52647	1
4644015	Full-size induction chafer w/ added stainless lid and 30022 food pan	24 (61)	23 x 18 ³ / ₁₆ x 7 ¹ / ₂ (58.4 x 46.5 x 19.8)	52647	1
4644020	2/3-size induction chafer w/ added glass lid and 30122 food pan	24 (61)	16 x 18 ¹ / ₄ x 6 ¹⁶ / ₂₅ (40.6 x 46.4 x 17)	52647	1
4644025	2/3-size induction chafer w/ added stainless lid and 30122 food pan	24 (61)	16 x 18 ¹ / ₄ x 6 ¹⁶ / ₂₅ (40.6 x 46.4 x 17)	52647	1
4644050	Stand for full-size induction chafer	—	16 ³ / ₄ x 24 ¹ / ₂ x 9 ² / ₅ (42.6 x 63.1 x 23.9)	—	1
4644055	Stand for 2/3-size induction chafer	—	16 ¹ / ₂ x 16 ¹ / ₂ x 9 ³ / ₁₆ (41.9 x 41.1 x 23.6)	—	1

* Depth is back of hinge to handle

ITEM #	DESCRIPTION	DIMENSIONS (LxW): IN (CM)	CASE LOT
NON-SLIP MATS			
4644070	Non-slip mat – full-size	16 x 8 (40.6 x 20.3)	1
4644080	Non-slip mat – 2/3 size	9 x 8 (22.9 x 20.3)	1

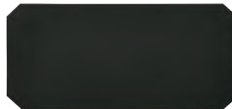

DESIGNED SPECIFICALLY FOR INDUCTION BUFFET WARMERS – MIRAGE INDUCTION CHAFERS

- Chafers accept standard-size steam table pans
- Available with mirror-finished stainless steel or glass cover
- Automatic slow-close feature keeps food hot

See pages 53-54 for product details.





INTRIGUE® INDUCTION CHAFERS



ELEGANT LOW-PROFILE DESIGN OFFERS THE BEST FOOD PRESENTATION

- Induction ready
- Mirror-finished stainless steel
- Glass-top version allows viewing of food without opening chafer – maintaining food quality
- Removable cover with baffle; “stay put” hinge design holds cover in closed, 45°, or 90° position
- Reinforced bracket with rubber table feet for longer life and to keep chafer in place
- Dripless cover and pans keep condensation off food and tabletop
- Available with mirror-finished stainless steel or porcelain food pans



46125



46120



46132



46134



46130



46131



49130

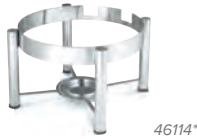

46114*



46549*



46113*



46112*

*Stands accept canned fuel or Vollrath's universal chafer heater

ITEM #	DESCRIPTION	CAPACITY: QT (L)	DIMENSIONS	CASE LOT	TOTE BOX
ROUND INTRIGUE® INDUCTION CHAFERS			W X H: IN (CM)		
46120	Solid top S/S chafer with brass trim and porcelain food pan	6 (5.8)	15½ x 3½ (39.4 x 8.0)	1	52645
46121	Solid top S/S chafer with brass trim and S/S food pan	6 (5.8)	15½ x 3½ (39.4 x 8.0)	1	52645
46122	Solid top S/S chafer with S/S trim and porcelain food pan	6 (5.8)	15½ x 3½ (39.4 x 8.0)	1	52645
46123	Solid top S/S chafer with S/S trim and S/S food pan	6 (5.8)	15½ x 3½ (39.4 x 8.0)	1	52645
46124	Glass top S/S chafer with brass trim and S/S food pan	6 (5.8)	15½ x 3½ (39.4 x 8.0)	1	52645
46125	Glass top S/S chafer with S/S trim and S/S food pan	6 (5.8)	15½ x 3½ (39.4 x 8.0)	1	52645
46130	Porcelain food pan	4.24 (4)	15½ x 2¾ (39.4 x 7.0)	1	—
49130	Divided porcelain food pan	3.75 (3.5)	15½ x 2¾ (38.4 x 6.2)	1	—
46131	S/S food pan	5.92 (5.6)	15½ x 2¾ (39.4 x 7.0)	1	—
46549	Black chafer stand*	—	—	1	—
46114	S/S stand*	—	—	1	—
SQUARE INTRIGUE® INDUCTION CHAFERS			W X H X D: IN (CM)		
46133	Solid top S/S chafer with S/S trim and porcelain food pan	6 (5.8)	15.43 x 16.23 x 8.01 (39.2 x 41.2 x 20.3)	1	—
46132	Solid top S/S chafer with S/S trim and S/S food pan	6 (5.8)	15.43 x 16.23 x 8.01 (39.2 x 41.2 x 20.3)	1	—
46134	Glass top S/S chafer with S/S trim and S/S food pan	6 (5.8)	15.43 x 16.23 x 6.9 (39.2 x 41.2 x 17.6)	1	—
46135	Glass top S/S chafer with S/S trim and porcelain food pan	6 (5.8)	15.43 x 16.23 x 6.9 (39.2 x 41.2 x 17.6)	1	—
46136	Porcelain food pan	3.75 (3.5)	15.43 x 2.48 x 8.01 (39.2 x 6.3 x 20.3)	1	—
49136	Divided porcelain food pan	3.70 (3.5)	15.43 x 2.48 x 8.01 (39.2 x 6.3 x 20.3)	1	—
46137	S/S food pan	6.66 (6.3)	15.43 x 2.48 x 8.01 (39.2 x 6.3 x 20.3)	1	—
46112	Black chafer stand*	—	—	1	—
46113	S/S stand*	—	—	1	—

*Stand requires a fuel cup or electric chafer heater – order separately

TRADITIONAL CHAFERS

Somerville® Chafers

A VOLLRATH PREMIER CHAFER LINE FOR THE MOST DISCRIMINATING BUFFETS. THE PATENTED INSPIRATIONAL DESIGN, STUNNING FINISH, AND UNIQUE ACCENT FEATURES CONVEY AN UPSCALE IMAGE IN ANY DECOR.

- Elegant mirror-finished, heavy-duty stainless steel
- Durable, solid legs and welded construction
- Chafers feature a new heavy-duty hinge design that works in the closed, 90°, and fully open position
- Included windguard shields fuel from wind for outdoor use and for more attractive presentations
- Use standard fuel or Vollrath's Electric Chafer Heater (sold separately; see page 211)
- A full offering of matching buffet components also available



4634110



4635610



4634010

ITEM #	DESCRIPTION	CAPACITY	DIMENSIONS (L X W X H): IN (CM)	CASE LOT
4634010	Rectangular chafer, fully retractable, with Super Pan V® dripless water pan, 3-position dome cover	9 qt (8.6 L)	26¼ x 18¾ x 18¾ (66.7 x 47.9 x 47.6)	1
4635610	Round chafer, fully retractable, with dripless water pan, 3-position dome cover	6 qt (5.7 L)	19¾ x 20 x 19¾ (50.6 x 50.8 x 50.6)	1
4634110	Round drop-in chafer	6 qt (5.7 L)	21 x 21 x 15¾ (53 x 53 x 40)	1
4635710	Soup urn	7 qt (6.6 L)	13 x 11 x 23½ (33 x 27.9 x 59.7)	1
4635410	Gravy/sauce urn	4 qt (4.4 L)	13 x 11 x 19¾ (33 x 27.9 x 50.2)	1
4635310	Coffee urn	3 gal (11.4 L)	13 x 13½ x 22 (33 x 34 x 56)	1
4635510	Coffee urn	5 gal (18.9 L)	13 x 13½ x 27¾ (33 x 34 x 70)	1
4635110	Milk dispenser	5 qt (4.8 L)	8 x 12¾ x 16¾ (20 x 33 x 42)	1
4635810	Juice/cold beverage dispenser	8 qt (7.6 L)	12¾ x 8 x 22¾ (33 x 20 x 57)	1
4635210	Double cereal dispenser, each	4 qt (3.8 L)	12 x 8¾ x 23¾ (31 x 22 x 60)	1



Channeled Cover



Dripless Water Pan



Breakthrough Hinge Design



Removable Cover



Windguard

Somerville® Accessories



4635710



4635410



4635310



4635510



4635110



4635810



4635510

ITEM #	DESCRIPTION	FOOD PAN	WATER PAN	FUEL HOLDER	DOME COVER	TOTE BOX
4634010	Chafer	30022	4625910	46864	4634020-1	52647
4635610	Chafer	46862	46269	46864	—	—
4634110	Chafer	46862	46269	46864	—	—
4635710	Soup urn	4635730-1*	—	46864	4635720-1	52645
4635410	Gravy/sauce urn	4635430-1*	—	46864	4635420-1	52645
4635310	Coffee urn	—	—	46864	—	52647
4635510	Coffee urn	—	—	46864	—	52647
4635110	Milk dispenser	—	—	—	—	—
4635810	Juice/cold beverage dispenser	—	—	—	—	52645
4635210	Double cereal dispenser	—	—	—	—	52645

*Accessory inset item number is listed.



New York, New York® Chafers

WHEN NOTHING BUT THE MOST ELEGANT DINING EXPERIENCE WILL DO, CHOOSE THE LINE THAT SETS THE STANDARD – NEW YORK, NEW YORK®. A FAVORITE OF HOTELS, RESTAURANTS, AND CATERERS WHO DESIRE QUALITY, ELEGANCE, AND VALUE.

RETRACTABLE CHAFERS

- Mirror-finished, 18-8 stainless steel
- Durable, solid legs and welded construction
- Chafers feature channeled cover that transfers condensation into the water pan
- Includes windguards



46255



46258



46265



46268



46080



46070

STANDARD CHAFERS

- Chafer dome cover opens to 90° and includes a standard water pan

DROP-IN CHAFERS

- Drop-in chafer cover hinge design enables three cover positions – closed, 90°, and fully open
- Removable cover for easy cleaning

ITEM #	SILVERPLATE ITEM #	DESCRIPTION	CAPACITY	DIMENSIONS L X W X H: IN (CM)	CASE LOT	FOOD PAN	TOTE BOX
46255	48755	Countertop rectangular chafer, fully retractable with SuperPan V® food pan, dripless water pan, 3-position dome cover, and windguard shield	9 qt (8.6 L)	25 x 17½ x 18½ (63.5 x 44.45 x 47)	1	30022	52647
46265	48765	Countertop round chafer, fully retractable with food pan, dripless water pan, 3-position dome cover, and windguard shield	6 qt (5.7 L)	19 x 19 x 18½ (48.26 x 48.26 x 47)	1	46862	52647
46258	48758	Drop-in rectangular chafer, fully retractable with SuperPan V® food pan, dripless water pan, 3-position dome cover	9 qt (8.6 L)	25¾ x 18¼ x 17½ (65.4 x 46.4 x 44.5)	1	30022	—
46268	48768	Drop-in round chafer, fully retractable with food pan, dripless water pan, 3-position dome cover	6 qt (5.7 L)	19¼ x 19¼ x 19 (50.0 x 50.0 x 48.3)	1	46862	—
46093	48793	Coffee urn	3 gal/77 cups/11.4 L	12¾ x 13 x 19¾ (32.4 x 33.0 x 50.2)	1	—	52647
46094	48794	Coffee urn	5 gal/128 cups/18.9 L	15½ x 16½ x 21¾ (39.4 x 41.9 x 55.2)	1	—	52647
46090	48790	Soup chafer	7 qt (6.6 L)	12¾ x 10¼ x 19¾ (32.4 x 26.0 x 50.2)	1	46088	52648
46095	48795	Gravy/sauce chafer	2½ qt (2.4 L)	12¾ x 10¼ x 15 (32.4 x 26.0 x 38.1)	1	46104	52648
46280	—	Beverage dispenser brass accents	2 gal/51 cups/7.6 L	21 x 8 dia/11** (53.3 x 20.3 dia/27.9)	1	—	52645
46285	—	Beverage dispenser chrome accents	2 gal/51 cups/7.6 L	21 x 8 dia/11** (53.3 x 20.3 dia/27.9)	1	—	52645
46072	48772	Punch bowl	4 gal (15.1 L)	17 x 11 (43.2 x 27.9)	1	—	—
46080*	48780*	Countertop rectangular chafer, with standard water pan, dome cover only opens to 90°	9 qt (8.6 L)	25½ x 18½ x 18½ (64.8 x 47 x 47)	1	30022	52647
46070*	48770*	Countertop round chafer, with standard water pan, dome cover only opens to 90°	6 qt (5.7 L)	18½ x 18 x 18¾ (47 x 45.7 x 47.6)	1	46862	52647

*Standard product does not include windguard or dripless water pan **Dimensions at faucet



Channeled Cover



Dripless Water Pan



Breakthrough Hinge Design



Removable Cover

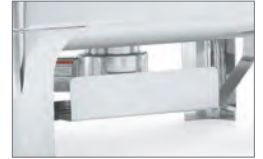

Windguard



ELECTRIC CHAFER HEATER

Operates without open flame for safety. Sold separately. See page 214 for more information.



46093



46095



46090



46280



46285



46072

New York, New York[®] Accessories

CHAFFER ITEM #	FOOD PAN	WATER PAN	FUEL HOLDER	DOMES COVER	TOTE BOX
46255	30022	46259	46864	46261, 46263	52647
46080	30022	46082	46864	46084	52647
46265	46862	46269	46864	46262, 46276	52647
46070	46862	46073	46864	—	52647
46090	46088*	—	46864	46089	52648
46093	—	—	46864	46089	52647
46094	—	—	46864	46087	52647
46095	46104*	—	46864	46089	52648
46258	30022	4652910			
46268	46862	46269			

*Inset

New York, New York[®] Cold Beverage Dispenser Replacement Parts*

BRASS ITEM #	CHROME ITEM #	DESCRIPTION	CASE LOT
46271	46271	Base, mirror-finished stainless steel	1
46830	46830	Replacement polycarbonate container	1
46272	46283	Cover and knob, mirror-finished stainless steel	1
46273	46284	Knob only – for cover	1
46274	46287	Spigot with handle	1
46275	46288	Handle only – for spigot	1
46831	46831	Ice tube, mirror-finished stainless steel	1

*For 2-Gallon Beverage Dispensers (items 46280 and 46285)

Orion® Chafers

RETRACTABLE CHAFERS

- Full three-position operation
- Perforated cover helps reduce condensation
- Windguard for outdoor use
- Removable cover for easy cleaning
- Orion® chafers include food pan, water pan, and fuel holder(s)



ELECTRIC CHAFER

- Ships with a full-size electric water pan, rated 120V, 450W
- Automatically regulates to maintain water temperature at approximately 180°-200°F (82.2°-93.3°C) – does not require an adjustable thermostat
- 6-foot cord and plug



LIFT-OFF CHAFERS

- Feature mirror-finished dripless pans
- Complete with built-in cover holder designed for convenient storage
- Includes cover holder, water pan, food pan, dome cover, and fuel holder(s)



ITEM #	DESCRIPTION	CAPACITY: QT (L)	DIMENSIONS (L X W X H): IN (CM)	CASE LOT	FOOD PAN	TOTE BOX
ORION® RETRACTABLE CHAFERS						
46520	Full-size rectangular	9 (8.6)	17 x 25 x 16 (43.2 x 63.5 x 40.6)	1	30022	52647
46530	Round retractable	6 (5.7)	18½ x 18 (47 x 46)	1	46862	52647
ELECTRIC CHAFER						
46529	Full-size rectangular w/electric heater	9 (8.6)	17 x 25 x 16 (43.2 x 63.5 x 40.6)	1	30022	52647
ORION® LIFT-OFF CHAFERS						
46518	Full-size oblong chafers – complete	9 (8.6)	27 x 14 x 13½ (67.5 x 35 x 33.8)	1	30022	52647
46500	Large oval chafers	6 (5.7)	21¼ x 17½ x 13¾ (55.2 x 44.5 x 34)	1	46504	52645
46501	Small oval chafers	4 (3.8)	18½ x 15¼ x 12¼ (47.0 x 38.7 x 32.2)	1	46505	52645
46502	Large round chafers	6 (5.7)	19 x 19¼ x 13½ (48.3 x 48.9 x 34.3)	1	46506	52646
46503	Small round chafers	4 (3.8)	15½ x 15½ x 12½ (39.4 x 39.4 x 31.9)	1	46507	52646



D-Lux Chafers

D-LUX CHAFERS

- Mirror-finished durable stainless steel
- Dripless roll-top covers lift off for easy cleaning



T3600



T3633



T3605



T3660

D-LUX SOUP CHAFER

- Round Soup Chafer works on induction ranges or included stand with canned fuel
- Damped-hinged self-closing lid
- Ladle side tray included

D-LUX CEREAL DISPENSER

- Cereal dispenser with single transparent acrylic body
- Removable cover for easy filling from top

ITEM #	DESCRIPTION	CAPACITY: QT (L)	DIMENSIONS (L X W X H): IN (CM)	CASE LOT	FOOD PAN	TOTE BOX
T3600*	D-Lux full chafers	8.5 (8)	25 x 21 x 18 (63.5 x 53.3 x 45.7)	1	30022	-
T3605*	D-Lux round chafers	6 (5.7)	19 x 22 x 19 (48.3 x 55.9 x 48.3)	1	T3505FP	-
T3633*	D-Lux soup chafers, induction	11 (10.4)	22 x 20 x 17 (55.9 x 50.8 x 43.2)	1	25940-1**	52647
T3660*	D-Lux cereal dispenser	8.5 (8)	10 x 14 x 27 (25.4 x 35.6 x 68.6)	1	**	52646

*D-Lux Chafers are not compatible w/ the 46060 Chafer Heater

**Inset



Maximillian Steel™ Buffet Service

- Mirror-finished stainless steel
- 49520 features a cover holder



49520 Showing cover holder 46477-1



ITEM #	DESCRIPTION	CAPACITY: QT (L)	DIMENSIONS (L X W X H): IN (CM)	CASE LOT	FOOD PAN	TOTE BOX
49520	Full-size rectangular chafer	9 qt (8.6 L)	23½ x 17 x 12½ (59.69 x 43.18 x 31.75)	1	30022	52647
49529	Half-size rectangular chafer	4.1 qt (3.8 L)	15 ² / ₃₂ x 11 ⁵ / ₈ x 12 ³ / ₁₆ (40.24 x 29.53 x 31)	1	30222	52647
49521	Medium round chafer	4.2 qt (4 L)	15 dia x 11½ (38.1 x 38.1 x 29.21)	1	49333	52645
49522	Large round chafer	6 qt (5.8 L)	18 dia x 13 (45.7 x 33)	1	46862	52647
49523	Marmite	4.2 qt (4 L)	11 dia x 16 (27.9 dia x 40.6)	1	46458-1**	52645
49524	Marmite	7.4 qt (7 L)	11 dia x 16 (27.9 dia x 40.6)	1	46447-1**	52647
49525*	Coffee urn	11.6 qt (11 L)	13 x 13½ x 19 (33.02 x 34.29 x 48.26)	1	—	52647

*Does not work with electric chafer heater

**Inset

Panacea™ Buffet Service

- Mirror-finished stainless steel
- 24k gold accents add elegance and style
- 48322 features a cover holder



48322 Showing cover holder 46476-1



48327



48328



48322



48329



48323

ITEM #	DESCRIPTION	CAPACITY: QT (L)	DIMENSIONS (L X W X H): IN (CM)	CASE LOT	FOOD PAN	TOTE BOX
48322	Full-size rectangular chafer	9 (8.6)	24 x 17 x 13½ (60.96 x 43.18 x 34.29)	1	30022	52647
48329	Half-size rectangular chafer	4.1 (3.8)	16½ x 11½ x 12¾ (42.2 x 29.5 x 32.4)	1	30222	52645
48323*	Medium round chafer	4.2 (4)	15½ x 13½ x 11 (39.5 x 34.5 x 27.9)	1	49333	52645
48324*	Large round chafer	6 (5.8)	17 x 15 x 12 (43.2 x 38.1 x 30.5)	1	46862	52647
48326	Marmite	4.2 (4)	11½ dia x 15½ (29.2 dia x 39.4)	1	46458-1***	52645
48327	Marmite	7.4 (7)	11½ dia x 15½ (29.2 dia x 39.4)	1	46447-1***	52647
48328**	Coffee urn	11.6 (11)	13½ x 12 x 19½ (34.29 x 30.48 x 49.53)	1	—	52647

*Round chafers include round food pan and round water pan

**Does not work with electric chafer heater

***Inset



OPTIONAL DIVIDED FOOD PAN

49334 for 4.2 qt

46861 for 6 qt

Classic Brass Trim Buffet Service

- Mirror-finished 18-8 stainless steel
- Solid cast brass legs and handles



*UL listed applies to electric chafers only

ROLL-TOP CHAFER (46051)

- Add the elegance of a roll-top cover to this classic brass chafer
- Smooth-rolling cover opens a full 90° to allow easy access
- Cover (46052) fits most full-size chafers that use standard dripless water pan securely without clips or brackets and lifts off for quick food replenishment

COFFEE URN (46029)

- Removable faucet for easy cleaning

SOUP MARMITE (46075)

- Includes separate inset, water pan, cover, and fuel holder
- Notched cover allows serving utensil to remain in vessel for maximum sanitation

ELECTRIC CHAFERS* (46040, 46045)

- Fully adjustable non-thermostatic heat control
- Six-foot grounded plug
- 120V, 700W, 6 Amp, AC only
- Water pan is welded to unitized frame
- Frame and control are non-immersible
- Option to use with fuel or electric



ITEM #	DESCRIPTION	CAPACITY	DIMENSIONS (L X W X H): IN (CM)	CASE LOT	FOOD PAN	TOTE BOX
46050*	Full-size chafers	9 qt (8.6 L)	25¼ x 14½ x 15 (64.1 x 36.8 x 38.1)	1	30022	52645
46035*	One-half size chafers	4.1 qt (3.8 L)	16¾ x 11½ x 14¼ (42.5 x 29.2 x 36.8)	1	30222	52645
46030*	Round chafers	5.8 qt (5.5 L)	18½ x 15¼ x 14¼ (47.0 x 38.7 x 36.2)	1	46862/46861**	52645
46051*	Roll-top chafers – complete	9 qt (8.6 L)	25¼ x 15½ x 19¾ (64.1 x 36.8 x 50.2)	1	30022	52647
46052	Roll-top cover only	—	21⅞ x 14⅞ x 9⅞ (53.7 x 37.8 x 24.5)	1	—	52645
46029	Coffee urn	3 gal/77 cups/11.4 L	12¾ x 12 x 21¾ (32.4 x 30.5 x 55.2)	1	—	52648
46075	Marmite	7¼ qt (6.9 L)	11¾ x 10¼ x 13¼ (29.8 x 26.0 x 33.7)	1	46063-2**	52647
46040	Long-side receptacle electric chafers	—	25¼ x 18¼ x 15 (64.1 x 46.4 x 38.1)	1	30022	52647
46045	Short-side receptacle electric chafers	—	21¼ x 14½ x 15 (69.2 x 36.8 x 38.1)	1	30022	52647

*46030 Chafers is not compatible w/ the 46060 chafers heater
 ** Inset

Value Series Roll-Top Chafers

- Three-position roll-top lid – closed, 90°, and 180°
- Mirror-finished stainless steel with welded frame
- Includes lid, frame, water pan, food pan, and two fuel holders



ITEM #	DESCRIPTION	CAPACITY QT (L)	DIMENSIONS L X W X H: IN (CM)	CASE LOT	WATER PAN	FOOD PAN	DIVIDED ROUND FOOD PAN	TOTE BOX
T3500*	Value Series 180° roll-top chafers	8 (7.6)	26 x 20 x 17 (66.0 x 50.8 x 43.2)	1	25562-1	30022	—	52647
T3505*	Value Series 180° round roll-top chafers	6 (5.6)	19 x 22 (48.3 x 55.9)	1	T3505WP	T3505FP	T3515DFP	52647

*Value Series roll-top chafers are not compatible with the Electric Chafers Heater

Dakota™ Chafers

- Stainless steel matte-finished embossed legs for strength and style
- Includes Super Pan V® food pan, water pan, dome cover, frame, and fuel holder
- Stacking frame takes up less space when not in use
- Kool-Touch® molded high-temperature nylon handles on frame for easy transport



ITEM #	DESCRIPTION	CAPACITY QT (L)	DIMENSIONS L X W X H: IN (CM)	CASE LOT	FOOD PAN	WATER PAN	FUEL HOLDER	COVER	TOTE BOX
99860	Rectangular – complete	9 (8.6)	25 ⁵ / ₁₆ x 14 ³ / ₁₆ x 13 ³ / ₁₆ (65.1 x 36.3 x 34.5)	1	30022	99745	46864	99873	52647
99870	Half-size – complete	4.1 (3.8)	18 ¹ / ₁₆ x 12 ¹ / ₁₆ x 13 ¹ / ₃₂ (45.9 x 30.6 x 33.6)	1	30222	46858	46864	99869	52648
46886	Full-size stackable chafers rack	—	25 ⁵ / ₁₆ x 14 ³ / ₁₆ x 9 ¹ / ₄ (65.1 x 36.3 x 23.5)	4	—	—	—	—	52648

Trimline II Chafers

- Sturdy welded frame is stackable for compact storage
- Dome cover with Kool-Touch® handle
- 12 standard racks are 21" (53.3 cm) high – stacked
- Holds standard or dripless water pan



ITEM #	DESCRIPTION	CAPACITY: QT (L)	DIMENSIONS (L X W X H): IN (CM)	CASE LOT	FOOD PAN	TOTE BOX
99850	Trimline II Chafers – complete	9 (8.6)	23 ³ / ₄ x 14 ¹ / ₄ x 14 ¹ / ₄ (59.1 x 36.2 x 36.2)	1	30022	52645
77200	Dome cover	—	—	1	—	—
46885	Stackable chafers rack	—	23 ³ / ₄ x 13 ¹ / ₄ x 10 ¹ / ₄ (60.6 x 33.7 x 26.0)	3	—	—
46864	Fuel holder	—	—	1	—	—

Avenger™ Economy Roll-Top Chafers

- Mirror-finished 18-8 stainless steel construction – durable and easy to clean
- Fully retractable perforated cover – works in closed, 90°, and fully open position for serving flexibility
- Windguard shields fuel from wind for outdoor use and for more attractive presentations



ITEM #	DESCRIPTION	CAPACITY QT (L)	DIMENSIONS L X W X H: IN (CM)	CASE LOT	WATER PAN	FOOD PAN	TOTE BOX
46350	Rectangular chafers includes Super Pan V® food pan, water pan, and domed cover	9 (8.6)	17 x 25 x 16 (43.2 x 63.5 x 40.6)	1	46082	30022	52647
46360	Round chafers includes round food pan, water pan, and domed cover	6 (5.7)	18 ¹ / ₂ x 18 (47 x 45.7)	1	46073	46862	52647

*Avenger chafers are not compatible with the Electric Chafers Heater

CHAFER ACCESSORIES



Electric Chafers Heater

- Designed to maintain the proper serving temperature without the need for open flame
- Sized to fit most standard fuel cup openings
- Spring-loaded element maintains full contact with the water pan for efficient heat transfer
- Lighted switch glows when heater is turned on (US model)
- Choose from two power settings – use low setting for all coffee urns
- 6-ft. grounded cord
- Only one chafers heater needed per full-size chafers if set on “high” and water level does not exceed 1/3” (0.8 cm)

ITEM #	DESCRIPTION	VOLTAGE	WATTS	AMPS	PLUG	CASE LOT
46060*	Electric chafers heater (Domestic**)	120	120/230	2.3	NEMA 5-15P	1
INTERNATIONAL MODELS – AVAILABLE FOR EXPORT ONLY						
46110*	Electric chafers heater (Europe***)	230	120/230	1.0	SCHUKO	1
46115*	Electric chafers heater (UK****)	230	120/230	1.0	UK	1

Domestic models *International Models – for export only

ITEM #	PRODUCT LINE	DESCRIPTION	CAPACITY
NOT COMPATIBLE WITH THE FOLLOWING CHAFERS			
46030	Classic Brass Trim Buffet Service	Classic brass-trim buffet service round chafers	5.8 qt
46350	Avenger Economy Roll-Top	Avenger economy roll-top chafers, rectangular	9.0 qt
46360	Avenger Economy Roll-Top	Avenger economy roll-top chafers, round	6.0 qt
48328	Panacea Chafers	Panacea coffee urn	11.6 qt
49525	Maximillian Chafers	Maximillian steel chafers coffee urn	11.6 qt
T3500	Value Series Economy	Full-size roll-top chafers, rectangle	8.0 qt
T3505	Value Series Economy Roll-Top	Round roll-top chafers	7.0 qt
T3600	D-Lux Chafers	Full-size roll-top chafers, rectangle	8.5 qt
T3605	D-Lux Chafers	Round roll-top chafers	6 qt
T3633	D-Lux Chafers	Round soup chafers	11 qt



Water Pans

- 300 series stainless steel
- Dripless style (with lip) prevents condensation from dripping onto table
- 19^{27/32}" x 11^{7/8}" x 4^{3/8}" (50 x 30 x 11 cm)



ITEM #	DESCRIPTION	OVERALL DIMENSIONS: IN (CM)	CASE LOT
99745	Dripless water pan	22 ^{1/8} x 14 ^{3/32} x 4 ^{3/8} (56 x 36 x 11)	2
99740	Standard water pan	20 ^{23/32} x 12 ^{3/4} x 4 ^{3/8} (52.5 x 32.5 x 11)	2

Divided Food Pans

- Heavy-duty 18-8 stainless steel

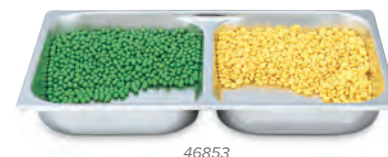

ITEM #	DESCRIPTION	CAPACITY PER SIDE: QT (L)	DIMENSIONS: IN (CM)	FITS	CASE LOT
46861	Round divided food pan	4 qts/ 2 qts per side	15 ^{1/2} dia x 2 ^{1/8} h (38.4 dia x 6.2 h)	46030, 46070, 46265, 46268, 46293, 46298, 46860, 46360	1
49334	Round divided food pan	1.2 (1.2)	13 ^{3/8} dia. x 2 ^{1/8} h (34.0 dia. x 5.4 h)	48323, 49521	1
46853	Full-size divided food pan	3.4 (3.3)	20 ^{3/4} x 12 ^{3/4} x 2 ^{1/2} (53 x 32.5 x 6.4)	All full-size chafers	6

PanaMax™ Dome Cover



- Patented low-profile design fits any full-size chafer or well
- Durable ergonomic nylon handle offers comfortable grip – heat resistant to 475°F (246°C)
- Mirror-finished stainless steel looks great and is easy to clean and maintain

ITEM #	DESCRIPTION	DIMENSIONS (L X W X H): IN (CM)	CASE LOT
49339	Full-size	21 x 13 x 4½ (53.3 x 33 x 11.4)	1

Soup Accessory Kit



- Increase the flexibility of chafers with these accessories
- Kit does not include chafer frame, water pan, or fuel cups

ITEM #	DESCRIPTION	CASE LOT
99880	Double soup buffet accessory kit includes full-size adaptor plate (19192), two adaptor rings (19194), two 7¼ qt (6.9 L) vegetable insets (78184), two hinged covers (47488), two 4 oz (118.0 ml) Kool Touch® ladles (58044)	1

Stackable Wire Rack



- Stackable for compact storage
- Heavy-duty chrome-plated steel rack holds up to 3 fuel holders
- ¼" (.6 mm) wire diameter
- Holds one dripless water pan



ITEM #	DESCRIPTION	CASE LOT
46872*	Wire stand only	3

*Not designed for use with aluminum foil water pans

Fuel Holder with Cover



- 18-8 stainless steel
- Fits all chafer stands

ITEM #	DESCRIPTION	DIMENSIONS (DIA X H): IN (CM)	HANDLE IN (CM)	CASE LOT
46864	Fuel holder w/cover*	3¾ x 2⅞ (9.1 x 6.2)	2⅞ (6.8)	12

*Cover cannot be ordered separately

Tote 'N Store™ Chafer Boxes

- Heavy-duty impact-resistant plastic construction with integral handles
- Nestable and stackable
- Permanently affixed hinged lids open and close easily
- Integral holes allow totes to be padlocked

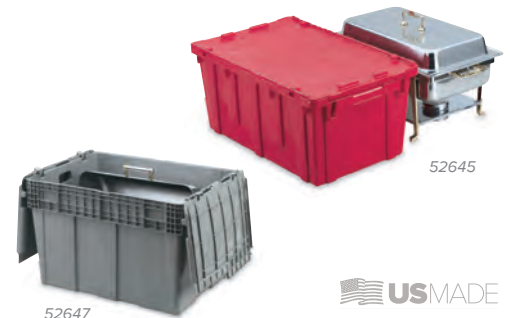

ITEM #	COLOR	FITS ITEM #	INSIDE TOP DIMENSIONS (L X W X H): IN (CM)	INSIDE BOTTOM DIMENSIONS (L X W): IN (CM)	CASE LOT
52648	Blue	46029, 46075, 46095, 46884, 48795, 99870, 46090	20⅞ x 11⅞ x 12⅞ (51.1 x 28.9 x 31.4)	18⅞ x 10⅞ (47.9 x 25.7)	3
52645	Red	46030, 46035, 46050, 46052, 46120, 46121, 46122, 46123, 46280, 46321, 46322, 46500, 46501, 46847, 48323, 48326, 48329, 48790, 49322, 49323, 49329, 49521, 49523, 99850, 4635710, 4635410	25⅞ x 15½ x 11⅞ (63.8 x 39.4 x 29.5)	23⅞ x 13⅞ (60.0 x 35.2)	3
52647	Grey	46040, 46045, 46051, 46070, 46075, 46080, 46093, 46094, 46255, 46265, 46350, 46360, 46518, 46520, 46530, 46860, 48322, 48324, 48327, 48328, 46880, 48780, 48770, 48793, 48794, 49520, 49522, 49524, 49525, 49529, 99860, 4634010, 4635610, T3500, T3505, T3633	28¾ x 20¾ x 18¾ (73.0 x 52.7 x 47.6)	26⅞ x 18⅞ (67.6 x 47.3)	1
52646*	Grey	46094, 46502, 46503, T3660	21¾ x 20⅞ x 13 (55.2 x 53.0 x 33.0)	21⅞ x 20½ (54.5 x 52.1)	1

*Includes removable lid and foam base

Buffetware Box

- Ideal for transporting hollow-handle buffetware and table service accessories
- Grey



52649

ITEM #	DESCRIPTION	INSIDE TOP DIMENSIONS (L X W X H): IN (CM)	INSIDE BOTTOM DIMENSIONS (L X W): IN (CM)	CASE LOT
52649	Buffetware box	20 $\frac{1}{2}$ x 14 $\frac{1}{4}$ x 4 $\frac{5}{8}$ (51.1 x 36.2 x 11.8)	18 $\frac{3}{4}$ x 13 $\frac{3}{4}$ (47.6 x 33.7)	3

Buffet Storage Racks

- Ideal for storing and transporting induction buffet warmers and induction chafers and stands
- Beige



CR2AAAA32



CR232 with TR33

ITEM #	COLOR	FOR STORING ITEMS:	DIMENSIONS (L X W): IN (CM)	CASE LOT
CR232	Beige	16" x 16" Induction Buffet Warmer	19 $\frac{3}{4}$ X 19 $\frac{3}{4}$ x 4 (50 X 50 x 10.2)	1
CR2AAAA32	Beige	Round or Square Induction Chafer	19 $\frac{3}{4}$ X 19 $\frac{3}{4}$ x 10 $\frac{5}{16}$ (50 X 50 x 26.2)	1
CR2AAAAAA32	Beige	16" x 16" Induction Buffet Warmer with Round or Square Induction Chafer	19 $\frac{3}{4}$ X 19 $\frac{3}{4}$ x 13 (50 X 50 x 33)	1
CR2AAAAAAA32	Beige	Square or Round Chafer Stand with Round or Square Induction Chafer	19 $\frac{3}{4}$ X 19 $\frac{3}{4}$ x 15 $\frac{1}{8}$ (50 X 50 x 38.4)	1
TR33	Beige	Rack Storage Cover	19 $\frac{3}{4}$ X 19 $\frac{3}{4}$ x 1 $\frac{1}{16}$ (50 X 50 x 3.7)	1

*Extenders available in other colors; contact Vollrath.

BUFFETWARE

Miramar® Contemporary Serving Utensils

- Aesthetically pleasing appearance is ideal for front-of-house use
- Ergonomic design makes utensils comfortable to use
- Capacity is clearly marked on back in oz, ml, and cups to help ensure consistent, correct portion sizes
- Handles constructed of durable, heavy-duty cast stainless steel
- Dishwasher safe
- Easy to clean



ITEM #	DESCRIPTION	OVERALL LENGTH: IN (CM)	CASE LOT
SOLID BOWL SERVERS			
46720	1/8-cup oval servers – solid bowl	10.96 (27.8)	6
46721	1/4-cup oval servers – solid bowl	11.47 (29.1)	6
46722	1/2-cup oval servers – solid bowl	11.843 (30.1)	6
46723	1/2-cup oval servers – solid bowl	12.34 (31.3)	6
46725	3/4-cup oval servers – solid bowl	12.82 (32.6)	6
46724	1-cup oval servers – solid bowl	13.183 (33.5)	6
SLOTTED BOWL SERVERS			
46726	1/8-cup oval servers – slotted bowl	10.96 (27.8)	6
46727	1/4-cup oval servers – slotted bowl	11.47 (29.1)	6
46728	1/2-cup oval servers – slotted bowl	11.843 (30.1)	6
46729	1/2-cup oval servers – slotted bowl	12.34 (31.3)	6
46731	3/4-cup oval servers – slotted bowl	12.82 (32.6)	6
46730	1-cup oval servers – slotted bowl	13.183 (33.5)	6



ITEM #	DESCRIPTION	OVERALL LENGTH: IN (CM)	CASE LOT
UTENSILS			
46732	Bread/pastry tong – 8"	10.724 (27.2)	6
46733	Serving tong – 10"	10.974 (27.9)	6
46738	Serving ladle – 2 oz	7.928 (20.1)	6
46739	Serving ladle – 4 oz	10 (25.4)	6
46740	Pastry server	11 (27.9)	6
46741	Meat fork – 2-tine	11.5 (29.2)	6
46742	Solid serving spoon	11.42 (29)	6
46743	Slotted serving spoon	11.42 (29)	6

Windway® Hollow-Handle Buffetware

- One-piece, mirror-finished 18-8 stainless steel
- Thick handles with finger grips fit the hand comfortably
- Gold-plated swirl accent

ITEM #	DESCRIPTION	OVERALL LENGTH: IN (CM)	CASE LOT
A. 46641	Ladle 4 oz (118.3 ml)	12 $\frac{3}{8}$ (32)	12
B. 46642	Perforated turner	14 $\frac{3}{8}$ (37.1)	12
C. 46647	Solid serving spoon	12 $\frac{1}{4}$ (31.2)	12
D. 46646	Notched serving spoon	12 $\frac{1}{4}$ (31.2)	12
E. 46650	Slotted serving spoon	12 $\frac{1}{4}$ (31.2)	12
F. 46645	Buffet tong	11 $\frac{1}{8}$ (30.2)	6
G. 46644	Pastry server	11 $\frac{1}{2}$ (29.2)	12



Hollow-Handle Buffetware

- One-piece, mirror-finished stainless steel
- Comfortable handles with finger grips
- Well-balanced design



ITEM #	DESCRIPTION	OVERALL LENGTH: IN (CM)	CASE LOT
46905	Ladle with spout 1 oz (29.6 ml)	11 $\frac{1}{8}$ (29.4)	12
46907	Ladle with spout 2 oz (59.1 ml)	12 $\frac{3}{8}$ (31.9)	12
46909	Ladle 4 oz (118.3 ml)	12 $\frac{3}{8}$ (31.9)	12
46930	Perforated turner	14 $\frac{3}{8}$ (36.0)	12
46935	Pie server	11 $\frac{1}{8}$ (28.4)	12
46936	Pastry server	11 (27.9)	12
46937	Cheese plane	11 (27.9)	12

ITEM #	DESCRIPTION	OVERALL LENGTH: IN (CM)	CASE LOT
46952	Solid serving spoon	11 $\frac{1}{8}$ (29.5)	12
46960	Slotted serving spoon	12 (30.5)	12
46950	Notched serving spoon	11 $\frac{1}{8}$ (29.5)	12
46956	Cold meat fork 4-tine	10 $\frac{3}{8}$ (26.4)	12
46955	Pot fork 2-tine	11 $\frac{1}{8}$ (28.4)	12
48145	Slicing knife with 9" (22.9 cm) blade	13 $\frac{3}{4}$ (34.9)	12
48146	Carving knife with 8" (20.3 cm) blade	12 $\frac{3}{4}$ (32.4)	12

Kool-Touch® Buffetware

- Attractive black Kool-Touch® handle insulates to provide a cool grip
- Heat resistant to 350°F (177°C)
- 18-8 stainless steel with hollow handles



ITEM #	DESCRIPTION	OVERALL LENGTH: IN (CM)	CASE LOT
46916	Ladle 4 oz (118.3 ml)	12 ³ / ₈ (31.9)	12
46918	Pot fork 2-tine	11 ³ / ₈ (28.4)	12
46919	Slotted serving spoon	12 (30.5)	12
46917	Solid serving spoon	11 ³ / ₈ (29.5)	12
46920	Notched serving spoon	11 ³ / ₈ (29.5)	12

Stainless Steel Buffet Serving Tongs

- One-piece, mirror-finished stainless steel
- Stylishly designed for durability and function



ITEM #	SILVERPLATE ITEM #	DESCRIPTION	OVERALL LENGTH: IN (CM)	CASE LOT
46929	48429	Pastry tongs	8 (20)	24
46928	48428	Bread tongs	9 ¹ / ₄ (23.5)	12
46927	48427	Scalloped serving tongs	10 (25)	12
46926	48426	Serving tongs	8 ³ / ₄ (21)	12
46925*	48425*	Scissor salad tongs	10 (25)	10
46988	—	Spaghetti tongs	9 (22.9)	12
46989	—	Spaghetti tongs	11 ¹ / ₂ (29.2)	12
46938	—	Buffet tongs	12 (30.5)	6
46645	—	Buffet tongs	11 ³ / ₈ (30.2)	6

*Two-piece construction

Stainless Steel Serving Utensils

- Elegant embossed pattern



ITEM #	DESCRIPTION	OVERALL LENGTH: IN (CM)	CASE LOT
46942	Ladle 2 oz (59.1 ml)	9 (22.9)	12
46944	Ladle 4 oz (118.3 ml)	12 (30.5)	12
46954	Fork	13 (33)	12
46951	Spoon	11 ¹ / ₂ (29.2)	12
46953	Spoon	13 (33)	12

Stainless Steel Serving Ladles

ITEM #	CAPACITY: OZ (MIL)	OVERALL LENGTH: IN (CM)	CASE LOT
46940	¹ / ₂ (14.8)	6 (15.2)	12
46941	1 (29.6)	6 ⁵ / ₈ (16.8)	12
47892	6 (177.4)	12 (30.5)	24



BREATH GUARDS



MB98720 Back-to-back arrangement

Mobile Breath Guards

- Adjustable height 14¼" to 25¼" (36.2 cm to 64.1 cm) and angle works with most countertop serving pieces, chafers, and warmers
- Rugged steel base with powder coating
- Curved acrylic glass is durable and contemporary
- 4 sizes 2', 3', 4', and 5' (60.96 cm, 91.4 cm, 121.9 cm, and 152.4 cm) fit standard banquet tables; works as single or back-to-back
- Shipped knocked down – easy to assemble



For more detailed Mobile Breath Guard dimensions, go to VOLLRATH.com/mbreathguards.



MB98720



ITEM #	DESCRIPTION	LENGTH: IN (CM)	CASE LOT
MB98719	Chrome/black	24 (60.96)	1
MB98720	Chrome/black	36 (91.4)	1
MB98721	Chrome/black	48 (121.9)	1
MB98722	Chrome/black	60 (152.4)	1

Mobile Acrylic Breath Guards

- Convenient, durable, and portable solution to cover food serving areas
- Folds down flat and secures with magnetic latches for ease in transporting
- ¾" (1 cm) thick acrylic panels can be securely fastened in place with easy thumb turns



Visit VOLLRATH.com/foldingbg to view a quick demo by Chef Rich.



ITEM #	DESCRIPTION	DIMENSIONS (L X W X H): IN (CM)	CASE LOT	ITEM #
MBA92819	24" (61 cm) acrylic guard w/ bag	24 x 19½ x 16 (61 x 49.5 x 40.6)	1	2622410
MBA92820	36" (91.4 cm) acrylic guard w/ bag	36 x 19½ x 16 (91 x 49.5 x 40.6)	1	2623610
MBA92821	48" (121.9 cm) acrylic guard w/ bag	48 x 19½ x 16 (122 x 49.5 x 40.6)	1	2624810

SERVING TRAYS

Stainless Steel Serving Trays

- Heavy-gauge stainless steel is highly resistant to corrosion, pitting, and rusting
- Satin-finished rim and mirror-finished interior create a visual contrast that accentuates the food product
- Integral handles for safer carrying and comfort
- Dishwasher safe



Rectangular Trays

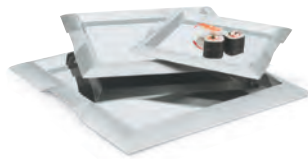

Square Trays



Round Trays



Oval Trays

ITEM #	DESCRIPTION	DIMENSIONS (L X W OR DIA): IN (CM)	CASE LOT
82093	Small rectangular tray	12 x 9 (30.5 x 22.9)	3
82094	Medium rectangular tray	18 x 10 (45.7 x 25.4)	3
82095	Large rectangular tray	21 x 12 (53.3 x 30.5)	3
82090	Small square tray	11¼ x 11¼ (29.8 x 29.8)	3
82091	Medium square tray	15¾ x 15¾ (40 x 40)	3
82092	Large square tray	18½ x 18½ (47 x 47)	3
82096	Small round tray	12 (30.5) dia	3
82097	Medium round tray	14 (35.5) dia	3
82098	Large round tray	16 (40.6) dia	3
82060	Small oval tray	14¾ x 10¾ (37.5 x 27.6)	3
82061	Medium oval tray	17¾ x 13 (44.8 x 33.0)	3
82062	Large oval tray	21½ x 15½ (53.7 x 39.4)	3

Esquire™ Fluted Trays

- Mirror-finished heavy-duty 18-10 stainless steel
- Center embossing enhances style and minimizes noticeable wear
- Food-safe contact area so trays will not pit or discolor
- Dishwasher safe



ITEM #	DESCRIPTION	DIMENSIONS (L X W OR DIA): IN (CM)	CASE LOT
82166	Rectangular fluted tray	18¼ x 12½ (46.4 x 31.8)	3
82167	Rectangular fluted tray	21 x 14¼ (53.3 x 36.2)	3
82169	Round fluted tray	14 (35.6) dia	3
82170	Round fluted tray	16 (40.6) dia	3
82172	Oval fluted tray	17¾ x 13 (44.8 x 33.0)	3
82173	Oval fluted tray	21½ x 15½ (53.6 x 39.4)	3

Odyssey™ Serving Trays

- These value-priced trays complement casual or formal banquet applications and are ideal for catered events. Various styles to meet your serving needs.
- Tough chrome plating provides long life
- Surface safe for direct food contact
- Not dishwasher safe; hand-wash only – recommend cleaning with sponge, mild detergent, and warm water



ITEM #	DESCRIPTION	DIMENSIONS (L X W OR DIA): IN (CM)	CASE LOT
47260	24K gold trim rectangular tray	18¼ x 12 ³ / ₄ (46.3 x 31.3)	6
47266	24K gold trim rectangular tray	19½ x 14 (50 x 35.5)	6
47265	24K gold trim oval tray	18½ x 13 (46 x 33)	12
47262	Classic round tray	14 (35.7) dia	6
47261	8-sided tray	17½ x 10 (43.5 x 25.5)	6
47263	8-sided tray	20 x 13¾ (50.5 x 34.5)	6
47267	Victorian rectangular tray	21¼ x 15 (55.3 x 38)	6

Elegant Reflections™ Serving Trays

- Surface safe for direct food contact
- Dishwasher safe
- Available in silverplate



NOTE: Only trays without handles are NSF® certified



Round Trays



Oval Tray



Oblong Trays



Round Gallery Tray

ITEM #	SILVERPLATE ITEM #	DESCRIPTION	DIMENSIONS (L X W OR DIA): IN (CM)	CASE LOT
82100	82366	Round tray	12¾ (31.4) dia	1
82101	82367	Round tray	15¼ (38.7) dia	1
82102	82368	Round tray	18¾ (47.3) dia	1
82111	82370	Oval tray	21¼ x 16 (55.2 x 40.6)	1
82122	82372	Oblong tray with handles*	17½ x 13¾ (45.4 x 35.2)	1
82123	82373	Oblong tray with handles*	23½ x 18½ (59.7 x 47)	1
82120**	82380	Oblong tray without handles	17½ x 13¾ (45.4 x 35.2)	1
82121**	82371	Oblong tray without handles	23½ x 18½ (59.7 x 47)	1
82131**	82375	Round gallery tray	15¼ dia x 1½ h (38.7 dia x 3.8 h)	1

*Does not include handle dimensions **NSF® certified

Oval & Round Platters

- Mirror-finished 18-8 stainless steel
- Surface safe for direct food contact
- Dishwasher safe



Silverplate your buffet and table service – more at VOLLRATH.com.



ITEM #	DESCRIPTION	DIMENSIONS (L X W OR DIA): IN (CM)	CASE LOT
47232	Oval platter	12 x 7½ x ¾ (30.5 x 20.0 x 2.2)	6
47234	Oval platter	13¾ x 9½ x ¾ (34.9 x 23.2 x 2.2)	6
47236	Oval platter	15¾ x 10¾ x 1 (40.0 x 26.4 x 2.5)	6
47238	Oval platter	18 x 12 x 1 (45.7 x 30.5 x 2.5)	6
47242	Oval platter	21½ x 13½ x ¾ (54.6 x 34.3 x 2.2)	6
47212	Round platter	12 x ¾ (30.5 x 1.9)*	12
47214	Round platter	13¾ x ¾ (35.2 x 1.9)*	12
47216	Round platter	15¾ x ¾ (40.3 x 2.2)*	12

*Diameter x Height

Stainless Steel Plates

- Satin pewter-look stainless steel
- Dishwasher safe



ITEM #	DIMENSIONS (DIA): IN (CM)	CASE LOT
47656	6 (15.2)	12

Cater Tray

- Mirror-finished 18-8 stainless steel
- Delicate edging adds touch of elegance
- Dishwasher safe



ITEM #	DIMENSIONS: IN (CM)	CASE LOT
47251	19 x 12 $\frac{3}{8}$ x $\frac{1}{2}$ (48.3 x 31.4 x 1.3)	6

Oblong Serving and Display Trays

- Satin-finished stainless steel
- Smooth rounded corners and seamless construction
- Dishwasher safe



ITEM #	DIMENSIONS (L X W X H): IN (CM)	GAUGE	CASE LOT
80130	13 $\frac{3}{8}$ x 9 $\frac{3}{4}$ x $\frac{5}{8}$ (34.6 x 24.8 x 1.6)	22	6
80150	15 $\frac{1}{8}$ x 10 $\frac{1}{2}$ x $\frac{5}{8}$ (38.4 x 26.7 x 1.6)	22	6
80170	17 $\frac{1}{8}$ x 11 $\frac{1}{8}$ x $\frac{5}{8}$ (43.5 x 29.5 x 1.6)	22	6
80190	19 x 12 $\frac{1}{2}$ x $\frac{5}{8}$ (48.3 x 31.8 x 1.6)	22	6

Double-Wall Platters

- Double-wall construction helps keep hot foods hot and cold foods cold and will not cause condensation
- Polished stainless steel construction



ITEM #	DESCRIPTION	DIMENSIONS (L X W OR DIA): IN (CM)	CASE LOT
46221	Double-wall curved platter	7 $\frac{1}{2}$ x 7 $\frac{1}{2}$ (19 x 19)	1
46222	Double-wall curved platter	12 x 7 (30.5 x 17.8)	1
46223	Double-wall curved platter	15 x 8 $\frac{3}{4}$ (38.1 x 21)	1
46224	Double-wall large round platter	14 (35.6) dia	1



SERVING BOWLS

COLORED DOUBLE-WALL INSULATED SERVING BOWLS

- Double-wall construction provides insulation to maintain proper food temperature – hot or cold
- Stainless steel
- Durable color-finish exterior and satin-finish interior enhance buffet presentation
- Will not sweat
- Requires no preheating or chilling
- Not recommended for use in ice



BOWL COLORS

15 dazzle red	25 cobalt blue	65 passion purple	35 green apple
45 nugget yellow	50 pearl white	55 fire engine red	60 black black

Colored Double-Wall Insulated Serving Bowls – Round



ITEM #	DESCRIPTION	CAPACITY: QT (L)	DIMENSIONS (DIA X H): IN (CM)	CASE LOT
46587XX	Round colored double-wall bowl	.75 (.71)	5 ⁵ / ₁₆ x 3 (14.4 x 7.6)	6
46590XX	Round colored double-wall bowl	1.7 (1.6)	7 ¹ / ₄ x 4 (18.4 x 10.3)	6
46591XX	Round colored double-wall bowl	3.4 (3.2)	9 ¹ / ₂ x 5 (24.1 x 12.9)	6
46592XX	Round colored double-wall bowl	6.9 (6.6)	11 ³ / ₁₆ x 6 ¹ / ₂ (30 x 16.5)	3
46569XX	Round colored double-wall bowl	10.1 (9.6)	13 ³ / ₄ x 6 ⁷ / ₁₆ (35 x 17.5)	2

Colored Double-Wall Insulated Serving Bowls – Square



ITEM #	DESCRIPTION	CAPACITY: QT (L)	DIMENSIONS (DIA X H): IN (CM)	CASE LOT
47619XX	Square colored double-wall bowl	.75 (.71)	5 ¹ / ₂ x 5 ¹ / ₂ x 2 ³ / ₄ (13.9 x 13.9 x 7)	6
47632XX	Square colored double-wall bowl	1.8 (1.7)	7 ¹ / ₄ x 7 ¹ / ₄ x 3 ³ / ₁₆ (18.4 x 18.4 x 8.7)	12
47634XX	Square colored double-wall bowl	3.2 (3)	8 ¹ / ₂ x 8 ¹ / ₂ x 4 ¹ / ₄ (21.6 x 21.6 x 10.8)	6
47635XX	Square colored double-wall bowl	5.2 (4.9)	10 ³ / ₁₆ x 10 ³ / ₁₆ x 5 ¹ / ₈ (25.8 x 25.8 x 13)	4
47637XX	Square colored double-wall bowl	8.2 (7.8)	11 ¹³ / ₁₆ x 11 ¹³ / ₁₆ x 5 ¹⁵ / ₁₆ (29.9 x 29.9 x 15)	3

Visit VOLLRATH.com/bowltest



See the video of how the colored double-wall bowls hold up on the baseball field.

ADD SUFFIX TO BASE ITEM NUMBER TO INDICATE COLOR SELECTION

Metallic colors: dazzle red (15), cobalt blue (25), passion purple (65). Classic colors: green apple (35), nugget yellow (45), pearl white (50), fire engine red (55), black black (60)

DOUBLE-WALL INSULATED SERVING BOWLS

- Double-wall construction provides insulation to maintain proper food temperature – hot or cold
- Dishwasher safe
- Will not sweat
- Requires no preheating or chilling
- Mirror-finished exterior and satin-finished interior for an upscale look
- Stainless steel



Fluted Double-Wall Insulated Serving Bowls – Square and Round

ITEM #	DESCRIPTION	CAPACITY: QT (L)	DIMENSIONS (L X W X H): IN (CM)	CASE LOT
47680	Square fluted bowl	.75 (.71)	5½ x 5½ x 2¼ (13.9 x 13.9 x 7)	6
47681	Square fluted bowl	1.8 (1.7)	7¼ x 7¼ x 3⅝ (18.4 x 18.4 x 8.7)	6
47682	Square fluted bowl	3.2 (3)	8½ x 8½ x 4¼ (21.6 x 21.6 x 10.8)	6
47683	Square fluted bowl	5.2 (4.9)	10⅝ x 10⅝ x 5½ (25.8 x 25.8 x 13)	2
47684	Square fluted bowl	8.2 (7.9)	11⅞ x 11⅞ x 5⅝ (29.9 x 29.9 x 15)	2
47685	Round fluted bowl	.75 (.7)	5⅝ x 3 (14.4 x 7.6) (dia x h)	6
47686	Round fluted bowl	1.7 (1.6)	7¼ x 4 (18.4 x 10.3) (dia x h)	6
47687	Round fluted bowl	3.4 (3.2)	9½ x 5 (24.1 x 12.9) (dia x h)	6
47688*	Round fluted bowl	6.9 (6.6)	11⅞ x 6½ (30 x 16.5) (dia x h)	2
47689	Round fluted bowl	10.1 (9.6)	13¾ x 6⅞ (35 x 17.5) (dia x h)	2

*See page 223 for false-bottom information

Angled Double-Wall Insulated Serving Bowls



ITEM #	CAPACITY: QT (L)	DIMENSIONS (DIA. X W X H): IN (CM)	CASE LOT
ANGLED BOWLS*			
47650	1 (.95)	7⅞ x 5½ (18.8 x 13.9)	6
47651	1.9 (1.8)	9½ x 6⅞ (24 x 17.3)	6
47652	3.7 (3.5)	11⅞ x 5⅞ (30 x 15)	2
47658	5 (4.7)	13¾ x 9⅞ (35 x 23.8)	2
ANGLED BEEHIVE BOWLS*			
46584	1 (.95)	7⅞ x 5½ (18.8 x 13.9)	6
46585	1.9 (1.8)	9⅞ x 6⅞ (24 x 17.3)	6
46586	3.7 (3.5)	11⅞ x 8¼ (30 x 20.9)	2
46582	5 (4.7)	13¾ x 9⅞ (35 x 23.8)	2

*Round bowl dimensions (top diameter x height): IN (CM)

Double-Wall Insulated Serving Bowls

- Double-wall construction provides insulation to maintain proper food temperature – hot or cold
- Dishwasher safe
- Will not sweat
- Requires no preheating or chilling
- Stainless steel



ITEM #	CAPACITY: QT (L)	DIMENSIONS (L X W X H): IN (CM)	CASE LOT
SQUARE BOWLS			
47659	.75 (.71)	5½ x 5½ x 2¾ (13.9 x 13.9 x 7)	6
47672	1.8 (1.7)	7¼ x 7¼ x 3⅞ (18.4 x 18.4 x 8.7)	12
47674	3.2 (3)	8½ x 8½ x 4¼ (21.6 x 21.6 x 10.8)	6
47675	5.2 (4.9)	10¾ x 10¾ x 5½ (25.8 x 25.8 x 13)	4
47677	8.4 (7.9)	11¾ x 11¾ x 5½ (29.9 x 29.9 x 15)	3
BEEHIVE SQUARE BOWLS			
47619	.75 (.71)	5½ x 5½ x 2¾ (13.9 x 13.9 x 7)	6
47632	1.8 (1.7)	7¾ x 7¾ x 3½ (18.5 x 18.5 x 8.9)	12
47634	3.2 (3)	8⅝ x 8⅝ x 4¼ (21.8 x 21.8 x 10.8)	6
47635	5.2 (4.9)	9⅝ x 9⅝ x 5⅜ (24.4 x 24.4 x 13.1)	4
47637	8.2 (7.8)	11¾ x 11¾ x 5½ (29.9 x 29.9 x 15)	3
BEEHIVE ROUND BOWLS*			
46587	.75 (.7)	5⅞ x 3 (14.4 x 7.6)	6
46590	1.7 (1.6)	7¼ x 4 (18.4 x 10.3)	6
46591	3.4 (3.2)	9½ x 5 (24.1 x 12.9)	6
46592	6.9 (6.6)	11¾ x 6½ (30 x 16.5)	3
46569	10.1 (9.6)	13¾ x 6⅞ (35 x 17.5)	2
SATIN-FINISHED BOWLS WITH CONTRASTING MIRROR-FINISHED RINGS*			
46665	.75 (.7)	5⅞ x 3 (14.4 x 7.6)	6
46666	1.7 (1.6)	7¼ x 4 (18.4 x 10.3)	6
46667	3.4 (3.2)	9½ x 5 (24.1 x 12.9)	6
46668**	6.9 (6.6)	11¾ x 6½ (30 x 16.5)	3
46669	10.1 (9.6)	13¾ x 6⅞ (35 x 17.5)	2

*Round bowl dimensions (top diameter x height): IN (CM) **See page 223 for false-bottom information

Double-Wall Insulated Serving Bowls

- Heavy-gauge stainless steel will not affect taste or color of food
- Mirror-finished exterior for an upscale look
- Satin-finished interior hides scratches and wear



ITEM #	CAPACITY: QT (L)	DIMENSIONS (DIA): IN (CM)	CASE LOT
CONICAL BOWLS			
46575	.62 (.59)	6 ⁵ / ₈ x 2 ³ / ₄ (16 x 6.9)	1
46576	1.4 (1.3)	7 ³ / ₄ x 3 ¹ / ₂ (20 x 8.8)	1
46577	2.5 (2.4)	9 ⁹ / ₃₂ x 4 ¹ / ₄ (24 x 10.8)	1
46578	2.8 (2.6)	11 x 3 ³ / ₈ (28 x 9.8)	1
46579	6.4 (6.1)	11 x 7 ¹ / ₄ (28 x 19.7)	1
46581	1.7 (1.6)	13 x 2 (33 x 5.1)	1
TRUMPET BOWL			
47664	3.4 (3.2)	9 ⁵ / ₈ x 5 ¹ / ₂ (24.5 x 14)	4

Covers for Double-Wall Round Bowls

- 18-8 stainless steel
- Combination satin/mirror finish for beautiful food presentations
- Innovative way to display trayed foods while keeping them cold
- Tray can be used as cover for double-wall bowl or as a stand-alone display item



ITEM #	DIAMETER: IN (CM)	FITS	CASE LOT
82005	5 ¹ / ₈ (14.4)	46587	3
82006	7 ¹ / ₄ (18.4)	46590	10

False Bottom for Double-Wall Round Bowls

- Dome design drains liquid away from food product
- Finger hole for easy removal
- Satin-finished stainless steel

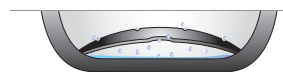

As shown in base of bowl



ITEM #	DESCRIPTION	TOP DIA X HEIGHT: IN (CM)	CASE LOT
46615	For 46592, 46668, and 47688 Bowls	6 ³ / ₄ x 1 ¹ / ₈ (17.2 x 2.1)	6

ELEVATION STANDS & BUFFET RISERS



Elevation Stands

- Durable heavy-duty wire stand with black semi-gloss finish
- Added height makes buffet visually appealing while providing vertical serving space
- Various adaptor plates allow you to use different-sized and -shaped bowls
- Locator tab properly positions adaptor plate for secure fit
- Lifetime warranty on stand welds



ITEM #	DESCRIPTION	RING HEIGHTS: IN (CM)	ACCEPTS BOWLS	DIMENSIONS (L X W X H): IN (CM)	CASE LOT
46540	Staggered-style elevation stand only	5½ (13.97), 7¾ (18.73), 9½ (24.13)	46667, 46591	20¾ x 22¾ x 8¾ (52.7 x 56.8 x 22.1)	1
46541	Ladder-style elevation stand only	3 (7.62), 8¾ (21.9), 13¾ (35.2)	46667, 46591	25½ x 9½ x 13¾ (64.77 x 24.13 x 35.24)	1
46542	ABS adaptor plate – round – medium	—	46666, 46590	7 (17.78) inside diameter	1
46543	ABS adaptor plate – round – small	—	46665, 46587	5½ (13.97) inside diameter	1
46545	ABS adaptor plate – square – large	—	47674, 47634	7¾ (18.73) square cutout	1
46546	ABS adaptor plate – square – medium	—	47672, 47632	6¾ (15.88) square cutout	1
46547	ABS adaptor plate – square – small	—	47659, 47619	5¾ (12.86) square cutout	1

Square Bent Buffet Riser Sets

- Set of 3 risers to add height and interest to any buffet setup
- For use on tabletops or under tablecloths
- Heavy-duty stainless steel construction
- Patented design



4600915



4600960

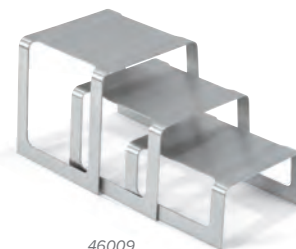

46009

ITEM #	DESCRIPTION	SET INCLUDES	CASE LOT
46009	Set of 3 square bent risers – brushed stainless steel	(1) 8" Riser: 8" x 8" x 8" (20.3 x 20.3 x 20.3 cm), (1) 6" Riser: 8" x 7.5" x 6" (20.3 x 19.1 x 15.2 cm), (1) 4" Riser: 8" x 7" x 4" (20.3 x 17.8 x 10.2 cm)	1
4600915	Set of 3 square bent risers – dazzle red	(1) 8" Riser: 8" x 8" x 8" (20.3 x 20.3 x 20.3 cm), (1) 6" Riser: 8" x 7.5" x 6" (20.3 x 19.1 x 15.2 cm), (1) 4" Riser: 8" x 7" x 4" (20.3 x 17.8 x 10.2 cm)	1
4600960	Set of 3 square bent risers – black black	(1) 8" Riser: 8" x 8" x 8" (20.3 x 20.3 x 20.3 cm), (1) 6" Riser: 8" x 7.5" x 6" (20.3 x 19.1 x 15.2 cm), (1) 4" Riser: 8" x 7" x 4" (20.3 x 17.8 x 10.2 cm)	1
4600950	Set of 3 square bent risers – pearl white	(1) 8" Riser: 8" x 8" x 8" (20.3 x 20.3 x 20.3 cm), (1) 6" Riser: 8" x 7.5" x 6" (20.3 x 19.1 x 15.2 cm), (1) 4" Riser: 8" x 7" x 4" (20.3 x 17.8 x 10.2 cm)	1

PLATE COVERS



Stainless Steel Plate Covers

- Plate covers keep food at its ideal serving temperature for improved customer satisfaction
- Many stock sizes to choose from, or Vollrath can custom-make your plate covers
- Stainless steel
- Satin finish keeps covers looking better longer
- Mirror-finished polish is available at additional charge
- Hemmed finger hole
- Minimum order is 12
- Custom covers available; see page 226 for ordering instructions
- See pages 270-273 for plate and plate cover warewashing racks

ITEM #	FITS PLATES: IN (CM)	HEIGHT: IN (CM)	CASE LOT
62340	8 ¹ / ₁₆ to 8 ³ / ₄ (22 to 22.2)	2 ⁵ / ₁₆ (5.9)	12
62341	8 ³ / ₁₆ to 8 ⁷ / ₈ (22.4 to 22.5)	2 ⁵ / ₁₆ (5.9)	12
62342	8 ¹⁵ / ₁₆ to 9 (22.7 to 22.9)	2 ⁵ / ₁₆ (5.9)	12
62300	9 to 9 ¹ / ₈ (22.9 to 23.2)	2 ⁵ / ₁₆ (5.9)	12
62301	9 ³ / ₁₆ to 9 ¹ / ₄ (23.3 to 23.5)	2 ⁵ / ₁₆ (5.9)	12
62302	9 ⁵ / ₁₆ to 9 ⁵ / ₈ (23.7 to 23.8)	2 ⁵ / ₁₆ (5.9)	12
62303	9 ⁷ / ₁₆ to 9 ¹ / ₂ (24 to 24.1)	2 ⁵ / ₁₆ (5.9)	12
62304	9 ⁹ / ₁₆ to 9 ⁵ / ₈ (24.3 to 24.4)	2 ⁵ / ₁₆ (5.9)	12
62305	9 ¹¹ / ₁₆ to 9 ³ / ₄ (24.6 to 24.8)	2 ⁵ / ₁₆ (5.9)	12
62306	9 ¹³ / ₁₆ to 9 ⁷ / ₈ (24.9 to 25.1)	2 ⁵ / ₁₆ (5.9)	12
62307	9 ¹⁵ / ₁₆ to 10 (25.2 to 25.4)	2 ⁵ / ₁₆ (5.9)	12
62308	10 ¹ / ₁₆ to 10 ¹ / ₈ (25.6 to 25.7)	2 ⁵ / ₁₆ (5.9)	12
62309	10 ³ / ₁₆ to 10 ¹ / ₄ (25.9 to 26)	2 ⁵ / ₁₆ (5.9)	12
62310	10 ⁵ / ₁₆ to 10 ³ / ₈ (26.2 to 26.4)	2 ⁵ / ₁₆ (5.9)	12
62311	10 ⁷ / ₁₆ to 10 ¹ / ₂ (26.5 to 26.7)	2 ⁵ / ₁₆ (5.9)	12
62312	10 ⁹ / ₁₆ to 10 ⁵ / ₈ (26.8 to 27)	2 ⁵ / ₁₆ (5.9)	12
62313	10 ¹¹ / ₁₆ to 10 ³ / ₄ (27.1 to 27.3)	2 ⁵ / ₁₆ (5.9)	12
62314	10 ¹³ / ₁₆ to 10 ⁷ / ₈ (27.5 to 27.6)	2 ⁵ / ₁₆ (5.9)	12
62315	10 ¹⁵ / ₁₆ to 11 (27.8 to 27.9)	2 ⁵ / ₁₆ (5.9)	12
62318	11 ¹ / ₁₆ to 11 ¹ / ₈ (28.1 to 28.3)	2 ⁵ / ₁₆ (5.9)	12
62319	11 ³ / ₁₆ to 11 ¹ / ₄ (28.4 to 28.6)	2 ⁹ / ₁₆ (5.9)	12
62320	11 ⁵ / ₁₆ to 11 ³ / ₈ (28.7 to 28.9)	2 ⁹ / ₁₆ (5.9)	12
62321	11 ⁷ / ₁₆ to 11 ¹ / ₂ (29.1 to 29.2)	2 ⁹ / ₁₆ (5.9)	12
62322	11 ⁹ / ₁₆ to 11 ⁵ / ₈ (29.4 to 29.5)	2 ⁹ / ₁₆ (5.9)	12
62323	11 ¹¹ / ₁₆ to 11 ³ / ₄ (29.7 to 29.8)	2 ⁹ / ₁₆ (5.9)	12
62324	11 ¹³ / ₁₆ to 11 ⁷ / ₈ (30 to 30.2)	2 ⁹ / ₁₆ (5.9)	12
62325	11 ¹⁵ / ₁₆ to 12 (30.3 to 30.5)	2 ⁹ / ₁₆ (5.9)	12
62326	12 ¹ / ₁₆ to 12 ¹ / ₈ (30.6 to 30.8)	2 ⁹ / ₁₆ (5.9)	12
62327	12 ³ / ₁₆ to 12 ¹ / ₄ (31 to 31.1)	2 ⁹ / ₁₆ (5.9)	12
62328	12 ⁵ / ₁₆ to 12 ³ / ₈ (31.3 to 31.4)	2 ⁹ / ₁₆ (5.9)	12
62329	12 ⁷ / ₁₆ to 12 ¹ / ₂ (31.6 to 31.8)	2 ⁹ / ₁₆ (5.9)	12
62330	12 ⁹ / ₁₆ to 12 ⁵ / ₈ (31.9 to 32.1)	2 ⁹ / ₁₆ (5.9)	12
62331	12 ¹¹ / ₁₆ to 12 ³ / ₄ (32.2 to 32.4)	2 ⁹ / ₁₆ (5.9)	12

Custom Platter & Plate Covers Sizing and Imprinting

- Satin-finished stainless steel for longer life
- Custom fit for stability during transport
- Tapered side walls to ensure stackability when in storage
- Finger hole for easy removal
- Extended heights available on request



Oval Platter Cover

Round Plate Cover with optional mirror finish

ORDERING INSTRUCTIONS: Minimum order quantity is 24

OVAL PLATE COVERS

1. Measure width and length of plate.
2. Check the PLC range where both dimensions fall, and select the proper part number and note this on your purchase order. Note: If plate falls into two PLC ranges, select the higher PLC part number.

REFERENCE	PLATTER WIDTH: IN (CM)	PLATTER LENGTH: IN (CM)	COVER HEIGHT: IN (CM)	CASE LOT
PLC-15	8 $\frac{3}{4}$ to 11 $\frac{1}{4}$ (20.9 to 28.5)	9 $\frac{3}{8}$ to 12 $\frac{3}{8}$ (23.8 to 31.4)	2 (5.08)	12
PLC-16	9 $\frac{5}{8}$ to 12 $\frac{3}{8}$ (24.4 to 31.4)	10 $\frac{5}{8}$ to 13 $\frac{3}{8}$ (26.9 to 33.9)	2 (5.08)	12
PLC-17	10 $\frac{7}{8}$ to 13 $\frac{3}{8}$ (27.6 to 34.0)	12 $\frac{1}{2}$ to 15 $\frac{5}{8}$ (30.8 to 39.7)	2 $\frac{3}{4}$ (6.99)	12

ROUND PLATE COVERS

1. Measure five plates at their widest point. Choose the largest one.
2. Select the part number based on plate diameter.

REFERENCE	PLATE DIAMETER IN (CM)	COVER HEIGHT IN (CM)	CASE LOT
PLC-08	7 $\frac{1}{16}$ to 9 (19.5 to 22.86)	2 $\frac{5}{16}$ (5.9)	12
PLC-09	9 to 10 (22.9 to 25.4)	2 $\frac{5}{16}$ (5.9)	12
PLC-10	10 $\frac{1}{16}$ to 11 (25.6 to 27.9)	2 $\frac{5}{16}$ (5.9)	12
PLC-11	11 $\frac{1}{8}$ to 12 (28.1 to 30.5)	2 $\frac{3}{16}$ (7.1)	12
PLC-12	12 $\frac{1}{8}$ to 12 $\frac{3}{4}$ (30.6 to 32.4)	2 $\frac{3}{16}$ (7.1)	12

3. Send the largest platter/plate sample with your purchase order to The Vollrath Company, LLC, Attn: Technical Service, 1236 N. 18th St., Door #1, Sheboygan, WI 53082-0611. Samples are recommended for all custom orders.
4. After we receive the sample and purchase order, we will acknowledge the order with a new part number.
5. We will confirm model numbers and pricing. Vollrath will guarantee pricing only on orders that have been submitted with sample plates. Order fulfillment is not guaranteed.
6. Custom covers will be slightly larger in diameter than sample plate provided to compensate for normal variations. We cannot guarantee our platter covers will stack solidly if platters are warped.
7. Lead time: 3 weeks after receipt of purchase order.
8. Mirror finish: Add "-M" to part number (e.g., PLC-15-M). Additional charge applies.

Note: Custom Plate Covers cannot be canceled or returned. Custom product orders are completed with over/under shipments not to exceed plus or minus 10% of the original order quantity.

Plastic Plate Covers

- Safe-stack plate covers are molded from clear, virtually unbreakable plastic
- Dishwasher safe up to 200° F



1200-13

ITEM #	PLATE DIAMETER: IN (CM)	COVER HEIGHT: IN (CM)	CASE LOT
918-13	8 $\frac{1}{2}$ -9 $\frac{1}{8}$ (21.6-23.2)	2 $\frac{5}{8}$ (6.7)	12
958-13	9 $\frac{1}{8}$ -9 $\frac{5}{8}$ (23.2-24.5)	2 $\frac{5}{8}$ (6.7)	12
978-13	9 $\frac{5}{8}$ -9 $\frac{7}{8}$ (24.5-25.1)	2 $\frac{3}{4}$ (7)	12
1018-13	9 $\frac{7}{8}$ -10 $\frac{1}{8}$ (25.1-25.7)	2 $\frac{3}{4}$ (7)	12
1038-13	10 $\frac{1}{8}$ -10 $\frac{3}{8}$ (25.7-26.2)	2 $\frac{3}{4}$ (7)	12
1078-13	10 $\frac{3}{8}$ -10 $\frac{5}{8}$ (26.7-27)	2 $\frac{3}{4}$ (7)	12
1100-13	11 (27.9)	2 $\frac{3}{8}$ (7.2)	12
1200-13	12 (30.5)	2 $\frac{3}{8}$ (7.2)	12



BAR SERVICE

3-Piece Cocktail Shaker Sets



- Mirror-finished stainless steel
- Crimped top removes easily
- Simple yet elegant design
- Small size perfect for individual service

ITEM #	DESCRIPTION	DIMENSIONS (DIA X H): IN (CM)	CASE LOT
47610	12 oz, beehive style	2½ x 7 (6.4 x 17.8)	10
47612	24 oz, beehive style	3½ x 9 (8.9 x 22.3)	5
47622	22 oz, contemporary style	3½ x 8 (8.9 x 20.3)	12

Shakers & Malt Cup



- Mirror-finished stainless steel
- Reinforced bases
- Malt cup fits Hamilton Beach mixers

SHAKER ITEM #	CAPACITY OZ (ML)	TOP DIAMETER IN (CM)	HEIGHT IN (CM)	CASE LOT
46793	30 (887.2)	3¾ (9.2)	7 (17.8)	12
46791	15 (443.6)	3¾ (8.6)	4½ (11.4)	12
MALT CUP ITEM #				
48070	30 (887.2)	4 (10.2)	6¾ (17.1)	12

Four-Prong Cocktail Strainer and Bar Spoon

- Stainless steel
- Strainer has removable spring for easy cleaning



ITEM #	DESCRIPTION	CASE LOT
46787	Strainer fits standard-size bar shaker	12
46784	Bar spoon measures 11" (27.9 cm) length	24

Stainless Steel Bowls

ALL-PURPOSE BOWL

- Stainless steel
- All-purpose bowl is ideal for mixing, storing, and serving



ICE BOWL

- Mirror-finished stainless steel
- Gadroon top is ideal for ice, drink garnishes, and bar snacks



ITEM #	DESCRIPTION	CAPACITY OZ (ML)	DIMENSIONS (W X H): IN (CM)	CASE LOT
54422	All-purpose	24 (709.8)	5 x 3¼ (12.7 x 8.3)	24
47914	Ice bowl	40 (1182.9)	7 x 3¼ (17.8 x 8.3)	12

Stainless Steel Ice Bucket and Ice Tongs

STAINLESS STEEL ICE BUCKET

- Mirror-finished exterior, satin-finished interior
- Welded handles for easy transportation
- Compact design fits neatly on tabletop or is perfect for room service



ICE TONGS

- Stainless steel
- Beautiful hammered finish



ITEM #	DESCRIPTION	CAPACITY QT (L)	DIMENSIONS IN (CM)	CASE LOT
46621	Ice bucket	1.6 (1.5)	5½ x 5½ (15 x 14) dia x h	24
47104	Ice tongs	—	6¼ (15.9) length	12

Scoops

STAINLESS STEEL SCOOPS

- Heavy-duty stainless steel
- Mirror-finished inside, satin-finished outside
- Use for ice, sugar, or other dry ingredients



CAST ALUMINUM SCOOPS

- One-piece construction with capacity stamped on handle
- Rounded handle with ergonomic finger grips



ITEM #		CAPACITY: OZ (ML)	BOWL SIZE: IN (CM)	LENGTH: IN (CM)	CASE LOT
STAINLESS STEEL SCOOPS					
92110	Stainless steel scoop	52 (1537.8)	7 $\frac{1}{4}$ x 5 $\frac{1}{4}$ (20 x 13.3)	4 (10.2) handle	6
46790*	Stainless steel bar scoop	5 $\frac{1}{2}$ (162.7)	5 x 2 $\frac{1}{2}$ (12.7 x 6.4)	9 $\frac{1}{2}$ (24.1) overall	24
CAST ALUMINUM SCOOPS					
46890	Cast aluminum scoop	5 (147.9)	4 $\frac{3}{4}$ x 2 $\frac{3}{8}$ (12.1 x 6)	7 $\frac{3}{8}$ (18.2)	24
46891	Cast aluminum scoop	12 (354.9)	6 $\frac{1}{4}$ x 3 $\frac{1}{8}$ (15.9 x 7.9)	8 $\frac{3}{8}$ (22.4)	24
5280	Cast aluminum scoop	18 (532.2)	5 $\frac{1}{2}$ x 3 (14 x 7.6)	—	6
46892	Cast aluminum scoop	24 (709.7)	8 x 4 (20.3 x 10.2)	10 $\frac{3}{4}$ (27.3)	24
46893	Cast aluminum scoop	38 (1123.7)	9 x 4 $\frac{1}{4}$ (22.9 x 12.1)	12 $\frac{1}{4}$ (31)	24
46894	Cast aluminum scoop	58 (1715.2)	10 $\frac{1}{2}$ x 5 $\frac{1}{2}$ (26.7 x 14)	14 $\frac{3}{8}$ (36.6)	20
46895	Cast aluminum scoop	85 (2513.7)	12 x 6 $\frac{1}{4}$ (30.5 x 15.9)	15 $\frac{1}{2}$ (39.8)	20

*46790 not NSF® certified

Ice Caddy

- Unique lid attachment prevents loss (non-metal hinges)
- Lock can be placed through tag hole for secure, tamper-proof storage
- A slanted top fits under counter for space-saving storage
- 4 non-marking 5" swivel casters with locking brakes
- Recessed drain prevents breakage
- Front lid slides down front of unit to protect from exposure and prevent cross-contamination



ITEM #	DESCRIPTION	DIMENSIONS L X W X H: IN (CM)	CASE LOT
ICE140-06	Ice Caddy, 140 lb capacity	36 x 27 $\frac{1}{4}$ x 30 $\frac{5}{8}$ (91.4 x 69.2 x 77.4)	1

Traex® Bar Keep™ II Storage



- Kit includes (1) neck, (1) jar, (1) lid, and (6) assorted-color standard spouts

ITEM #	DESCRIPTION	CAPACITY: QT (L)	DIMENSIONS: IN (CM)	CASE LOT
3616	Bar Keep™ II storage kit – 1 pint	.5 (.47)	10 $\frac{1}{2}$ x 3 $\frac{1}{8}$ (25.7 x 9.2)	12
3632	Bar Keep™ II storage kit – 1 quart	1 (.95)	13 $\frac{3}{8}$ x 3 $\frac{1}{4}$ (34 x 9.5)	12
3648	Bar Keep™ II storage kit – 48 oz	1.5 (1.4)	15 x 6 $\frac{1}{2}$ (38.1 x 16.5)	6
3664	Bar Keep™ II storage kit – .5 gal	2 (1.9)	13 $\frac{3}{4}$ x 5 (35 x 12.7)	6
3628	Bar Keep™ II storage kit – 1 gal	4 (3.8)	17 x 5 $\frac{1}{2}$ (43.2 x 13.4)	6
REPLACEMENT PARTS				
3604A	Neck only	—	—	12
3605A-05	Lid only, white	—	—	12
3606A-99	Standard spout in assorted colors	—	—	1

Traex® Kondi-Keeper™ Condiment Dispensers

- Self-closing lid
- Contemporary design
- Plastic models are NSF® certified
- Stainless steel model has no bottom and is meant to sit on ice
- Positive stacking
- Reduces contamination
- Refreezable bottles fit under inserts, keeping condiments cool and fresh longer
- Not recommended for dishwashers
- Clear polycarbonate lid for easy viewing
- Domed design increases capacity and allows for overfill
- Notched lids allow you to keep spoons in place with lid closed



ITEM #*	DESCRIPTION	EXTERIOR FINISH	CAPACITY	INSERTS	DIMENSIONS: IN (CM)	CASE LOT
CONDIMENT DISPENSERS						
4741-xx*	Condiment dispenser w/pint inserts and standard lid	Plastic	4 pt (1.9 L)	4	12 x 6 x 4½ (30.5 x 15.2 x 11.4)	1
4743-xx*	Condiment dispenser w/pint inserts and standard lid	Plastic	6 pt (2.8 L)	6	18 x 6 x 6½ (45.7 x 15.2 x 15.6)	1
4746-xx*	Condiment dispenser w/pint inserts and standard lid	Plastic	8 pt (3.8 L)	8	24 x 6 x 4½ (61 x 15.2 x 11.4)	1
4762-xx*	Condiment dispenser w/quart inserts and notched lid	Plastic	3 qt (3.3 L)	3	18 x 6 x 6½ (45.7 x 15.2 x 15.6)	1
4742-xx*	Condiment dispenser w/quart inserts and standard lid	Plastic	3 qt (3.3 L)	3	18 x 6 x 6½ (45.7 x 15.2 x 15.6)	1
4740-xx*	Condiment dispenser w/quart inserts and standard lid	Plastic	2 qt (2.2 L)	2	12 x 6 x 4½ (30.5 x 15.2 x 11.4)	1
4745-xx*	Condiment dispenser w/quart inserts and standard lid	Plastic	4 qt (4.4 L)	4	24 x 6 x 4½ (61 x 15.2 x 11.4)	1
4701	Condiment dispenser w/pint inserts and standard lid	Stainless steel	4 pt (1.9 L)	4	12 x 6 x 4½ (30.5 x 15.2 x 11.4)	1
4702	Condiment dispenser w/pint inserts and standard lid	Stainless steel	6 pt (2.8 L)	6	18 x 6 x 4½ (45.7 x 15.2 x 11.4)	1
4705	Condiment dispenser w/quart inserts and standard lid	Stainless steel	3 qt (3.3 L)	3	18 x 6 x 4½ (45.7 x 15.2 x 11.4)	1
CONDIMENT DISPENSER ACCESSORIES						
4747	Refreezable bottle	—	—	—	5½ x 4½ x 1½ (13.2 x 11.4 x 2.9)	6
4801**	1 pint insert	—	1 pt (.47 L)	—	2½ x 3 x 5½ (7.3 x 7.6 x 14.9)	24
4720	1 pint insert cover	—	—	—	—	24
4802**	1 quart insert	—	1 qt (.95 L)	—	2½ x 5½ x 5½ (7.3 x 14.9 x 14.9)	12
4721	1 quart insert cover	—	—	—	—	24
529-13	Condiment spoon	—	—	—	5¼ (13.3) length	6

*Add suffix to designate color at XX (brown -01, black -06) **Cover sold separately

Bar Mats

- Flexible thermoplastic rubber

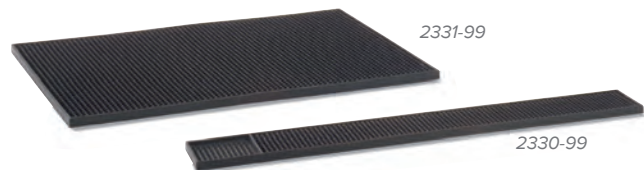

ITEM #	DESCRIPTION	COLOR	DIMENSIONS: IN (CM)	CASE LOT
2330-99	Rail-mate glass rail mat	Black	23½ x 3¾ x ½ (56.7 x 7.9 x 1.3)	12
2331-01	Service mat	Brown	18 x 12 x ½ (45.7 x 30.5 x 1.3)	6
2331-99	Service mat	Black	18 x 12 x ½ (45.7 x 30.5 x 1.3)	6



WINE SERVICE

Wine/Champagne Buckets

- Heavy-duty mirror-finished stainless steel



Silverplate available for some items
– see more at VOLLRATH.com.

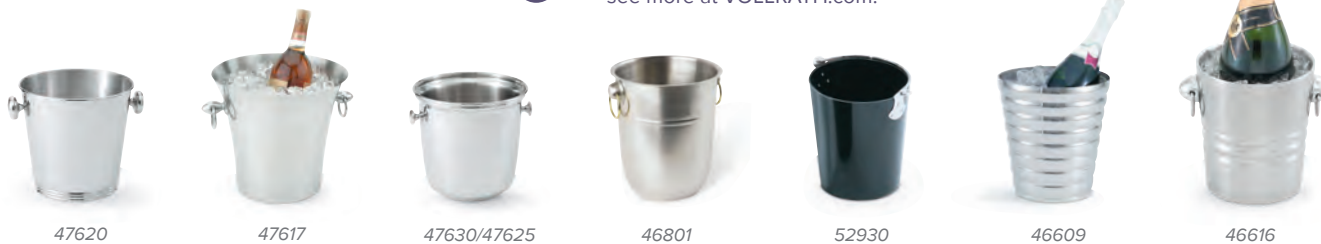

ITEM #	SILVERPLATE ITEM #	DESCRIPTION	DIMENSIONS (DIA X H) IN (CM)	BOTTOM DIAMETER IN (CM)	FITS STAND ITEM #	CASE LOT
47620						
47617						
47630/47625						
46801						
52930						
46609						
46616						
47630	48330	Bucket w/handles, mirror-finished stainless steel	8¼ x 8 (21 x 20.3)	—	47611	1
47625	48325	Double bucket w/handles, mirror-finished stainless steel	9½ x 9½ (25.1 x 23.2)	—	47621	1
47620*	48320*	Bucket w/handles, mirror-finished stainless steel	8¼ x 7¾ (21 x 19.7)	—	47611	1
46609	—	Beehive-style, heavy-gauge mirror-finished stainless steel, tabletop use	7½ x 7½ (19 x 20)	5½ (13.7)	—	1
47617*	—	Fluted-style mirror-finished interior and top rim steel, tabletop or stand	9¾ x 8¾ (24 x 22.2)	6½ (16.5)	47611	1
46801	—	Satin-finished stainless steel, stand use only	8¾ x 10½ (22.2 x 25.7)	6 (15.2)	46800	6
46616	—	Double-wall, stainless steel	8 x 7 (20.3 x 17.8)	5½ (14.1)	47611	6
52930	—	Wine cooler, black plastic	8 x 10 (20.3 x 25.4)	6½ (16.5)	47611, 46800	3

*For use on tabletop or in stand

Double-Wall Insulated Wine Coolers

- Stainless steel
- Keeps wines or champagnes chilled for up to 4 hours
- No ice or pre-chilling required, no sweat
- Small footprint takes up very little table space



ITEM #	DESCRIPTION	EXTERIOR FINISH	INTERIOR FINISH	DIMENSIONS (DIA X H): IN (CM)	CASE LOT
47615	Double-wall beehive cooler	Mirror finish	Satin finish	4½ x 7½ (11.4 x 20)	1
47605	Double-wall straight-sided cooler	Satin finish	Satin finish	4½ x 7¾ (11.4 x 19.7)	1
47616	Double-wall hourglass cooler	Mirror finish	Satin finish	5½ x 8½ (14.8 x 22)	1

Wine/Champagne Bucket Stands

ITEM #	SILVERPLATE ITEM #	DESCRIPTION	DIMENSIONS (DIA X H): IN (CM)	CASE LOT
47611	48311	Single bottle stand, for 46616, 47617, 47620, 47630, and 52930 buckets	7¾ x 23½ (19.7 x 60)	1
47621	48321	Double bottle stand, for 47625 bucket	8½ x 23½ (21.9 x 60)	1
46800	—	Stand only, for 46801 and 52930 buckets		1

Note: Buckets and stands sold separately



47611
Bucket
stand sold
separately

Double-Wall Conical Stainless Steel Beverage Bins and Floor Beverage Stand

- Moves beverages off the tabletop, leaving more room for food presentation/serving
- Double-wall construction won't sweat
- Black stand matches any décor
- Lifetime warranty on stand welds

47226



47225
bin with
46548
stand



ITEM #	DESCRIPTION	OUTSIDE DIMENSIONS (TOP DIA X H X BOTTOM DIA): IN (CM)	GALLON (L)	CASE LOT
47226	Tabletop beverage bin	14½ x 7 x 11¼ (36.8 x 17.8 x 28.6)	3 (11.3)	1
47225	Double-wall conical beverage bin	18 x 8¼ x 15 (45.7 x 20.9 x 38.1)	5 (19.0)	1
46548	Floor stand for beverage bin 47225	13¾ (34.9) dia x 26 (66) h	—	1

Traex® Melamine Cocktail Plate

- Dishwasher safe
- Holds glasses with a bottom diameter of 1¹⁵/₁₆"-2¹/₂"
- Made of tough melamine

CP8-06



ITEM #	DESCRIPTION	COLOR	DIMENSIONS (L X W): IN (CM)	CASE LOT
CP8-06	Cocktail plate	Black	8 x 8 (20.3 x 20.3)	12

Wire Flight Caddies

- Ideal for beverage or food sampling
- Dishwasher safe
- Easy finger grip
- Glasses not included



WR-1026-06



WR-1027-06



WR-1028-06

ITEM #	DESCRIPTION	CAPACITY	MAX GLASS DIAMETER IN (CM)	MAX GLASS STEM LENGTH IN (CM)	DIMENSIONS (DIA X H) IN (CM)	CASE LOT
WR-1026-06	Circular wire flight caddy	6 glasses	3½ (8.9)	4¾ (12.1)	9 x 11 (22.9 x 27.9)	1
WR-1027-06	Circular wire flight caddy	3 glasses	4¾ (10.8)	4¾ (12.1)	7 x 11 (17.8 x 27.9)	1
WR-1028-06	Inline wire flight caddy	3 glasses	3½ (8.9)	—	11½ x 7¾ (28.3 x 19.4)	1

Bottle Coaster/Spoon Rest

- Mirror-finished stainless steel
- Accommodates all standard wine bottles
- Wide-rim design helps prevent spills onto tablecloth
- Ideal for use as a spoon rest, a cover for small ice bucket (46621, page 227), or a small appetizer/dessert plate



ITEM #	DESCRIPTION	DIAMETER: IN (CM)	CASE LOT
46622	Bottle coaster/spoon rest	6¾ (15.6)	24

Vacuum Wine Saver/Stopper

- Maintains wine quality by removing excess oxygen
- Pump and wine stopper in one unit
- Creates vacuum seal – no leaking
- Textured sides provide sure grip
- Ideal for operators selling wine by the glass
- Allows for upright or horizontal storage
- Dishwasher safe



ITEM #	DESCRIPTION	DIMENSIONS: IN (CM)	CASE LOT
47609	Vacuum wine saver/stopper	4 x 1¼ (10.2 x 4.4)	6

Pulltap's™ Waiter's Corkscrew



- Patented double-lever system makes removing the cork effortless
- Ergonomic curved handle
- Five-turn Teflon®-coated forged steel
- Serrated capsule cutting blade provides easy removal of foil
- Finest waiter's corkscrew you can buy
- Custom imprinting available; contact your Vollrath representative for more details

ITEM #	DESCRIPTION	SCREW LENGTH IN (CM)	OVERALL LENGTH* IN (CM)	CASE LOT
47602	Hinged design	2 (5.1)	4½ (11.7)	10

*Closed position

Champagne Stopper



- Patented slide feature creates easy, quick seal on bottle
- Unique PVC interior stopper provides tight seal and extends life of champagne
- Easy to clean
- Dishwasher safe

ITEM #	DESCRIPTION	DIMENSIONS: IN (CM)	CASE LOT
46774	Champagne stopper	2½ x 1½ x 1½ (6.7 x 4.8 x 3.8)	12 packages (2 per package)

Wine Stopper

- Unique PVC interior stopper provides tight seal and extends life of wine
- Easy to put on and take off – saving time and effort
- ABS plastic exterior is durable, sanitary, and easy to clean
- Dishwasher safe



ITEM #	DESCRIPTION	DIMENSIONS: IN (CM)	CASE LOT
46773	Wine stopper	1½ x 1½ (4.1 x 3.8)	12 packages (2 per package)

Corkscrews



WAITER'S CORKSCREW

- Stainless steel
- Pocket style with knife, cork, and cap lifter

WINGED CORKSCREW

- Gear lever action lifter affords easy removal of cork

ITEM #	DESCRIPTION	LENGTH: IN (CM)	CASE LOT
46789	Waiter's corkscrew	4½ (11.7)	12
46788	Winged corkscrew and cap lifter	7¼ (18.4)	12

Champagne Stopper



- Mirror-finished stainless steel
- For use with champagne, sparkling wine, and mineral water bottles
- Spring-loaded design creates a tight fit for better sealing

ITEM #	DESCRIPTION	CASE LOT
47603	Butterfly-style champagne stopper, stainless steel	12

PITCHERS & CREAMERS



Triennium™ Beverage Service

- Stainless steel is resistant to corrosion, pitting, and rusting
- Unique triangular body design elevates the overall appearance of any establishment
- Sturdy hidden hinge design for greater durability
- Seamless spouts offer an elegant look, precise directional pouring, and easy cleaning
- Dishwasher safe

MIRROR-FINISHED	SATIN-FINISHED	DESCRIPTION	CAPACITY	HEIGHT: IN (CM)	CASE LOT
46200	46300	Coffee pot	10 oz (.3 L)	7 $\frac{1}{2}$ (20)	1
46202	–	Coffee pot	34 oz (1.0 L)	6 $\frac{1}{2}$ (15.6)	1
46203	46303	Coffee pot	2.3 qt (2.2 L)	8 $\frac{3}{4}$ (21.3)	1
46204	46304	Water pitcher	2.3 qt (2.2 L)	7 $\frac{1}{2}$ (20)	1
46206	46306	Water pitcher with ice guard	2.3 qt (2.2 L)	7 $\frac{1}{2}$ (20)	1
46207	46307	Tea pot	12 oz (.35 L)	3 (7.6)	1
46208	46308	Open creamer	9 oz (.29 L)	3 $\frac{3}{4}$ (9.5)	1
46209	46309	Covered creamer	9 oz (.29 L)	3 $\frac{3}{4}$ (9.5)	1
–	46400	Covered sugar bowl	8.5 oz (.25 L)	2 $\frac{1}{4}$ (5.7)	1

Orion™ Beverage Service

- Mirror-finished exterior, satin-finished interior, stainless steel
- Gooseneck spouts for easy pouring while offering an elegant design
- Hollow handle insulates for comfortable pouring
- Sturdy hinge for greater durability



ITEM #	DESCRIPTION	CAPACITY: OZ (L)	HEIGHT: IN (CM)	CASE LOT
46593	Coffee pot	12 (.35)	4 $\frac{1}{2}$ (11.4)	1
46594	Coffee pot	20 (.6)	5 $\frac{1}{8}$ (13.0)	1
46595	Coffee pot	34 (1)	5 $\frac{7}{8}$ (15.0)	1
46596	Coffee pot	68 (2)	7 $\frac{1}{16}$ (19.5)	1
46597	Sugar server	12 (.35)	3 $\frac{3}{8}$ (8.5)	1
46598	Covered creamer	12 (.35)	4 $\frac{1}{2}$ (11.4)	1
46633	Open creamer	8 (.25)	3 $\frac{1}{2}$ (8.9)	1
46634	Water pitcher	68 (2)	6 $\frac{3}{4}$ (17.1)	1



Water Pitchers

- Welded ice guard reduces splashing and spills for trouble-free pouring
- Welded hollow tubular handles insulate for comfortable pouring
- 81020 is straight sided with a bright finish, made in USA, and NSF® certified; no ice guard

ITEM #	DESCRIPTION	CAPACITY: QT (L)	HEIGHT: IN (CM)	DIAMETER: IN (CM)	CASE LOT
46599	Water pitcher, mirror-finished exterior, satin-finished interior, stainless steel, welded hollow tubular handle insulates for comfortable pouring	1.9 (1.8)	9 ⁵ / ₈ (23)	—	1
68174	Water pitcher, satin-finished aluminum, ice guard, riveted handle	2 ¹ / ₂ (2)	7 ⁷ / ₈ (20.1)	—	12
46403	Water pitcher, stainless steel	2 (1.9)	9 ¹ / ₄ (23.5)	—	1
46402	Water pitcher, stainless steel, welded hollow tubular handle insulates for comfortable pouring	2 (1.9)	7 ¹ / ₄ (18.4)	—	6
81020	Water pitcher, bright-finish stainless steel, no ice guard	2 (1.9)	6 ³ / ₈ (16.2)	5 ¹ / ₂ (13)	4

Stainless Steel Pitcher



- Elegant brushed-satin stainless steel exterior and mirror-polished stainless steel interior
- Designed for perfect pouring with an ergonomic handle

ITEM #	CAPACITY: QT (L)	DIMENSIONS: IN (CM)	CASE LOT
465312	3 (2.8)	9 ¹ / ₄ x 6 ¹ / ₂ x 9 ¹ / ₄ (23.5 x 16.5 x 23.5)	1

Double-Wall Pitcher



- Double-wall construction provides insulation to maintain proper temperature and will not sweat
- Dishwasher safe
- Mirror-finished 18-8 stainless steel

ITEM #	CAPACITY: QT (L)	DIMENSIONS: IN (CM)	CASE LOT
46550	2 (1.9)	11 ¹ / ₂ x 6 ¹ / ₂ x 8 ³ / ₄ (28.2 x 16.5 x 22.2)	1

Bell-Shaped Pitchers



- High-quality stainless steel seamless construction and satin finish
- All-welded handles
- Hollow handle insulates for comfortable pouring



ITEM #	CAPACITY: QT (L)	HEIGHT: IN (CM)	CASE LOT
82020	2 ¹ / ₂ (2)	8 (20.3)	4
82030	3 ³ / ₈ (2.9)	9 (22.9)	4
82040	4 ³ / ₈ (3.9)	10 ³ / ₈ (26.4)	4
92020	2 ¹ / ₂ (2)	8 (20.3)	4

Traex® Beverage Pitchers



6000-13

6010-13



611-0606

- 6010-13 clear pitcher is NSF® certified
- Virtually unbreakable polycarbonate
- Thumb-grip pour control and ice catcher pour lip
- Dishwasher safe

ITEM #	DESCRIPTION	CAPACITY OZ (L)	DIMENSIONS IN (CM)	CASE LOT
6010-XX	Three-lip deluxe pitcher – choose color suffix	60 (1.8)	8 ⁵ / ₈ x 4 ⁷ / ₈ (21.9 x 12.4)	12
6000-13	Deluxe clear pitcher	60 (1.8)	9 ¹ / ₄ x 5 ¹ / ₂ (23.5 x 13)	12
611-0606	Black beverage coaster	—	6 x 6 (15.2 x 15.2)	12

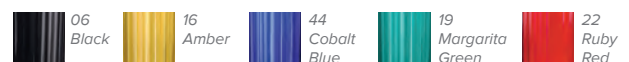

SwirlServe® Beverage Servers

- Orange, brown, and white tabs allow for easy differentiation
- Durable polypropylene inner liner is odorless and stain resistant
- Polyurethane insulation in body and cover
- Exterior looks like porcelain but is actually impact-resistant ABS plastic
- Hand-wash only



Tilt & Pour® SwirlServe Beverage Servers

- Unique pouring system lets you pour without pressing buttons
- Self-closing spout disassembles for easy cleaning
- Covers are interchangeable with SwirlServe® covers

BLACK ITEM #	WHITE ITEM #	CAPACITY: OZ (ML)	CASE LOT
52126	52124	10 (295)	12
52142	52132	20 (591)	12
52140	52130	42 (1242)	12
52144	52134	64 (1892)	6

BLACK COVER ITEM #	WHITE COVER ITEM #	COVER CASE LOT
52127	52125	6
52143	52133	6
52141	52131	6
52145	52135	6

SwirlServe Hot-N-Cold Beverage Servers

- Covers are interchangeable with Tilt & Pour® covers



See results of the SwirlServe Beverage Server heat retention test at VOLLRATH.com.



BLACK ITEM #	WHITE ITEM #	CAPACITY: OZ (ML)	CASE LOT
52122	52120	10 (295)	12
52172	52162	20 (591)	12
52170	52160	42 (1242)	12
52174	52164	64 (1892)	6

BLACK COVER ITEM #	WHITE COVER ITEM #	COVER CASE LOT
52123	52121	6
52173	52163	6
52171	52161	6
52175	52165	6

Tea and Coffee Servers

- Mirror-finished stainless steel
- Hollow handles insulate for comfortable pouring



ITEM #	SILVERPLATE ITEM #	DESCRIPTION	CAPACITY OZ (ML)	HEIGHT IN (CM)	CASE LOT
COFFEE SERVER WITH GADROON BASE					
46565	48365	Hollow handle	64 (1.9)	8½ (21.6)	6
TEA AND COFFEE SERVERS WITH BUILT-IN STRAINER FOR SERVING TEA					
46314	—	Flat handle	10 (.3)	4¼ (10.8)	12
46370	—	Hollow handle	12 (.4)	4 (10.2)	12

Coffee Decanters

- Mirror-finished stainless steel
- Comfortable black plastic handle
- Designed to fit standard stove top and coffee warmers



ITEM #	DESCRIPTION	CAPACITY OZ (ML)	HEIGHT IN (CM)	CASE LOT
46570	Plain	2 (1.9)	6½ (16.5)	1
46580	Decaf	2 (1.9)	6½ (16.5)	1

Economy Servers



- Mirror-finished stainless steel
- Hinged lid with thumb tab for single-handed easy refilling
- Recessed cover design allows stacking for compact storage

ITEM #	DESCRIPTION	CAPACITY OZ (ML)	HEIGHT IN (CM)	CASE LOT
46210	Closed handle	10 (296)	4 (10.2)	12
46212	Stacking server	10 (296)	3¾ (8.3)	12

Double-Wall Insulated Server



- Insulated server
- Mirror-finished stainless steel
- Double-wall construction for moisture-free exteriors and excellent temperature retention
- Easy-to-clean seamless interiors

ITEM #	DESCRIPTION	CAPACITY OZ (ML)	HEIGHT IN (CM)	CASE LOT
46613	Server with hinged insulated cover	10 (296)	3¾ (8.3)	12

Hammered Creamers and Servers



- Finish on hammered creamers and servers enhances style and minimizes noticeable wear
- Stainless steel

ITEM #	DESCRIPTION	CAPACITY OZ (ML)	HEIGHT IN (CM)	CASE LOT
T4030HH	Bell-shaped hammered creamer	3 (88)	2 (5.1)	12
T4050HH	Bell-shaped hammered creamer	5 (148)	2¾ (7)	12
T4080HH	Bell-shaped hammered creamer	8 (237)	3 (7.6)	12
T4710HH	Gooseneck hammered server	10 (300)	4¾ (10.8)	12

Bell Creamers



- Mirror-finished stainless steel
- Excellent choice for serving cream, sauces, and dressings

ITEM #	DESCRIPTION	CAPACITY OZ (ML)	HEIGHT IN (CM)	CASE LOT
46003	Bell creamer	3 (89)	2 (5.1)	24
46005	Bell creamer	5 (148)	2¾ (7)	12
46008	Bell creamer	8 (237)	3¾ (7.9)	12

Gooseneck Servers



- Mirror-finished stainless steel
- Hollow handle insulates for comfortable pouring

ITEM #	SILVERPLATE ITEM #	DESCRIPTION	CAPACITY OZ (ML)	HEIGHT IN (CM)	CASE LOT
46310	—	Traditional	10 (296)	4¾ (10.8)	12
46312	48312	Gadroon edge	10 (296)	4¾ (12.1)	12

Creamer/Servers



- Mirror-finished stainless steel
- Hinged lid with thumb tab for single-handed refilling

ITEM #	SILVERPLATE ITEM #	DESCRIPTION	CAPACITY OZ (ML)	HEIGHT IN (CM)	CASE LOT
46205	—	Gadroon base	5 (148)	3½ (8.9)	12
46516	—	Standard	10 (296)	4 (10.2)	12
46560	48360	Gadroon base	10 (296)	4½ (11.4)	12
46517	48317	Gadroon base	16 (473)	5½ (14)	12

 Silverplate available for gooseneck servers and creamer/servers – see more at VOLLRATH.com.



BOWLS & RAMEKINS

MULTIPURPOSE BOWLS & SERVING ESSENTIALS

Multi-Purpose Bowls

- Stainless steel
- Mirror-finished outside and top rim
- Satin-finished interior for longer life
- Ideal for punch, salads, fresh fruit, or pasta



82144

ITEM #	DESCRIPTION	CAPACITY: QT (L)	TOP DIAMETER X HEIGHT: IN (CM)	CASE LOT
82144	Multi-purpose bowl	11 (10.6)	15 ⁹ / ₃₂ x 8 ¹ / ₂ (39.6 x 21.6)	1
82146	Multi-purpose bowl	17.5 (16.5)	18 x 9 ³ / ₁₆ (45.7 x 25)	1

Condiment Server

- Stainless steel – resistant to corrosion, pitting, and rusting
- Ideal for nuts, mints, chocolate, and candy – for bars and tables
- Stainless steel hollow-rod handle provides easy surface to grab and transport servers



ITEM #	DESCRIPTION	SINGLE-BOWL CAPACITY: OZ (L)	OVERALL HEIGHT: IN (CM)	BOWL DIAMETER: IN (CM)	CASE LOT
46636	3-bowl condiment server	4 (12)	3 ³ / ₄ (8.3)	3 ³ / ₈ (9.8)	1

Oval Bowl

- Mirror-finished stainless steel basket is ideal for breads, rolls, and fruit



ITEM #	DESCRIPTION	CAPACITY: QT (L)	OVERALL DIMENSIONS (L X W X H): IN (CM)	CASE LOT
46624	Oval bowl	1.7 (1.6)	10 ⁹ / ₁₆ x 7 x 2 ⁵ / ₁₆ (27.1 x 17.8 x 5.9)	1

Tureen

- Stainless steel
- Sturdy welded base and side handles



ITEM #	DESCRIPTION	CAPACITY: QT (L)	HEIGHT W/BASE: IN (CM)	CASE LOT
47845	Tureen	5 (4.7)	4 ⁷ / ₈ (12.4)	6

Flared Sauce Cups

- Stainless steel
- Mirror-finished outside, satin-finished inside
- Retains temperature longer (than plastic or melamine)
- Flared design is attractive and allows for easier dipping and pouring



ITEM #	DESCRIPTION	CAPACITY: OZ (ML)	HEIGHT: IN (CM)	TOP DIAMETER: IN (CM)	CASE LOT
46714	Flared stainless steel sauce cup	4 (118)	1 ³ / ₄ (4.1)	3 (7.6)	12
46716	Flared stainless steel sauce cup	6 (177)	1 ⁵ / ₈ (4.6)	3 ³ / ₄ (9.5)	12

Sauce Cup

- Stainless steel retains temperature longer and helps reduce food waste
- Mirror-finished outside, satin-finished inside
- Sized for individual condiment service



ITEM #	CAPACITY OZ (ML)	HEIGHT IN (CM)	TOP DIAMETER IN (CM)	CASE LOT
46713	3 (89)	1 ¹ / ₂ (4.1)	2 ³ / ₈ (6.5)	12

Ramekin



ITEM #	DESCRIPTION	CAPACITY: OZ (ML)	CASE LOT
533-06	Smooth ramekin, black	2 (59)	72

Sizzling Platter and Underliner

- Heavy-duty 16-gauge stainless steel for greater durability
- Features built-in handles for easy, comfortable handling
- Constructed from high-temperature polyester, underliner helps maintain temperature for greater customer satisfaction
- Underliner resists chipping and breaking
- Dishwasher safe



ITEM #	DESCRIPTION	DIMENSIONS L x W: IN (CM)	CASE LOT
81170	Oval platter with underliner	13 ³ / ₄ x 8 ⁵ / ₈ (34.9 x 21.1)	12
81180	Oval platter only	11 ³ / ₄ x 7 ³ / ₄ (29.8 x 19.7)	12
81190	Oval underliner only	13 ³ / ₄ x 8 ⁵ / ₈ (34.9 x 21.1)	12

Stainless Steel Au Gratin

- Mirror-finished stainless steel
- Go straight from oven or broiler to table
- Integral handle



ITEM #	CAPACITY: OZ (ML)	OVERALL DIMENSIONS L x W x H: IN (CM)	INSIDE DIAMETER: IN (CM)	CASE LOT
47428	8 (236)	8 x 4 ¹ / ₂ x 1 ¹ / ₈ (20.3 x 11.4 x 2.9)	–	12
47422	12 (355)	9 x 5 x 1 ¹ / ₈ (22.9 x 12.7 x 3.5)	–	12
47425	15 (443)	10 ¹ / ₂ x 5 ³ / ₄ x 1 ¹ / ₈ (26.7 x 14.6 x 3.5)	–	12
47429	20 (591)	10 ¹ / ₂ x 6 x 1 ¹ / ₈ (26.7 x 15.2 x 3.5)	–	12
47406	6 (177)	6 ³ / ₄ (17.1) outside diameter	5 ¹ / ₂ (14)	12
47408	8 (236)	7 ¹ / ₄ (18.4) outside diameter	5 ³ / ₄ (14.6)	12



FLATWARE

Mariner Flatware

- Elegant scalloped pattern
- Mirror-finished, extra-heavyweight
- 18% chrome stainless steel



ITEM #	DESCRIPTION	LENGTH: IN (CM)	CASE LOT
48200	Teaspoon	6 $\frac{1}{8}$ (15.6)	1 dz
48203	Dessert spoon	7 (17.8)	1 dz
48205	Bouillon spoon	6 $\frac{1}{8}$ (15.6)	1 dz
48204	Iced tea spoon	7 $\frac{1}{2}$ (19.1)	1 dz
48208	Serving spoon	8 $\frac{1}{4}$ (21)	1 dz
48201	Dinner fork	7 $\frac{5}{8}$ (19.4)	1 dz
48207	4-tine salad fork	7 (17.8)	1 dz
48206	Oyster/shrimp fork	5 $\frac{5}{8}$ (14.3)	1 dz
48202	Dinner knife, solid handle	8 $\frac{3}{4}$ (22.2)	1 dz
48209	Butter knife, solid handle	6 $\frac{1}{8}$ (15.6)	1 dz

Brocade Flatware

- Elegant trim
- Mirror-finished, heavyweight
- 18% chrome stainless steel



ITEM #	DESCRIPTION	LENGTH: IN (CM)	CASE LOT
48220	Teaspoon	6 $\frac{3}{8}$ (16.2)	1 dz
48223	Dessert spoon	7 $\frac{3}{8}$ (18.7)	1 dz
48225	Bouillon spoon	6 $\frac{1}{8}$ (15.6)	1 dz
48224	Iced tea spoon	7 $\frac{3}{8}$ (18.7)	1 dz
48228	Serving spoon	8 $\frac{1}{4}$ (21)	1 dz
48221	Dinner fork	7 $\frac{1}{2}$ (19.1)	1 dz
48227	4-tine salad fork	6 $\frac{1}{2}$ (16.5)	1 dz
48226	Oyster/shrimp fork	5 $\frac{3}{8}$ (14.6)	1 dz
48222	Dinner knife, solid handle	8 $\frac{3}{8}$ (22.5)	1 dz

Steak Knives

- Hand-washing will prolong life of product



ITEM #	DESCRIPTION	BLADE LENGTH: IN (CM)	OVERALL LENGTH: IN (CM)	CASE LOT
48144	Jumbo black plastic handle, rounded tip, hollow ground blade	4 $\frac{7}{8}$ (12.4)	9 $\frac{7}{8}$ (25.1)	12
48148	Jumbo riveted wood handle, rounded tip, hollow ground blade	5 (12.7)	9 $\frac{7}{8}$ (25.1)	12
48147	Riveted wood handle, rounded tip, hollow ground blade	4 $\frac{1}{8}$ (10.5)	8 $\frac{5}{8}$ (21.1)	24
48143	Plastic black textured handle, hollow ground blade, dishwasher safe	4 $\frac{3}{4}$ (12.1)	8 $\frac{3}{4}$ (22.3)	24
48130	Queen Anne™ well-balanced stainless steel hollow handle	5 (12.7)	9 $\frac{1}{8}$ (23)	12
48142	Laminated wood handle, pointed tip, hollow ground blade	4 (10.2)	8 $\frac{5}{8}$ (21.9)	12
48140	Wood handle, hollow ground blade	4 $\frac{3}{8}$ (11.2)	8 $\frac{5}{8}$ (21.1)	24
48141	Wood handle, pointed-tip blade	4 $\frac{1}{8}$ (10.5)	8 $\frac{5}{8}$ (21.1)	24

Thornhill™ Flatware

- Traditional design
- Matte finish, heavyweight
- 18% chrome stainless steel



ITEM #	DESCRIPTION	LENGTH: IN (CM)	CASE LOT
48150	Teaspoon	6 (15.2)	1 dz
48151	Dessert spoon	7 (17.8)	1 dz
48153	Bouillon spoon	6 (15.2)	1 dz
48154	Iced tea spoon	7½ (19.4)	1 dz
48152	Serving spoon	8 (20.3)	1 dz
48162	Dinner fork	7¼ (18.4)	1 dz
48161	4-tine salad fork	6 (15.2)	1 dz
48160	Oyster/shrimp fork	5½ (14)	1 dz
48171	Dinner knife, solid handle	8½ (21.6)	1 dz

Queen Anne™ Flatware

- Traditional colonial design
- Satin-finished, heavyweight
- 18% chrome stainless steel



ITEM #	DESCRIPTION	LENGTH: IN (CM)	CASE LOT
48100	Teaspoon	6 (15.2)	1 dz
48101	Dessert spoon	7 (17.8)	1 dz
48102*	Bouillon spoon	6½ (15.6)	1 dz
48103	Iced tea spoon	7½ (19.1)	1 dz
48104	Serving spoon	8¾ (21.3)	1 dz
48110*	Dinner fork	8 (20.3)	1 dz
48112*	4-tine dinner fork	7½ (19.1)	1 dz
48114	4-tine salad fork	6¾ (16.8)	1 dz
48113	3-tine salad fork	6¾ (17.2)	1 dz
48115	Oyster/shrimp fork	5¾ (14.3)	1 dz
48116	Serving fork	8¾ (21.9)	1 dz
48122*	Dinner knife, solid flat handle	9 (22.9)	1 dz
48131	Dinner knife, hollow handle	9 (22.9)	1 dz
48133	Dinner knife, hollow handle	9¾ (23.8)	1 dz
48130	Steak knife, hollow handle	9¾ (23)	1 dz
48125	Butter knife, hollow handle	7 (17.8)	1 dz

*Not shown



TABLETOP ESSENTIALS

SHAKERS, HOLDERS, JARS, SERVERS, ETC.

Wire Serving Pieces

- Ramekin holder is 2½" (6.4 cm) in diameter (Item #533-06)
- WP9-06 is powder coated



ITEM #	DESCRIPTION	DIMENSIONS IN (CM)	CASE LOT
WP9-06**	Black round basket	9 x 2½ (22.9 x 6.4)	12
WB-8006	Chrome oval basket	7½ x 10½ (18.1 x 26.7)	12
WB-8006-06**	Black oval basket	7½ x 10½ (18.1 x 26.7)	12
WB-8007*	Chrome oval basket w/ ramekin holder	7½ x 10½ (18.1 x 26.7)	12
WB-8007-06***	Black oval basket w/ ramekin holder	7½ x 10½ (18.1 x 26.7)	12

*Accommodates ramekin 533-06 (not included) **hand wash only

Twister® Wire Cones

- Unique wire cones for fries, appetizers, and more



ITEM #	DESCRIPTION	CAPACITY: C (L)	DIMENSIONS: IN (CM)	CASE LOT
WC-6007-06**	Large wire cone, black	3½ (0.8)	7 x 8¼ (17.8 x 21)	12
WC-6009-06***	Large wire cone w/ramekin holder, black	3½ (0.8)	7 x 7⅞ (17.8 x 19)	12
WC-6009*	Large wire cone w/ramekin holder, chrome	3½ (0.8)	7 x 7⅞ (17.8 x 19)	12
WC-6004-06**	Medium wire cone, black	1¼ (0.3)	5¼ x 6 (13.3 x 15.2)	12
WC-6004	Medium wire cone, chrome	1¼ (0.3)	5¼ x 6 (13.3 x 15.2)	12

*Accommodates ramekin 533-06 shown above (not included) **hand wash only

Baskets

- Durable
- Dishwasher safe



ITEM #	DESCRIPTION	DIAMETER: IN (CM)	CASE LOT
TAN PLASTIC RATTAN			
47204	Oblong	9 x 3½ x 2 (22.9 x 8.9 x 5.1)	12
47205	Round	9 x 2¼ (22.9 x 7)	12
47206	Oval	9½ x 6½ x 3 (24.1 x 16.5 x 7.6)	12
BLACK VINYL WITH GOLD TRIM			
47208	Oval	9 x 6¼ x 2¾ (22.9 x 15.9 x 6)	12

Dripcut® Condiment Caddies and Jars



ITEM #	DESCRIPTION	CAPACITY: OZ (ML)	DIMENSIONS (DIA X H): IN (CM)	CASE LOT
528-13	Clear poly condiment jar and lid	8 (237)	3¼ x 3¾ (9.5 x 7.9)	12
528J-13	Clear poly condiment jar only	—	—	12
528T-13	Clear poly condiment lid only	—	—	12
527	Glass condiment jar and lid	6 (177.4)	3¼ x 3¾ (9.5 x 7.9)	12
527J	Glass condiment jar only	—	—	12
527T	Glass condiment lid only	—	—	12
529-13	Clear polycarbonate condiment spoon	—	5¼ (13.3)	12
WR-1010	Wire rack condiment caddy – holds three condiment jars	—	7¾ x 6¾ x 7¾ (18.7 x 16.8 x 18.1)	4
WR-1000	Wire rack condiment caddy – holds two salt & pepper shakers, steak sauce/ketchup, and sugar packets – with cardholder	—	8 x 6 x 5½ (20.3 x 15.2 x 14)	6
WR-1003	Wire rack condiment caddy – holds two salt & pepper shakers	—	4¾ x 2¾ x 6 (11.1 x 6 x 14)	12
WR-1023	Round wire condiment caddy – holds four 12 oz squeeze bottles and salt & pepper shakers	—	7 x 9¼ (17.8 x 23.5)	4
WR-1017	Wire rack condiment caddy – holds three 206-0 or 1206 servers	—	6¼ x 6¾ x 7¼ (15.9 x 15.6 x 18.4)	4

Dripcut Cruets



ITEM #	DESCRIPTION	CAPACITY: OZ (ML)	DIMENSIONS: IN (CM)	CASE LOT
68028	Square glass oil & vinegar cruets w/wire rack	5 oz (148)	5¾ x 2½ x 7¼ (14.6 X 6.7 X 18.4)	6
WR-1020	Wire rack condiment caddy – holds two cruets	—	5¾ x 2½ x 7¼ (14.6 X 6.7 X 18.4)	6
68020-0	Square glass oil & vinegar cruets set	5 oz (148)	2½ x 5¾ (5.4 X 14.9)	12

Condiment Jar Cover

- Mirror-finished stainless steel
- Features spoon slot for no-mess service
- Fits 6½ oz (192 ml) jar



ITEM #	DESCRIPTION	DIAMETER: IN (CM)	CASE LOT
47648	Condiment jar cover	3¾ (7.9)	48

Dripcut® Salt & Pepper Shakers



ITEM #	DESCRIPTION	CAPACITY OZ (ML)	DIMENSIONS (DIA x H): IN (CM)	CASE LOT	REPLACEMENT JAR	REPLACEMENT TOP
PLASTIC TOP CAFÉ						
312-02	Poly jar/red plastic top S&P shaker	2 (59)	1¼ x 3¼ (4.5 x 9.5)	72	—	102T-02
312-06	Poly jar/black plastic top S&P shaker	2 (59)	1¼ x 3¼ (4.5 x 9.5)	72	—	102T-06
313-02	Poly jar/red plastic top S&P shaker	3 (89)	2 x 4½ (5.1 x 11.8)	72	—	102T-02
313-06	Poly jar/black plastic top S&P shaker	3 (89)	2 x 4½ (5.1 x 11.8)	72	—	102T-06
PANELED FLIP TOP™ CAFÉ						
322-06	Poly jar/black plastic top S&P shaker	2 (59)	1¼ x 3¾ (4.5 x 9.2)	72	—	—
PANELED POLYCARBONATE JARS/STAINLESS STEEL MUSHROOM TOP						
402	Poly jar/stainless steel mushroom top S&P shaker	2 (59)	1¼ x 3¾ (4.5 x 9.5)	72	—	440T
403	Poly jar/stainless steel mushroom top S&P shaker	3 (89)	2 x 4¾ (5.1 x 12.1)	72	—	440T
PANELED POLYCARBONATE JARS/STAINLESS STEEL FLAT TOP						
302-0	Poly jar/stainless steel flat top S&P shaker	2 (59)	1¼ x 3½ (4.5 x 8.9)	72	—	320T
303-0	Poly jar/stainless steel flat top S&P shaker	3 (89)	2 x 4¾ (5.1 x 11.8)	72	—	320T
CONTINENTAL COLLECTION						
802-12	Glass jar/chrome top S&P shaker	2 (59)	1¼ x 3 (4.5 x 7.6)	12	802J-12	802T
802G-12	Glass jar/gold top S&P shaker	2 (59)	1¼ x 3 (4.5 x 7.6)	12	802J-12	802T6
710	Glass jar/chrome top S&P shaker	.5 (15)	1½ x 2 (4.1 x 5.1)	72	—	—
ELEGANCE COLLECTION						
1003	Glass jar/chrome top S&P shaker	1 (29.5)	1¼ x 4¾ (4.5 x 11.1)	24	—	—
PLASTIC TOP CAFÉ						
602-12	Glass jar/stainless steel top S&P shaker	2 (59)	1¼ x 3 (4.5 x 7.6)	12	802J-12	440T
NOSTALGIC						
202-12	Square glass jar/stainless steel top S&P shaker	2 (59)	1½ x 4¾ (4.1 x 10.5)	12	—	—
SMOOTH GLASS JAR/STAINLESS STEEL MUSHROOM TOP						
703	Smooth glass jar stainless steel top S&P shaker	3 (89)	1¼ x 4¾ (4.5 x 11.8)	24	703J	440T

Dripcut Cheese Shakers



ITEM #	DESCRIPTION	CAPACITY OZ (ML)	DIMENSIONS (DIA x H): IN (CM)	CASE LOT	REPLACEMENT JAR	REPLACEMENT TOP
674	Round perforated SS top w/swirl glass jar	6 (177.4)	2½ x 3¾ (6.4 x 9.2)	12	674J-12	674T
260	Round SS top w/polycarbonate jar	4 (118.3)	2½ x 3¾ (6.4 x 8.9)	12	260LJ	260T

Dripcut Sugar Pourers & Holders



ITEM #	DESCRIPTION	CAPACITY OZ (ML)	DIMENSIONS L x W x H: IN (CM)	CASE LOT	REPLACEMENT JAR	REPLACEMENT TOP
930	Continental chrome-plated top glass sugar pourer	12 (355)	3¾ x 2¾ x 5½ (8.6 x 6 x 13)	12	930J	930T
SC-1007-13	Plastic sugar caddy	—	3¾ x 2¾ x 2¾ (8.6 x 6.5 x 5.4)	12	—	—
WR-1024	Chrome-plated sugar caddy w/handles	—	5 x 2½ x 1½ (12.7 x 5.4 x 4.1)	12	—	—
WR-1009	Chrome-plated sugar caddy w/out handles	—	5 x 2½ x 1½ (12.7 x 5.4 x 4.1)	12	—	—
WR-1025	Round chrome-plated sugar caddy	—	2¾ x 4¾ (7 x 10.8)	12	—	—

Dripcut® Servers with Plastic Jars and Chrome-Plated Tops



- Polycarbonate is clear; polyethylene is white

ITEM #	DESCRIPTION	CAPACITY: OZ (ML)	DIMENSIONS (L X W X H): IN (CM)	CASE LOT	REPLACEMENT JAR	REPLACEMENT TOP
1206	Polycarbonate jar w/top	7 (207)	2¾ x 1½ x 4¼ (7 X 4.1 X 10.8)	12	1206LJ	206T
1212	Polycarbonate jar w/top	10 (296)	3½ x 1¾ x 5 (7.9 X 4.5 X 12.7)	12	1212LJ	206T
1214	Polycarbonate jar w/top	16 (473)	3½ x 1¾ x 5¾ (8.9 X 4.8 X 14.6)	12	1214LJ	214T
2710L	Polycarbonate jar w/top	10 (296)	3 x 1¾ x 4¾ (7.6 X 4.5 X 12.4)	12	2710LJ	206T

Dripcut Servers



- Servers with glass jars and chrome-plated tops

ITEM #	DESCRIPTION	CAPACITY: OZ (ML)	DIMENSIONS (L X W X H): IN (CM)	CASE LOT	REPLACEMENT JAR	REPLACEMENT TOP
206-0	Glass jar w/top	6 (177.4)	2¾ x 1¾ x 3¾ (7 X 4.5 X 9.5)	12	206J	206T
912	Continental™ collection glass jar w/top	12 (355)	2¾ x 1¾ x 4¾ (7 X 4.5 X 10.5)	12	930J	912T
214	Glass jar w/top	14 (414)	3½ x 2 x 5½ (8.9 X 5.1 X 14.9)	12	214J	214T

Dripcut Servers with Glass Jars and Plastic Tops



- To specify top color when ordering your Dripcut® server, add suffix (TT) to choose color (brown 01, red 02, white 05, black 06, yellow 08, almond 18, vista green 191)

ITEM #	DESCRIPTION	CAPACITY: OZ (ML)	DIMENSIONS (L X W X H): IN (CM)	CASE LOT	REPLACEMENT JAR	REPLACEMENT TOP
606-TT*	Glass jar w/top	6 (177.4)	2¾ x 1¾ x 4¾ (7 X 4.5 X 10.5)	12	206J	606T-TT
614-TT**	Glass jar w/top	14 (414)	3½ x 2 x 5½ (8.9 X 5.1 X 14.9)	12	214J	614T-TT

*Available in red, black, almond, and vista green **Available in brown, red, white, almond, and vista green



Servers with Plastic Jars and Plastic Tops



- To specify top color when ordering your Dripcut® server, add suffix (TT) to choose color (brown 01, red 02, white 05, black 06, yellow 08, almond 18, vista green 191)

ITEM #	DESCRIPTION	CAPACITY: OZ (ML)	DIMENSIONS (L X W X H): IN (CM)	CASE LOT	REPLACEMENT JAR	REPLACEMENT TOP
1606-TT*	Polycarbonate jar w/top	7 (207)	2¾ x 1¾ x 4¼ (7 X 4.5 X 10.8)	12	1206LJ	606T-TT
1412-TT*	Polycarbonate jar w/top	10 (296)	3½ x 1¾ x 5 (7.9 X 4.5 X 12.7)	12	1212LJ	606T-TT
1414-TT**	Polycarbonate jar w/top	16 (473)	3½ x 1¾ x 5¾ (8.9 X 4.8 X 14.6)	12	1214LJ	614T-TT

*Available in red, black, and almond **Available in brown, almond, red, and vista green



Dripcut “Cut-Off” Slide Imprinting



- Customize your servers with cut-off slides imprinted with syrup flavors
- When ordering slides, add the syrup color suffix after the slide number, for example: 206S-I03 for maple imprint
- Imprint designations: honey 01, maple 03, boysenberry 04, strawberry 05, raspberry 06, lime 08, blueberry 09, wildberry 10, blackberry 11, twinberry 18
- 2- to 4-week lead time
- 100-piece minimum per imprint

ITEM #	DESCRIPTION	CASE LOT
206S-I	Imprint slide for 6 oz server chrome-plated top	100
214S-I	Imprint slide for 14 oz server chrome-plated top	100
606S-I	Imprint slide for 6 oz server plastic top	100
614S-I	Imprint slide for 14 oz server plastic top	100



SPECIALTY SERVICE ITEMS

Dessert Service

- Mirror-finished stainless steel



Silverplate available for some items – see more at VOLLRATH.com.



ITEM #	SILVERPLATE ITEM #	DESCRIPTION	CAPACITY	DIMENSIONS IN (CM)	CASE LOT
48013	48313	Paneled sherbet dish with scalloped top	3½ oz (103 ml)	1½ (4.8) height	12
48015	48315	Paneled sherbet dish with scalloped top	5 oz (148 ml)	2¼ (5.7) height	12
46701	48301	Paneled sherbet dish with gadroon base	16 oz (473 ml)	3¾ (8.6) height	12
48003	48303	Sherbet bowl with gadroon top	3½ oz (103 ml)	2 x 3¾ (5.1 x 9.6) (h x dia)	12
46704	—	Dessert cup with paneled design	4 oz (118 ml)	1½ x 3¾ (4.1 x 9.3) (h x dia)	48
48060	—	Tulip sundae with gadroon base	6 oz (177 ml)	4¾ (12) height	12
T720DW	—	Hammered double-wall ice cream chiller	3 gal (3.8 L)	10¾ x 11¾ (29.5 x 27.3) (h x dia)	1
48023	—	Cake stand shipped knocked down	—	6¾ x 13 (16.8 x 33) (h x dia)	1
48083	—	Cake/pie server with stainless steel blade and riveted rosewood handle	—	10¾ (27) length	12

Seafood Service



ITEM #	DESCRIPTION	DIMENSIONS: IN (CM)	CASE LOT
46745	Oyster plate, 6 wells, mirror-finished stainless steel	10¾ diameter (26.3)	12
46735	Seafood shell, mirror-finished stainless steel	5 x 5½ x ¾ (12.7 x 14.0 x 1.6)	12
46746	Snail plate, six embosses, mirror-finished stainless steel	6¾ x 5¾ x ¾ (17.5 x 13.8 x 1.8)	24
46760	Snail tongs, mirror-finished stainless steel	6 (15.2) length	12
46763	Lobster/nut cracker, forged stainless steel	6¼ (15.9) length	12
46764	Lobster/nut cracker, polished chrome plated	6 (15.2) length	24

SUPREME SET – ORDER PARTS SEPARATELY			
46701	16 oz (473 ml) paneled bowl with gadroon base	5¾ (12.8) outside diameter	12
46704	4 oz (119 ml) paneled cup	3¾ (9.2) outside diameter	48
46706	Slotted ring	5¾ (13) outside diameter	12
46709	1-piece slotted ring and cup	5¾ (13) outside diameter	12

Butter Melters

- Same stand – flip one way for 46771, flip over for 46770



Replacement parts available.
See VOLLRATH.com.



ITEM #	DESCRIPTION	CAPACITY: OZ (ML)	HEIGHT: IN (CM)	CASE LOT
46770	Butter melter with pan, candle holder and candle, chrome-plated wire stand	5 (148)	5½ (14.3)	1
46771	Butter melter with cup, candle holder and candle, chrome-plated wire stand	3 (89)	5½ (14.3)	6
46776	Butter melter with pan, glass candle holder and candle, chrome-plated wire stand	3¼ (96)	5 (12.7)	12
46777	Butter melter, stainless steel with pouring spout and rosewood handle	4¼ (125.7)	3¾ (9.2)	1

Utility Servers

- Chrome-plated welded wire rack
- Stainless steel bowls
- 99615, 47633, and 47631: full sets include 1 rack and 3 bowls



ITEM #	DESCRIPTION	DIMENSIONS W x H: IN (CM)	CAPACITY OZ (ML)	CASE LOT
99615*	Server set	8 x 7¾ (20.3 x 18.7)	–	1
69260	Bowl only	3 x 1½ (7.6 x 4.7)	6 (177)	12
99262	Replacement cover – fits 69260 bowls	3" (7.6)	–	12
47633	Server set	8½ x 8¾ (21.6 x 22.2)	–	6
47601	Bowl only	3½ x 2½ (9 x 6.4)	10 (295)	12
47631	Server set	9½ x 8¾ (24.1 x 22.2)	–	6
47522	Bowl only	4¾ x 2¾ (10.4 x 5.5)	12 (355)	12

*Includes bowl covers

Three-Way Revolving Server

- Rack revolves for easy access
- 99637 includes three 10 oz (295 ml) stainless steel bowls
- Stainless steel base with convenient plastic carry handle
- Ladle shown: 52908



ITEM #	DESCRIPTION	DIMENSIONS W x H: IN (CM)	CAPACITY OZ (ML)	CASE LOT
99637	Server	8¼ x 5¼ (20.9 x 14.6)	–	1
99636	Bowl only	4 x 2½ (10 x 6.3)	10 (295)	12

Gravy Boats

- Mirror-finished stainless steel
- Gadroon-edge base
- All-welded construction



Silverplate available for some items – see more at VOLLRATH.com.



ITEM #	SILVERPLATE ITEM #	DESCRIPTION	CAPACITY OZ (ML)	CASE LOT
47573	48373	Gravy boat	3 (89)	12
47575	48375	Gravy boat	5 (148)	12
47578	48378	Gravy boat	8 (236)	12

Serving Bowls



- Dishwasher-safe, impact-resistant melamine construction
- In compliance with FDA standards
- Ideal for salad, chips, and condiments
- Heat resistant up to 187°F (86°C)

ITEM #	DESCRIPTION	CAPACITY OZ (ML)	DIMENSIONS IN (CM)	CASE LOT
52860	Birchwood	12 (354)	5¾ (14.6)	12
52861	Black	12 (354)	5¾ (14.6)	12
52866	Birchwood	14 (413)	6 (15.2)	12
52867	Black	14 (413)	6 (15.2)	12
52869	Birchwood	34 (1005)	8 (20.3)	12
52870	Black	34 (1005)	8 (20.3)	12

Plastic Tip Trays

1000-06



- Attractive scratch-resistant material



1000-96

ITEM #	DESCRIPTION	DIMENSIONS IN (CM)	CASE LOT
86280	Plain black tray	4 x 6 (10.2 x 15.2)	36
86282	Plain black tray	5 x 7 (12.7 x 17.8)	36
1000-06	Plain black tray	6½ x 4½ (16.5 x 11.4)	36
1000-96	Thank You black tray	6½ x 4½ (16.5 x 11.4)	36

Counter Menu Holder



- Stainless steel
- Screw-on assembly
- Set includes brackets
- 15½" (39.4 cm)

ITEM #	DIMENSIONS: IN (CM)	CASE LOT
46797	15½ x 4 (39.4 x 10.2) length x height above counter	12

Condiment and Card Holder



- Stainless steel
- Sanitary rounded corners

ITEM #	DIMENSIONS (L X W X H): IN (CM)	CASE LOT
46796	2½ x 1½ x 1½ (6.4 x 3.8 x 3.8)	24

Card and Menu Holders



- Stainless steel
- 46795: Weighted cast base adds stability

ITEM #	DIMENSIONS: IN (CM)	CASE LOT
46795	1½ (2.9) 1½ (3.8) length x height above counter	36
46794	2¼ (5.7) 1¾ (4.4) length x height above counter	60

Check Spindle



ITEM #	DESCRIPTION	DIMENSIONS (D X H): IN (CM)	CASE LOT
2721	Check spindle	3 x 6 (7.6 x 15.2)	12

Check Holders



- Brushed aluminum
- Patent-pending channel lock design keeps checks organized



ITEM #	DESCRIPTION	DIMENSIONS: IN (CM)	CASE LOT
2518	Check holder	18 x 2 (45.7 x 5.1)	2
2524	Check holder	24 x 2 (61 x 5.1)	2
2536	Check holder	36 x 2 (91.4 x 5.1)	2
2548	Check holder	48 x 2 (121.9 x 5.1)	2

Table Joiner



Top view

- Plated steel
- Adjusts from 24" to 42" (61 to 106 cm)
- Two-piece construction
- For square or rectangular tables

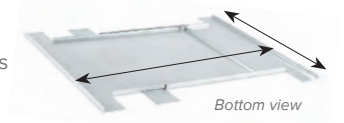

Bottom view

ITEM #	DESCRIPTION	CASE LOT
97299	Table joiner	3

TRAYS

Cork-Lined Laminated Serving Trays and Liners

- Multi-layer construction with molded-in cork surface
- Helps prevent slipping even when wet
- Liner will not peel or warp for longer life
- Self-adhesive non-skid cork liners for trays without cork surface
- Tray color: brown
- Hand-washing recommended



86338

ITEM #	DESCRIPTION	DIMENSIONS (L x W): IN (CM)	CASE LOT
CORK-LINED LAMINATED SERVING TRAYS			
86326	Rectangular tray	12 x 16 (30.5 x 40.6)	12
86328	Rectangular tray	14 x 18 (35.6 x 45.7)	12
86330	Rectangular tray	15 x 20 (38.1 x 50.8)	12
86331	Rectangular tray	16 x 22 (40.6 x 55.9)	12
86333	Oval tray	20 x 25 (50.8 x 63.5)	6
86334	Oval tray	23 x 28 (58.4 x 71.1)	6
86336	Round tray	11 (27.9) dia	12
86339	Round tray	14 (35.6) dia	12
86341	Round tray	16 (40.6) dia	12
86338	Beer tray, round	12½ (31.8) dia	12
ROUND CORK LINERS			
86350	Fits 11" dia (27.9 cm) trays	9½ (23.2) dia	12
86351	Fits 12" dia (30.5 cm) trays	11 (27.9) dia	12
86352	Fits 14" dia (35.6 cm) trays	12½ (30.8) dia	12
86353	Fits 16" dia (40.6 cm) trays	12½ (32.9) dia	12
OVAL CORK LINERS			
86360	Fits 20" x 25" (50.8 x 63.5 cm) trays	16¼ x 21 (41.3 x 53.3)	12
86361	Fits 23" x 28" (58.4 x 71.1 cm) trays	19½ x 23½ (48.6 x 60)	12

Tuf Glas™ Fiberglass Trays



- Low-profile design allows larger and low-profile plates to hang over the edge without tipping
- Rubber liner is permanently bonded to the tray
- Heavy-duty construction eliminates warping
- Stain and odor resistant
- 5-year warranty

ITEM #	DESCRIPTION	DIAMETER: IN (CM)	CASE LOT
2700L-01	Brown tray	27 (68.6)	6
2700L-06	Black tray	27 (68.6)	6

Traex® Non-Skid Trays



- Anti-skid surface resists glassware slippage even when wet
- Anti-skid liner is molded right to the tray; custom color combinations available
- Lifetime warranty



ITEM #	DESCRIPTION	DIAMETER: IN (CM)	CASE LOT
1474-0606	Black tray	14 (35.6)	12
1476-0606	Black tray	16 (40.6)	12

Traex Talker™ Trays



- Increase your sales with a POP sign that stays securely in place without disturbing the items on the tray
- U.S. Patent #6,843,373
- Sign holder is 4" x 6"



ITEM #	DESCRIPTION	DIAMETER: IN (CM)	CASE LOT
1489-0606	Black tray w/sign holder	14 (35.6)	12

Anti-Skid Mat Tray Accessories



ITEM #	DESCRIPTION	DIAMETER: IN (CM)	CASE LOT
1420-01	Chocolate anti-skid mat	12½ (31.8) dia	12
1420-06*	Black anti-skid mat	12½ (31.8) dia	12
1620-01	Chocolate anti-skid mat	14½ (36.8) dia	12
1620-06	Black anti-skid mat	14½ (36.8) dia	12
1612	Chocolate anti-skid mat	16½ x 12½ (41 X 31.8)	12
1612-06	Black anti-skid mat	16½ x 12½ (41 X 31.8)	12

*Minimum order quantity 240

Stainless Steel Institutional Ware

- Mirror-finished stainless steel

ITEM #	DESCRIPTION	CAPACITY: OZ (ML)	DIMENSIONS: IN (CM)	CASE LOT
47252	Six-compartment tray with stacking lugs	—	15½ l x 11½ w x ¾ h (39.4 x 29.5 x 1.9)	24
47536	Soup bowl	16.3 (482)	6 dia x 1¼ h (15.2 x 4.5)	12
47555	Drink or soup cup	9 (266)	3½ dia x 2½ h (8.9 x 5.6)	12
47556	Drink or soup cup	11 (325)	3½ dia x 2¾ h (8.9 x 6)	12
68520*	Tumbler	12 (354)	3½ x 2½ x 4¾ (8 x 5.2 x 11.5) (top dia x bottom dia x h)	12

*68520 tumbler only is made in USA



47252

47536



47555



68520



Polypropylene Fast Food Trays

- Thick reinforced rim with corner ribs add impact strength – reducing breakage and minimizing warping
- Four stacking lugs speed drying and prevent sticking
- Semi-gloss, weave-grain textured finish provides a reduced-slip surface
- Recyclable to reduce landfill waste
- Heat resistant up to 187°F (86°C)



Personalize your fast food trays with custom silkscreen imprints at VOLLRATH.com.



COLOR	ITEM #	DIMENSIONS IN (CM)	CASE LOT
Red	86100	10 x 14 (25.4 x 35.6)	24
Brown	86101	10 x 14 (25.4 x 35.6)	24
Burgundy	86103	10 x 14 (25.4 x 35.6)	24
Orange	86104	10 x 14 (25.4 x 35.6)	24
Gray	86105	10 x 14 (25.4 x 35.6)	24
Almond	86106	10 x 14 (25.4 x 35.6)	24
Royal blue	86107	10 x 14 (25.4 x 35.6)	24
Black	86108	10 x 14 (25.4 x 35.6)	24
Teal	86109	10 x 14 (25.4 x 35.6)	24

ITEM #	DIMENSIONS IN (CM)	CASE LOT
86110	12 x 16 (30.5 x 40.6)	24
86111	12 x 16 (30.5 x 40.6)	24
86113	12 x 16 (30.5 x 40.6)	24
86114	12 x 16 (30.5 x 40.6)	24
86115	12 x 16 (30.5 x 40.6)	24
86116	12 x 16 (30.5 x 40.6)	24
86117	12 x 16 (30.5 x 40.6)	24
86118	12 x 16 (30.5 x 40.6)	24
86119	12 x 16 (30.5 x 40.6)	24

ITEM #	DIMENSIONS IN (CM)	CASE LOT
86120	14 x 18 (35.6 x 45.7)	12
86121	14 x 18 (35.6 x 45.7)	12
86123	14 x 18 (35.6 x 45.7)	12
86124	14 x 18 (35.6 x 45.7)	12
86125	14 x 18 (35.6 x 45.7)	12
86126	14 x 18 (35.6 x 45.7)	12
86127	14 x 18 (35.6 x 45.7)	12
86128	14 x 18 (35.6 x 45.7)	12
86129	14 x 18 (35.6 x 45.7)	12

Traex® Premium Fast Food Trays

- Easy to clean with built-in handles for comfortable and controlled handling
- Dishwasher safe
- Stain and odor resistant
- Stackable and approved for up to 180°F (82°C) for 30 minutes
- Add color suffix to base item number to indicate color selection (brown -01, red -02, orange -03, blue -04, black -06, burgundy -21, gray -31, beige -32, teal -33, royal blue -44, vista green -191)



ITEM #	DESCRIPTION	DIMENSIONS: IN (CM)	CASE LOT
1014-XX	Fast food tray	14 ¹⁵ / ₁₆ x 10 ⁵ / ₁₆ (36.4 x 27)	24
1216-XX	Fast food tray	17 ³ / ₁₆ x 12 ¹ / ₁₆ (43.6 x 30.8)	24
1418-XX	Fast food tray	18 ¹ / ₂ x 13 ³ / ₈ (47 x 35.2)	12
1217-XX	Fast food tray	17 x 12 (43.2 x 30.5)	24

Traex School Compartment Trays

- Lightweight
- Economically priced
- Heat resistant to 180°F (82.2°C)
- Add color suffix to base item number to indicate color selection (red -02, blue -04, tan -09, bright blue -104, bright green -119, bright yellow -138)*



ITEM #	DESCRIPTION	DIMENSIONS: IN (CM)	CASE LOT
2614-XX*	Left hand tray, polypropylene	13 ³ / ₈ x 9 ³ / ₄ (34.6 x 24.8)	24
2015-XX	Right hand tray, polypropylene	14 ³ / ₈ x 9 ³ / ₈ (36.5 x 25.1)	24
2615-XX	Right hand tray, ABS	14 ¹ / ₂ x 10 (36.9 x 25.4)	24

*2614-XX available only in red -02 and blue -04

Symbol Signs

- High-quality image signs have pressure-sensitive adhesive for easy mounting



ITEM #	DESCRIPTION	DIMENSIONS: IN (CM)	CASE LOT
FOREIGN LANGUAGE SYMBOL SIGN			
4531	Los Empleados Deben Lavarse Las Manos Antes De Regresar Al Trabajo (Employees Must Wash Hands Before Returning to Work)	3 x 9 (7.6 x 22.9)	1
4566	Men/Caballeros	3 x 9 (7.6 x 22.9)	1
4567	Women/Damas	3 x 9 (7.6 x 22.9)	1
4589	No Fumar/No Smoking	3 x 9 (7.6 x 22.9)	1
TABLETOP TENT SIGN			
4135	Reserved – Screen-printed plastic signs, message on both sides	3 x 9 (7.6 x 22.9)	1
BRaille SYMBOL SIGN			
5630	Women/Accessible	6 x 9 (15.2 x 22.9)	1
5631	Men/Accessible	6 x 9 (15.2 x 22.9)	1
5632	Accessible	6 x 9 (15.2 x 22.9)	1
5633	Restroom	6 x 9 (15.2 x 22.9)	1
5634	Women	6 x 9 (15.2 x 22.9)	1
5635	Men	6 x 9 (15.2 x 22.9)	1
5638	No Smoking	6 x 9 (15.2 x 22.9)	1
CONTEMPORARY ENGLISH SYMBOL SIGN			
4504	Hand Wash Only	3 x 9 (7.6 x 22.9)	1
4505	Private	3 x 9 (7.6 x 22.9)	1
4506	Employees Only	3 x 9 (7.6 x 22.9)	1
4508	No Exit	3 x 9 (7.6 x 22.9)	1
4513	No Smoking	3 x 9 (7.6 x 22.9)	1
4515	Men	3 x 9 (7.6 x 22.9)	1
4516	Women	3 x 9 (7.6 x 22.9)	1
4517	Restrooms	3 x 9 (7.6 x 22.9)	1
4519	Sanitize	3 x 9 (7.6 x 22.9)	1
4520	No Checks Please	3 x 9 (7.6 x 22.9)	1
4521	Thank You For Not Smoking	3 x 9 (7.6 x 22.9)	1
4522	Rinse	3 x 9 (7.6 x 22.9)	1
4523	No Pets/Shoes, Shirt Required	3 x 9 (7.6 x 22.9)	1
4524	This is a Smoke-Free Restaurant	3 x 9 (7.6 x 22.9)	1
4525	Restrooms For Customer Use Only	3 x 9 (7.6 x 22.9)	1
4526	Wash	3 x 9 (7.6 x 22.9)	1
4530	Employees Must Wash Hands Before Returning to Work	3 x 9 (7.6 x 22.9)	1
4532	Not Responsible For Lost Or Stolen Articles	3 x 9 (7.6 x 22.9)	1
4544	Caution/Watch Your Step	3 x 9 (7.6 x 22.9)	1
SYMBOL SIGN			
5613	No Smoking	6 x 9 (15.2 x 22.9)	1
5617	Restrooms	6 x 9 (15.2 x 22.9)	1
5609	Exit	6 x 9 (15.2 x 22.9)	1
5618	Fire Extinguisher	6 x 9 (15.2 x 22.9)	1
5643	No Smoking Area	6 x 9 (15.2 x 22.9)	1
5644	Accessible	6 x 9 (15.2 x 22.9)	1



5644

5609

5618

5643



WAREWASHING & HANDLING

An efficient, clean front of house requires an organized back of house. Vollrath's durable and customizable collection of warewashing racks, bus boxes, and carts offers many cost-effective solutions to keep your process flowing smoothly.



**THE
INDUSTRY'S
LARGEST
SELECTION
OF RACKS FOR
GLASSWARE,
DINNERWARE,
AND FLATWARE**

A complete selection of racks and accessories that provide outstanding strength, adaptability; versatility, and durability. Unbeatable value in today's foodservice operations.



How to Shop

WAREWASHING & HANDLING



Signature Warewashing

With a complete selection of sturdy, light-weight racks and accessories, our Signature warewashing line offers outstanding durability and versatility. Its unique open design promotes better washing and rinsing as well as faster drying.

Pages 255-262

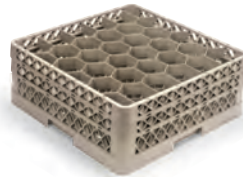

Traex® Warewashing

The Traex warewashing system is flexible enough to accommodate almost all glassware, dinnerware, and smallware. Whether the open-wall design or the all-new, closed-wall style, each system allows for top-to-bottom and side-to-side washing and drying while delivering outstanding strength and durability.

Pages 263-274



Utility Carts

Keep your staff and your dinnerware, glassware, and flatware moving quickly with sturdy utility carts. Our selection includes standard, bussing, and multi-purpose carts.

Pages 289-293



FULL-SIZE RACKS

Pages 257-260



OPEN-WALL FULL-SIZE RACKS

Pages 267-272



HALF-SIZE RACKS

Pages 261-262



NEW CLOSED-WALL FULL-SIZE RACKS

Pages 268-271



FLATWARE RACKS & ACCESSORIES

Pages 275-277



HALF-SIZE RACKS

Page 274



BUS BOXES & COVERS

Page 278



FLATWARE RACKS & ACCESSORIES

Pages 281-282



RACK DOLLIES

Pages 279 & 286



BUS BOXES & COVERS

Page 283



COMPONENT PARTS

Page 280



DISH CADDIES, DOLLIES & COVERS

Pages 284-286



COMPONENT PARTS

Pages 287-288

How to Order SIGNATURE WAREWASHING RACKS



Step 1 CHOOSE THE TYPE OF RACK YOU NEED



FULL-SIZE RACKS

Pages 257-260



HALF-SIZE RACKS

Pages 261-262

Step 2 MEASURE

- Take the physical glass, mug, or stemware you need to accommodate and flip to page 265. The chart will determine the appropriate rack height as well as the number of compartments to fulfill your needs.
- Visit VOLLRATH.com for an online Signature rack measuring tool.



Visit VOLLRATH.com/warewashingconfigurator for an online warewashing guide.

Step 3 SELECT YOUR BASIC RACK COLOR

- Select the color of the basic rack and add the sixth digit to the basic rack number
- Full-size racks are available in all eight colors
- Half-size racks are available in light green and cocoa only
- Not all racks come in all colors; see individual pages for color offerings



Step 4 CONSIDER A COLOR-CODED TOP RISER

- To indicate the style of glass/stemware or the facility where the rack is used, you can color-code the top riser of Vollrath compartment racks. Just code the seventh digit of the item number with the desired color number listed at the bottom of the previous page. It's a perfect system for resorts, hotels, clubs, and institutions. Optional methods of color coding are available upon request.

<i>Example</i>	5 2 7 1 6	+3	+6	= 5271636
<i>Red rack is code 3 Grey top is code 6</i>	<i>Five-digit item number for basic 36-compartment X-Tall Rack</i>	<i>Red base</i>	<i>Grey top riser</i>	<i>Seven- digit code</i>

Step 5 STANDARD & CUSTOM IMPRINTING

- STANDARD IMPRINTING:** Vollrath gives you the option of rack identification by imprinting the glass symbol and name on each rack. Letters will appear in white ink only, 1/2" high. To order symbol imprinting, simply identify the symbol name after the seven-digit rack model number, as in the example below.

Example:
52711-11 Beer
52715-66 White Wine

Please note: The number to the left represents the rack ordered, the color selected, the top riser color, and the symbol imprinting. If both a custom logo and a glass symbol are specified, the logo will appear on one side and the glass symbol on the other. Contact your DSM for a custom form to submit with your order.

- CUSTOM IMPRINTING:** You can have your racks personalized with your company name, logo, or any other text. Maximum size of imprint is 1" H x 2.5" L in white ink only. Camera-ready art required. There is a one-time charge for preparation of the die plus a nominal charge per rack personalized. Allow 5 days for a die to be produced once artwork is approved.

Note: Racks are made to order and cannot be returned

	BEER		BEVERAGE		BRANDY
	BURGUNDER		CHAMPAGNE		COCKTAIL
	COFFEE MUG		COLLINS		CUP
	GOBLET		HI-BALL		ICED TEA
	JUICE		MARGARITA		MARTINI
	OLD FASHIONED		RED WINE		ROCKS
	TULIP CHAMPAGNE		WATER		WHITE WINE
	WINE	AGUA PARFAIT CORDIAL DINNER STEIN B&B SALAD SODA SOUP FLATWARE			

*Also available in Spanish.
Additional symbols available. Contact your Vollrath representative.*

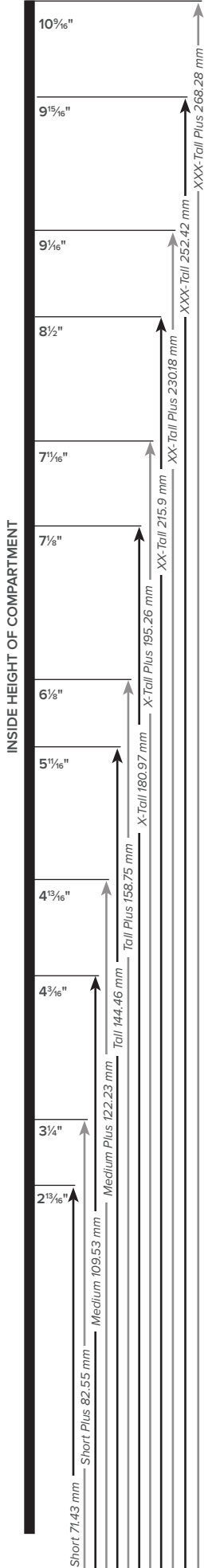

Signature Full-Size Rack Sizing Template

- DETERMINING RACK HEIGHT: Place the base of glass or mug piece on bottom edge of this page. Or remove page and stand it on edge on a flat surface next to your glass or mug. Then select rack type with appropriate number of risers by referring to the crossbar immediately above your glassware piece on the chart.
- DETERMINING NUMBER OF COMPARTMENTS: Place an inverted glass on the diagram. Looking directly downward on the glass, make sure the greatest diameter of the glass or mug is within the appropriate square. When measuring cups or mugs, be sure to allow for extension of handles. All Vollrath compartment racks have dividers of equal dimension top and bottom to protect glassware during the vigorous wash cycle.

Full-Size Compartment Racks

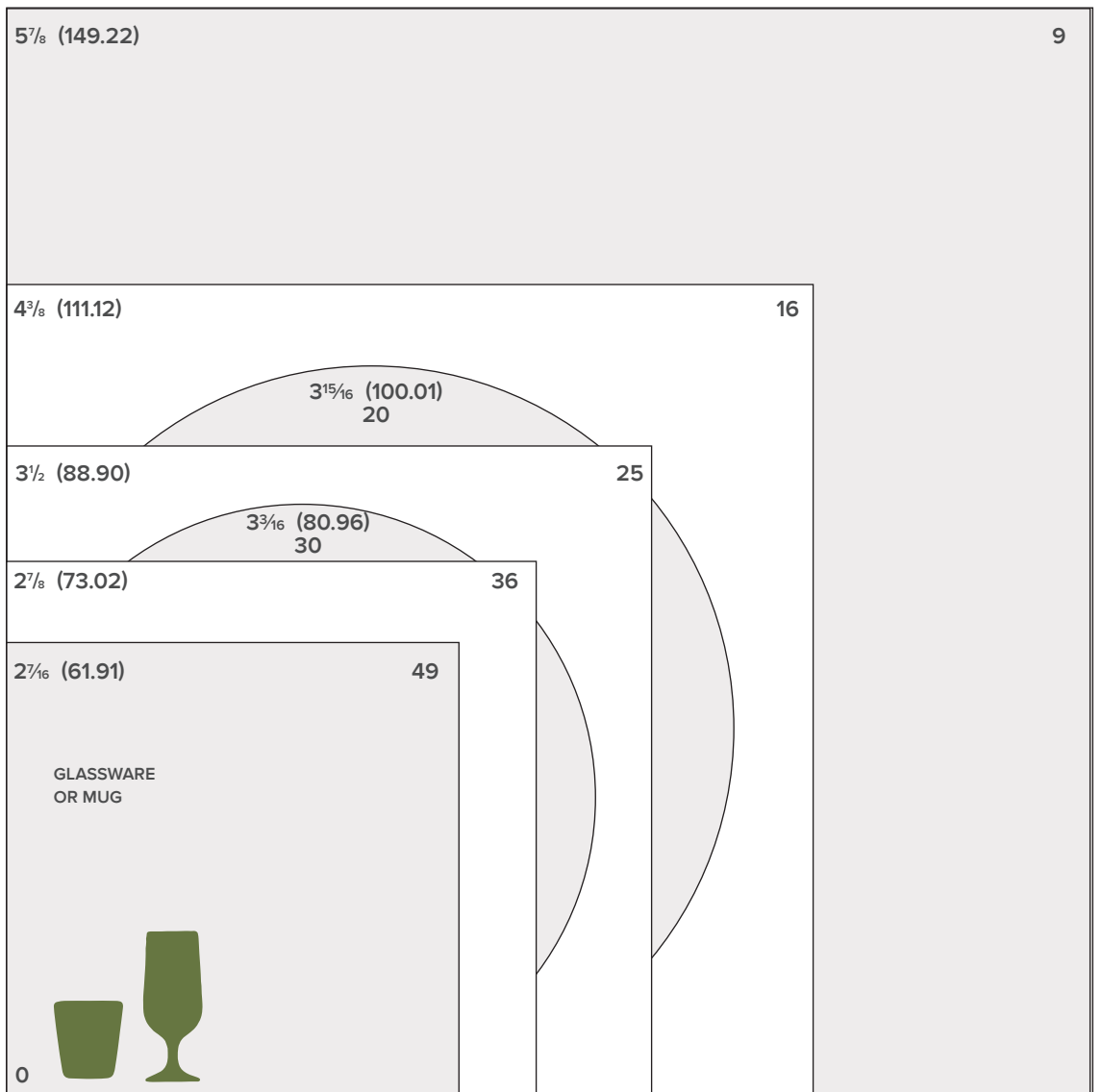

* Because of height limitations, XXXX-Tall cannot be shown on this chart.
XXXX-Tall is 11 1/8" (288.92 mm)

COMPARTMENT WIDTH: IN (MM)

SIGNATURE FULL-SIZE COMPARTMENT RACKS



Signature Warewashing Racks

- A complete selection of racks and accessories that provide outstanding strength, adaptability, versatility, and durability. An unbeatable value in today's foodservice operations.



Signature peg corner design provides secure stacking with Vollrath and most competitors' racks.



Signature open design promotes better washing and rinsing and faster drying.



Signature four-way tracking on all full-size racks allows for fast dish machine loading in either direction.



Signature unique rack design uses stainless screws and a variety of interchangeable risers and dividers for hundreds of custom configurations.



Signature rack imprinting adds identification. Choose stock or custom imprint.

Lemon Drop™ 20- and 30-Compartment Racks

- Provide expanded capacity over the traditional rack options
- Incorporate all the features expected from the finest line of warewashing racks
- Strategically located compartment dividers offer premium glass protection while providing the open design – ideal for maximizing cleaning performance
- Lemon Drop design patent is # D650,541

Vollrath Lemon Drop Design



discover SAVINGS		
- Less Water	TOTAL SAVINGS: \$1,431+* from increased capacity	Time & Labor = \$1,095
- Less Energy		Water = \$56
- Fewer Chemicals		Chemicals = \$192
- Less Waste		Breakage = \$88

*Based on industry data for 20-compartment rack

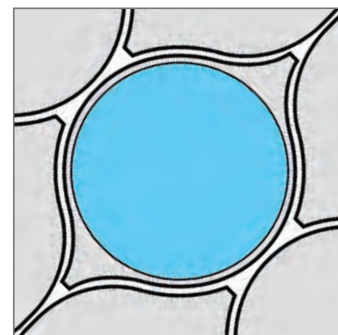

Signature Full-Size Compartment Racks

- Open design promotes thorough washing action, complete rinsing, rapid drying, and quick glass cooling for spot-free glassware
- Individual compartments help prevent chipping and breakage
- Ideal for storage; provide excellent protection and minimize costly replacement
- Outside dimensions: 19³/₄" x 19³/₄" (50 x 50 cm)
- See page 255 for standard and custom imprinting



52763
9-COMPARTMENT
5⁷/₈" (14.9 cm) sq. compartment
8⁵/₁₆" (21.1 cm) diagonal



52720
16-COMPARTMENT
4³/₈" (11.1 cm) sq. compartment
6³/₁₆" (15.7 cm) diagonal



52757
20-COMPARTMENT
3¹⁵/₁₆" (10 cm) diameter
Lemon Drop™



52712
25-COMPARTMENT
3¹/₂" (8.9 cm) sq. compartment
4¹/₁₆" (12.5 cm) diagonal



52812
30-COMPARTMENT
3³/₁₆" (8.1 cm) diameter
Lemon Drop



52715
36-COMPARTMENT
2⁷/₈" (7.3 cm) sq. compartment
4¹/₄" (10.3 cm) diagonal



52784
49-COMPARTMENT
2⁷/₁₆" (6.2 cm) sq. compartment
3³/₁₆" (8.7 cm) diagonal

9-COMP	16-COMP	20-COMP*	25-COMP	30-COMP*	36-COMP	49-COMP	DESCRIPTION	OVERALL HEIGHT IN (CM)	INSIDE HEIGHT IN (CM)	CASE LOT
52726	52694	52691	52684	52790	52689	52699	Short	4 ¹ / ₈ (10.5)	2 ¹ / ₁₆ (7.1)	6
52760	52766	52692	52772	52811	52778	52784	Short plus	4 ⁷ / ₈ (12.4)	3 ¹ / ₄ (8.3)	5
52727	52718	52693	52710	52812	52714	52722	Medium	5 ⁵ / ₈ (14.3)	4 ⁵ / ₁₆ (11)	4
52761	52767	52702	52773	52813	52779	52785	Medium plus	6 ³ / ₈ (16.2)	4 ¹ / ₁₆ (12.2)	4
52728	52719	52703	52711	52816	52715	52723	Tall	7 (17.8)	5 ⁵ / ₁₆ (14.4)	3
52762	52768	52704	52774	52817	52780	52786	Tall plus	7 ¹ / ₄ (19.7)	6 ¹ / ₄ (15.9)	3
52730	52720	52706	52712	52832	52716	52724	X-tall	8 ¹ / ₂ (21.6)	7 ⁷ / ₁₆ (18.1)	3
52763	52769	52707	52775	52844	52781	52787	X-tall plus	9 ¹ / ₄ (23.5)	7 ⁷ / ₁₆ (19.5)	2
52729	52721	52708	52713	52845	52717	52725	XX-tall	9 ⁷ / ₈ (25.1)	8 ¹ / ₁₆ (21.6)	2
52764	52770	52709	52776	52846	52782	52788	XX-tall plus	10 ¹ / ₁₆ (26.8)	9 ¹ / ₁₆ (23)	2
52731	52732	52754	52733	52847	52734	52735	XXX-tall	11 ¹ / ₁₆ (28.7)	9 ⁹ / ₁₆ (25.2)	2
52765	52771	52755	52777	52848	52783	52789	XXX-tall plus	12 ¹ / ₈ (30.8)	10 ³ / ₁₆ (26.8)	2
52736	52737	52757	52738	52849	52739	52740	XXXX-tall	12 ³ / ₄ (32.4)	11 ¹ / ₈ (28.9)	2

*Lemon Drop design – see page 257 for details, Patent # D650,541

COLORS



1
light green



2
cocoa



3
red



4
light blue



5
gold



6
grey



7
royal blue



9
burgundy

*Racks are made to order and cannot be returned.

Signature Full-Size Cup Racks

- Molded tilt bar (¼") prevents water from pooling in bottom of cup
- Extra-high molded compartments prevent chipping and breakage
- Outside dimensions: 19¾" x 19¾" (50 x 50 cm)

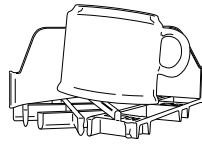

Tilt Bar



52676
16-COMPARTMENT
4⅞" (11 cm) sq
Diagonal 6⅞" (15.6 cm)



52675
20-COMPARTMENT
3⅞" (8.7 cm) x 4⅞" (13.7 cm)
Diagonal 5⅝" (13.7 cm)

16-COMP	20-COMP	OVERALL HEIGHT IN (CM)	INSIDE HEIGHT IN (CM)	CASE LOT
52674	—	4⅞ (10.5)	2¾ (7)	6
52676	—	5⅞ (14.1)	4⅞ (10.5)	4
—	52675	4⅞ (10.5)	2⅞ (6.8)	6
—	52677	5½ (14)	4⅞ (10.5)	4

RACK COLORS



Signature Full-Size Flatware Racks

- Tight mesh bottom grid prevents flatware from falling through
- Outside dimensions: 19¾" x 19¾" (50 x 50 cm)



52671

ITEM #	INSIDE COMPARTMENT: IN (CM)	OVERALL HEIGHT: IN (CM)	INSIDE HEIGHT: IN (CM)	CASE LOT
52671	18⅞ x 18⅞ (45.9 x 45.9)	4⅞ (10.5)	2⅞ (6.7)	6

COLORS



Signature Full-Size Open Racks

- Open racks are designed for uniquely shaped or oversized dishes, utensils, and cookware
- Outside dimensions: 19¾" x 19¾" (50 x 50 cm)



52680

ITEM #	DESCRIPTION	OVERALL HEIGHT: IN (CM)	INSIDE HEIGHT: IN (CM)	CASE LOT
52670	Short	4⅞ (10.5)	2⅞ (7.1)	6
52696	Extended	4⅞ (12.4)	3¼ (8.3)	5
52680	Medium	5½ (14)	4⅞ (10.5)	4
52681	Tall	6⅞ (17.5)	5½ (14)	3
52682	X-tall	8⅞ (20.8)	6⅞ (17.3)	3
52683	XX-tall	9⅞ (24.3)	8¼ (21)	2

COLORS

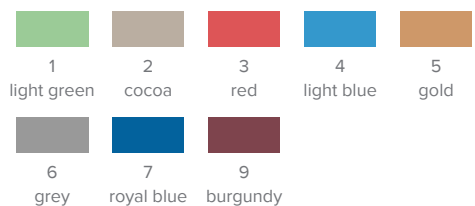

*Racks are made to order and cannot be returned.

Signature Full-Size Plate Racks

- Holds plates and trays upright for the ideal cleaning angle; reduces chipping and breakage
- Signature extended-height racks have 3" tall pegs
- Outside dimensions: 19¾" x 19¾" (50 x 50 cm)



ITEM #	DESCRIPTION	OVERALL HEIGHT: (CM)	INSIDE HEIGHT: (CM)	PEG HEIGHT: IN (CM)	ROWS	PEG SPACING: IN (CM)	CASE LOT
52672	Standard height	3¼ (9.5)	2¾ (7)	2⅞ (6.2)	8 x 8	1⅞ (4)	6
52695	Extended height	4⅞ (12.4)	3¼ (8.3)	3⅝ (8.0)	8 x 8	1⅞ (4)	5

RACK COLORS



Signature Tray & Pan Rack

- Ideal for washing trays
- Has a stainless steel reinforced channel to support fiberglass and laminated trays or metal items
- Outside dimensions: 19¾" x 19¾" (50 x 50 cm)



ITEM #	DESCRIPTION	OVERALL HEIGHT: IN (CM)	INSIDE HEIGHT: IN (CM)	CASE LOT
52678	Open-end	3¼ (9.5)	2¾ (7)	6

COLORS



Signature Insulated Tray and Steam Table Pan Rack

- Designed to wash insulated foodservice trays and 2½" deep (6.5 cm) steam table pans
- 52669 open-end rack with steel channel supports heavy oversized trays and steam table pans
- Outside dimensions: 19¾" x 19¾" (50 x 50 cm)



ITEM #	DESCRIPTION	OVERALL HEIGHT: (CM)	INSIDE HEIGHT: (CM)	SPACING: IN (CM)	CASE LOT
52669	Tray rack with chrome-plated insert – standard height open end with stainless channel, insert is free-floating	4½ (11.4)	4½ (11.4)	3 (7.6)	1
52665	Insert only – chrome-plated	4½ (11.4)	4½ (11.4)	—	1

COLORS



Signature Sheet Pan Racks

- Holds three full-size sheet pans
- Designed to fit standard-height openings for all conveyor-type dishwashers
- 52664 rack stacks with wire insert in place
- Outside dimensions: 19¾" x 19¾" (50 x 50 cm)



ITEM #	DESCRIPTION	OVERALL HEIGHT: (CM)	INSIDE HEIGHT: (CM)	SPACING: (CM)	CASE LOT
52664	Open-end rack with chrome-plated insert	4⅞ (12.4)	3¼ (8.3)	2¼ (5.7)	1

COLORS



*Racks are made to order and cannot be returned.

SIGNATURE HALF-SIZE COMPARTMENT RACKS



Signature Specialty Half-Size Rack

- Ideal for storage and washing salt and pepper shakers, bud vases, shot glasses, and candle holders
- 32-compartment half-size rack is easy to store in the bar area or in setup stations
- Includes special corner compartment for washing shaker tops
- Outside dimensions: 10" x 19¾" (25.4 x 50.2 cm)

52819
32-COMPARTMENT
 2½" (5.2 cm) square compartment
 Diagonal 2¾" (6.9 cm)



ITEM #	DESCRIPTION	OVERALL HEIGHT: IN (CM)	INSIDE HEIGHT: IN (CM)	CASE LOT	COLORS
52815	Short	4½ (10.5)	2⅞ (7.3)	6	
52819	Medium	5⅞ (14.4)	4⅞ (11.6)	4	
52828	Tall	7⅞ (18.3)	6⅞ (15.4)	3	
52829	X-tall	8⅞ (22.5)	7⅞ (19.5)	3	
52834	XX-tall	10⅞ (26.4)	9⅞ (23.3)	2	

Signature Half-Size Cup Racks

- Molded 1" (2.5 cm) high divider keeps cups in place
- Eight-cup: 4⅜" x 4⅝" (11.1 x 11 x 16.5 cm) with 6" diagonal
- Ten-cup: 3⅞" x 4⅜" (8.7 x 11.1 x 14 cm) with 5½" diagonal
- Half rack cannot be imprinted
- Overall dimensions: 10" x 19¾" (25.4 x 50.2 cm)



52805
8-COMPARTMENT
 Diagonal 6" (15.24 cm)

ITEM #	DESCRIPTION	OVERALL HEIGHT: IN (CM)	INSIDE HEIGHT: IN (CM)	CASE LOT	COLORS
52805	8-cup	4½ (10.5)	2⅞ (7.3)	6	
52806	10-cup	4½ (10.5)	2⅞ (7.3)	6	

Signature Half-Size Compartment Racks

- 10-compartment: 3½" x 4⅝" (8.9 x 11 cm)
- 18-compartment: 2⅝" x 2⅜" (7.5 x 7.1 cm)
- Overall dimensions: 10" x 19½" (25.4 x 50.2 cm)



52821
10-COMPARTMENT
 Diagonal 5½" (14 cm)



52814
18-COMPARTMENT
 Diagonal 3⅞" (9.8 cm)

10-COMP	18-COMP	DESCRIPTION	OVERALL HEIGHT: IN (CM)	INSIDE HEIGHT: IN (CM)	CASE LOT	COLORS
52810	52814	Short	4½ (10.5)	2⅞ (7.3)	6	
52820	52823	Medium	5⅞ (14.5)	4½ (11.4)	4	
52821	52824	Tall	7⅞ (18.3)	6⅞ (15.4)	3	
52822	52825	X-tall	8⅞ (22.5)	7⅞ (19.5)	3	
52818	52826	XX-tall	10⅞ (26.4)	9⅞ (23.3)	2	

*Racks are made to order and cannot be returned.

Signature Half-Size Open and Flatware Racks

- Designed for uniquely shaped dishes and utensils
- Also used for transporting silverware cylinders
- Overall dimensions 10" x 19¼" (25.4 x 50.2 cm)

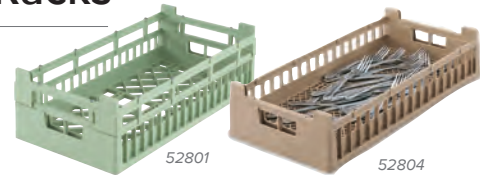

ITEM #	DESCRIPTION	INSIDE COMPARTMENT: IN (CM)	OVERALL HEIGHT: IN (CM)	INSIDE HEIGHT: IN (CM)	CASE LOT	COLORS
52800	Open short	9 x 18 ¹ / ₁₆ (22.9 x 45.9)	4 ¹ / ₈ (10.5)	2 ³ / ₄ (7)	6	
52801	Open medium	9 x 18 ¹ / ₁₆ (22.9 x 45.9)	5 ¹ / ₈ (14.1)	4 ¹ / ₄ (10.8)	4	
52802	Open tall	9 x 18 ¹ / ₁₆ (22.9 x 45.9)	7 ¹ / ₈ (18.1)	5 ³ / ₄ (14.6)	3	01 02
52803	Open X-tall	9 x 18 ¹ / ₁₆ (22.9 x 45.9)	8 ⁹ / ₁₆ (21.7)	7 ⁷ / ₈ (18.6)	3	
52807	Open XX-tall	9 x 18 ¹ / ₁₆ (22.9 x 45.9)	10 ¹ / ₈ (25.7)	8 ¹³ / ₁₆ (22.4)	2	
52804	Flatware	9 x 18 ¹ / ₁₆ (22.9 x 45.9)	4 ¹ / ₈ (10.5)	2 ⁷ / ₈ (6.7)	6	

Ordering Signature Rack Component Parts



See page 280 for additional Signature component parts.

FOR USE WITH RACK PART NUMBERS	SCREW LENGTH: IN (CM)	SCREW ITEM #	STYLE
52684, 52689, 52691, 52692, 52694, 52699, 52726, 52760, 52766, 52772, 52778, 52784, 52790, 52810, 52811, 52814	½" (1.3)	52355	Short compt.
52676, 52677, 52680	1 ¹ / ₈ " (4.8)	52356	Medium open
52693, 52702, 52710, 52714, 52718, 52722, 52727, 52761, 52767, 52773, 52779, 52785, 52798, 52812, 52813	2" (5.1)	52357	Medium compt.
52801			Med. open
52820, 52823	2¼" (5.7)	52358	Medium compt.
52681	3¼" (8.3)	52359	Tall, no compt.
52703, 52704, 52711, 52715, 52719, 52723, 52728, 52762, 52768, 52774, 52780, 52786, 52794, 52816, 52817	3½" (8.9)	52360	Tall compt.
52802			Tall open, no compt.
52821, 52824	3¾" (9.5)	52367	Tall compt.
52682	4 ⁵ / ₈ " (11.8)	52362	X-tall
52706, 52707, 52712, 52716, 52720, 52724, 52730, 52763, 52769, 52775, 52781, 52787, 52832, 52844	4 ⁷ / ₈ " (12.4)	52368	X-tall compt.
52803			X-tall open
52822, 52825	5 ³ / ₈ " (13.7)	52366	X-tall compt.
52683	5 ⁷ / ₈ " (14.9)	52369	XX-tall open
52708, 52709, 52713, 52717, 52721, 52725, 52729, 52764, 52770, 52776, 52782, 52788, 52845, 52846	6 ³ / ₈ " (16.2)	52363	XX-tall
52818, 52826	6 ³ / ₄ " (17.1)	52371	XX-tall compt.
52807			XX-tall open
52731, 52732, 52733, 52734, 52735, 52754, 52755, 52765, 52771, 52777, 52783, 52789, 52847, 52848	7 ¹ / ₈ " (19.8)	52370	XXX-tall
52736, 52737, 52738, 52739, 52740, 52757, 52849	9¼" (23.5)	52372	XXXX-tall

ITEM #	DESCRIPTION	CASE LOT
FULL-SIZE RACKS		
5230580	9-compartment divider	6
5230680	9-compartment trimmed divider	6
5230080	16-compartment divider	6
5230780	16-compartment trimmed divider	6
5231680	20-compartment divider	6
5231780	20-compartment trimmed divider	6
5231880	20 compartment extended divider	6
5230180	25 compartment divider	6
5230880	30-compartment divider	6
5232080	30-compartment trimmed divider	6
5232180	30-compartment divider	6
5232280	30 compartment extended divider	6
5230280	36-compartment divider	6
5230380	49-compartment divider	6
5230980	36-compartment trimmed divider	6
5231080	49-compartment trimmed divider	6
5230480	49-compartment trimmed divider	6
5230380	49-compartment divider	6
52304	Full-size riser	6

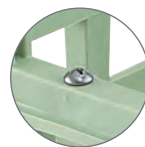

Rack assembly screws: set of sixteen screws in various lengths to fit all sizes of Vollrath racks

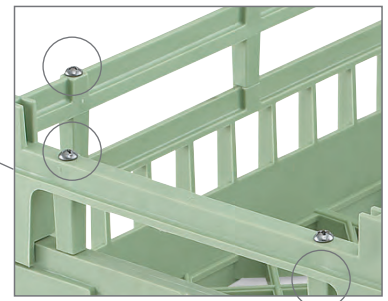

Changing glass sizes? For more information on risers and dividers for your Signature rack, see page 280.

ITEM #	DESCRIPTION	CASE LOT
HALF-SIZE RACKS		
52313	10-compartment divider	6
52311	10-compartment trimmed divider	6
52314	18-compartment divider	6
52312	18-compartment trimmed divider	6
52315	Riser	6

How to Order TRAEX® WARE- WASHING RACKS



Step 1 CHOOSE THE TYPE OF RACK YOU NEED

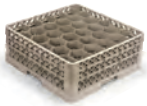

**OPEN
FULL-SIZE
RACKS**

Pages 266-273



**NEW CLOSED
FULL-SIZE
RACKS**

Pages 266-273



**HALF-SIZE
RACKS**

Page 274

Step 2 MEASURE

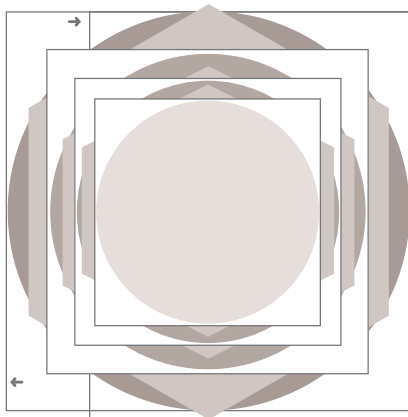

- Take the physical glass or mug you need to accommodate and flip to page 265. The chart will determine the appropriate rack height as well as the number of compartments to fulfill your needs.



Visit **VOLLRATH.com**

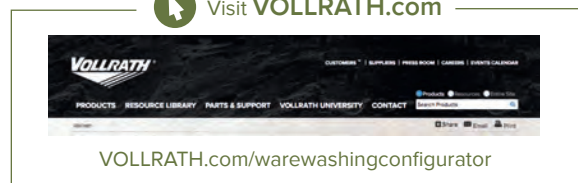

VOLLRATH.com/warewashingconfigurator

Step 3 SELECT YOUR BASIC RACK COLOR

- **ENTIRE RACK IN ONE COLOR** – To order an entire rack (base and extenders) in one color such as red (02), add the suffix to the end of the rack part number such as rack no. (TR6BBB) - color suffix (02): TR6BBB-02.
- **SINGLE EXTENDER IN ONE COLOR** – To order a beige rack with only the top extender in one color such as red (02), add a "9" plus the color suffix to the rack part number such as rack no. (TR6BBB-32) - (9) and color suffix (02): TR6BBB-32902.
- **ALL EXTENDERS IN ONE COLOR** – To order a green base rack with all extenders in one color such as red (02), add an "8" plus the color suffix to the rack part number such as rack no. (TR6BBB-19) - (8) and color suffix (02): TR6BBB-19802.
- Rack-Master® racks and extenders are available in five vibrant colors plus black and standard beige. To specify a color, add the color number (-02, -06, etc.) after the product number.
- Closed-wall rack bases are available only in beige, while extenders are available in all 7 colors.



32
beige (standard)



02
red



06
black



08
yellow



19
green



21
burgundy



44
royal blue



1007 Extended
Code-A-Clip

1006 Half-size
Code-A-Clip

1009 Full-size
Code-A-Clip

Step 4 CONSIDER CODE-A-CLIPS™ AND IMPRINTED CLIPS

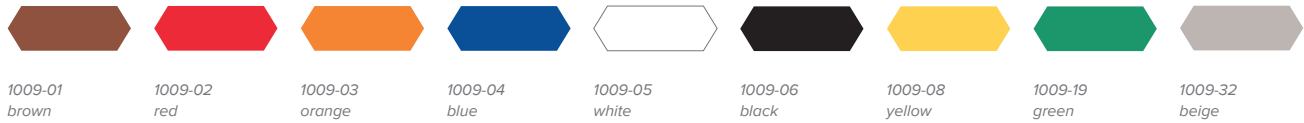

1009-01
brown

1009-02
red

1009-03
orange

1009-04
blue

1009-05
white

1009-06
black

1009-08
yellow

1009-19
green

1009-32
beige

- All full-size Code-A-Clips pictured here are stock and require no minimum order.
- Stock Code-A-Clips are white with black foil and plain colors as shown and have a die already available.
- Additional-stock Code-A-Clips dies available in white with black foil: liquor, soup cup, whiskey, parfait, sherry, cava, cordial, wine decant, soda, creamer, sugar, tubos, milk, stein, tea pot, child, bouillon. Ask your sales representative for more information.
- Let us customize a Code-A-Clips for your particular needs. Custom descriptions and silhouettes are available. Setup charge based on quote. When ordering custom clips, specify from the following clip colors: brown (01), red (02), orange (03), blue (04), white (05), black (06), yellow (08), green (19), and beige (32).
- Three dozen minimum required for custom Code-A-Clips.
- Custom foil imprint color options: red (02), blue (04), white (05), black (06), gold (14), green (19), and silver (28).

PLAIN FULL-SIZE CODE-A-CLIPS

- No. 1009-(clip color suffix)
- Length: 4¾", width: 1½"
- 12 pieces

IMPRINTED STOCK FULL-SIZE CODE-A-CLIPS

- No. 1009-(imprinted clip color no.)-(color foil color suffix)
- Minimum order of three dozen on custom orders only
- Length: 4¾", width: 1½"
- 12 pieces



#1009-1238-0506

HALF-SIZE CODE-A CLIPS

- No. 1006
- Length: 2¾", width: ¾"
- 96 pieces/17#
- Minimum order of 40 dozen on custom imprinted orders only and a 4-week lead time

PLAIN EXTENDER CODE-A CLIPS

- No. 1007-(clip color suffix)
- Length: 4¾", width: 1½"
- 12 pieces

IMPRINTED STOCK EXTENDER CODE-A-CLIPS

- No. 1007-(imprinted clip color no.)-(color foil color suffix)
- Length: 4¾", width: 1½"
- 12 pieces
- Minimum order of three dozen on custom orders only

	BEER		BEVERAGE		BRANDY
	BURGUNDER		CHAMPAGNE		COCKTAIL
	COFFEE MUG		COLLINS		CUP
	GOBLET		HI-BALL		ICED TEA
	JUICE		MARGARITA		MARTINI
	OLD FASHIONED		RED WINE		ROCKS
	TULIP CHAMPAGNE		WATER		WHITE WINE
	WINE	AGUA PARFAIT CORDIAL DINNER STEIN B&B SALAD SODA SOUP FLATWARE			

Step 5 ORDERING IMPRINTED RACKS

HOW TO ORDER

- Select the appropriate Rack-Master® rack for your equipment.
- Determine the artwork you would like imprinted: company name, company logo, phone number, glass name, and/or silhouette.
- Specify the rack color: red (02), black (06), yellow (08), green (19), burgundy (21), blue (44), or standard beige.
- Specify the imprint color: white (05) or black (06).



THINGS TO CONSIDER

- Custom-imprinted racks can be an assortment of racks as long as imprint is the same. Must be 36 pieces.
- Customizing information: Custom-imprinted or privately labeled products cannot be exchanged or returned.
- For your protection, registered trademarks (®) must have a letter of authorization prior to imprinting on products.
- Camera-ready artwork is required for all imprinting.
- Lead time of 10 days after approval of artwork.

Traex® Full- and Half-Size Rack Sizing Template

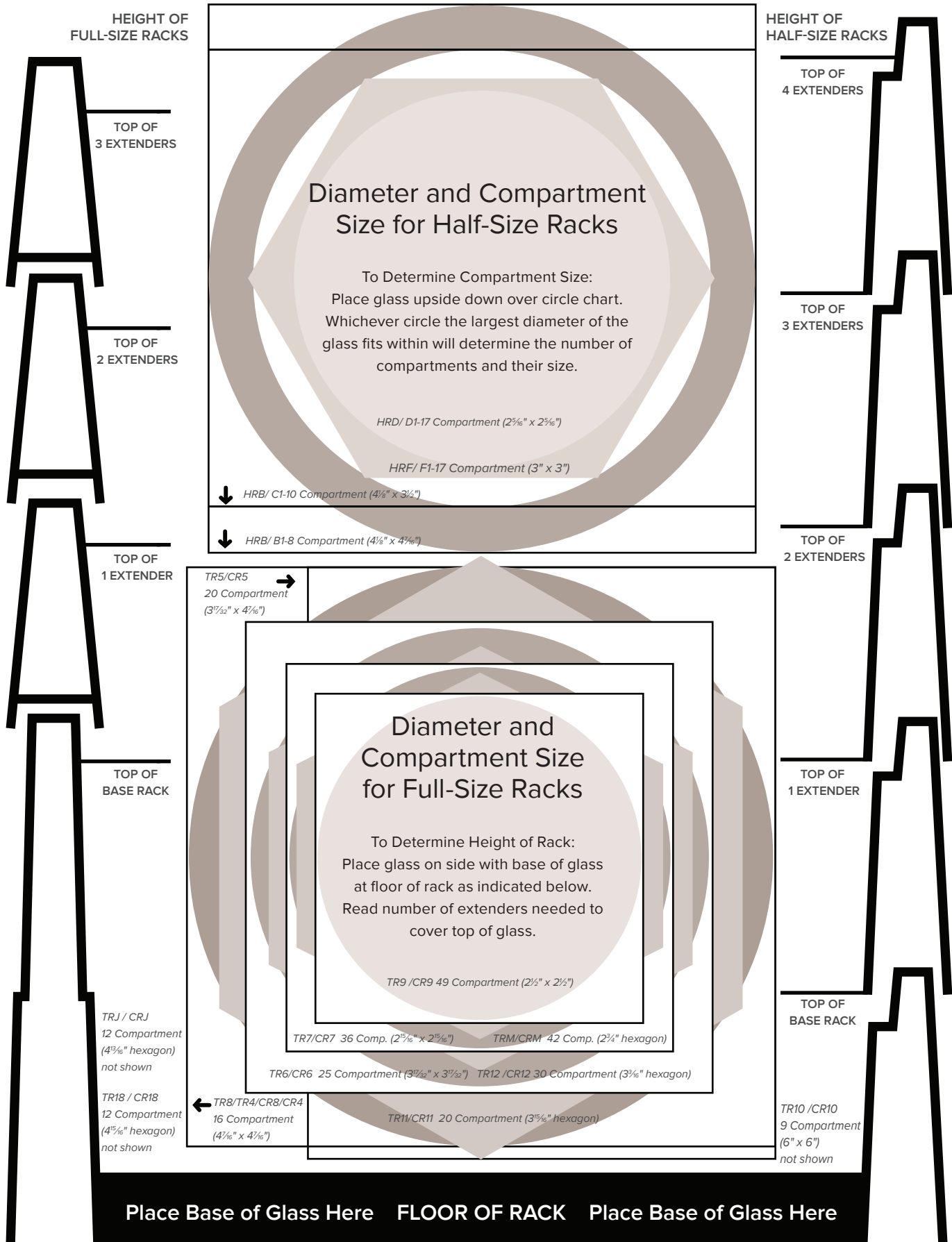

TRAEX® FULL-SIZE COMPARTMENT RACKS



Traex Open- and Closed-Wall Warewashing Racks

- Outstanding strength and durability, and adjustable warewashing system – flexible enough to accommodate virtually any glassware or smallware.

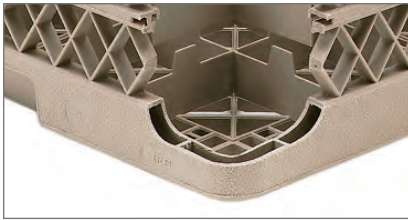

Traex built-in base rack dividers provide 100% vertical glassware protection.

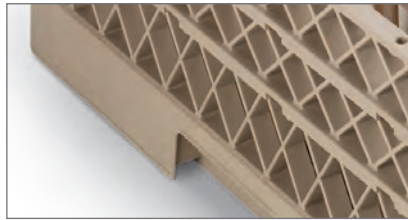

Traex open-profile design allows top-to-bottom and side-to-side washing and drying.



Traex snap-fit extenders will not loosen or come apart over time.



Traex convenient handling with handles on all four sides.



Add Traex Code-A-Clips for easy identification.



Closed-Wall Rack useful for storage and transportation.

Rack Max® 5, 12, 20, 30 & 42 Compartment Racks

- Designed to hold 17-30% more glassware than a traditional rack
- Small side compartments with mesh bottoms hold flatware, salt shakers, ramekins, etc.
- 100% vertical glassware protection
- Rack Max patent # 6,634,510



TR18JJ

discover SAVINGS

- Less Water
- Less Energy
- Fewer Chemicals
- Less Waste

TOTAL SAVINGS:
\$1,431+*
from increased capacity

Time & Labor = \$1,095
Water = \$56
Chemicals = \$192
Breakage = \$88

*Based on industry data for 20-compartment rack

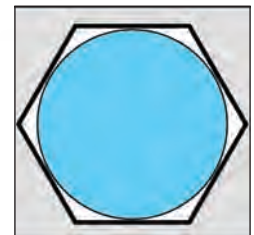

TRAEX RACK MAX DESIGN.

Traex® Full-Size Open-Wall Compartment Racks

OPEN PROFILE ALLOWS TOP-TO-BOTTOM AND SIDE-TO-SIDE THOROUGH WASHING AND AIR CIRCULATION

- Built-in base rack dividers provide 100% vertical protection
- Snap-fit extenders will not loosen over time or come apart
- Outside dimensions: 19¾" x 19¾" (50 x 50 cm)



TR10FF
9-COMPARTMENT
5⅞" (14.9 cm) sq. compartment
diagonal 8⅞" (21.1 cm)



TR18JJ
12-COMPARTMENT
4¾" (12.1 cm) diameter
Rack Max®



TR8DD
16-COMPARTMENT
4¾" (11.1 cm) sq. compartment
6⅞" (15.7 cm) diagonal



TR11GG
20-COMPARTMENT
3⅞" (10.0 cm) diameter
Rack Max



TR6BB
25-COMPARTMENT
3½" (8.9 cm) sq. compartment
4⅞" (12.5 cm) diagonal

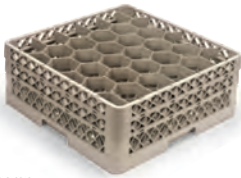

TR12HH
30-COMPARTMENT
3⅞" (8.1 cm) diameter
Rack Max



TR7CCC
36-COMPARTMENT
2⅞" (7.3 cm) sq. compartment
4⅞" (10.3 cm) diagonal

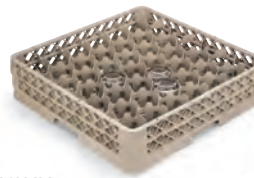

TR13MM
42-COMPARTMENT
2¾" (6.9 cm) diameter
Rack Max low-profile rack
available in beige only



TR9E
49-COMPARTMENT
2⅞" (6.2cm) sq. compartment
3⅞" (8.7 cm) diagonal

TRAEX STANDARD FULL-SIZE OPEN COMPARTMENT RACKS

9-COMP	12-COMP	16-COMP	20-COMP	25-COMP	30-COMP	36-COMP	49-COMP	OVERALL HEIGHT IN (CM)	INTERIOR HEIGHT IN (CM)	CASE LOT
TR10	TR18	TR8	TR11	TR6	TR12	TR7	TR9	4 (10.2)	3¼ (8.3)	6
TR10F	TR18J	TR8D	TR11G	TR6B	TR12H	TR7C	TR9E	5⅞ (14)	4⅞ (12.2)	2
TR10A	TR18A	TR8A	TR11A	TR6A	TR12A	TR7A	TR9A	5⅞ (14)	4⅞ (12.2)	2
TR10FF	TR18JJ	TR8DD	TR11GG	TR6BB	TR12HH	TR7CC	TR9EE	7⅞ (18.1)	6⅞ (16.2)	2
TR10FA	TR18JA	TR8DA	TR11GA	TR6BA	TR12HA	TR7CA	TR9EA	7⅞ (18.1)	6⅞ (16.2)	2
TR10FFF	TR18JJJ	TR8DDD	TR11GGG	TR6BBB	TR12HHH	TR7CCC	TR9EEE	8¾ (22.2)	7⅞ (20)	2
TR10FFA	TR18JJA	TR8DDA	TR11GGA	TR6BBA	TR12HHA	TR7CCA	TR9EEA	8¾ (22.2)	7⅞ (20)	2
TR10FFFF	TR18JJJJ	TR8DDDD	TR11GGGG	TR6BBBB	TR12HHHH	TR7CCCC	TR9EEEE	10⅞ (26.2)	9⅞ (24)	2
TR10FFFA	TR18JJJA	TR8DDDA	TR11GGGA	TR6BBBBB	TR12HHHA	TR7CCCA	TR9EEEA	10⅞ (26.2)	9⅞ (24)	2
TR10FFFFF	TR18JJJJJ	TR8DDDDD	TR11GGGGG	TR6BBBBB	TR12HHHHH	TR7CCCCC	TR9EEEE	11⅞ (30.2)	11 (27.9)	2
TR10FFFFA	TR18JJJJA	TR8DDDDA	TR11GGGGA	TR6BBBBBA	TR12HHHHA	TR7CCCCA	TR9EEEEA	11⅞ (30.2)	11 (27.9)	2

All item numbers ending in "A" have an open rack extender on top. Rack Max design.

TRAEX LOW-PROFILE FULL-SIZE OPEN COMPARTMENT RACKS

9-COMP	12-COMP	16-COMP	20-COMP	25-COMP	30-COMP	36-COMP	42-COMP*	OVERALL HEIGHT IN (CM)	INTERIOR HEIGHT IN (CM)	CASE LOT
TR13F	TR13J	TR13D	TR13G	TR13B	TR13H	TR13C	TR13M*	2⅞ (7.3)	2½ (6.4)	2
TR13FF	TR13JJ	TR13DD	TR13GG	TR13BB	TR13HH	TR13CC	TR13MM*	4½ (11.4)	3⅞ (9.1)	2
TR13FFF	TR13JJJ	TR13DDD	TR13GGG	TR13BBB	TR13HHH	TR13CCC	TR13MMM*	6⅞ (15.6)	5⅞ (13)	2
TR13FFFF	TR13JJJJ	TR13DDDD	TR13GGGG	TR13BBBB	TR13HHHH	TR13CCCC	TR13MMMM*	7⅞ (19.4)	6¾ (17.2)	2

TR13 and TRM racks are available only in beige. Low-profile racks cannot be imprinted.

*42-comp rack has alternate interior heights: TR13M: 1½" (3.8 cm), TR13MM: 3⅞" (7.9 cm), TR13MMM: 4¾" (12.1 cm), TR13MMMM: 6⅞" (16.2 cm)

COLORS



32
beige (standard)

02
red

06
black

08
yellow

19
green

21
burgundy

44
royal blue

Racks are made to order and cannot be returned.

NEW Traex® Full-Size Closed-Wall Compartment Racks

CLOSED-WALL RACK DESIGN – IDEAL FOR STORAGE AND TRANSPORTATION



- Eliminates need for rewashing
- Built-in base rack dividers provide 100% vertical protection
- Snap-fit extenders will not loosen over time or come apart
- Outside dimensions: 19¾" x 19¾" (50 x 50 cm)



CR10FF
9-COMPARTMENT
5½" (14.9 cm) sq. compartment
diagonal 8¾" (21.1 cm)



CR18JJ
12-COMPARTMENT
4¾" (12.1 cm) diameter
Rack Max®



CR8DD
16-COMPARTMENT
4¾" (11.1 cm) sq. compartment
6¾" (15.7 cm) diagonal



CR11GG
20-COMPARTMENT
3½" (10.0 cm) diameter
Rack Max



CR6BB
25-COMPARTMENT
3½" (8.9 cm) sq. compartment
4½" (12.5 cm) diagonal



CR12HH
30-COMPARTMENT
3¾" (8.1 cm) diameter
Rack Max



CR7CC
36-COMPARTMENT
2½" (7.3 cm) sq. compartment
4½" (10.3 cm) diagonal



CR9EE
49-COMPARTMENT
2½" (6.2 cm) sq. compartment
3½" (8.7 cm) diagonal

TRAEX STANDARD FULL-SIZE CLOSED-WALL COMPARTMENT RACKS

9-COMP	12-COMP	16-COMP	20-COMP	25-COMP	30-COMP	36-COMP	49-COMP	OVERALL HEIGHT IN (CM)	INTERIOR HEIGHT IN (CM)	CASE LOT
CR10	CR18	CR8	CR11	CR6	CR12	CR7	CR9	4 (10.2)	3¼ (8.3)	6
CR10F	CR18J	CR8D	CR11G	CR6B	CR12H	CR7C	CR9E	5½ (14)	4¾ (12.2)	2
CR10A	CR18A	CR8A	CR11A	CR6A	CR12A	CR7A	CR9A	5½ (14)	4¾ (12.2)	2
CR10FF	CR18JJ	CR8DD	CR11GG	CR6BB	CR12HH	CR7CC	CR9EE	7½ (18.1)	6¾ (16.2)	2
CR10FA	CR18JA	CR8DA	CR11GA	CR6BA	CR12HA	CR7CA	CR9EA	7½ (18.1)	6¾ (16.2)	2
CR10FFF	CR18JJJ	CR8DDD	CR11GGG	CR6BBB	CR12HHH	CR7CCC	CR9EEE	8¾ (22.2)	7½ (20)	2
CR10FFA	CR18JJA	CR8DDA	CR11GGA	CR6BBBA	CR12HHA	CR7CCA	CR9EEA	8¾ (22.2)	7½ (20)	2
CR10FFFF	CR18JJJJ	CR8DDDD	CR11GGGG	CR6BBBB	CR12HHHH	CR7CCCC	CR9EEEE	10¾ (26.2)	9¾ (24)	2
CR10FFFA	CR18JJJA	CR8DDDA	CR11GGGA	CR6BBBBB	CR12HHHA	CR7CCCA	CR9EEEA	10¾ (26.2)	9¾ (24)	2
CR10FFFFF	CR18JJJJJ	CR8DDDDD	CR11GGGGG	CR6BBBBB	CR12HHHHH	CR7CCCCC	CR9EEEEE	11¾ (30.2)	11 (27.9)	2
CR10FFFFA	CR18JJJJA	CR8DDDDA	CR11GGGGA	CR6BBBBBA	CR12HHHHA	CR7CCCCA	CR9EEEEA	11¾ (30.2)	11 (27.9)	2

*All item numbers ending in "A" have an open rack extender on top. Rack Max design – see page 266 for details.

TRAEX LOW-PROFILE FULL-SIZE CLOSED-WALL COMPARTMENT RACKS

9-COMP	12-COMP	16-COMP	20-COMP	25-COMP	30-COMP	36-COMP	42-COMP*	OVERALL HEIGHT IN (CM)	INTERIOR HEIGHT IN (CM)	CASE LOT
CR13F	CR13J	CR13D	CR13G	CR13B	CR13H	CR13C	CR13M*	2½ (7.3)	2½ (5.2)	2
CR13FF	CR13JJ	CR13DD	CR13GG	CR13BB	CR13HH	CR13CC	CR13MM*	4½ (11.4)	3¾ (9.1)	2
CR13FFF	CR13JJJ	CR13DDD	CR13GGG	CR13BBB	CR13HHH	CR13CCC	CR13MMM*	6¾ (15.6)	5½ (13)	2
CR13FFFF	CR13JJJJ	CR13DDDD	CR13GGGG	CR13BBBB	CR13HHHH	CR13CCCC	CR13MMMM*	7¾ (19.4)	6¾ (17.2)	2

CR13 racks are available only in beige. Low-profile racks cannot be imprinted.

*42-comp rack has alternative interior heights: CR13M: 1½" (3.8 cm), CR13MM: 3¾" (7.9 cm), CR13MMM: 4¾" (12.1 cm), CR13MMMM: 6¾" (16.2 cm)

COLORS FOR EXTENDERS ONLY



32 beige (standard) 02 red 06 black 08 yellow 19 green 21 burgundy 44 royal blue

Racks are made to order and cannot be returned.
Closed-wall rack bases are available in beige only while extenders are available in all 7 colors.

Traex® Full-Size Open & Closed Cup Racks



OPEN- & CLOSED-WALL DESIGNS

- Molded (1/2" H) tilt bar prevents water from pooling in bottom of cup
- Extra-high molded compartments prevent chipping and breakage
- CR16 are ideal for espresso cups with the 1" high compartment divider
- Outside dimensions: 19 3/4" x 19 3/4" (50 x 50 cm)



CR4
16-COMPARTMENT
4 7/16" (11.3 cm) sq. compartment
6 1/16" (15.4 cm) diagonal



TR5
20-COMPARTMENT
3 9/16" (9 cm) x 4 7/16" (11.3 cm) sq. compartment
Diagonal 5 3/16" (14.3 cm)



TR16
25-COMPARTMENT
3 7/16" (9 cm) sq. compartment
4 15/16" (12.5 cm) diagonal

OPEN-WALL 16-COMP	CLOSED-WALL 16-COMP	OPEN-WALL 20-COMP	CLOSED-WALL 20-COMP	OPEN-WALL 25-COMP	OVERALL HEIGHT: IN (CM)	INSIDE HEIGHT: IN (CM)	CASE LOT
TR4	CR4	TR5	CR5	TR16	4 (10.2)	3 (8.3)	6
TR4D	CR4D	—	—	TR16B	5 1/16 (14.1)	4 13/16 (12.2)	2
TR4A	CR4A	TR5A	CR5A	—	5 1/16 (14.1)	4 13/16 (12.2)	2
TR4DD	CR4DD	—	—	TR16BB	7 1/8 (18.1)	6 1/8 (16.2)	2
TR4DA	CR4DA	TR5AA	CR5AA	—	7 1/8 (18.1)	6 1/8 (16.2)	2
TR4DDD	CR4DDD	—	—	TR16BBB	8 3/4 (22.2)	7 1/8 (20)	2
TR4DDA	CR4DDA	—	—	—	8 3/4 (22.2)	7 1/8 (20)	2
TR4DDDD	CR4DDDD	—	—	TR16BBBB	10 5/8 (26.2)	9 1/8 (24)	2
TR4DDDA	TR4DDDA	—	—	—	10 5/8 (26.2)	9 1/8 (24)	2

COLORS

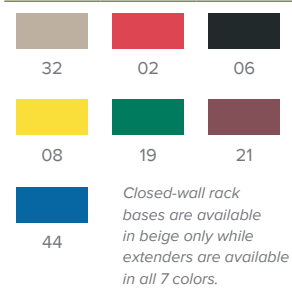

All item numbers ending in A have an open rack extender on top.

Traex Full-Size Flatware Racks

- Tight mesh bottom grid prevents flatware from falling through
- Racks have interior ribs that prevent knives from protruding through the side walls
- Outside dimensions: 19 3/4" x 19 3/4" (50 x 50 cm)



CR2



TR2

ITEM #	OPEN-WALL OR CLOSED-WALL	INSIDE COMPARTMENT: IN (CM)	OVERALL HEIGHT: IN (CM)	INSIDE HEIGHT: IN (CM)	CASE LOT
TR2	Open-Wall	18 1/8 x 18 1/8 (45.9 x 45.9)	4 (10.2)	3 1/4 (8.3)	6
CR2	Closed-Wall	18 1/8 x 18 1/8 (45.9 x 45.9)	4 (10.2)	3 1/4 (8.3)	6

COLORS

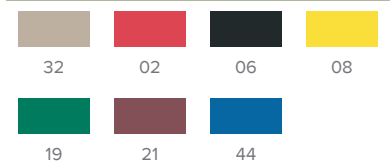

STORAGE SOLUTION TIP

- Our Closed-Wall Racks with rack cover make a great storage container for Vollrath Induction Buffet Warmers, Induction Chafers and Stands.

See pages 29-33 and 199 for product details.



Traex® Full-Size Combination Rack (½ Open, ½ Peg)

- Combination rack for flatware, china, pitchers, or urns
- Special corner to accommodate a #1370 flatware cylinder, sold separately
- Outside dimensions: 19¾" x 19¾" (50 x 50 cm)



TR15



ITEM #	INSIDE COMPARTMENT: IN (CM)	OVERALL HEIGHT: IN (CM)	INSIDE HEIGHT: IN (CM)	CASE LOT	COLOR
TR15	18⅞ x 18⅞ (45.9 x 45.9)	4 (10.2)	3¼ (8.3)	6	32

Racks are made to order and cannot be returned

Traex Full-Size Open & Compartment Racks

OPEN- & CLOSED-WALL DESIGNS

- Open compartment racks are designed for uniquely shaped or oversized dishes, utensils, and cookware
- TR13A low-profile rack allows for compact and efficient washing – perfect for storing items like ramekins and ashtrays
- Outside dimensions: 19¾" x 19¾" (50 x 50 cm)



TR1

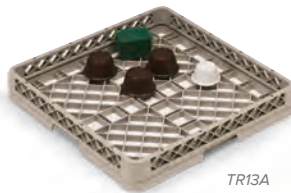

TR13A



CR1AA



CR1AAAA

OPEN-WALL ITEM #	CLOSED-WALL ITEM #	DESCRIPTION	OVERALL HEIGHT: IN (CM)	INSIDE HEIGHT: IN (CM)	CASE LOT
TRAEX OPEN RACKS					
TR1	CR1	Rack	4 (10.2)	3¼ (8.3)	6
TR1A	CR1A	Rack/extender	5⅞ (14.1)	4⅞ (12.2)	2
TR1AA	CR1AA	Rack/2 extenders	7⅞ (18.1)	6⅞ (16.2)	2
TR1AAA	CR1AAA	Rack/3 extenders	8¾ (22.2)	7⅞ (20)	2
TR1AAAA	CR1AAAA	Rack/4 extenders	10⅞ (26.2)	9⅞ (24)	2
TR1AAAAA	CR1AAAAA	Rack/5 extenders	11⅞ (30.2)	11 (27.9)	2
TRAEX LOW-PROFILE OPEN RACKS*					
TR13A	CR13A	Rack/extender	3 (7.6)	2¼ (5.7)	2

COLORS			
32	02	06	08
19	21	44	

Closed-wall rack bases are available in beige only while extenders are available in all 7 colors.

*Traex low-profile TR13/CR13 open racks are available in beige only and cannot be imprinted.

Traex® Full-Size Rack Max® Pitcher Racks

- Ideal for super-sized glassware, pitchers, and coffee urns
- Compartment (7½" diameter)
- Dividers provide complete vertical protection
- Compartment size: 7½" (19.5 cm) diameter



TR13K K K K K K
5-COMPARTMENT
 7½" (19.5 cm) sq. compartment
 8" (20.32 cm) diagonal



ITEM #	DESCRIPTION	OVERALL HEIGHT: IN (CM)	INSIDE HEIGHT: IN (CM)	CASE LOT	COLOR
TR13K K K K K *	4 extenders	7½ (19.4)	6¾ (16.2)	2	32
TR13K K K K K K *	5 extenders	9¾ (23.3)	8 (20.32)	2	
TR13K K K K K K K *	6 extenders	10¾ (8.3)	9¾ (24.45)	1	

*Traex TR13 rack bases are available in beige only and cannot be imprinted.

Traex Full-Size Plate Racks

OPEN- & CLOSED-WALL DESIGNS

- Holds plates and trays upright for the ideal cleaning angle, preventing chipping and breakage
- Outside dimensions: 19¾" x 19¾" (50 x 50 cm)
- TRPEG adds 3" to a standard peg rack and helps prevent large plate breakage; the peg fits only on the Traex TR3 rack
- Pegs are permanently snapped onto the TR3AAP14 and TR3AAP16

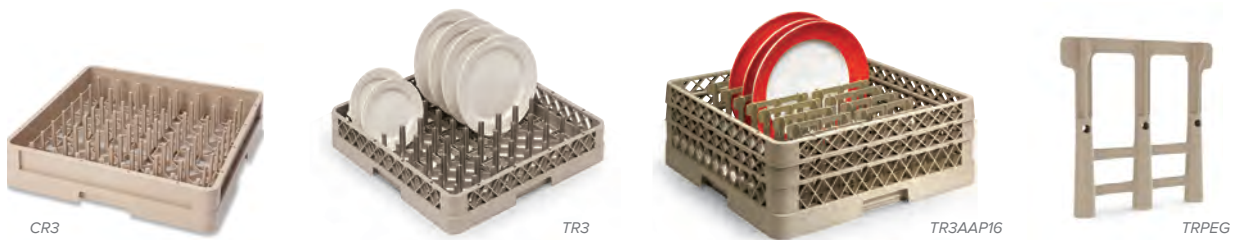



OPEN-WALL ITEM #	CLOSED-WALL ITEM #	DESCRIPTION	OVERALL HEIGHT	INSIDE HEIGHT	PEG HEIGHT	ROWS	PEGS SPACING	CASE LOT	COLORS	
TRAEX FULL-SIZE PLATE RACKS										
TR3**	CR3**	Peg rack	4 (10.2)	3¼ (8.3)	2¾ (7.3)	9 x 9	1½ (4.8)	6	32	02
TR14* **	—	High-efficiency peg rack	4 (10.2)	3¼ (8.3)	3 (7.6)	9 x 8	1¼ (4.4)	6	06	08
TRAEX FULL-SIZE EXTENDED PLATE RACKS										
TR3AAP14*	CR3AAP14*	Up to 12¼" (31.3 cm) plate diameter	7½ (18.1)	6¾ (16.2)	6 (15.2)	9	—	1	21	44
TR3AAP16*	CR3AAP16*	Up to 18¾" (45.9 cm) plate diameter	7½ (18.1)	6¾ (16.2)	6 (15.2)	7	—	1		
TRPEG*	—	Peg (fits TR3)	6 (15.2)	—	6 (15.2)	—	—	1		

All item numbers ending in A have an open rack extender on top. *Available in beige (32) only **NSF® certified
 Racks are made to order and cannot be returned.

Traex® Tray & Pan Rack

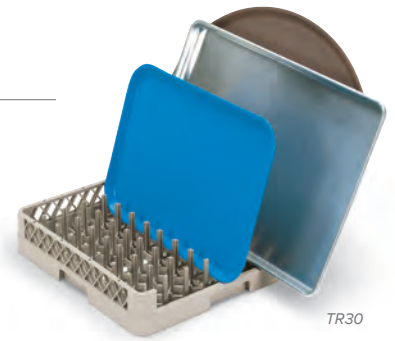
- Ideal for washing trays
- Full “beam wall” prevents rack from flexing under heavy loads
- Outside dimensions: 19¾" x 19¾" (50 x 50 cm)



ITEM #	DESCRIPTION	OVERALL HEIGHT: IN (CM)	INSIDE HEIGHT: IN (CM)	CASE LOT	COLOR
TR30*	Open-end	4 (10.2)	3¼ (8.3)	6	

*Available in beige (32) only

32

Traex Insulated Tray and Steam Table Pan Rack

- Designed to wash insulated foodservice trays and 2½" deep (6.5 cm) steam table pans
- TR22 is ideal for steam table pans, insulated trays, and plate covers
- Outside dimensions: 19¾" x 19¾" (50 x 50 cm)

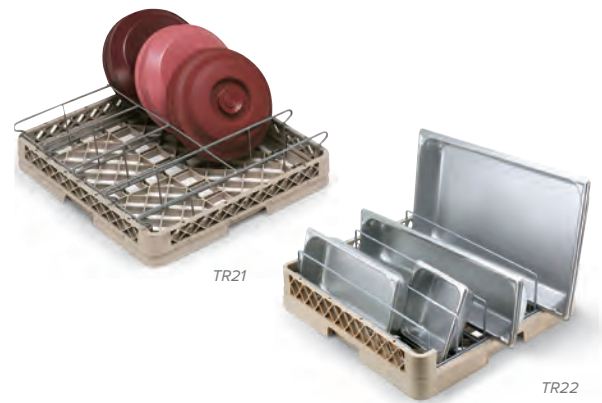

ITEM #	DESCRIPTION	OVERALL HEIGHT: IN (CM)	INSIDE HEIGHT: IN (CM)	SPACING	CASE LOT	COLOR
TR21*	Up to 9¾" (24.8 cm) plate cover diameter with powder-coated insert	4¾ (12.1)	3¼ (8.3)	3⅞ (7.9)	1	
TR22*	Open-end food pan and insulated tray rack with powder-coated insert	5¼ (13.3)	5¼ (13.3)	3 (7.6)	1	32
TR31**	Open-end rack	5¼ (13.3)	5¼ (13.3)	—	1	

*Available in beige (32) only

**NSF® certified

Traex Sheet Pan Racks

- Holds three full-size sheet pans
- Designed to fit standard-height openings for all conveyor-type dishwashers
- Outside dimensions: 19¾" x 19¾" (50 x 50 cm)



ITEM #	DESCRIPTION	OVERALL HEIGHT: IN (CM)	INSIDE HEIGHT: IN (CM)	SPACING	CASE LOT	COLOR
TR23*	Open-end rack with vinyl coated insert	5¼ (13.3)	5¼ (13.3)	3 (7.6)	1	
TR31**	Open-end rack	5¼ (13.3)	5¼ (13.3)	—	1	32

*Available in beige (32) only

**NSF certified

*Racks are made to order and cannot be returned.

TRAEX® PLATE CRATE® WASHING SYSTEM

- 20 different Plate Crates give operators the perfect crate for washing, storing, and transporting china
- Plate Crates consist of a TR1 base rack and wire grids that snap into TRA Open Extenders
- Less breakage, cleaner china, faster drying, stackability, durability, convenient handling, and shorter lead time
- Plate Crate racks are available in five vibrant colors plus black and standard beige
- To specify a color, add the color number (-02, -06, etc.) after the product number

- LESS BREAKAGE
- CLEANER CHINA
- FASTER DRYING
- STACKABILITY
- DURABILITY
- CONVENIENT HANDLING

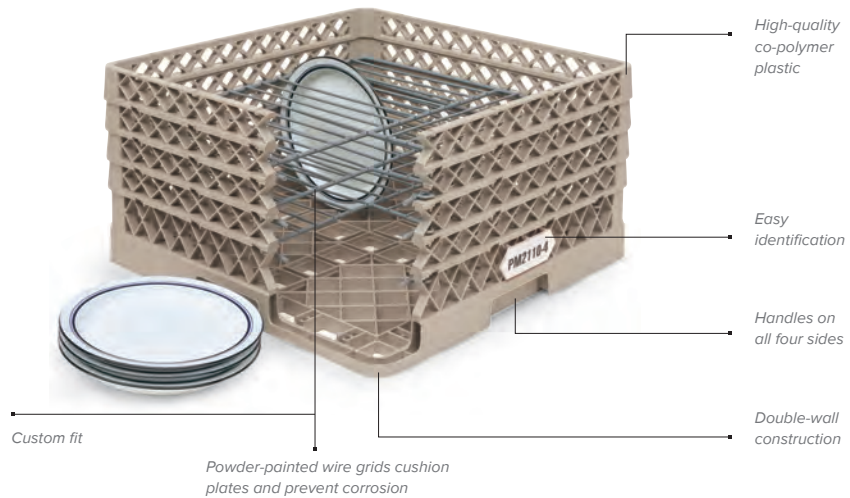

ITEM #	DESCRIPTION	PLATE SIZE RANGE: IN (CM)	PLATE DEPTH: IN (CM)	GRID #	PLATES PER RACK	CASE LOT
PM1412-6	Plate rack w/6 extenders	10¾ to 12¾ (27.3 to 31.3)	Up to 1¾ (3.5)	92235	14	1
PM1912-6	Plate rack w/6 extenders	11 to 12 (28 to 30.5)	Up to 1 (2.5)	92215	19	1
PM0912-6	Plate rack w/6 extenders	11¼ to 12½ (28.6 to 31.8)	Up to 2¾ (6)	92231	9	1
PM1211-6	Plate rack w/6 extenders	10¾ to 11¾ (27.3 to 28.4)	Up to 1¾ (4.4)	92233	12	1
PM2011-6	Plate rack w/6 extenders	10¾ to 11 (27.3 to 28)	Up to 1 (2.5)	92216	20	1
PM1510-5	Plate rack w/5 extenders	9 to 10¾ (22.9 to 27.3)	Up to 1¾ (3.5)	92234	15	2
PM1211-5	Plate rack w/5 extenders	9¾ to 10¾ (23.3 to 27.3)	Up to 1¾ (4.4)	92233	12	2
PM2011-5	Plate rack w/5 extenders	10 to 10¾ (25.4 to 27.3)	Up to 1 (2.5)	92216	20	2
PM2110-5	Plate rack w/5 extenders	9¾ to 10 (23.3 to 25.4)	Up to 1 (2.5)	92217	21	2
PM1510-4	Plate rack w/4 extenders	8¾ to 9¾ (22.3 to 23.3)	Up to 1¾ (3.5)	92234	15	2
PM1211-4	Plate rack w/4 extenders	8¾ to 9¾ (22.3 to 23.3)	Up to 1¾ (4.4)	92233	12	2
PM2110-4	Plate rack w/4 extenders	8¾ to 9¾ (22.3 to 23.3)	Up to 1 (2.5)	92217	21	2
PM2209-4	Plate rack w/4 extenders	7 to 8¾ (17.8 to 22.3)	Up to 1¾ (3.5)	92228	22	2
PM3008-4	Plate rack w/4 extenders	8 to 8¾ (20.3 to 21.3)	Up to 1 (2.5)	92218	30	2
PM3208-4	Plate rack w/4 extenders	7¾ to 8 (19.7 to 20.3)	Up to 1 (2.5)	92219	32	2
PM1211-3	Plate rack w/3 extenders	5 to 7¾ (12.7 to 19.7)	Up to 1¾ (4.4)	92233	12	2
PM3208-3	Plate rack w/3 extenders	4¾ to 7¾ (12.1 to 19.7)	Up to 1 (2.5)	92219	32	2
PM4407-3	Plate rack w/3 extenders	6 to 7¾ (15.2 to 17.8)	Up to ¾ (1.9)	92220	44	2
PM2006-3	Plate rack w/3 extenders	4¾ to 6½ (12.1 to 16.5)	Up to 2 (5.1)	92232	20	2
PM2209-3	Plate rack w/3 extenders	7 to 7¾ (17.8 to 20)	Up to 1¾ (3.5)	92228	22	2
PM4806-2	Plate rack w/2 extenders	4 to 6 (10.6 to 15.2)	Up to ¾ (1.9)	92221	48	2
PM3807-2	Plate rack w/2 extenders	4 to 6 (10.6 to 15.2)	Up to 1 (2.5)	92236	38	2
PM3208-2	Plate rack w/2 extenders	4¾ to 6¾ (12.1 to 15.9)	Up to 1 (2.5)	92219	32	2

COLORS



*Racks are made to order and cannot be returned.

TRAEX® HALF-SIZE COMPARTMENT RACKS



Traex Half-Size Glass Rack

- All half bases and extenders are available only in standard beige
- Snap-fit extenders will not loosen over time or come apart



HR1B1
8-COMPARTMENT
 4½" (10.5 cm) x 4⅞" (11.3 cm)
 Diagonal 5⅞"



HR1C1C
10-COMPARTMENT
 4½" (10.5 cm) x 3½" (8.9 cm)
 Diagonal 5¼"



HR1D1DD
17-COMPARTMENT (2½" dia)
 2½" diameter (7.5 cm)



HR1F
17-COMPARTMENT (3" dia)
 3" diameter (7.6 cm)

8-COMP	10-COMP	17-COMP	17-COMP	OVERALL HEIGHT: IN (CM)	INSIDE HEIGHT: IN (CM)	CASE LOT	COLOR
HR1	HR1	HR1	HR1	2⅞ (5.2)	1¼ (3.2)	12	32
HR1B1	HR1C1	HR1D1	HR1F	3⅞ (9.7)	3 (7.6)	6	
HR1B1B	HR1C1C	HR1D1D	HR1FF	5⅞ (14.1)	4¾ (12.1)	4	
HR1B1A	HR1C1A	HR1D1A	HR1FA	5⅞ (14.1)	4¾ (12.1)	4	
HR1B1BB	HR1C1CC	HR1D1DD	HR1FFF	7⅞ (18.6)	6½ (16.5)	2	
HR1B1BA	HR1C1CA	HR1D1DA	HR1FFA	7⅞ (18.6)	6½ (16.5)	2	
HR1B1BBB	HR1C1CCC	HR1D1DDD	HR1FFFF	9⅞ (23)	8¼ (20.1)	2	
HR1B1BBA	HR1C1CCA	HR1D1DDA	TR10FFFA	9⅞ (23)	8¼ (20.1)	2	

Note: Traex half-size glass racks cannot be imprinted.

Traex Half-Size Open and Flatware Racks

- Designed for uniquely shaped dishes and utensils
- Also used for transporting silverware cylinders



ITEM #	DESCRIPTION	INSIDE COMPARTMENT	OVERALL HEIGHT: IN (CM)	INSIDE HEIGHT: IN (CM)	CASE LOT	COLOR
HR1A	Open half rack w/1 extender	9 x 18⅞ (22.9 x 45.9)	3⅞ (9.7)	3 (7.6)	6	32
HR1AA	Open half rack w/2 open extenders	9 x 18⅞ (22.9 x 45.9)	5⅞ (14.1)	4¾ (12.1)	4	
HR1AAA	Open half rack w/3 open extenders	9 x 18⅞ (22.9 x 45.9)	7⅞ (18.6)	6½ (16.5)	2	
HR1AAAA	Open half rack w/4 open extenders	9 x 18⅞ (22.9 x 45.9)	9⅞ (23)	8¼ (20.1)	2	
HR2A	Flatware half rack w/1 extender	9 x 18⅞ (22.9 x 46)	3⅞ (9.7)	3 (7.7)	6	

*Racks are made to order and cannot be returned.

SIGNATURE FLATWARE RACKS & ACCESSORIES

Signature Half-Size Flatware Racks

- Mesh bottom prevents flatware from falling through
- Inside compartment size: 9" x 18 $\frac{1}{16}$ " (22.9 x 46 cm)
- Overall dimensions: 10" x 19 $\frac{1}{4}$ " (25.4 x 50.2 cm)



52804

ITEM #	DESCRIPTION	INSIDE COMPARTMENT: IN (CM)	OVERALL HEIGHT: IN (CM)	INSIDE HEIGHT: IN (CM)	CASE LOT	COLORS
52804	Flatware half rack	9 x 18 $\frac{1}{16}$ (22.9 x 46)	4 $\frac{1}{8}$ (10.5)	2 $\frac{3}{8}$ (6.7)	6	<div style="display: flex; justify-content: space-around;"> <div style="width: 20px; height: 20px; background-color: #4CAF50; border: 1px solid black;"></div> <div style="width: 20px; height: 20px; background-color: #A52A2A; border: 1px solid black;"></div> </div> <p style="text-align: center; font-size: small;">01 02</p>

Signature Flatware Washing System

- Employees handle only the system containers for safer and more sanitary conditions
- Rack transfers directly to dishwasher



97285

ITEM #	DESCRIPTION	CASE LOT	COLOR
97285	Includes: 3 of 1390 (soak tubs), 6 of 52804 (flatware racks), 3 of 52802 (open racks), and 8 of 52643 (white plastic cylinders)	1	<div style="width: 20px; height: 20px; background-color: #A52A2A; border: 1px solid black;"></div> <p style="text-align: center; font-size: small;">02</p>

Silverware Soak System

- Box with drain holes nests into soaking pan for pre-cleaning
- Safely keeps hands away from harsh chemicals and sharp knives
- System includes drain box (52617), bus box (52612), and cover (52424)



52619 and 52617

ITEM #	DESCRIPTION	CASE LOT	COLOR
52619	Silverware soak system, grey, includes 52612, 52424, and 52617	1	<div style="width: 20px; height: 20px; background-color: #696969; border: 1px solid black;"></div> <p style="text-align: center; font-size: small;">06</p>
52617	Perforated drain box only, grey, 20" x 15" x 5" (50.8 x 38.1 x 12.7 cm)	6	

*Racks are made to order and cannot be returned.

Flatware Soak & Washing System

- Allows pre-soak, wash, and transport for faster handling and less labor
- Rack's tight mesh bottom keeps flatware in place with free-flow solution
- Rack transfers directly to dishwasher
- 97300 stainless steel stand allows for three tubs with minimal use of counter space



52827 and 97300



ITEM #	DESCRIPTION	DIMENSIONS: IN (CM)	CASE LOT	COLOR
52827	Signature soak system half rack and tub	24 $\frac{3}{8}$ x 13 $\frac{1}{2}$ x 5 $\frac{7}{8}$ (62.3 x 34.3 x 13.8)	1	 02
52804	Signature half-size flatware rack only	9 x 18 $\frac{1}{2}$ x 4 $\frac{1}{8}$ (23 x 47 x 10.5)	6	
97300	Signature soak system stand only	12 x 11 x 9 (30.5 x 28 x 23)	1	

8-Compartment Flatware Baskets

- Two baskets fit on a full-size open rack
- Inside compartment: 3 $\frac{3}{8}$ " x 3 $\frac{3}{8}$ " x 4 $\frac{1}{4}$ " (9 x 9 x 10.8 cm)
- Baskets nest for compact storage

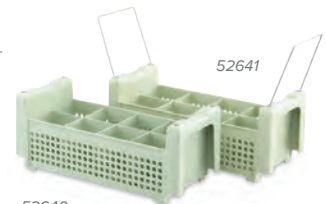

52640



ITEM #	DESCRIPTION	INSIDE COMPARTMENT: IN (CM)	OVERALL HEIGHT: IN (CM)	INSIDE HEIGHT: IN (CM)	CASE LOT	COLOR
52640	Signature basket w/out handles	3 $\frac{3}{8}$ x 3 $\frac{3}{8}$ (9 x 9)	7 $\frac{1}{2}$ (18.4)	4 $\frac{1}{4}$ (10.8)	4	 01
52641	Signature basket w/handles	3 $\frac{3}{8}$ x 3 $\frac{3}{8}$ (9 x 9)	13 $\frac{3}{8}$ (34.5)	4 $\frac{1}{4}$ (10.8)	4	

Signature Silverware Cutlery Boxes

- Heavy-duty plastic with four rounded compartments
- May also use for storing packaged straws and condiment packets
- 99700 is heavy-duty stainless steel with four rounded corners
- 52651 has an overflow cutout



ITEM #	DESCRIPTION	DIMENSIONS: IN (CM)	CASE LOT
52653	Black polyethylene	21 $\frac{1}{8}$ x 11 $\frac{1}{8}$ x 3 $\frac{3}{4}$ (54.9 x 30.2 x 9.5)	12
52654	Grey polyethylene	21 $\frac{1}{8}$ x 11 $\frac{1}{8}$ x 3 $\frac{3}{4}$ (54.9 x 30.2 x 9.5)	12
52651	Grey polyethylene, w/ overflow cutout	21 $\frac{1}{8}$ x 11 $\frac{1}{8}$ x 4 (54.3 x 29.4 x 10.2)	6
99700	Stainless steel bin	17 x 10 $\frac{1}{4}$ x 3 $\frac{3}{4}$ (43.2 x 26 x 9.5)	6
52652	Brown plastic bin	20 x 10 x 4 (50.8 x 25.4 x 10.2)	6

Signature Vertical Flatware Washing System, Cylinders & Storage

- Heavy-duty, long-wearing
- Cylinders (sold separately) fit into cylinder washing rack and Silv-A-Tainer™
- Vertical washing and drying is preferred for flatware
- Items 52633, 52643, 1370, 52642, 52808, HR1370, HR2D1DDA, and 97241 are NSF® certified

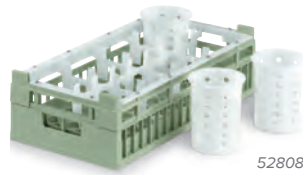
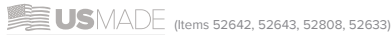

ITEM #	DESCRIPTION	DIMENSIONS: IN (CM)	CASE LOT
52633*	Black plastic cylinder	3¾ dia x 5⅝ (9.5 dia x 14.3)	12
52643*	White plastic cylinder	3¾ dia x 5⅝ (9.5 dia x 14.3)	12
52642*	Nylon cylinder	3¾ dia x 5⅝ (9.5 dia x 14.3)	12
99710	Stainless cylinder	3¾ dia x 5⅝ (9.5 dia x 14.3)	12
52808	8-compartment cylinder rack	19¾ x 10 x 5⅝ (50 x 25.4 x 14.1)	4
97241**	6-cylinder stainless Silv-A-Tainer	14⅞ x 11½ x 8½ (37.8 x 29.2 x 21.6)	1
97240**	4-cylinder stainless Silv-A-Tainer	10⅞ x 11½ x 8½ (25.7 x 29.2 x 21.6)	1
52644**	6-cylinder plastic Silv-A-Tainer	15⅞ x 10¾ x 11 (38.4 x 27.3 x 27.9)	1

*NSF certified

**Cylinders sold separately

Signature Hold-Down Grids

- Plastisol coating to protect rack items
- Grid keeps small objects in place during washing, even under high water pressure



ITEM #	DESCRIPTION	DIMENSIONS: IN (CM)	CASE LOT
52385	Signature full-size grid only	17⅞ x 17⅞ (45.4 x 45.4)	12

SIGNATURE BUS BOXES & COVERS

Signature Bus Boxes

- Signature boxes have smooth interior bottom, ribbed exterior bottom, and a hole in the handle for easy drainage
- Stacking lugs prevent sticking together and allow for quicker drying
- Reinforced handles
- Made of high-density polyethylene
- Withstands temperatures between -30° and 180°F



ITEM #	DESCRIPTION	COLOR	DIMENSIONS (L X W X H): IN (CM)	CASE LOT
52629*	Signature undercounter bus box	Grey	20 x 12 x 6 (50.8 x 30.5 x 15.2)	12
52611	Signature single-compartment bus box	Black	20 x 15 x 5 (50.8 x 38.1 x 12.7)	12
52612	Signature single-compartment bus box	Grey	20 x 15 x 5 (50.8 x 38.1 x 12.7)	12
52614	Signature single-compartment bus box	Brown	20 x 15 x 5 (50.8 x 38.1 x 12.7)	12
52615	Signature single-compartment bus box	Natural	20 x 15 x 5 (50.8 x 38.1 x 12.7)	12
52621	Signature single-compartment bus box	Grey	20 x 17 x 5 (50.8 x 43.2 x 12.7)	12
52622	Signature single-compartment bus box	Black	20 x 17 x 5 (50.8 x 43.2 x 12.7)	12
52657	Signature heavy-duty single-compartment bus box	Natural	20 x 15 x 7 (50.8 x 38.1 x 17.8)	12
52660	Signature heavy-duty single-compartment bus box	Black	20 x 15 x 7 (50.8 x 38.1 x 17.8)	12
52661	Signature heavy-duty single-compartment bus box	Grey	20 x 15 x 7 (50.8 x 38.1 x 17.8)	12
52662	Signature heavy-duty single-compartment bus box	Brown	20 x 15 x 7 (50.8 x 38.1 x 17.8)	12
52632	Signature heavy-duty two-compartment bus box	Grey	23 x 17½ x 6 (58.4 x 44.5 x 15.2)	6
52634	Signature heavy-duty two-compartment bus box	Black	23 x 17½ x 6 (58.4 x 44.5 x 15.2)	6

*Not NSF® certified

Signature Bus Box Covers

- 52422, 52424, and 52420 fit Signature and Traex 5" and 7" boxes

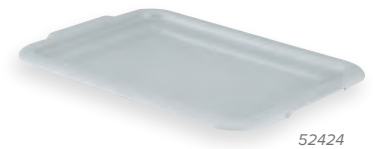

ITEM #	DESCRIPTION	COLOR	DIMENSIONS (L X W X H): IN (CM)	CASE LOT
52422	Signature universal recessed cover	Natural	20 x 15 (50.8 x 38.1)	12
52424	Signature universal recessed cover	Grey	20 x 15 (50.8 x 38.1)	12
52420	Signature universal recessed cover	Black	20 x 15 (50.8 x 38.1)	12

Cup Max™ & Glass Max™ Stackers

- Cup Max stacker accommodates cups with minimum 3" inside diameter, maximum 3½" outside diameter, maximum 2¾" base diameter
- Glass Max stacker accommodates glasses with minimum 2" inside diameter, maximum 3¼" outside diameter, maximum 2⅞" base diameter



ITEM #	DESCRIPTION	DIMENSIONS (L X W): IN (CM)	CAPACITY	CASE LOT
CS15-32	Cup Max stacker	18 x 14 (45.7 x 35.6)	15 cups	6
GS21-32	Glass Max stacker	18 x 14 (45.7 x 35.6)	21 glasses	6

SIGNATURE DOLLIES



Signature Plastic Rack Dollies

- Provide smooth, safe transport for all full-size racks
- Specialized formulation of polypropylene designed to resist rust and corrosion and withstand elevated temperatures
- Available in two configurations using 3" (7.6 cm) non-marking casters
- Optional removable, carbon steel, chrome-plated 27" (68.6 cm) handle
- Optional black ABS plastic insert catches drainage when transporting wet racks or serves as a cover to keep dust off when storing
- Overall height: with handle 33" (83.8 cm); dolly height only: 5¹/₁₆" (14.5 cm)
- Weight capacity: 200 lbs (90 kg)
- Handle and insert sold separately



ITEM #	DESCRIPTION	PLATFORM DIMENSIONS (L X W): IN (CM)	CASE LOT
52290	Dolly only with 4 swivel casters	20 x 20 (50.8 x 50.8)	1
52292	Dolly only with 2 swivel (back) and 2 fixed (front) casters	20 x 20 (50.8 x 50.8)	1
52293	Handle only	–	1
52291	Dish-rack dolly insert and cover	–	1

Signature Steel Rack Dolly

- Constructed from heavy-gauge steel
- Holds full-size racks
- Zinc-plated carbon steel dolly absorbs shock
- Use as a can dolly or stacked-chair dolly
- 4" (10.2 cm) non-marking casters
- Overall height: with handle 33" (83.8 cm); dolly only: 5⁷/₈" (14.9 cm)
- Weight capacity: 200 lbs (90 kg)
- Handle sold separately



ITEM #	DESCRIPTION	GAUGE	PLATFORM DIMENSIONS (L X W): IN (CM)	CASE LOT
97190	Dolly without handle	12	20 ¹ / ₂ x 20 ¹ / ₂ (52.1 x 52.1)	1
97191	Handle only, chrome plated	18	–	1

SIGNATURE COMPONENT PARTS



Changing glass sizes? Convert your existing Signature component racks with Signature component parts. See page 262.

NUMBER OF COMPARTMENTS COMPARTMENT SIZE: IN (CM)	9 5 $\frac{1}{8}$ (14.9)	16 4 $\frac{3}{8}$ (10.0)	20 3 $\frac{5}{16}$ (11.1)	25 3 $\frac{1}{2}$ (8.9)	30 3 $\frac{3}{16}$ (8.1)	36 2 $\frac{1}{2}$ (7.3)	49 2 $\frac{1}{16}$ (6.2)	RACK COMPONENTS
SHORT Overall ht. 4 $\frac{1}{8}$ (10.5) Inside ht. 2 $\frac{3}{16}$ (7.1)	52726	52694	52691	52684	52790	52689	52699	NO RISERS ONE DIVIDER
SHORT PLUS Overall ht. 4 $\frac{7}{8}$ (12.4) Inside ht. 3 $\frac{3}{4}$ (8.3)	52760	52766	52692	52772	52811	52778	52784	
MEDIUM* Overall ht. 5 $\frac{5}{8}$ (14.3) Inside ht. 4 $\frac{3}{16}$ (11)	52727	52718	52693	52710	52812	52714	52722	ONE RISER ONE FULL DIVIDER ONE TRIM DIVIDER
MEDIUM PLUS* Overall ht. 6 $\frac{3}{8}$ (16.2) Inside ht. 4 $\frac{3}{16}$ (12.2)	52761	52767	52702	52773	52813	52779	52817	
TALL Overall ht. 7 (17.8) Inside ht. 5 $\frac{5}{16}$ (14.4)	52728	52719	52703	52711	52816	52715	52723	TWO RISERS TWO DIVIDERS
TALL PLUS Overall ht. 7 $\frac{3}{4}$ (19.7) Inside ht. 6 $\frac{1}{4}$ (15.9)	52762	52768	52704	52774	52817	52780	52786	
X TALL* Overall ht. 8 $\frac{1}{2}$ (21.6) Inside ht. 7 $\frac{1}{8}$ (18.1)	52730	52720	52706	52712	52832	52716	52724	THREE RISERS TWO FULL DIVIDERS ONE TRIM DIVIDER
X TALL PLUS* Overall ht. 9 $\frac{1}{4}$ (23.5) Inside ht. 7 $\frac{1}{16}$ (19.5)	52763	52769	52707	52775	52844	52781	52787	
XX TALL Overall ht. 9 $\frac{7}{8}$ (25.1) Inside ht. 8 $\frac{1}{2}$ (21.6)	52729	52721	52708	52713	52845	52717	52725	FOUR RISERS THREE FULL DIVIDERS
XX TALL PLUS Overall ht. 10 $\frac{5}{16}$ (26.8) Inside ht. 9 $\frac{1}{16}$ (23)	52764	52770	52709	52776	52846	52782	52788	
XXX TALL* Overall ht. 11 $\frac{1}{16}$ (28.7) Inside ht. 9 $\frac{9}{16}$ (25.2)	52731	52732	52754	52733	52847	52734	52735	FIVE RISERS THREE FULL DIVIDERS ONE TRIM DIVIDER
XXX TALL PLUS* Overall ht. 12 $\frac{1}{8}$ (30.8) Inside ht. 10 $\frac{3}{16}$ (26.8)	52765	52771	52755	52777	52848	52783	52789	
XXXX TALL Overall ht. 12 $\frac{3}{4}$ (32.4) Inside ht. 11 (28.9)	52736	52737	52757	52738	52849	52739	52740	SIX RISERS FOUR FULL DIVIDERS

*Requires trimmed divider

Note: Trim dividers are used with one riser. Full dividers are used with two risers.



TRAEX® FLATWARE RACKS



HR2A

Traex Flatware Racks

- Mesh bottom prevents flatware from falling through
- Overall dimensions: 10" x 19¼" (25.4 x 50.2 cm)



ITEM #	DESCRIPTION	INSIDE COMPARTMENT	OVERALL HEIGHT: IN (CM)	INSIDE HEIGHT: IN (CM)	CASE LOT	COLOR
HR2A	Flatware half-rack w/1 extender	9 x 18¾ (22.9 x 46)	3¾ (9.7)	3 (7.7)	6	 32

Traex Flatware Soak & Washing System

- Allows pre-soak, wash, and transport for faster handling and less labor
- Rack's tight mesh bottom keeps flatware in place with free-flow solution
- Rack transfers directly to dishwasher



ITEM #	DESCRIPTION	DIMENSIONS (L X W X H): IN (CM)	CASE LOT	COLOR
1303	Half-rack soak system – Traex 4-compartment w/handles and half-tub	24½ x 13¾ x 5¼ (62.2 x 34 x 13.3)	1	 32
1392	Half-rack only, 4-compartment, no handles	19¾ x 10 x 3¾ (50 x 25. 9.7)	1	
1394	Half-tub and Traex 4-compartment rack, no handles	24½ x 13¾ x 5¼ (62.2 x 34 x 13.3)	1	
1393	Half-tub and Traex open rack	24½ x 13¾ x 5¼ (62.2 x 34 x 13.3)	1	
1397	Full-tub and Traex open rack	24½ x 24¾ x 5¼ (62.2 x 61.9 x 13.3)	1	
TR2	Full-size flatware racks	19¾ x 19¾ x 4 (50 x 50 x 10.2)	6	
HR2A	Traex flatware half-rack w/extender	19¾ x 10 x 3¾ (50 x 25.4 x 9.7)	6	
1300	Traex half-rack open w/handles	19¾ x 10 x 3¾ (50 x 25.4 x 9.7)	1	
1301	Half-rack, 4-compartment, w/handles	19¾ x 10 x 3¾ (50 x 25.4 x 9.7)	1	
1390	Traex half-tub only	24½ x 13¾ x 5¼ (62.2 x 34 x 13.3)	1	
1395	Traex full-size tub only	24 x 24¾ x 5¼ (61 x 61.9 x 13.3)	1	

Traex 8-Compartment Flatware Baskets

- Two baskets fit in full-size open rack
- Inside compartment: 3¾" x 3¾" x 4¼" (9 x 9 x 10.8 cm)



1372

1371

ITEM #	DESCRIPTION	INSIDE COMPARTMENT	OVERALL HEIGHT: IN (CM)	INSIDE HEIGHT: IN (CM)	CASE LOT	COLOR
1371	Traex basket w/out handles	3½ x 3½ (8.9 x 8.9)	5 (14.9)	4 (10.8)	6	 32
1372	Traex basket w/handles	3½ x 3½ (8.9 x 8.9)	5 (14.9)	4 (10.8)	6	

Traex® Silverware Cutlery Boxes

- Heavy-duty plastic with four rounded compartments
- May also use for storing packaged straws and condiment packets



1375

ITEM #	DESCRIPTION	DIMENSIONS (L X W X H): IN (CM)	CASE LOT
1375-01	Traex Chocolate	20 ⁷ / ₈ x 12 ⁷ / ₈ x 4 ¹ / ₂ (53 x 32.5 x 11.4)	12
1375-06	Traex Black	20 ⁷ / ₈ x 12 ⁷ / ₈ x 4 ¹ / ₂ (53 x 32.5 x 11.4)	12
1375-31	Traex Grey	20 ⁷ / ₈ x 12 ⁷ / ₈ x 4 ¹ / ₂ (53 x 32.5 x 11.4)	12

Traex Vertical Flatware Washing System, Cylinders & Storage

- Heavy-duty, long-wearing
- Vertical washing and drying is preferred for flatware



1370

HR1370

HR2D1DDA

ITEM #	DESCRIPTION	DIMENSIONS: IN (CM)	CASE LOT	COLOR
1370*	Traex flatware cylinder – beige plastic	4 ¹ / ₂ dia x 5 ⁵ / ₈ (11.4 dia x 14.3)	36	 32
HR1370*	Traex half rack with 8 flatware cylinders	19 ³ / ₄ x 10 x 9 ⁵ / ₁₆ (50 x 25.4 x 23)	3	
HR2D1DDA*	Traex 17-compartment half rack	19 ³ / ₄ x 10 x 9 ⁵ / ₁₆ (50 x 25.4 x 23)	2	

Traex Hold-Down Grid

- Vinyl coating
- Fits snugly on Traex full-size racks to keep small objects in place during washing, even under high pressure



TR13AW

ITEM #	DESCRIPTION	DIMENSIONS (L X W): IN (CM)	INSIDE HEIGHT	CASE LOT	COLOR
TR2W	Traex TR2 full-size rack w/hold-down grid (assembled)	19 ³ / ₄ x 19 ³ / ₄ (50 x 50)	3 ³ / ₄	1	 32
TR13AW	Traex TR13A full-size rack w/hold-down grid (assembled)	19 ³ / ₄ x 19 ³ / ₄ (50 x 50)	2 ¹ / ₁₆	1	
92241	Traex full-size grid only	17 ¹ / ₈ X 17 ¹ / ₈ (45.4 X 45.4)	–	1	

Traex Rack-Master® Ice Filler

- Gravity-fed system fills glassware in seconds
- Fits all 19³/₄" x 19³/₄" (50 x 50 cm) full-size warewashing racks
- 1⁷/₁₆" (6.4 cm) deep



TRICE25

TRICE25 shown with rack – sold separately

ITEM #	DESCRIPTION	CASE LOT	COLOR
TRICE16	Ice filler – 16-compartment	3	 32
TRICE25	Ice filler – 25-compartment	3	
TRICE36	Ice filler – 36-compartment	3	

TRAEX® BUS BOXES & COVERS

Traex Bus Boxes

- Reinforced ribs on the top and bottom add strength for extended life
- Stacking lugs prevent sticking together and allow for quicker drying
- Reinforced handles
- Made of high-density polyethylene
- Withstands temperatures between -30° and 180°F
- Traex boxes are approved for food contact



1527-01



1529-31



1521-05



1721-31

ITEM #	DESCRIPTION	COLOR	DIMENSIONS (L X W X H): IN (CM)	CASE LOT	COLORS*
1527-XX*	Standard 7" deep single-compartment bus box	Choose	21¼ x 15½ x 7 (55.2 x 39.4 x 17.8)	12	
1527B-XX*	Standard 7" deep single-compartment bus box	Choose	21¼ x 15½ x 7 (55.2 x 39.4 x 17.8)	150	01 05
1521-XX*	5" deep single-compartment bus box	Choose	21¼ x 15½ x 5 (55.2 x 39.5 x 12.7)	24	
1521B-XX*	5" deep single-compartment bus box	Choose	21¼ x 15½ x 5 (55.2 x 39.5 x 12.7)	150	06 31
1721-XX*	Two-compartment bus box	Gray and brown only	22¾ x 17¾ x 6½ (58.1 x 45.1 x 15.6)	12	
1529-31**	Undercounter bus box	Gray	23½ x 12 x 5¼ (59.7 x 30.5 x 13.7)	6	

*Add two-digit suffix (XX) after dash (-) to denote color **Not NSF® certified

Traex Bus Box Covers

- Item 1500-xx is available in white (05), clear (13), and grey (31) – fits 1521-xx and 1527-xx with a snap-fit design
- 1522-xx available in brown (01), white (05), black (06), and grey (31) – fits 1521-xx and 1527-xx and sits recessed on the box



1522-31



1500-05

ITEM #	DESCRIPTION	COLOR	DIMENSIONS (L X W X H): IN (CM)	CASE LOT	COLORS
1500-xx	Traex snap-on cover	Choose	22½ x 15½ x 2½ (56.2 x 39.7 x 6.4)	6	
1522-xx	Traex bus box cover	Choose	20 x 15 (50.8 x 38.1)	12	01 05

Cup Max™ & Glass Max™ Stackers

- Cup Max stacker accommodates cups with minimum 3" inside diameter, maximum 3½" outside diameter, maximum 2¾" base diameter
- Glass Max stacker accommodates glasses with minimum 2" inside diameter, maximum 3¼" outside diameter, maximum 21¼" base diameter



GS15-32



CS21-32

ITEM #	DESCRIPTION	DIMENSIONS (L X W): IN (CM)	CAPACITY	CASE LOT
CS15-32	Cup Max stacker	18 x 14 (45.7 x 35.6)	15 cups	6
GS21-32	Glass Max stacker	18 x 14 (45.7 x 35.6)	21 glasses	6

TRAEX® DOLLIES & DISH CADDIES

Traex Adjustable Dish Caddy

- Unique “easy adjustment” from the top
- Dual side handles for easy maneuvering
- Dish caddies have 19" of stacking space and allow approximately 40-55 plates per stack based on average plate height. Please calculate using your specific plate measurements for a more exact measurement.
- ADC units accommodate round pieces 4½" to 12½" (11.4 to 31.6 cm)
- SAC units accommodate:
 - Square pieces 4" to 10⅝" (10.2 to 27 cm)
 - Round pieces from 4" to 14" (10.2 to 35.6 cm)
 - Rectangular trays up to 14¼" x 9⅞" (36.2 x 25.1 cm)
- Empty SAC units stack together to save space
- Rotational molded body
- Vinyl cover included
- Color: SAC-black, ADC-grey



See page 251 for school compartment trays



Unique "Easy Adjustment" from the top



Empty SAC units stack together to save space

ITEM #	DISH SIZE: IN (CM)	STACKS	DIMENSIONS (H X W X L): IN (CM)	DIVIDERS	CASE LOT
ADC-2	11⅝" to 12½" (29.5 to 31.6) round plates	4	31⅞ x 30⅜ x 40 (78.9 x 76.7 x 101.6)	2	1
ADC-4	10¾" to 11½" (27.3 to 29.2) round plates	5	31⅞ x 30⅜ x 40 (78.9 x 76.7 x 101.6)	4	1
ADC-6	8⅞" to 9⅞" (21.9 to 23.2) round plates or 9⅞" to 10⅞" (23.2 to 27) round plates	6 or 5	31⅞ x 30⅜ x 40 (78.9 x 76.7 x 101.6)	6	1
ADC-8	7⅞" to 8½" (18.1 to 21.6) round plates	8	31⅞ x 30⅜ x 40 (78.9 x 76.7 x 101.6)	8	1
ADC-10	5½" to 7⅞" (14 to 18.1) round plates	9	31⅞ x 30⅜ x 40 (78.9 x 76.7 x 101.6)	10	1
ADC-14	4½" to 5½" (11.4 to 14) round plates	13	31⅞ x 30⅜ x 40 (78.9 x 76.7 x 101.6)	14	1
SAC-SQ1	9⅞" to 10⅞" (24.4 to 27) square plates/bowls	4	30½ x 27½ x 32¾ (77.5 x 69.9 x 83.2)	1	1
SAC-SQ4	8" to 9½" (20.3 24.1) square plates/bowls	4	30½ x 27½ x 32¾ (77.5 x 69.9 x 83.2)	4	1
SAC-SQ1A	14¼" to 9⅞" (36.2 to 25.1) trays	4	30½ x 27½ x 32¾ (77.5 x 69.9 x 83.2)	1	1
SAC-SQ5	4" to 8" (10.2 X 20.3) square plates/bowls	4	30½ x 27½ x 32¾ (77.5 x 69.9 x 83.2)	5	1
SAC-2	10⅞" to 11¼" (26.4 to 28.6) round plates/bowls	4	30½ x 27½ x 32¾ (77.5 x 69.9 x 83.2)	2	1
SAC-2A	12½" to 14" (31.6 to 35.6) round bowls/trays	2	30½ x 27½ x 32¾ (77.5 x 69.9 x 83.2)	2	1
SAC-4A	8½" to 9½" (21.6 to 24.1) round plates/bowls	4	30½ x 27½ x 32¾ (77.5 x 69.9 x 83.2)	4	1
SAC-4C	9⅞" to 10¼" (24.4 to 26) round plates/bowls	4	30½ x 27½ x 32¾ (77.5 x 69.9 x 83.2)	4	1
SAC-4D	11½" to 12½" (29.2 to 31.6) round plates/bowls	2	30½ x 27½ x 32¾ (77.5 x 69.9 x 83.2)	4	1
SAC-6	4" to 8" (10.2 X 20.3) round plates/bowls	6	30½ x 27½ x 32¾ (77.5 x 69.9 x 83.2)	6	1

Note: ADC color: grey SAC color: black

Replacement Parts for ADC & SAC Dish Caddies

ITEM #	DESCRIPTION	CASE LOT
ADP	Replacement post	1
SAVC	Replacement cover small	1
ADVC	Replacement cover large	1

Traex® Adjustable Dish Caddy Configurations

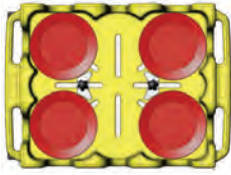

ADC-2

- 4 stacks holds: 11 $\frac{5}{8}$ "-12 $\frac{1}{2}$ " plates
- 2 post dividers
- L40 W30 H31 $\frac{1}{16}$



ADC-4

- 5 stacks holds: 10 $\frac{3}{4}$ "-11 $\frac{1}{2}$ " plates
- 4 post dividers
- L40 W30 H31 $\frac{1}{16}$

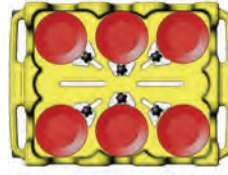

ADC-6

- 6 stacks holds: 8 $\frac{5}{8}$ "-9 $\frac{1}{8}$ " plates or 5 stacks holds 9 $\frac{1}{8}$ "-10 $\frac{5}{8}$ " plates
- 6 post dividers
- L40 W30 H31 $\frac{1}{16}$



SAC-2

- 4 stacks holds: 10 $\frac{3}{8}$ "-11 $\frac{1}{4}$ " round plates/bowls
- 2 post dividers
- L32 $\frac{3}{4}$ W27 $\frac{1}{2}$ H30 $\frac{1}{2}$



ADC-8

- 8 stacks holds: 7 $\frac{1}{8}$ "-8 $\frac{1}{2}$ " plates
- 8 post dividers
- L40 W30 H31 $\frac{1}{16}$

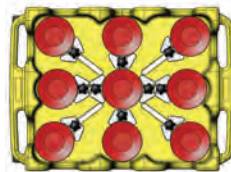

ADC-10

- 9 stacks holds: 5 $\frac{1}{2}$ "-7 $\frac{1}{8}$ " plates
- 10 post dividers
- L40 W30 H31 $\frac{1}{16}$

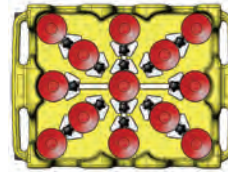

ADC-14

- 13 stacks holds: 4 $\frac{1}{2}$ "-5 $\frac{1}{2}$ " plates
- 14 post dividers
- L40 W30 H31 $\frac{1}{16}$

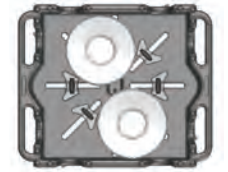

SAC-4D

- 2 stacks holds: 11 $\frac{1}{2}$ "-12 $\frac{1}{2}$ " round plates/bowls
- 4 post dividers
- L32 $\frac{3}{4}$ W27 $\frac{1}{2}$ H30 $\frac{1}{2}$



SAC-2A

- 2 stacks holds: 12 $\frac{1}{2}$ "-14" round bowls & trays
- 2 post dividers
- L32 $\frac{3}{4}$ W27 $\frac{1}{2}$ H30 $\frac{1}{2}$



SAC-4A

- 4 stacks holds: 8"-9 $\frac{1}{2}$ " round plates/bowls
- 4 post dividers
- L32 $\frac{3}{4}$ W27 $\frac{1}{2}$ H30 $\frac{1}{2}$



SAC-4C

- 4 stacks holds: 9 $\frac{5}{8}$ "-10 $\frac{1}{4}$ " round plates/bowls
- 4 post dividers
- L32 $\frac{3}{4}$ W27 $\frac{1}{2}$ H30 $\frac{1}{2}$



SAC-6

- 6 stacks holds: 4"-8" round plates/bowls
- 6 post dividers
- L32 $\frac{3}{4}$ W27 $\frac{1}{2}$ H30 $\frac{1}{2}$



SAC-SQ1

- 4 stacks holds: 9 $\frac{5}{8}$ " 10 $\frac{5}{8}$ " square plates/bowls
- 1 non-adjustable post divider
- L32 $\frac{3}{4}$ W27 $\frac{1}{2}$ H30 $\frac{1}{2}$



SAC-SQ4

- 4 stacks holds: 8"-9 $\frac{1}{2}$ " square plates/bowls
- 4 post dividers
- L32 $\frac{3}{4}$ W27 $\frac{1}{2}$ H30 $\frac{1}{2}$



SAC-SQ5

- 4 stacks holds: 4"-8" square plates/bowls
- 5 post dividers
- L32 $\frac{3}{4}$ W27 $\frac{1}{2}$ H30 $\frac{1}{2}$

SAC-SQ1A

- 4 stacks holds: trays up to 14 $\frac{1}{4}$ " x 9 $\frac{7}{8}$ "
- 1 post divider
- L32 $\frac{3}{4}$ W27 $\frac{1}{2}$ H30 $\frac{1}{2}$

Traex® Rack Dollies and Covers

- Constructed of impact-resistant copolymer with reinforced caster mounts and a rib-reinforced base
- 5" casters and optional handles for superior performance
- Hold loads up to 350 lbs
- Optional ½" (1.3 cm) hole for drainage
- Chrome-plated handle
- Handle sold separately



1697-06-LC2



1697-44



TRCV3



ITEM #	DESCRIPTION	DIMENSIONS: IN (CM)	RECOMMENDED HANDLE	CASE LOT
1697-32	Beige rack dolly base	21 x 21 (53 x 53)	1698	1
1697-02	Red rack dolly base	21 x 21 (53 x 53)	1698	1
1697-44	Blue rack dolly base	21 x 21 (53 x 53)	1698	1
1697-06	Recycled black rack dolly base	21 x 21 (53 x 53)	1698	1
1697-06-LC2	Recycled black rack dolly base w/2 locking casters	21 x 21 (53 x 53)	1698	1
1697-32-LC2	Recycled beige rack dolly base w/2 locking casters	21 x 21 (53 x 53)	1698	1
1698	Rack dolly handle	30 x 20½ (76.2 x 52.1)	–	1
TRCV3	Vinyl rack cover	36 x 21½ x 21½ (91.4 x 54.6 x 54.6)	–	3
TRCV4	Vinyl rack cover	48 x 21½ x 21½ (121.9 x 54.6 x 54.6)	–	3

Traex Rack Covers

- Open-design top eliminates water pooling
- Ideal for glass storage
- Covers fit all Vollrath racks and those of most major competitors



TR13



TR33

ITEM #	DESCRIPTION	DIMENSIONS (L X W X H): IN (CM)	CASE LOT
TR13	Open rack cover	19¾ x 19¾ x 1⅞ (50 x 50 x 3.7)	6
TR33	Solid rack cover	19¾ x 19¾ x 1⅞ (50 x 50 x 3.7)	6

TR13 and TR33 cannot be imprinted

Steel Rack Dolly

- Constructed from heavy-gauge steel
- Holds full-size racks
- Zinc-plated carbon steel dolly absorbs shock
- Use as a can dolly or stacked-chair dolly
- 4" (10.2 cm) non-marking casters
- Overall height: with handle 33" (83.8 cm); dolly only: 5⅞" (14.9 cm)
- Weight capacity: 200 lbs (90 kg)
- Handle sold separately



ITEM #	DESCRIPTION	GAUGE	PLATFORM DIMENSIONS (L X W): IN (CM)	CASE LOT
97190	Dolly without handle	12	20½ x 20½ (52.1 x 52.1)	1
97191	Handle only, chrome plated	18	–	1

TRAEX® COMPONENT PARTS

Full-Size Glass and Cup Extenders

OPEN- & CLOSED-WALL DESIGNS

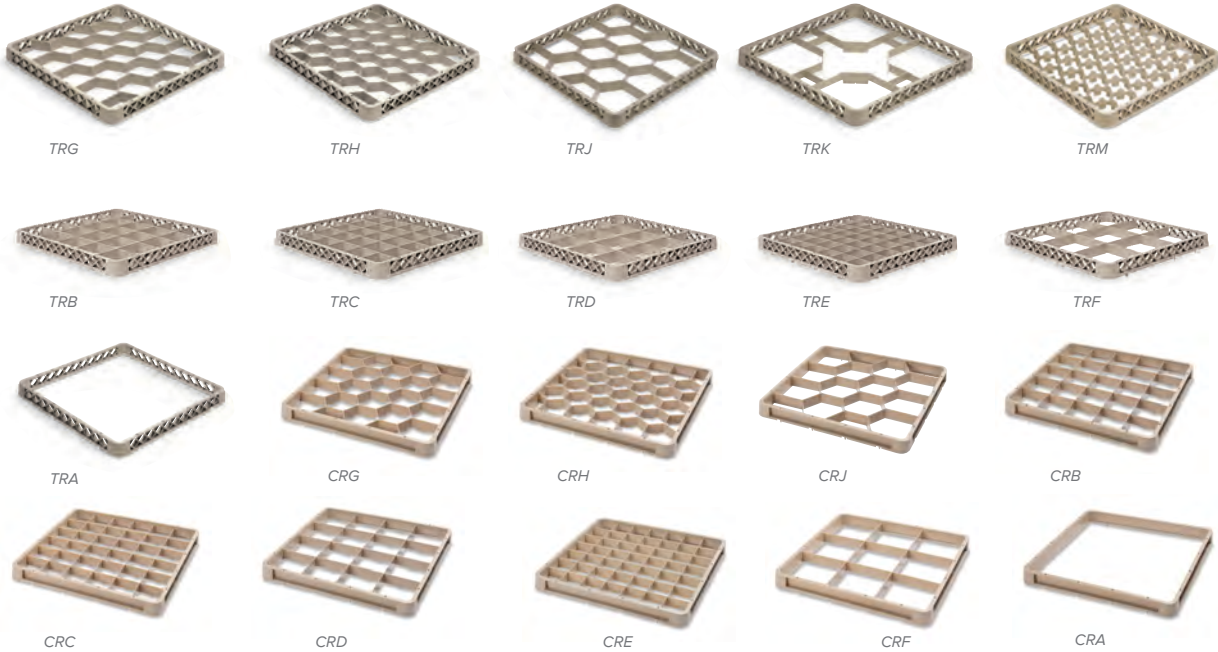

OPEN-WALL ITEM #	CLOSED-WALL ITEM #	DESCRIPTION	DIMENSIONS (H X W X L): IN (CM)	COMPARTMENT SIZE: IN (CM)	MAX HEIGHT IN (CM)	CASE LOT
RACK MAX® FULL-SIZE GLASS AND CUP EXTENDERS						
TRG	CRG	20-compartment extender	1 ¹ / ₁₆ x 19 ³ / ₄ x 19 ³ / ₄ (4 x 50 x 50)	3 ⁵ / ₁₆ (10) hexagon	1 ¹ / ₁₆ (4)	12
TRH	CRH	30-compartment extender	1 ¹ / ₁₆ x 19 ³ / ₄ x 19 ³ / ₄ (4 x 50 x 50)	3 ³ / ₁₆ (8) hexagon	1 ¹ / ₁₆ (4)	12
TRJ	CRJ	12-compartment extender	1 ¹ / ₁₆ x 19 ³ / ₄ x 19 ³ / ₄ (4 x 50 x 50)	4 ¹ / ₁₆ (12.2) hexagon	1 ¹ / ₁₆ (4)	12
TRK	–	5-compartment extender	1 ¹ / ₁₆ x 19 ³ / ₄ x 19 ³ / ₄ (4 x 50 x 50)	7 ¹ / ₂ (19)	1 ¹ / ₁₆ (4)	12
TRM	–	42-compartment extender	1 ¹ / ₁₆ x 19 ³ / ₄ x 19 ³ / ₄ (4 x 50 x 50)	2 ³ / ₄ (7) hexagon	1 ¹ / ₁₆ (4)	12
RACK-MASTER® FULL-SIZE GLASS AND CUP EXTENDERS						
TRB	CRB	25-compartment extender	1 ¹ / ₁₆ x 19 ³ / ₄ x 19 ³ / ₄ (4 x 50 x 50)	3 ¹ / ₂ (9) square	1 ¹ / ₁₆ (4)	12
TRC	CRC	36-compartment extender	1 ¹ / ₁₆ x 19 ³ / ₄ x 19 ³ / ₄ (4 x 50 x 50)	2 ⁵ / ₁₆ (7.5) square	1 ¹ / ₁₆ (4)	12
TRD	CRD	16-compartment extender	1 ¹ / ₁₆ x 19 ³ / ₄ x 19 ³ / ₄ (4 x 50 x 50)	4 ⁷ / ₁₆ (11.3) square	1 ¹ / ₁₆ (4)	12
TRE	CRE	49-compartment extender	1 ¹ / ₁₆ x 19 ³ / ₄ x 19 ³ / ₄ (4 x 50 x 50)	2 ¹ / ₂ (6.4) square	1 ¹ / ₁₆ (4)	12
TRF	CRF	9-compartment extender	1 ¹ / ₁₆ x 19 ³ / ₄ x 19 ³ / ₄ (4 x 50 x 50)	6" (15.3) square	1 ¹ / ₁₆ (4)	12
TRA	CRA	Open-compartment extender	1 ¹ / ₁₆ x 19 ³ / ₄ x 19 ³ / ₄ (4 x 50 x 50)	18 ¹ / ₁₆ (45.9) square	1 ¹ / ₁₆ (4)	12

COLORS

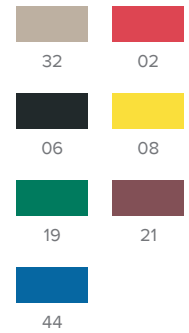

Closed-wall rack bases are only available in beige while extenders are available in all 7 colors.

Half-Size Glass and Cup Extenders



*Racks are made to order and cannot be returned.

ITEM #	DESCRIPTION	DIMENSIONS H X W X L IN (CM)	COMPARTMENT SIZE IN (CM)	MAX HEIGHT IN (CM)	CASE LOT	COLOR
HRA	Open extender	2 x 10 x 19 $\frac{3}{4}$ (5.1 x 25.4 x 50)	8 $\frac{3}{8}$ x 18 $\frac{1}{4}$ (21.3 x 46.5)	1 $\frac{1}{4}$ (4.4)	12	 32
HRB	8-compartment extender	2 x 10 x 19 $\frac{3}{4}$ (5.1 x 25.4 x 50)	4 $\frac{1}{8}$ X 4 $\frac{7}{16}$ (10.5 X 11.3)	1 $\frac{1}{4}$ (4.4)	12	
HRB1	8-compartment dropped extender	3 $\frac{1}{8}$ x 10 x 19 $\frac{3}{4}$ (7.9 x 25.4 x 50)	4 $\frac{1}{8}$ X 4 $\frac{7}{16}$ (10.5 X 11.3)	1 $\frac{1}{4}$ (4.4)	12	
HRC	10-compartment extender	2 x 10 x 19 $\frac{3}{4}$ (5.1 x 25.4 x 50)	3 $\frac{5}{8}$ x 4 $\frac{1}{4}$ (9.2 x 10.8)	1 $\frac{1}{4}$ (4.4)	12	
HRC1	10-compartment dropped extender	3 $\frac{1}{8}$ x 10 x 19 $\frac{3}{4}$ (7.9 x 25.4 x 50)	3 $\frac{5}{8}$ x 4 $\frac{1}{4}$ (9.2 x 10.8)	1 $\frac{1}{4}$ (4.4)	12	
HRD	17-compartment extender	2 x 10 x 19 $\frac{3}{4}$ (5.1 x 25.4 x 50)	2 $\frac{15}{16}$ (7.5) hexagon	1 $\frac{1}{4}$ (4.4)	12	
HRD1	17-compartment dropped extender	3 $\frac{1}{8}$ x 10 x 19 $\frac{3}{4}$ (7.9 x 25.4 x 50)	2 $\frac{15}{16}$ (7.5) hexagon	1 $\frac{1}{4}$ (4.4)	12	
HRF	17-compartment extender	2 x 10 x 19 $\frac{3}{4}$ (5.1 x 25.4 x 50)	3 (7.6) hexagon	1 $\frac{1}{4}$ (4.4)	12	
HR1	Open half-rack	9 x 18 $\frac{1}{16}$ (22.9 x 45.9)	2 $\frac{1}{16}$ (5.2)	1 $\frac{1}{4}$ (3.2)	12	
HR2	Flatware half-rack	9 x 18 $\frac{1}{16}$ (22.9 x 46)	2 $\frac{1}{16}$ (5.2)	1 $\frac{1}{4}$ (3.2)	12	

UTILITY CARTS

Heavy-Duty Stainless Steel Carts



- Extended-height stainless steel handles
- Frames and stainless shelves welded
- 1" (2.5 cm) square stainless tubular frame
- Two 5" (12.7 cm) swivel casters, one with brake
- Two 8" (20.3 cm) fixed wheels
- Ergonomic (raised lower shelf) and standard versions



ITEM #	DESCRIPTION	CAPACITY LB (KG)	SHELF SIZE (W X L): IN (CM)	MAXIMUM DIMENSIONS (L X W X H): IN (CM)	SHELF GAUGE	CASE LOT
TWO-SHELF CARTS WITH RAISED LOWER SHELF: HEIGHT BETWEEN SHELVES 18½" (46.9 CM)						
97200	2-shelf ergonomic	650 (295)	20 x 30 (50.7 x 76.1)	39 x 20 x 44½ (98.9 x 50.7 x 113)	16	1
97202	2-shelf ergonomic	900 (405)	23 x 35 (58.4 x 88.8)	44 x 23 x 44½ (112 x 58.4 x 113)	16	1
TWO-SHELF CARTS WITH STANDARD LOWER SHELF: HEIGHT BETWEEN SHELVES 30" (76.2 CM)						
97205	2-shelf standard	650 (295)	20 x 30 (50.7 x 76.1)	39 x 20 x 44½ (98.9 x 50.7 x 113)	16	1
97207	2-shelf standard	900 (405)	23 x 35 (58.4 x 88.8)	44 x 23 x 44½ (112 x 58.4 x 113)	16	1
THREE-SHELF CARTS WITH RAISED LOWER SHELF: HEIGHT BETWEEN SHELVES LOWER: 8⅞" (22.5 CM) UPPER: 7⅞" (19.9 CM)						
97201	3-shelf ergonomic	650 (295)	20 x 30 (50.7 x 76.1)	39 x 20 x 44½ (98.9 x 50.7 x 113)	16	1
97203	3-shelf ergonomic	900 (405)	23 x 35 (58.4 x 88.8)	44 x 23 x 44½ (112 x 58.4 x 113)	16	1
THREE-SHELF CARTS WITH STANDARD LOWER SHELF: HEIGHT BETWEEN SHELVES LOWER: 15" (38.1 CM) UPPER: 15" (38.1 CM)						
97206	3-shelf standard	650 (295)	20 x 30 (50.7 x 76.1)	39 x 20 x 44½ (98.9 x 50.7 x 113)	16	1
97208	3-shelf standard	900 (405)	23 x 35 (58.4 x 88.8)	44 x 23 x 44½ (112 x 58.4 x 113)	16	1
HEAVY-DUTY KNOCK-DOWN (K.D.) CART: HEIGHT BETWEEN SHELVES: LOWER: 10" (25.4 CM) UPPER: 10⅞" (25.6 CM)						
97211	3-shelf	650 (295)	20 x 30 (50.7 x 76.1)	37¾ x 21⅞ x 42¼ (95.9 x 53.7 x 107.3)	18	1

Note: For replacement part information, refer to VOLLRATH.com.

Caravelle Cart

- U-shaped tubular steel frame
- Capacity: 500 lb. (226.2 kg)
- Stainless steel drawn shelves
- 4" (10 cm) casters
- Shelves: 33" x 21" (85 x 54 cm)
- Height between shelves: 8½" (22 cm)



ITEM #	DESCRIPTION	MAXIMUM DIMENSIONS (L X W X H): IN (CM)	CASE WEIGHT: LBS (KG)	CASE LOT
97168	3-shelf tubular cart	37½ x 21 x 35½ (95 x 54 x 90)	56.6 (25.7)	1

Stainless Steel Assembled and Knocked-Down Utility Carts

- Heavy-duty welded construction
- Three stainless steel shelves
- ABS handle helps prevent damage to walls and doors
- Rated load capacity is weight distributed evenly on all shelves
- Swivel casters provide quiet and steady transport
- Height between shelves: 12" (30 cm) – 97140 is 12½" (31.3 cm)
- Knock-down design minimizes shipping costs



97320
(knocked down)



97320
(shown assembled)



97120

ITEM #	DESCRIPTION	CAPACITY LB (KG)	CASTER SIZE IN (CM)	MAXIMUM DIMENSIONS (L X W X H): IN (CM)	SHELF SIZE IN (CM)	CASE LOT
97120*	Medium-duty, assembled	300 (135)	3½ (9)	27½ x 15½ x 32½ (70 x 40 x 84)	15½ x 24 (39.4 x 60.9)	1
97121	Medium-duty, assembled	300 (135)	3½ (9)	30¾ x 17¾ x 33¾ (79 x 45 x 86)	17¾ x 27 (45 x 69)	1
97125	Heavy-duty, assembled	400 (180)	4 (10)	27½ x 15½ x 32½ (70 x 40 x 84)	15½ x 24 (39.4 x 60.9)	1
97126	Heavy-duty, assembled	400 (180)	4 (10)	30¾ x 17¾ x 33¾ (79 x 45 x 86)	17¾ x 27 (45 x 69)	1
97140	Extra-heavy-duty, assembled	500 (225)	4 (10)	39½ x 21 x 33¾ (100 x 54 x 84)	21 x 35 (54 x 90)	1
97320	Medium-duty, knocked-down	300 (135)	3½ (9)	27½ x 15½ x 32½ (70 x 40 x 84)	15½ x 24 (39.4 x 60.9)	1
97326	Heavy-duty, knocked-down	400 (180)	4 (10)	30¾ x 17¾ x 33¾ (79 x 45 x 86)	17¾ x 27 (45 x 69)	1

*Shippable via FedEx® or UPS® Note: For replacement part information, refer to VOLLRATH.com.

Money Saver Knocked-Down (K.D.) Cart

- Chrome-plated tubular frame
- Stainless steel 20-gauge shelves
- 4" (10 cm) casters provide quiet and steady transport
- Overall height: 36½" (92.7 cm)
- Height between shelves: 8½" (22 cm)
- Shippable via FedEx or UPS®



97105

ITEM #	DESCRIPTION	CAPACITY: LB (KG)	SHELF DIMENSIONS: IN (CM)	CASE WEIGHT: LBS (KG)	SHIPPING CUBE	CASE LOT
97105	3-shelf	400 (180)	24 x 16 (61 x 41)	36 (16.3)	1.904	1
97106	3-shelf	500 (225)	33 x 21 (85 x 54)	49.6 (22.5)	2.283	1

Note: For replacement part information, refer to VOLLRATH.com.

Plastic Enclosed Utility Cart

- Structural foam shelves
- Textured grey finish masks scratches and resists fading and discoloration
- 200 lb (90.7 kg) overall capacity
- 4" (10 cm) swivel casters provide quiet and steady transport
- Shelves: 29" x 18½" (74 x 47 cm)
- Shipped knocked down via FedEx® or UPS® to minimize shipping costs
- Plastic uprights
- Enclosed end panels
- Height between shelves: 10½" (26.7 cm)



97111

ITEM #	DESCRIPTION	MAXIMUM DIMENSIONS: IN (CM)	CASE LOT
97111	Closed-end utility cart	30½ x 18½ x 39 (78 x 47 x 99)	1

Open Utility Carts with Chrome Uprights

- Structural foam shelves
- Textured grey finish masks scratches and resists fading and discoloration
- 200 lb (90.7 kg) overall capacity
- 4" (10 cm) swivel casters provide quiet and steady transport
- Shelves: 29" x 18½" (74 x 47 cm)
- Shipped knocked down via FedEx® or UPS® to minimize shipping costs
- Mirror-finished, chrome-plated uprights and handle
- Height between shelves: 97101: 23½" (60 cm), 97102: 10½" (26.7 cm)



97102

97101

ITEM #	DESCRIPTION	MAXIMUM DIMENSIONS: IN (CM)	CASE LOT
97101	2-shelf utility cart	30½ x 18½ x 36 (78 x 47 x 92)	1
97102	3-shelf utility cart	30½ x 18½ x 36 (78 x 47 x 92)	1

Open Utility Carts with Plastic Uprights

- Structural foam shelves
- Textured grey finish masks scratches and resists fading and discoloration
- 200 lb (90.7 kg) overall capacity
- 4" (10 cm) swivel casters provide quiet and steady transport
- Shelves: 29" x 18½" (74 x 47 cm)
- Open four sides
- Height between shelves: 10½" (26.7 cm)



97112

ITEM #	DESCRIPTION	MAXIMUM DIMENSIONS: IN (CM)	CASE LOT
97112	Open utility cart	30½ x 18½ x 39 (78 x 47 x 99)	1

Note: For replacement part information, refer to VOLLRATH.com.

Bussing Carts

- Stainless steel construction
- ABS handle
- Attractive, durable black vinyl finish
- Enclosed on three sides
- Swivel casters provide quiet and steady transport



ITEM #	DESCRIPTION	CAPACITY LB (KG)	CASTER SIZE IN (CM)	MAXIMUM DIMENSIONS (L X W X H): IN (CM)	SHELF SIZE IN (CM)	HEIGHT BETWEEN SHELVES IN (CM)	CASE LOT
97180*	4-shelf	300 (135)	3½ (9)	27½ x 15½ x 33¾ (70 x 40 x 86)	24 x 15½ (61 x 39)	Top shelf – 8½ (21.6) Bottom shelf – 8 (20)	1
97181	3-shelf	300 (135)	4 (10)	30¾ x 17¾ x 33¾ (78 x 45 x 86)	27 x 17¾ (45 x 69)	12½ (31.7)	1
97182	3-shelf	500 (225)	4 (10)	39¾ x 21 x 34¾ (100 x 54 x 88)	35 x 21 (54 x 89)	12½ (31.7)	1

*Shippable via FedEx® or UPS® Note: For replacement part information, refer to VOLLRATH.com.

Thrift-I-Cart

- Chrome-plated tubular steel frame
- One-piece drawn stainless steel shelves
- 20-gauge shelves
- 4" (10 cm) swivel casters provide quiet and steady transport
- Overall height: 36½" (92.7 cm)
- Height between shelves:
 - 97160/61 – 19" (47.5 cm)
 - 97166/67 – 8⅞" (22.2 cm)



ITEM #	DESCRIPTION	CAPACITY LB (KG)	SHELF DIMENSIONS IN (CM)	CASE WEIGHT LBS (KG)	CASE LOT
97160	2-shelf	400 (180)	24 x 16 (61 x 41)	32.3 (14.7)	1
97166	3-shelf	400 (180)	24 x 16 (61 x 41)	37.7 (17.1)	1
97161*	2-shelf	500 (225)	33 x 21 (85 x 54)	25.4 (11.5)	1
97167	3-shelf	500 (225)	33 x 21 (85 x 54)	53.8 (24.4)	1

Cantilever Bussing Cart

- Chrome tubular steel frame
- Three-shelf cart holds up to three standard tote boxes
- 4" (10 cm) swivel casters provide quiet and steady transport
- Height between shelves: 13" (33 cm)
- Shippable via FedEx® or UPS®
- See pages 278 and 283 for bus boxes



ITEM #	DESCRIPTION	CAPACITY LB (KG)	MAXIMUM DIMENSIONS (L X W X H): IN (CM)	CASE WEIGHT LBS (KG)	CASE LOT
97186*	3-shelf	300 (135)	26¾ x 15¾ x 34½ (67.6 x 40 x 87.6)	31.9 (14.5)	1

*Not recommended for use with refuse bin

Multi-Purpose Carts

- Front-of-the-house appearance with back-of-the-house durability
- Polypropylene shelves and handles are durable and lightweight
- Satin-finished aluminum uprights are durable and minimize wear
- Textured shelves reduce product shifting in transit
- 4" (10.1 cm) swivel non-marking casters allow for easy maneuverability
- Easy to clean, store, and assemble
- Shipped knocked down via FedEx® or UPS®



97007
Bus boxes and refuse bins sold separately

BLACK ITEM #	BLUE-GREY ITEM #	CAPACITY LBS. (KG)	CASTER SIZE IN (CM)	MAXIMUM DIMENSIONS (L X W X H): IN (CM)	SHELF SIZE IN (CM)	HEIGHT BETWEEN SHELVES: IN (CM)	CASE LOT
97006	97004	300 (135)	4 (10)	33 x 16 ³ / ₁₆ x 37 (83.8 x 42.7 x 94)	16 ¹ / ₂ x 26 (41.3 x 66)	11 ¹ / ₄ (29.8)	1
97007	97005	300 (135)	4 (10)	40 ¹ / ₄ x 19 ¹ / ₈ x 37 (102.2 x 50.5 x 94)	19 ¹ / ₄ x 29 ¹ / ₂ (48.9 x 74.9)	11 ¹ / ₄ (29.8)	1

Note: For replacement part information, refer to VOLLRATH.com.

Complete Bussing System Kit

- Kit includes one refuse bin, one silver bin, and three bus boxes (52612)



ITEM #	DESCRIPTION	CASE LOT
97286	Complete grey bussing system kit for standard carts	1

Refuse Bins

- High-density polyethylene
- Integral full-width hook fits over raised edge of cart top shelf or over cart handle



ITEM #	FITS	DIMENSIONS (L X W X H): IN (CM)	CASE LOT
9728810	Refuse bin, black	13 ¹ / ₂ x 8 x 22 ³ / ₄ (34.3 x 20.3 x 57.8)	6
9728820	Refuse bin, grey	13 ¹ / ₂ x 8 x 22 ³ / ₄ (34.3 x 20.3 x 57.8)	6

Silver Bins

- Fits all standard-size carts and trucks
- Dimensions: 15¹/₂" x 6³/₈" x 6¹/₂" (40 x 16 x 17 cm)



ITEM #	DESCRIPTION	CASE LOT
97280	Silver bin, grey	6
97290	Silver bin, black	6



DISPENSING SOLUTIONS

Maximize limited space and keep operations tidy at busy self-serve stations with the LidSaver™ dispenser and a full line of straw, condiment, tissue, napkin, and a variety of other dispensers.

DISPENSING SOLUTIONS

Lid & Cup Dispensers



Eliminate waste and reduce the potential for germs to spread with LidSaver™ dispensers. These simple-to-use designs keep counters free of lid stacks and cups.

Pages 296-301

Countertop Dispensers



Our versatile self-serve dispensers are ideal for condiment packets, flatware, and more.

Pages 301-304

Flush-Mount Dispensers & Organizers



Flush-mount dispensers and organizers are easy to install and mount flush into the face of your counter. They're ideal for self-serve areas to accommodate condiments, lids, straws, flatware, and more.

Pages 305-306

Napkin Dispensers



Choose from in-counter, countertop, and tabletop models in a variety of colors and designs.

Pages 307-308

Straw Dispensers



Reduce waste and save money with a patented dispensing mechanism that delivers just one straw at a time.

Page 309

 Visit VOLLRATH.com

**One LidSaver dispenser will
pay for itself within 6 months**



Based on reduced waste and reduced labor for clean-up on usage of 1,000 lids per week. Visit VOLLRATH.com/lidsaver2 for details.





LID & CUP DISPENSERS

LidSaver™ 2 Dispensers

IMPROVED DESIGN

- Smaller footprint to free up valuable counter space
- More stylish and attractive look to fit in with most décors

COST SAVINGS

- Fewer wasted lids adds up to more savings
- Counters are kept free of stacks of new lids and messy rejected lids, requiring less labor for cleanup

HYGIENIC SOLUTION

- Dispensing system helps eliminate contamination from excess handling
- Keeps operations clean and tidy, addressing major consumer concerns about health and well-being
- Simple-to-use design allows customers to fill beverages and grab a lid using only one hand
- Dispenses soda, coffee, and domed lids from 1¾" to 4¾" (4.4 to 12.1 cm)



Visit Vollrath's LidSaver Dispenser Item Builder at VOLLRATH.com/lidsaver2.



G2V-LL-(lid codes)



G58804-(lid codes)



G4V-LLCC-(lid codes)-A-A



Easier loading for lid sleeves with the new door hold-open feature.



ITEM #	DESCRIPTION	DIMENSIONS (L X W X H): IN (CM)	FOR LIDS WITH RIM DIAMETER: IN (CM)	CASE LOT
IN-COUNTER DISPENSERS				
LS02IB-(lid code)**	LidSaver 2, in-counter horizontal mount with black housing	26¾ x 5¾ x 6½ (67.1 x 14.7 x 15.5)	3¼-4 (8.3 x 10.2)	1
LS02PB-(lid code)**	LidSaver 2, in-counter horizontal mount with black housing	26¾ x 5 7/8 x 6 1/2 (67.1 x 15 x 16.5)	4 1/16-4 3/4 (10.3 x 12.1)	1
LS02IVB-(lid code)**	LidSaver 2 in-counter vertical mount w/black faceplate	26¾ x 5 7/8 x 6 1/2 (67.1 x 15 x 16.5)	3¼-4 (8.3 x 10.2)	1
LS02PVB-(lid code)**	LidSaver 2 in-counter vertical mount w/black faceplate	26¾ x 5 7/8 x 6 1/2 (67.1 x 15 x 16.5)	4 1/16-4 3/4 (10.3 x 12.1)	1
LS02IS18B-(lid code)**	LidSaver 2 in-counter shallow 18" horizontal mount, black faceplate	20¾ x 5 7/8 x 6 1/2 (67.1 x 15 x 16.5)	3¼-4 (8.3 x 10.2)	1
LS02PS18B-(lid code)**	In-counter shallow 18" horizontal mount, black faceplate	20¾ x 5 7/8 x 6 1/2 (67.1 x 15 x 16.5)	4 1/16-4 3/4 (10.3 x 12.1)	1

To complete item number, visit VOLLRATH.com to use the LidSaver 2 online configurator **NSF® certified

ITEM #	DESCRIPTION	DIMENSIONS (L X W X H): IN (CM)
CABINET STANDARD, BLACK HOUSING FOR LIDSAVER 2		
G1-L-(lid code)	Cabinet standard, black housing for LidSaver 2, contains 1 LidSaver 2	26½ x 7 7/8 x 8¾ (66 x 18 x 20.3)
G2V-LL-(lid code)-(lid code)	Cabinet standard vertical, black housing for LidSaver 2, contains 2 LidSaver 2	26½ x 7 7/8 x 16¾ (66 x 18 x 40.6)
G2H-LL-(lid code)-(lid code)	Cabinet standard, horizontal black housing for LidSaver 2, contains 2 LidSaver 2	26½ x 14¼ x 8¾ (66 x 35.6 x 20.3)
G2V-LC-(lid code)-A	Cabinet standard vertical, black housing for LidSaver 2, contains 1 LidSaver 2 and 1 INC80 cup dispenser	26½ x 7 7/8 x 16¾ (66 x 18 x 40.6)
G2V-LC-(lid code)-D	Cabinet standard vertical, black housing, contains 1 LidSaver 2 and 1- INC80 cup dispenser	26½ x 7 7/8 x 16¾ (66 x 18 x 40.6)
G3V-LLL-(lid code)-(lid code)-(lid code)	Cabinet standard vertical, black housing for LidSaver 2, contains 3 LidSaver 2	26½ x 7 7/8 x 24 (66 x 18 x 61)
G3H-LLL-(lid code)-(lid code)-(lid code)	Cabinet standard horizontal, black housing for LidSaver 2, contains 3 LidSaver 2	26½ x 21¾ x 8¾ (66 x 53.3 x 20.3)
G3V-LCC-(lid code)-A-A	Cabinet standard vertical, black housing for LidSaver 2, contains 1 LidSaver 2 and 2 INC80 cup dispensers	26½ x 7 7/8 x 24 (66 x 18 x 61)
G3V-LCS-(lid code)-A-S	Cabinet standard vertical, black housing for LidSaver 2, contains 1 LidSaver 2, 1 INC80 cup dispenser, and 1 straw pocket	26½ x 7 7/8 x 24 (66 x 18 x 61)
G4V-LLCC-(lid code)-(lid code)-A-A	Cabinet standard vertical, black housing for LidSaver 2, contains 2 LidSaver 2 and 2 INC80 cup dispensers	26½ x 7 7/8 x 31 5/8 (66 x 18 x 78.7)
G4V-4L-(lid code)-(lid code)-(lid code)-(lid code)	Cabinet standard vertical, black housing for LidSaver 2, contains 4 LidSaver 2	26½ x 7 7/8 x 31 5/8 (66 x 18 x 78.7)
G4X-4L-(lid code)-(lid code)-(lid code)-(lid code)	Cabinet standard 2 x 2, black housing for LidSaver 2, contains 4 LidSaver 2	26½ x 14¼ x 16¾ (66 x 35.6 x 40.6)
G58804-(lid code)-(lid code)	3 high x 2 wide ABS plastic cabinet with 3 INC80 cup dispensers, 2 LidSaver 2, and one straw pocket	26½ x 14¼ x 24 (66 x 35.6 x 61)
G58801-(lid code)-(lid code)-(lid code)	4 high x 2 wide ABS plastic cabinet with 4 INC80 cup dispensers, 3 LidSaver 2, and one straw pocket	26½ x 14¼ x 31 5/8 (66 x 35.6 x 78.7)
CABINET SHALLOW, BLACK HOUSING FOR LIDSAVER 2		
H1-L-(lid code)	Cabinet shallow, black housing for LidSaver 2 – contains 1 LidSaver 2	21 5/8 x 7 7/8 x 8¾ (53.3 x 18 x 20.3)
H2V-LL-(lid code)-(lid code)	Cabinet vertical shallow, black housing for LidSaver 2 – contains 2 LidSaver 2	21 5/8 x 7 7/8 x 16¾ (53.3 x 18 x 40.6)
H2V-LC-(lid code) -A	Cabinet vertical shallow, black housing for LidSaver 2 – contains 1 LidSaver 2 and 1-INC80 cup dispenser	21 5/8 x 7 7/8 x 16¾ (53.3 x 18 x 40.6)
H3V-LLL-(lid code)-(lid code)-(lid code)	Cabinet vertical shallow, black housing for LidSaver 2 – contains 3 LidSaver 2	21 5/8 x 7 7/8 x 24 (53.3 x 18 x 61)
H3V-LCC-(lid code)-A-A	Cabinet vertical shallow, black housing for LidSaver 2 – contains 1 LidSaver 2 and 2-INC80 cup dispensers	21 5/8 x 7 7/8 x 24 (53.3 x 18 x 61)
H4V-4L-(lid code)-(lid code)-(lid code)-(lid code)	Cabinet vertical shallow, black housing for LidSaver 2 – contains 4 LidSaver 2	21 5/8 x 7 7/8 x 31 5/8 (53.3 x 18 x 78.7)

*LidSaver 2 dispensers are made to order and cannot be returned.

LidSaver™ 2 Mini

- Same sanitary solution, cost savings, and customer benefits as LidSaver 2
- Smaller footprint takes up less valuable counter space
- Stylish presentation fits most decors
- Designed with a door hold-open feature for easy loading
- Ideal for portion lids and cups
- In-counter models can mount horizontally or vertically



LS02MS18B-__(lid code)

J2V-LL-__(lid code)-__(lid code)

ITEM #	DESCRIPTION	DIMENSIONS (W X D X H): IN (CM)	ACCOMMODATES CUPS/LIDS WITH RIM DIAMETER: IN (CM)	CASE LOT
LS02MS18B-__(lid code)*	LidSaver 2 Mini in-counter, horizontal mount. 18" (45.7 cm) L tube	4 ¹⁵ / ₁₆ W x 5 ⁵ / ₈ H (12.5 x 14.3)	1 ³ / ₄ -3 ¹ / ₄ (4.4 x 8.3) Diameter, with a max height of 1 ⁷ / ₈ (4.8)	1
LS02MVS18B-__(lid code)*	LidSaver 2 Mini in-counter, vertical mount. 18" (45.7 cm) L tube	4 ¹⁵ / ₁₆ W x 5 ⁵ / ₈ H (12.5 x 14.3)	1 ³ / ₄ -3 ¹ / ₄ (4.4 x 8.3) Diameter, with a max height of 1 ⁷ / ₈ (4.8)	1
J1-L-__(lid code)	LidSaver 2 Mini single high shallow narrow ABS plastic cabinet – includes 1 LidSaver 2 Mini	5 ¹ / ₄ x 21 ⁵ / ₈ x 7 ¹ / ₂ (13.3 x 54.9 x 19.1)	1 ³ / ₄ -3 ¹ / ₄ (4.4 x 8.3) Diameter, with a max height of 1 ⁷ / ₈ (4.8)	1
J2V-LL-__(lid code)-__(lid code)	LidSaver 2 Mini 2 high shallow narrow ABS plastic cabinet – includes 2 LidSaver 2	5 ¹ / ₄ x 21 ⁵ / ₈ x 14 ¹ / ₈ (13.3 x 54.9 x 35.9)	1 ³ / ₄ -3 ¹ / ₄ (4.4 x 8.3) Diameter, with a max height of 1 ⁷ / ₈ (4.8)	1
J2H-LL-__(lid code)-__(lid code)	LidSaver 2 Mini 2 wide shallow narrow ABS plastic cabinet – includes 2 LidSaver 2	11 ¹ / ₄ x 21 ⁵ / ₈ x 7 ¹ / ₂ (28.6 x 54.9 x 19.1)	1 ³ / ₄ -3 ¹ / ₄ (4.4 x 8.3) Diameter, with a max height of 1 ⁷ / ₈ (4.8)	1
J3V-LLL-__(lid code)-__(lid code)-__(lid code)	LidSaver 2 Mini 3 high shallow narrow ABS plastic cabinet – includes 3 LidSaver 2 Mini	5 ¹ / ₄ x 21 ⁵ / ₈ x 20 ⁵ / ₈ (13.3 x 54.9 x 52.4)	1 ³ / ₄ -3 ¹ / ₄ (4.4 x 8.3) Diameter, with a max height of 1 ⁷ / ₈ (4.8)	1

* NSF
To complete item number, visit VOLLRATH.com to use the LidSaver 2 online configurator.

Countertop LidSavers™ with Condiment Organizer

- Durable one-piece construction
- Accommodates straws up to 10¹/₄" L



G1LLDS-__(lid code)

G2VLCLDS-__(lid code)

ITEM #*	DESCRIPTION	DIMENSIONS (H X W X L): IN (CM)	CASE LOT
G1LLDS-__(lid code)	Single LidSaver 2 cabinet with condiment organizer	16 ³ / ₄ x 6 ¹ / ₂ x 25 ¹ / ₄ (42.5 x 17.4 x 64.1)	1
G2VLCLDS-__(lid code)-A	2-high cabinet, 1 LidSaver 2, 1 cup dispenser INC-80 with condiment organizer	23 ³ / ₄ x 6 ¹ / ₂ x 25 ¹ / ₄ (60.3 x 17.4 x 64.1)	1
C1LLDS-__(lid code)	Single LidSaver cabinet with condiment organizer	16 ³ / ₄ x 6 ¹ / ₂ x 25 ¹ / ₄ (42.5 x 17.4 x 64.1)	1
C2VLCLDS-__(lid code)-A	2-high cabinet, 1 LidSaver, 1 cup dispenser INC-80 with condiment organizer	23 ³ / ₄ x 6 ¹ / ₂ x 25 ¹ / ₄ (60.3 x 17.4 x 64.1)	1

*Not a complete item number – visit online configurator to determine complete item number. LidSavers are lid specific, and lid manufacturer and part number must be supplied when ordering LidSaver.

Visit VOLLRATH.com/ls2builder



Online Lidsaver 2 Dispenser Builder Tool

*LidSavers are made to order and cannot be returned.

Cup Dispensers

- Silicone molded gasket
- Easy attachable collar
- Durable construction
- 4 different sized gaskets to accommodate paper, plastic, and foam cups
- Accommodates lids up to 4⁷/₈"



2V-CC-A-A



G58807



ITEM #	DESCRIPTION	DIMENSIONS: L X W X H: IN (CM)	ACCOMMODATES CUPS/LIDS WITH RIM DIAMETER: IN (CM)	CASE LOT
CABINETS, CUP DISPENSERS				
1-C-A	Single-cabinet INC-80 cup dispenser	25 ¹ / ₄ x 8 ³ / ₄ x 7 ³ / ₈ (64.1 x 20.3 x 18.7)	2 ¹ / ₄ -4 ³ / ₄ (5.7-12.1)	1
2V-CC-A-A	2-high vertical cabinet, INC-80 cup dispenser	25 ¹ / ₄ x 16 ³ / ₈ x 14 ³ / ₈ (64.1 x 40.5 x 36.5)	2 ¹ / ₄ -4 ³ / ₄ (5.7-12.1)	1
3V-CCC-A-A-A	3-high vertical cabinet, INC-80 cup dispensers	25 ¹ / ₄ x 24 x 14 ³ / ₈ (64.1 x 61 x 36.5)	2 ¹ / ₄ -4 ³ / ₄ (5.7-12.1)	1
3V-CCS-A-A-A	3-high vertical cabinet, 2-INC-80 cup dispenser and straw pocket	25 ¹ / ₄ x 31 ⁵ / ₈ x 21 ⁵ / ₈ (64.1 x 79 x 54.2)	2 ¹ / ₄ -4 ³ / ₄ (5.7-12.1)	1
G58806	3 x 2 ABS plastic cabinet with 3 INC80 cup dispensers, 3 "T" holders, and one straw pocket	25 ¹ / ₄ x 14 ¹ / ₄ x 21 ³ / ₈ (64.1 x 36.1 x 54.2)	2 ¹ / ₄ -4 ³ / ₄ (5.7-12.1)	1
G58807	4 x 2 ABS plastic cabinet with 4 INC80 cup dispensers, 4 "T" holders, and one straw pocket	25 ¹ / ₄ x 14 ¹ / ₄ x 28 ³ / ₈ (64.1 x 36.1 x 72)	2 ¹ / ₄ -4 ³ / ₄ (5.7-12.1)	1

Additional models and cabinets available at VOLLRATH.com

In-Counter Cup Dispensers

PLASTIC DISPENSERS

- Molded silicone gasket for easy cup release
- Easy attachable collar
- Durable construction
- 4 different-sized gaskets come with each unit to accommodate paper, plastic, or foam cups
- Mounts horizontally or vertically

NEW STAINLESS STEEL DISPENSERS

- Easy dial adjustment
- Each stainless steel unit comes with 2 springs: 1 standard spring for paper and plastic cups and 1 lighter spring for foam cups
- Stainless steel grips ensure one-at-a-time dispensing
- Mounts horizontally or vertically
- See our Serving Systems and Components brochure for more in-counter LidSaver dispensers



INC-80



CADJ-3



ITEM #	DESCRIPTION	DIMENSIONS (L X W): IN (CM)	ACCOMMODATES CUPS WITH RIM DIAMETER: IN (CM)	CASE LOT
GASKET STYLE DISPENSERS				
INC-80	Gasket-style cup dispenser, 23" (58.4 cm) L	24 ³ / ₈ x 6 ¹ / ₂ (62.2 x 16.5)	2 ¹ / ₄ -4 ³ / ₄ (5.7-12.1)	1
INC-80S18	Gasket-style cup dispenser, 18" (45.7 cm) L	19 ¹ / ₄ x 6 ¹ / ₂ (49.5 x 16.5)	2 ¹ / ₄ -4 ³ / ₄ (5.7-12.1)	1
STAINLESS STEEL DISPENSERS				
CADJ-1	In-counter adjustable stainless steel cup dispenser, 22"	22 x 5.4 (55.9 x 13.7)	2 ¹ / ₂ -3 ¹ / ₂ (6.4-8.9)	1
CADJ-2	In-counter adjustable stainless steel cup dispenser, 22"	22 x 5.4 (55.9 x 13.7)	3-3 ⁷ / ₈ (7.6-9.8)	1
CADJ-3	In-counter adjustable stainless steel cup dispenser, 22"	22 x 5.4 (55.9 x 13.7)	3-4 ⁵ / ₈ (7.6-11.7)	1
CADJ-4	In-counter adjustable stainless steel cup dispenser, 22"	22 x 5.4 (55.9 x 13.7)	4 ¹ / ₂ -5 ¹ / ₄ (11.4-13.3)	1

Additional models and cabinets available at VOLLRATH.com.

Wall-Mount LidSavers and Cup Dispensers

- Wall-mount unit frees up valuable counter space
- Mounting hardware included



C1VW

1VW-A

ITEM #*	DESCRIPTION	DIMENSIONS (H X W X L): IN (CM)	CASE LOT
C1VW-(LID CODE)	Wall-mount, single-cabinet vertical LidSaver	7 ¹ / ₈ x 7 ³ / ₈ x 25 ¹ / ₄ (18.1 x 18.7 x 64.1)	1
1VW-A	Wall-mount, single-cabinet gasket-style vertical cup dispenser INC-80	7 ¹ / ₈ x 7 ³ / ₈ x 25 ¹ / ₄ (18.1 x 18.7 x 64.1)	1

**Not a complete item number – visit online configurator to determine complete item number. LidSavers are lid specific, and lid manufacturer and part number must be supplied when ordering LidSaver.*

NEW Stainless Steel Dispenser Cabinets

- Durable stainless steel construction
- Maximize counter space with vertical cabinets
- Easy way to organize cups, lids, and straws
- Available with the INC-80 gasket cup dispenser or the CADJ-3 adjustable stainless steel cup dispenser
- LidSaver™ 2 provides a sanitary solution and cost savings
- INC80 and CADJ3 dispensers are NSF certified
- Accommodates lids up to 47/8"
- CADJ units come with 2 springs: 1 standard spring for paper and plastic cups and 1 lighter spring for foam cups



ITEM #	DESCRIPTION	DIMENSIONS (H X W X D): IN (CM)	CASE LOT
STAINLESS STEEL CUP DISPENSER CABINETS WITH INC-80 GASKET STYLE CUP DISPENSER			
58821-A	1 single-cabinet INC-80 cup dispensers	8¾ x 7½ x 23¼ (22.2 x 18.1 x 59.1)	1
58822-A-A	2-high vertical INC-80 cup dispensers	16¾ x 7½ x 23¼ (41.6 x 18.1 x 59.1)	1
58823-A-A-A	3-high vertical INC-80 cup dispensers	24 x 7½ x 23¼ (61 x 18.1 x 59.1)	1
58824-A-A-A-A	4-high vertical INC-80 cup dispensers	31½ x 7½ x 23¼ (80.3 x 18.1 x 59.1)	1
58834	4 x 2 cabinet 4- INC-80 cup dispensers and 3- "T" holders with straw	31½ x 14¼ x 23¼ (80.3 x 36.2 x 59.1)	1
58833	3 x 2 cabinet 3- INC-80 cup dispensers and 2- "T" lids with straw	24 x 14¼ x 23¼ (61 x 36.2 x 59.1)	1
58832	2 x 2 cabinet, 2- INC-80 cup dispensers and 1- "T" lids with straw	16¾ x 14¼ x 23¼ (41.6 x 36.2 x 59.1)	1
STAINLESS STEEL CUP DISPENSER CABINETS WITH THE CADJ-3 STAINLESS STEEL CUP DISPENSERS			
58821-D	1 single cabinet CADJ-3 cup dispensers	8¾ x 7½ x 23¼ (22.2 x 18.1 x 59.1)	1
58822-D-D	2-high vertical CADJ-3 cup dispensers	16¾ x 7½ x 23¼ (41.6 x 18.1 x 59.1)	1
58823-D-D-D	3-high vertical CADJ-3 cup dispensers	24 x 7½ x 23¼ (61 x 18.1 x 59.1)	1
58824-D-D-D-D	4-high vertical CADJ-3 cup dispensers	31½ x 7½ x 23¼ (80.3 x 18.1 x 59.1)	1
58842	3 x 2 cabinet 3- CADJ-3 cup dispensers and 2 "T" lids with straw	24 x 14¼ x 23¼ (61 x 36.2 x 59.1)	1
58843	4 x 2 cabinet 4- CADJ-3 cup dispensers and 3 "T" holders with straw	31½ x 14¼ x 23¼ (80.3 x 36.2 x 59.1)	1

*NSF® certified



ITEM #	DESCRIPTION	DIMENSIONS (H X W X D): IN (CM)	CASE LOT
STAINLESS STEEL CUP DISPENSER CABINETS WITH INC-80 GASKET STYLE CUP DISPENSER AND LIDSAVER™ 2			
G58821-(lid code)	1 single-cabinet LidSaver 2	8¾ x 7½ x 23¼ (22.2 x 18.1 x 59.1)	1
G58822-(lid code)-(lid code)	2-high vertical 2-LidSaver 2	16¾ x 7½ x 23¼ (41.6 x 18.1 x 59.1)	1
G58822-(lid code)-A	2-high vertical 1-LidSaver 2, 1-INC-80 cup dispenser	16¾ x 7½ x 23¼ (41.6 x 18.1 x 59.1)	1
G58823-S-(lid code)-A	3-high vertical LidSaver 2, 1-INC-80 cup dispenser, 1-LS02 with straw pocket	24 x 7½ x 23¼ (61 x 18.1 x 59.1)	1
G58823-(lid code)-A-A	3-high vertical LidSaver 2, 2-INC-80 cup dispensers, 1-LS02	24 x 7½ x 23¼ (61 x 18.1 x 59.1)	1
G58823-(lid code)-(lid code)-(lid code)	3-high vertical LidSaver 2	24 x 7½ x 23¼ (61 x 18.1 x 59.1)	1
G58824-S-(lid code)-(lid code)-(lid code)	4-high 3-LidSaver 2 with straw pocket	31½ x 7½ x 23¼ (80.3 x 18.1 x 59.1)	1
G58824-S-(lid code)-A-A	4-high vertical 1-LidSaver 2, 2-INC-80 cup dispenser with straw pocket	31½ x 7½ x 23¼ (80.3 x 18.1 x 59.1)	1
G58824-(lid code)-(lid code)-A-A	4-high 2-LidSaver 2, 2-INC-80 cup dispenser	31½ x 7½ x 23¼ (80.3 x 18.1 x 59.1)	1
G58824-(lid code)-(lid code)-(lid code)-(lid code)	4-high vertical LidSaver 2	31½ x 7½ x 23¼ (80.3 x 18.1 x 59.1)	1
G58836-(lid code)	2 x 2 cabinet, 2-INC-80 cup dispenser, 1-LS02 with straw pocket	16¾ x 14¼ x 23¼ (41.6 x 36.2 x 59.1)	1
G58837-(lid code)-(lid code)	3 x 2 cabinet 2-LidSaver 2, 3-INC-80 cup dispenser with straw pocket	24 x 14¼ x 23¼ (61 x 36.2 x 59.1)	1
G58838-(lid code)-(lid code)-(lid code)	4 x 2 cabinet 3-LidSaver 2, 4-INC-80 cup dispenser, 1-LS02 with straw pocket	31½ x 14¼ x 23¼ (80.3 x 36.2 x 59.1)	1
STAINLESS STEEL CUP DISPENSER CABINETS WITH CADJ-3 STAINLESS STEEL CUP DISPENSERS AND LIDSAVER 2			
G58822-(lid code)-D	2-high vertical 1-LidSaver 2, 1-CADJ-3 cup dispenser	16¾ x 7½ x 23¼ (41.6 x 18.1 x 59.1)	1
G58823-S-(lid code)-D	3-high vertical LidSaver 2, 1-CADJ-3 cup dispenser, 1-LS02 with straw pocket	24 x 7½ x 23¼ (61 x 18.1 x 59.1)	1
G58823-(lid code)-D-D	3-high vertical LidSaver 2, 2-CADJ-3 cup dispenser, 1-LS02	24 x 7½ x 23¼ (61 x 18.1 x 59.1)	1
G58824-(lid code)-(lid code)-D-D	4-high vertical cabinet LidSaver 2, 2-CADJ-3 cup dispenser, 2-LS02	31½ x 7½ x 23¼ (80.3 x 18.1 x 59.1)	1
G58842-(lid code)-(lid code)	3 x 2 cabinet 2-LidSaver 2, 3-CADJ-3 cup dispenser with straw pocket	24 x 14¼ x 23¼ (61 x 36.2 x 59.1)	1
G58843-(lid code)-(lid code)-(lid code)	4 x 2 cabinet 3-LidSaver 2, 4-CADJ-3 cup dispensers, and 1-LS02 with straw pocket	31½ x 14¼ x 23¼ (80.3 x 36.2 x 59.1)	1

COUNTERTOP DISPENSERS & ORGANIZERS

NEW Stainless Steel Spring-Loaded Cup Dispensers

- Stainless steel
- Designed to be mounted to a wall or stand
- Spring-loaded units (SLC series) come with 2 springs: 1 standard spring for paper and plastic cups and 1 lighter spring for foam cups



ITEM #	DESCRIPTION	DIMENSIONS (L X D): IN (CM)	CASE LOT
SLC-1	Spring-loaded adjustable cup dispenser. Accommodates cup diameters 2¼"-2⅞".	25¾ x 3⅞ (65.4 x 7.9)	1
SLC-2	Spring-loaded adjustable cup dispenser. Accommodates cup diameters 2⅞"-3½"	25¾ x 3¾ (65.4 x 9.5)	1
SLC-3	Spring-loaded cup dispenser. Accommodates cup diameters 3½"-4⅞"	25⅞ x 4⅞ (65.7 x 11.1)	1
SLC-4	Spring-loaded adjustable cup dispenser. Accommodates cup diameters 4⅞"-4⅞"	26⅞ x 5⅞ (68.3 x 13.2)	1
PLC-1	Pull/gravity-feed adjustable cup dispenser. Accommodates cup diameters 2¼"-2⅞"	25¾ x 3⅞ (65.4 x 7.9)	1
PLC-2	Pull cup dispenser. Accommodates cup diameters 2⅞"-3½"	25¾ x 3¾ (65.4 x 9.5)	1
PLC-3	Pull cup dispenser. Accommodates cup diameters 3½"-4⅞"	25⅞ x 4⅞ (65.7 x 11.1)	1
PLC-4	Pull cup dispenser. Accommodates cup diameters 4⅞"-4⅞"	26⅞ x 5⅞ (68.3 x 13.2)	1



NEW Stainless Steel Lid Dispensers

- Stainless steel
- Designed to be mounted to a wall or stand



ITEM #	DESCRIPTION	DIMENSIONS (H X D): IN (CM)	CASE LOT
LD2-2	2 compartments to accommodate lids with a max 4⅞" diameter. Mounting brackets included.	25½ x 4⅞ (64.8 x 11)	1
LD3-2	2 compartments to accommodate lids with a max 4⅞" diameter. Mounting brackets included.	25½ x 5 (64.8 x 12.7)	1

NEW Stainless Steel Rotating Stand for Cup & Lid Dispensers

- Stainless steel
- Designed for rotating
- Heavy-duty metal construction



ITEM #	DESCRIPTION	DIMENSIONS (H X W X D): IN (CM)	CASE LOT
RSCL-4	Can accommodate 4 dispensers	40 x 1 x 15 (101.6 x 2.5 x 38.1)	1

NEW Stainless Steel Organizers

- Stainless steel
- Keyholes allow for wall mounting
- 3-, 4-, or 5-section adjustable lid organizer options



ITEM #	DESCRIPTION	DIMENSIONS (H X W X D): IN (CM)	CASE LOT
CTL3	Horizontal 3-section adjustable lid organizer with straw holder. Keyhole for wall mounting.	8 x 12½ x 5 (20.3 x 31.8 x 12.7)	1
CTL4	Horizontal 4-section adjustable lid organizer with straw holder. Keyhole for wall mounting.	8 x 16½ x 5 (20.3 x 41.9 x 12.7)	1
CTL5	Horizontal 5-section adjustable lid organizer with straw holder. Keyhole for wall mounting.	8 x 22½ x 5 (20.3 x 57.2 x 12.7)	1
SH-1	Straw holder, part of the CTL units – component here	5 x 4⅞ x 5 (12.7 x 10.5 x 12.7)	1

Lid and Cup Organizers

- A complete line that offers space-saving options for maximum organization
- Keeps operations clean and tidy
- Accommodates lids and cups up to 4¾" diameter
- Easy to use



CTCL-3B



ITEM #	DESCRIPTION	DIMENSIONS (W X D X H) IN (CM)	FOR CUPS/LIDS WITH RIM DIAMETER: IN (CM)	COLOR
CTCL-3B	3-high countertop organizer	6½ x 18¾ x 17½ (15.4 x 47.6 x 44.5) base only 12½ (30.6) D	2½" to 4¾"	Black ABS plastic and smoked acrylic
CTCL-4B	4-high countertop organizer	6½ x 22½ x 21¼ (15.4 x 57.2 x 53.3) base only 15½ (40.2) D	2½" to 4¾"	Black ABS plastic and smoked acrylic

Condiment, Cup, and Lid Organizer

- Accommodates lids and cups up to 4¾" diameter
- A complete line that offers space-saving options for maximum organization
- Keeps operations clean and tidy
- Easy to use



LDS-4CUP



ITEM #	DESCRIPTION	DIMENSIONS (W X D X H): IN (CM)	COLOR
LDS-4CUP	Countertop condiment and cup/lid organizer	11½ x 21 x 20¼ (29.2 x 53.3 x 51.4)	Black ABS plastic

Condiment Organizers

- A complete line that offers space-saving options for maximum organization
- Keeps operations clean and tidy
- Easy to use
- FIFO units help maintain first-in, first-out procedure
- CTCPAN units include pans



ITEM #	DESCRIPTION	DIMENSIONS (W X D X H): IN (CM)	COLOR
CFIFO-4	FIFO condiment holder for packs, 4 sections	16½ x 10½ x 16½ (42.2 x 25.7 x 41.9)	Black ABS plastic and smoked acrylic
CFIFO-2X	FIFO condiment holder for packs, 4 sections 2 high x 2 wide	8¼ x 12 x 16½ (21 x 30.5 x 43)	Black ABS plastic and smoked acrylic
CTCPAN9-9	Countertop condiment organizer, includes 9 - ½ black plastic pans	15½ x 22 x 14½ (39.4 x 55.9 x 37.1)	Black ABS plastic and smoked acrylic
CTCPAN3-6	Countertop condiment organizer, includes 3 - ½ black plastic pans	7½ x 21 x 14½ (19.5 x 53.3 x 37.1)	Black ABS plastic and smoked acrylic
CTC-3V	3-high vertical condiment stand	5½ x 10¼ x 16½ (15.1 x 27 x 41.6)	Black ABS plastic and smoked acrylic
CTC-3X2V*	3 x 2 wide vertical condiment stand with adjustable dividers	11¾ x 10¼ x 16½ (28.9 x 27 x 41.6)	Black ABS plastic and smoked acrylic
CTC-4V	4-high vertical condiment stand	5½ x 11½ x 20¼ (15.1 x 27 x 52.7)	Black ABS plastic and smoked acrylic

*Item CTC-3X2V features a moving vertical barrier to customize compartment sizes

Coffee Sleeve Dispensers

- Unit holds 100 sleeves
- CSLV-2H reduces waste by allowing one sleeve dispensed at a time



ITEM #	DESCRIPTION	DIMENSIONS (W X D X H): IN (CM)	COLOR
CSLV-2H	Coffee sleeve dispenser – horizontal	5 ¹ / ₁₆ x 11 ¹ / ₁₆ x 11 ¹ / ₁₆ (14.4 x 27.8 x 28.3)	Black ABS plastic and smoked acrylic
CSLV-1	Coffee sleeve dispenser – vertical	6 ¹ / ₂ x 4 ¹ / ₄ x 9 ⁷ / ₈ (16.5 x 12.2 x 25.1)	Black ABS plastic

Vertical Countertop Dispensers

- Keep operations clean and tidy
- Reclaim valuable counter space
- Durable ABS construction
- Easy loading
- CTL units accommodate lids up to 4⁷/₈"



ITEM #	DESCRIPTION	DIMENSIONS (W X H X D): IN (CM)	CASE LOT
LSC3-3P	Condiment holder, three-pocket, vertical cabinet	6 ⁷ / ₈ x 21 ³ / ₈ x 13 (17.5 x 54.3 x 33)	1
LSC4-4P	Condiment holder, four-pocket, vertical cabinet	6 ⁷ / ₈ x 28 ¹ / ₄ x 13 (17.5 x 72.1 x 33)	1
CTL-3VS	3-column lid and 1 straw holder, vertical cabinet	5 ¹ / ₂ x 24 ¹ / ₂ x 13 (13.9 x 62.2 x 33)	1
CTL-4VS	4-column lid and 1 straw holder, vertical cabinet	5 ¹ / ₂ x 28 ¹ / ₄ x 13 (13.9 x 71.8 x 33)	1
CTL-2VS	2-column lid and 1 straw holder, vertical cabinet	5 ¹ / ₂ x 18 ³ / ₄ x 13 (13.9 x 45.7 x 33)	1

LSC4-4P

CTL-4VS

Quik-Pik™ Toothpick Dispensers

- Convenient bottom loading makes refilling easy
- 500 bulk round toothpick capacity



ITEM #	DIMENSIONS (L X W X H): IN (CM)	COLOR	CASE LOT
3853-06	4 ³ / ₄ x 4 ¹ / ₄ x 4 ¹ / ₄ (11.1 x 10.8 x 10.5)	Black	1

Flatware Vertical Holders



CTFWH-6B



ITEM #	DESCRIPTION	DIMENSIONS (W X D X H): IN (CM)	COLOR
FVWH-3B	3high flatware vertical holder Includes 3 flatware cylinders #52633	5 ³ / ₄ x 10 ¹ / ₄ x 21 ¹ / ₄ (14.6 x 26 x 54)	Black ABS plastic and smoked acrylic
FVWH-3X2B	3 x 2 flatware vertical holder Includes 6 flatware cylinders #52633	11 ³ / ₁₆ x 10 ¹ / ₄ x 21 ¹ / ₄ (28.4 x 26 x 56.2)	Black ABS plastic and smoked acrylic
CTFWH-6B	3 x 2 countertop flatware holder Includes 6 flatware cylinders #52633	10 ¹ / ₈ x 14 ⁷ / ₈ x 14 ¹ / ₈ (25.7 x 37.8 x 36)	Black ABS plastic and smoked acrylic
CTFWH-8B	4 x 2 countertop flatware holder Includes 8 flatware cylinders #52633	10 ¹ / ₈ x 18 ¹ / ₈ x 17 ¹ / ₄ (25.7 x 46 x 43.8)	Black ABS plastic and smoked acrylic

FVWH-3B





Self-Serve Dispenser System

- Versatile self-serve bins can be used alone, stacked, or mounted
- Ideal for flatware, tea, condiment packets, salt & pepper, or products with high-volume usage
- Made of durable plastic
- Stands can be secured together with aluminum clips



Wall-mounting rail

ITEM #	DESCRIPTION	DIMENSIONS (L X W X H): IN (CM)	CASE LOT
SETS			
4840-xx	2-tier w/two 8" bins and clips	5% x 12½ x 9% (14.3 x 31.8 x 23.2)	1
4841-xx	2-tier w/two 11¼" bins and clips	5% x 19¾ x 9% (14.3 x 50.2 x 23.2)	1
4842-xx	3-tier w/three 8" bins and clips	5% x 16 x 13% (14.3 x 40.6 x 35.2)	1
4843-xx	3-tier w/three 11¼" bins and clips	5% x 19¾ x 13% (14.3 x 50.2 x 35.2)	1
COMPONENTS			
4804-xx	Single 8" bin	5 x 8 x 4½ (12.7 x 20.3 x 11.4)	1
4806-xx	Single 11¼" bin	5 x 11¼ x 4¼ (12.7 x 28.6 x 10.8)	1
4820-xx	2-tier stand w/3 clips	5% x 7¾ x 9 (14.3 x 19.7 x 22.9)	1
4830-xx	3-tier stand w/3 clips	5% x 11¾ x 13% (14.3 x 29.8 x 34.9)	1
91954	Aluminum wall-mounting rail 31" (holds 6 bins)	31" (79 cm) long	1

Add suffix number to indicate color (brown -01, black -06)

Countertop Condiment Straw & Lid Holders

- Keep operations clean and tidy
- Durable ABS construction
- Ideal for limited counter space to maximize storage
- LDS-3 is designed to stand alone or sit on top of the cup and LidSaver™ cabinets
- LDS-3 can accommodate straws up to 10¼" L
- Max. lid diameter for VL-3 and VL-4 is 4¾"



ITEM #	DESCRIPTION	STRAW DIAMETER IN (CM)	STRAW LENGTH IN (CM)	DIMENSIONS (W X H X D): IN (CM)	CASE LOT
CTS-2A	Stir stick/straw dispenser, countertop	½ (0.3)	6 (15.2)	7 X 5¾ X 5 (17.7 X 14.6 X 12.7)	1
LDS-3	Condiment/straw holder and organizer	—	10¼ (26)	7¾ X 9¾ X 24¾ (18.7 X 24.8 X 63.2)	1
DLH-1	Dome lid holder – single stack	—	—	4 X 11 1/16 X 4 (10.1 X 28 X 10.1)	1
VL-3*	3-column lid holder, countertop step design	—	—	6 X 16 X 15¼ (15.2 X 40.6 X 46.4)	1
VL-4*	4-column lid holder, countertop step design	—	—	6 X 20½ X 24½ (15.2 X 40.6 X 46.4)	1



FLUSH-MOUNT DISPENSERS & ORGANIZERS

Flush-Mount Dispensers

- Make the most of valuable retail space
- Mounts flush into food counter
- Constructed with virtually indestructible black thermoplastic
- Napkin dispensers – spring-loaded for continuous dispensing
- Accommodates lids up to 4 7/8"



FMDL-3H



FML-2V



FMN-1



FML-2



FMNL-1



FMS-4



FMS-2A



FMHVN-1



TT-2

ITEM #	DESCRIPTION	ACCOMMODATES	DIMENSIONS W X H X D: IN (CM)	CUTOUT DIMENSIONS W X H: IN (CM)	CASE LOT
FMN-1	Napkin dispenser, 5"h x 6½"w (12.7 x 16.5 cm), folded napkin	90	8½ x 6¼ x 5⅝ (21.6 x 15.9 x 13.7)	7⅞ x 5⅝ (19.2 x 13.5)	1
FMHVN-1	Napkin dispenser, high volume, 3½ x 6½ (8.9 x 15.2 cm), folded napkin	500	7⅞ x 8½ x 19½ (18.1 x 21.6 x 49.5)	6⅞ x 7⅞ (15.7 x 19.3)	1
FMNL-1	1 napkin dispenser and 1 lid holder, horizontal, 5"h x 6½"w (12.7 x 16.5 cm), folded napkin	100	11⅞ x 8 x 7½ (28 x 20.3 x 19.1)	9⅞ x 7⅞ (24.2 x 17.9)	1
FML-1	1-column lid holder, horizontal or vertical	—	6½ x 7¼ x 5⅝ (16.5 x 18.4 x 13.7)	5⅞ x 6⅞ (14.1 x 16)	1
FML-2V	2-column lid holder, vertical	—	6½ x 13⅞ x 5⅝ (16.5 x 34.1 x 13.7)	5⅞ x 12½ (14.1 x 31.7)	1
FML-3V	3-column lid holder, vertical	—	6½ x 19⅞ x 5⅝ (16.5 x 49.2 x 13.7)	5⅞ x 18⅞ (14.1 x 46.8)	1
FML-4V	4-column lid holder, vertical	—	6½ x 25½ x 5⅝ (16.5 x 64.8 x 13.7)	5⅞ x 24⅞ (14.1 x 62.3)	1
FML-2	2-column lid holder, horizontal	—	11 x 7¼ x 5⅝ (27.9 x 18.4 x 13.7)	10⅞ x 6⅞ (25.5 x 16)	1
FML-3	3-column lid holder, horizontal	—	16 x 7¼ x 5⅝ (40.6 x 18.4 x 13.7)	15 ⅞ x 6⅞ (38.2 x 16)	1
FML-4VS	4-column lid and 1 straw holder, vertical	—	6½ x 31½ x 13 (16.5 x 80 x 33)	5⅞ x 30⅞ (14.1 x 66.6)	1
FMDL-2V	2-stack dome lid holder, vertical	—	6¾ x 13⅞ x 12 (17.1 x 34 x 20.5)	5⅞ x 12½ (14.1 x 31.7)	1
FMDL-3H	3-stack dome lid holder, horizontal	—	18⅞ x 8⅞ x 10½ (48 x 20.4 x 26.6)	17⅞ x 7⅞ (45.4 x 16.1)	1
FMDL-3V	3-stack dome lid holder, vertical	—	6¾ x 18⅞ x 13 (17.1 x 47.9 x 33.7)	5⅞ x 18 (14.9 x 45.7)	1
FMS-2A	Stir stick dispenser, accommodates up to 6" L	—	8⅞ x 7⅞ x 5¼ (20.6 x 18.7 x 13.3)	7¼ x 6⅞ (18.4 x 16.1)	1
FMS-3	Wrapped straw holder, 8-10" straws	—	6½ x 7½ x 7½ (16.5 x 19.1 x 19.1)	5⅞ x 6⅞ (14.2 x 16.1)	1
FMS-4	Wrapped straw holder, 10-12" straws	—	6½ x 7½ x 13 (16.5 x 19.1 x 33)	5⅞ x 6⅞ (14.2 x 16.1)	1
FMS-5	Stir stick holder	—	6½ x 7½ x 5⅞ (16.5 x 19.1 x 14.9)	5⅞ x 6⅞ (14.2 x 16.1)	1
FMT-1	Waxed tissue dispenser, two-box design	—	8½ x 8½ x 3½ (21.6 x 21.6 x 8.9)	7⅞ x 7⅞ (18.5 x 17.9)	1
TT-2	Trash receptacle insert, 8" diameter	—	8 x 9¼ x 6½ (20.3 x 23.5 x 16.5)	8⅞ (21.2) dia	1

Trash Receptacle Doors

- Doors mount flush into counter
- Quality imprinted image
- Icon clearly indicates purpose
- MTS-1 units come with a spring for vertical or horizontal flush mount



ITEM #	DESCRIPTION	DIMENSIONS (W X H X D): IN (CM)	CUTOUT DIMS (W X H): IN (CM)	CASE LOT
MT-1	Trash receptacle door, small, vertical flush-mount	10 ⁹ / ₈ x 7 ¹ / ₂ x 2 (27 x 19.1 x 5.7)	9 ¹ / ₈ x 6 ³ / ₈ (24.6 x 16.6)	1
MT-1.5	Trash receptacle door, medium, flush-mount	13 x 7 ¹ / ₂ x 2 (33.7 x 19.1 x 5.7)	12 ³ / ₈ x 6 ³ / ₈ (31.2 x 16.6)	1
MTS-1	Trash receptacle door, small with spring for vertical or horizontal flush-mount	10 ⁹ / ₈ x 7 ¹ / ₂ x 2 (27 x 19.1 x 5.7)	9 ¹ / ₈ x 6 ³ / ₈ (24.6 x 16.6)	1
MT-2	Trash receptacle door, large, vertical flush-mount	17 ⁷ / ₈ x 7 ¹ / ₂ x 2 (44.8 x 19.1 x 5.7)	16 ¹ / ₈ x 6 ³ / ₈ (42.3 x 16.6)	1
MR-1.5	Trash receptacle door with "Recycled" logo, medium, vertical flush-mount	13 x 7 ¹ / ₂ x 2 (33.7 x 19.1 x 5.7)	12 ³ / ₈ x 6 ³ / ₈ (31.2 x 16.6)	1
MR-2	Trash receptacle door with "Recycled" logo, large, vertical flush-mount	17 ⁷ / ₈ x 7 ¹ / ₂ x 2 (44.8 x 19.1 x 5.7)	16 ¹ / ₈ x 6 ³ / ₈ (42.3 x 16.6)	1

ModuServ® Dispensers

- Mounts flush into counters
- Ultimate flexibility – easy to modify in endless configurations
- Clear faceplate secures components in place
- Components sold separately
- Tough, impact-resistant thermoplastic



Note: MLM-1 and MN-2 are sold separate

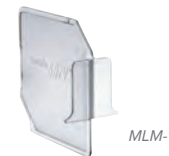

ITEM #	DESCRIPTION	DIMENSIONS (W X H X D): IN (CM)	CASE LOT
MRBM-1	ModuServ receptor box with faceplate, small	10 ³ / ₄ x 5 ¹ / ₈ x 7 ¹ / ₂ (27.3 x 13.8 x 19.1)	1
MRBM-2	ModuServ receptor box with faceplate, medium	17 ¹ / ₄ x 5 ¹ / ₈ x 7 ¹ / ₂ (45.1 x 13.8 x 19.1)	1
MRBM-3	ModuServ receptor box with faceplate, large	22 ¹ / ₄ x 5 ¹ / ₈ x 7 ¹ / ₂ (56.5 x 13.8 x 19.1)	1
MCM-1	ModuServ condiment divider	1 ¹ / ₈ x 6 x 6 ³ / ₈ (.3 x 15.3 x 16.2)	1
MLM-1	ModuServ lid divider	1 ¹ / ₈ x 6 x 6 ³ / ₈ (.3 x 15.3 x 16.2)	1
MN-2	ModuServ napkin dispenser, fits 6 ¹ / ₂ " W x 5" H (16.5 x 12.7 cm) folded napkin	8 ¹ / ₂ x 5 x 5 ¹ / ₈ (21.6 x 13.3 x 11.3)	1
MS-2A	ModuServ stir stick dispenser, bulk stir sticks, fits up to 1/8" diameter x 5 ¹ / ₂ " L (.32 x 14 cm) straw	7 ¹ / ₈ x 6 x 5 ¹ / ₈ (18.1 x 15.3 x 13)	1
MW-1	ModuServ waxed paper dispenser, midget size	7 ³ / ₈ x 6 x 5 ¹ / ₈ (18.3 x 15.9 x 13)	1

Flush-Mount Dispensers – Straw & Flatware/Condiment



ITEM #	DESCRIPTION	DIMENSIONS (W X D X H) IN (CM)	CUTOUT DIMENSIONS (W X H): IN (CM)	ACCOMMODATES STRAWS: IN (CM)	COLOR
FMS-6	Flush-mount – "T" shaped wrapped straw dispenser. Holds 200 straws.	10 ⁹ / ₈ x 4 ¹ / ₈ x 7 ³ / ₈ (26.8 x 12.2 x 18.6)	9 ¹ / ₈ x 5 ¹ / ₄ (23.2 x 14.6)	8 L (20.3)	Black ABS plastic
FMS-7	Flush-mount unwrapped straw dispenser. Dispenses one straw at a time. Holds 200 straws.	10 ⁹ / ₈ x 4 ¹ / ₂ x 7 ³ / ₈ (26.8 x 11.4 x 18.7)	9 ¹ / ₂ x 6 ¹ / ₈ (24.1 x 15.6)	.230 (.58) to .265 (.67) diameter and 7 ¹ / ₂ to 8 ³ / ₄ (19.1 to 22.2) L	Black ABS plastic
FMF-2	Flush-mount flatware or condiment holder – comes with 2 #52633	12 ¹ / ₈ x 6 ⁷ / ₈ x 7 ¹ / ₂ (30.8 x 17.5 x 19.1)	11 ³ / ₈ x 6 ³ / ₄ (28.9 x 17.1)	—	Black ABS plastic
FMF-3	Flush-mount flatware holder – comes with 3 #52633	17 ³ / ₈ x 6 ⁷ / ₈ x 7 ¹ / ₂ (44.8 x 17.5 x 19.1)	17 x 6 ³ / ₄ (43.18 x 17.1)	—	Black ABS plastic

Bag Dispensers

- Dispenser mounts flush into counter
- Durable ABS construction



ITEM #	DESCRIPTION	DIAMETER: IN (CM)	CUTOUT DIMENSIONS W X H: IN (CM)	CASE LOT
MB-1	Bag dispenser, 2 compartments, flush mount	10 ⁵ / ₈ x 7 ¹ / ₂ (27 x 19)	9 ⁵ / ₈ x 6 ⁵ / ₈ (24.7 x 16.7)	1

NAPKIN DISPENSERS

Napkin Dispensers



- Napkin dispenser is built into the cabinet
- Cabinet is made of durable ABS



CTNFO-06

CTNO-06

ITEM #	DESCRIPTION	DIMENSIONS (W X D X H): IN (CM)	COLOR
CTNO-06	Countertop napkin dispenser (folded and interfold napkins 5 x 6 ¹ / ₂ to 4 ¹ / ₂ - 5 x 6 ¹ / ₂ - holds 100 napkins) and condiment organizer. Adjustable compartments.	9 ⁵ / ₈ x 19 ¹ / ₄ x 15 ³ / ₈ (24.4 x 48.9 x 38.6)	Black ABS plastic and smoked acrylic
CTNCLS-06	Countertop napkin dispenser (folded and interfold napkins 5 x 6 ¹ / ₂ to 4 ¹ / ₂ - 5 x 6 ¹ / ₂ - holds 100 napkins) cup, lid, straw organizer	9 ⁵ / ₈ x 19 ¹ / ₄ x 15 ³ / ₈ (24.4 x 48.9 x 38.6)	Black ABS plastic and smoked acrylic
CTNFO-06	Countertop napkin dispenser (folded and interfold napkins 5 x 6 ¹ / ₂ to 4 ¹ / ₂ - 5 x 6 ¹ / ₂ - holds 100 napkins), condiment organizer and flatware holder. Comes with 4- #52633	9 ⁵ / ₈ x 19 ¹ / ₄ x 15 ³ / ₈ (24.4 x 48.9 x 38.6)	Black ABS plastic and smoked acrylic

Wall-Mounted Napkin Dispensers



- Save valuable counter space
- Dispensers feature a heavy-gauge metal housing with durable plastic faceplate
- Features unique locking system for reducing pilferage
- Offers an exclusive overload protection
- Dimensions: 8"L x 11¹/₈"W x 6"H (20.3 x 19.7 x 15.2)



ITEM #	FOLDED NAPKIN SIZE: IN (CM)	OVERALL DIMENSIONS	CAPACITY	COLOR	CASE LOT
6512-88	5 ¹ / ₄ x 6 ¹ / ₂ (13.3 x 16.5)	8 x 11 ¹ / ₈ x 6 (20.3 x 19.7 x 15.2)	175	Black	1

In-Counter Napkin Dispensers

- Mounts horizontally, vertically, or diagonally



6525-13



FMHVN-1



ITEM #	DESCRIPTION	FOLDED NAPKIN SIZE: IN (CM)	INTERFOLD NAPKIN SIZE: IN (CM)	OVERALL DIMENSIONS	CAPACITY	COLOR	CASE LOT
6535-13	Stainless steel limited in-counter saves 10% usage	5 x 6 ¹ / ₂ or 5 ¹ / ₄ x 6 ¹ / ₂ (12.7 x 16.5 or 13.3 x 16.5)	4 ¹ / ₄ - 5 ¹ / ₄ x 6 ¹ / ₂ (10.7 x 13.3 x 16.5)	19 ¹ / ₂ x 9 ¹ / ₂ x 7 ³ / ₄ (49.5 x 24.1 x 19.6)	500	Chrome	1
6520-28	Stainless steel in-counter dispenser	3 ³ / ₄ x 6 ¹ / ₂ (9.5 x 16.5)		19 ¹ / ₂ x 9 ¹ / ₂ x 6 ³ / ₄ (49.5 x 24.1 x 17.1)	500	Chrome	1
6525-13	Stainless steel in-counter dispenser	5 x 6 ¹ / ₂ or 5 ¹ / ₄ x 6 ¹ / ₂ (12.7 x 16.5 or 13.3 x 16.5)		5 x 6 ¹ / ₂ or 5 ¹ / ₄ x 6 ¹ / ₂ (12.7 x 16.5 or 13.3 x 16.5)	500	Clear	1
6525-28	Stainless steel in-counter dispenser	5 x 6 ¹ / ₂ or 5 ¹ / ₄ x 6 ¹ / ₂ (12.7 x 16.5 or 13.3 x 16.5)		5 x 6 ¹ / ₂ or 5 ¹ / ₄ x 6 ¹ / ₂ (12.7 x 16.5 or 13.3 x 16.5)	500	Chrome	1
FMHVN-1*	Black ABS in-counter high-volume dispenser	5 x 6 ¹ / ₂ (12.7 x 16.5)		8 ¹ / ₂ x 7 ¹ / ₈ x 19 ¹ / ₂ (21.6 x 18.1 x 49.5)	500	Black	1

*Only mounts vertically or horizontally



5500-06



8545-06



5509-12



7545-12



46798



7540-06



6512-06



6513-06



7512-06



6509-06



8540-06



6516-06



7516-06



6515-06

Table & Countertop Napkin Dispensers

- Limited napkin dispensers reduce waste – save 10% on total usage
- Dispensers feature a heavy-gauge metal housing with durable plastic faceplates
- Choose from in-counter, countertop, or tabletop models in the color and style that fits your needs
- Countertop dispensers offer exclusive overload protection feature, helps prevent napkins from tearing



HOUSING COLORS & FINISHES

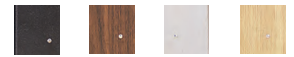

06 black
12 dark walnut
28* stainless steel
29 light oak woodgrain

FACEPLATE COLORS



clear chrome transparent brown

ITEM #	DESCRIPTION	DIMENSIONS (L X W X H): IN (CM)	FOLDED NAPKIN SIZE IN (CM)	INTERFOLD NAPKIN SIZE IN (CM)	CAPACITY	FACEPLATE COLOR	STOCK COLORS	CASE LOT
7545-xx	Limited tabletop dispenser	8 x 6 ³ / ₈ x 6 (20.3 x 15.7 x 15.2)	5 x 6 ¹ / ₂ to 4 ¹ / ₂ -5 x 6 ¹ / ₂ (12.7 x 16.5 or 11.4 x 16.5)	4 ¹ / ₄ x 5 ¹ / ₄ x 6 ¹ / ₂ (11.4 x 13.3 x 16.5)	90	Clear	06, 12	1
8545-xx	Limited tabletop dispenser	8 x 6 ³ / ₈ x 6 (20.3 x 15.7 x 15.2)	5 x 6 ¹ / ₂ to 4 ¹ / ₂ -5 x 6 ¹ / ₂ (12.7 x 16.5 or 11.4 x 16.5)	4 ¹ / ₄ x 5 ¹ / ₄ x 6 ¹ / ₂ (11.4 x 13.3 x 16.5)	90	Black	06 only	1
5515-xx	Two-sided tabletop dispenser	8 x 6 x 5 (20.3 x 15.2 x 12.7)	3 ³ / ₄ x 6 ¹ / ₂ (9.5 x 16.5)	–	90	Transparent brown	12 only	1
6515-xx	Two-sided tabletop dispenser	8 x 6 x 5 (20.3 x 15.2 x 12.7)	3 ³ / ₄ x 6 ¹ / ₂ (9.5 x 16.5)	–	90	Chrome plate	06 only	1
6516-xx	Two-sided tabletop dispenser	8 x 6 ³ / ₈ x 6 (20.3 x 15.7 x 15.2)	5 x 6 ¹ / ₂ or 5 ¹ / ₄ x 6 ¹ / ₂ (12.7 x 16.5 or 13.3 x 16.5)	–	90	Chrome plate	06 only	1
7516-xx	Two-sided tabletop dispenser	8 x 6 ³ / ₈ x 6 (20.3 x 15.7 x 15.2)	5 x 6 ¹ / ₂ or 5 ¹ / ₄ x 6 ¹ / ₂ (12.7 x 16.5 or 13.3 x 16.5)	–	90	Clear	06, 12	1
5500-xx	Two-sided vertical dispenser	4 x 4 ³ / ₈ x 7 ³ / ₈ (10.2 x 11.1 x 18.7)	3 ¹ / ₂ x 6 ³ / ₈ (8.9 x 17.1)	–	150	None	06 only	1
6509-xx	Two-sided vertical dispenser	4 x 6 ³ / ₈ x 5 ⁷ / ₈ (10.2 x 15.7 x 14.9)	3 ¹ / ₂ x 5 (8.9 x 12.7)	–	100	Chrome plate	06, 12	1
5509-xx	Two-sided vertical dispenser	4 x 6 ³ / ₈ x 5 ⁷ / ₈ (10.2 x 15.7 x 14.9)	3 ¹ / ₂ x 5 (8.9 x 12.7)	–	100	Transparent brown	12 only	1
46798	One-sided spring-loaded tabletop napkin holder	3 ¹ / ₂ x 7 (8.9 x 17.8)	3 ¹ / ₂ x 6 ³ / ₈ (8.9 x 17.1)	–	135	None	28* only	1
8540-xx	One-sided limited dispenser	11 ³ / ₄ x 7 ⁷ / ₈ x 6 ¹ / ₂ (29.8 x 20 x 16.5)	5 x 7 (9.5 x 17.8)	4 ¹ / ₄ x 5 ¹ / ₄ x 6 ¹ / ₂ (11.4 x 13.3 x 16.5)	175	Black	06 only	1
7540-xx	One-sided limited dispenser	11 ³ / ₄ x 7 ⁷ / ₈ x 6 ³ / ₄ (29.8 x 20 x 17.1)	5 x 6 ¹ / ₂ to 4 ¹ / ₂ -5 x 6 ¹ / ₂ (12.7 x 16.5 or 11.4 x 16.5)	4 ¹ / ₄ x 5 ¹ / ₄ x 6 ¹ / ₂ (11.4 x 13.3 x 16.5)	175	Clear	06 only	1
5512-xx	One-sided countertop dispenser	11 ¹ / ₈ x 8 x 6 (29.7 x 20.3 x 15.2)	5 x 6 ¹ / ₂ or 5 ¹ / ₄ x 6 ¹ / ₂ (12.7 x 16.5 or 13.3 x 16.5)	–	175	Transparent brown	12 only	1
6512-xx	One-sided countertop dispenser	11 ¹ / ₈ x 8 x 6 (29.7 x 20.3 x 15.2)	5 x 6 ¹ / ₂ or 5 ¹ / ₄ x 6 ¹ / ₂ (12.7 x 16.5 or 13.3 x 16.5)	–	175	Chrome plate	06, 12, 28*	1
6513-xx	One-sided countertop dispenser	11 ¹ / ₈ x 8 x 5 (29.5 x 20.3 x 9.5)	3 ³ / ₄ x 6 ¹ / ₂ (9.5 x 16.5)	–	185	Chrome plate	06 only	1
7512-xx	One-sided countertop dispenser	11 ¹ / ₈ x 8 x 6 (29.7 x 20.3 x 15.2)	5 x 6 ¹ / ₂ or 5 ¹ / ₄ x 6 ¹ / ₂ (12.7 x 16.5 or 13.3 x 16.5)	–	175	Clear	06 only	1

Add two-digit suffix (xx) after hyphen (-) to indicate color. See color options above.

* Stainless steel has 30% surcharge

STRAW DISPENSERS



3845-12



3821-06



3835-12



3810-12



3815-28



3820-28



3802-02



3825-06



3805-06



3855-06

Straw Boss® Straw Dispensers

- Reduce waste and save money
- Dispensing mechanism for bulk straws allows one-at-a-time dispensing
- Dispensers feature a heavy-gauge metal housing with plastic lids and dispensing bars



For easy access to Vollrath's complete line of countertop and in-counter dispensers, visit VOLLRATH.com/dispensers.

ITEM #	DESCRIPTION	STRAW DIAMETER IN (CM)	STRAW LENGTH IN (CM)	DIMENSIONS (L X W X H): IN (CM)	CAPACITY	COLORS AVAILABLE	CASE LOT
3810-xx	Double-sided wrapped straw dispenser	.275 to .310 (.7 to .8)	7½ - 8¾ (19.1 - 22.2)	9 x 7½ x 7 (22.9 x 19.1 x 17.8)	400	06, 12, 28	1
3815-xx	Single-sided wrapped straw dispenser	.275 to .310 (.7 to .8)	7½ - 8¾ (19.1 - 22.2)	9 x 4 x 7 (22.9 x 10.2 x 17.8)	200	06, 12, 28 29	1
3805-xx	Single-sided wrapped straw dispenser	.230 to .310 (.6 to .8)	9 - 12 (22.9 - 30.5)	12¼ x 4¾ x 7 (31.1 x 11.3 x 17.8)	200	06, 12, 28	1
3802-xx	Double-sided bulk straw dispenser	.230 to .265 (.6 to .7)	7½ - 8¾ (19.1 - 22.2)	9 x 7½ x 7 (22.9 x 19.1 x 17.8)	500	02, 06, 12, 28	1
3855-xx	Single-sided bulk straw dispenser	.230 to .265 (.6 to .7)	7½ - 8¾ (19.1 - 22.2)	9 x 7½ x 7 (22.9 x 19.1 x 17.8)	500	06	1
3825-xx	Single-sided bulk straw dispenser	.230 to .265 (.6 to .7)	7½ - 8¾ (19.1 - 22.2)	9 x 4 x 7 (22.9 x 10.2 x 17.8)	250	02, 06, 12, 28, 29	1
3821-xx	Single-sided bulk straw dispenser	.275 to .310 (.7 to .8)	9 - 12 (22.9 - 30.5)	12½ x 5½ x 7 (31.8 x 14 x 17.8)	250	06	1
3820-xx	Single-sided bulk straw dispenser	.230 to .265 (.6 to .7)	9 - 12 (22.9 - 30.5)	12½ x 5½ x 7 (31.8 x 14 x 17.8)	250	06, 12, 28	1
3835-xx	Single-sided bulk straw dispenser	.275 to .310 (.7 to .8)	7½ - 8¾ (19.1 - 22.2)	9 x 4 x 7 (22.9 x 10.2 x 17.8)	250	06, 12	1
3845-xx	Double-sided bulk straw dispenser	.275 to .310 (.7 to .8)	7½ - 8¾ (19.1 - 22.2)	9 x 7½ x 7 (22.9 x 19.1 x 17.8)	500	12	1

Add suffix to signify color: red -02, black -06, dark walnut woodgrain -12, stainless steel -28, light oak woodgrain -29



FOOD DELIVERY & TRANSPORT

Food delivery has never been more in demand. So we upped our game by creating the highest-quality bags, using the latest technology. So you give customers what they want, how they want it.

How to Shop

FOOD DELIVERY & TRANSPORT

Pizza Bags



We construct these bags with high-performance insulation and a condensation-reducing liner that keeps food at the right temperature and ensures quality again and again.

Pages 314

Catering Bags



Two types of catering bags. Zero left to chance. We use only the highest quality insulation to maintain both temperature and quality, coupled with waterproof materials that are easy to clean and ready to go.

Pages 314-315

Tower Bags



Large orders need big solutions. So we use high-performance insulation to make sure your food gets there warm and gets big smiles from customers.

Pages 316

DESCRIPTION	3-SERIES ITEM #	5-SERIES ITEM # WITH DIVIDERS	5-SERIES ITEM # WITH HEAT PAD	5-SERIES ITEM # WITH HEAT PAD & POWER PACK	DIMENSIONS (L X W X H): IN (CM)
CONTAINER CAPACITY CHART					
PIZZA BAGS					
16" Pizza bag	VPB316	–	VPB516	–	17½ x 17½ x 9 (44.5 x 44.5 x 22.9)
18" Pizza bag	VPB318	–	VPB518	VPB5P18	19 x 19 x 9 (48.3 x 48.3 x 22.9)
CATERING BAGS					
Medium catering bag with vinyl liner	VDBM300	VDBM500	–	–	17 x 13 x 9 (43.2 x 33.0 x 22.9)
Medium catering bag with removable liner and 2 pan separators	VCBM300	–	VCBM500	–	17 x 13 x 9 (58.4 x 38.1 x 35.6)
Large catering bag with removable liner and 3 pan separators	VCBL300	–	VCBL500	VCBL5P00	23 x 15 x 14 (58.4 x 38.1 x 35.6)
TOWER BAGS					
Tower bag with backpack straps and headrest strap	VTB300	–	VTB500	VTB5P00	18 x 22 x 17 (45.7 x 55.9 x 43.2)
Tower bags with wire inserts , backpack straps, and headrest strap	VTBW300	–	VTBW500	VTBW5P00	18 x 22 x 17 (45.7 x 55.9 x 43.2)
FOOD DELIVERY BACKPACKS					
Food delivery backpack bag with integrated frame	VDBBM300	–	VDBBM500	VDBBM5P00	16 x 16 x 13 (40.6 x 40.6 x 33)

Food Delivery Backpack Bags



A long day of delivery needs long-term thinking. We construct these backpack bags with high-performance insulation to maintain temperature, quality, and comfort. So everyone walks away happy.

Pages 317

Delivery Bag Accessories

Amazing technology needs great add-ons. From leveling wedges to cold packs, we have what you need to get it there and get it right.

Page 316

EPP Food Carrier



Even the environment needs delivery to be at its best. So we designed a food carrier with best-in-class insulation that's as ergonomic and recyclable as it is lightweight and durable.

Page 317

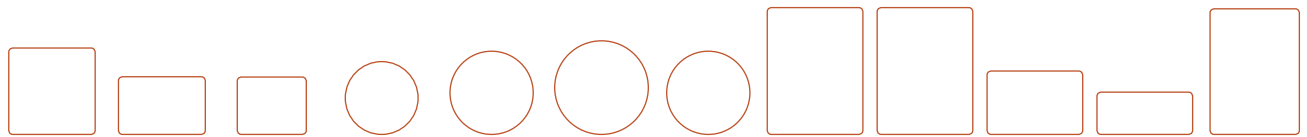

9x9	6x9	5x6	14" PIZZA	16" PIZZA	18" PIZZA	16" ROUND TRAYS	19" X 14 1/2" TRAYS	12" X 20" FULL-SIZE PAN	12" X 10" HALF-SIZE PAN	12" X 6" 1/3 SIZE PAN	13" X 18" HALF-SIZE SHEET PAN WITH COVER
-----	-----	-----	-----------	-----------	-----------	-----------------	---------------------	-------------------------	-------------------------	-----------------------	--

6	12	12	4	3	–	2	1	2	2	4	3
8	12	12	4	4	3	2	1	2	2	4	3
6	9	18	–	–	–	–	–	–	2	4	–
6	9	18	–	–	–	–	–	–	2	4	–
8	16	24	6	6	–	3	3	3	6	9	4
20	30	30	10	10	–	5	–	–	5	8	7
8	16	24	10	10	–	5	–	–	5	10	5
4	8	18	4	–	–	–	–	–	3	6	–

EXTEND YOUR DELIVERY RANGE AND PROVIDE A RESTAURANT-QUALITY EXPERIENCE FOR YOUR CUSTOMERS AT HOME.

- 1 Internal walls lined with 8 mm foil to help maintain proper temperature by directing heat/cold to the inside of the bag
- 2 Large zipped PVC window for branding, or housing order slips, menus, or brochures
- 3 Reflective piping for safer nighttime delivery
- 4 Super-durable high-quality moisture-resistant outer shell material shelters food from the elements
- 5 High-performance insulation and condensation-reducing liner holds food at a consistent temperature and ensures food quality
- 6 Extra reinforced stitching for superior strength and durability
- 7 Handles are made from heavy-duty webbing, making delivery comfortable and easy
- 8 Catering bags include solid floor panels to ensure stability while loading and transporting food and beverages
- 9 Customization is available
- 10 Collapsible for compact storage
- 11 Commercial-grade zippers and Velcro
- 12 Integrated power pack pocket (select models only)



3-Series



The baseline of warmth ingenuity. The hot food generates heat in the bag while the high-performance insulation helps retain the heat, keeping food as warm as it is delicious.

5-Series WITH HEAT PAD



The next step in our heating bag line features a heat pad that pre-heats the bag. Place your hot food into the pre-heated bag, unplug the heat pad and go. Or use the optional 12V in-car power cord to continually heat the bag during transport.

5-Series WITH HEAT PAD & POWER PACK



Optimize bag temperature, food quality, and delivery range. Select the temperature, pre-heat the bag, and continually heat the bag during transport. Use the included 12V in-car charge to recharge the lithium ion battery power pack in between deliveries.

NEW Pizza Bags



- Designed to hold pizza boxes but adaptable enough to transport other menu items
- Heavy-duty locking clips that keep load secure
- Closing flap with high-quality wide Velcro tabs
- Hanging loop for proper drying
- Extra helper handle on back of bag for stabilization when unloading
- Anchor strap to secure bag to bike tray or for hanging
- Customization available



Large window for branding, menus



Heavy-duty locking clip

3-SERIES

- Optional heat pad with power cord to pre-heat bag to better maintain food quality and extend delivery range

5-SERIES WITH HEAT PAD

- Includes heat pad with power cord to pre-heat bag to better maintain food quality and extend delivery range
- Optional 12V power cord plugs into a vehicle's DC receptacle to continually power the heat pad during delivery (Item VDBPCC sold separately)

5-SERIES WITH HEAT PAD & POWER PACK

- Includes portable power pack with heat pad, a 120VAC and a 12V car charger to better maintain food quality and extend delivery range
- Power pack provides five heat settings for added flexibility and food quality control

ITEM #	DESCRIPTION	DIMENSIONS (L X W X H): IN (CM)	CASE LOT
3-SERIES PIZZA BAGS			
VPB316	16" Pizza bag, 3-Series	17½ x 17½ x 9 (44.5 x 44.5 x 22.9)	6
VPB318	18" Pizza bag, 3-Series	19 x 19 x 9 (48.3 x 48.3 x 22.9)	6
5-SERIES WITH HEAT PAD			
VPB516	16" Pizza bag and heat pad with 120VAC power cord, 5-Series	17½ x 17½ x 9 (44.5 x 44.5 x 22.9)	1
VPB518	18" Pizza bag and heat pad with 120VAC power cord, 5-Series	19 x 19 x 9 (48.3 x 48.3 x 22.9)	1
5-SERIES WITH HEAT PAD & POWER PACK			
VPB5P18	18" Pizza bag with power pack and heat pad with 120VAC and 12V car chargers, 5-Series	19 x 19 x 9 (48.3 x 48.3 x 22.9)	1

NEW Catering Bags with Vinyl Liner

- Vinyl waterproof liner is easy to clean
- 5-Series includes 12-compartment divider to keep beverages, soup and sides upright and organized during transportation
- Handles are made of heavy-duty webbing, making delivery comfortable and easy
- Solid floor panels ensure stability during transport
- Easy-opening, zipped lid flap for superior insulation
- Adjustable heavy-duty carry straps
- Customization available



Shown with 12 compartment divider

ITEM #	DESCRIPTION	DIMENSIONS (L X W X H): IN (CM)	CASE LOT
3-SERIES			
VDBM300	Medium catering bag with vinyl liner, 3-Series	17 x 13 x 9 (43.2 x 33 x 22.9)	4
5-SERIES			
VDBM500	Medium catering bag with vinyl liner and 12-compartment divider insert, 5-Series	17 x 13 x 9 (43.2 x 33 x 22.9)	1

NEW Catering Bags with Removable Liner



- Large bags feature strong reinforced plastic side handles for easy lifting
- Handles are made of heavy-duty webbing, making delivery comfortable and easy
- Solid floor panels ensure stability during loading and transport
- Removable spill liner for easy cleaning
- Removable pan separators provide additional support when stacking pans or other transport containers
- Easy-opening, zipped lid flap for superior insulation
- Adjustable heavy-duty carry straps
- Bulk pockets on sides are great for holding condiments, flatware, 2-liter bottles, and more

3-SERIES

- Optional heat pad with power cord to pre-heat bag to better maintain food quality and extend delivery range

5-SERIES WITH HEAT PAD

- Includes heat pad with power cord to pre-heat bag to better maintain food quality and extend delivery range
- Optional 12V power cord for in-car use

5-SERIES WITH HEAT PAD & POWER PACK

- Includes portable power pack with heat pad, a 120VAC and a 12V car charger to better maintain food quality and extend delivery range
- Power pack provides five heat settings for added flexibility and food quality control

ITEM #	DESCRIPTION	DIMENSIONS (L X W X H): IN (CM)	CASE LOT
3-SERIES CATERING BAGS			
VCBM300	Medium catering bag with removable liner and 2 pan separators, 3-Series	17 x 13 x 9 (43.2 x 33 x 22.9)	6
VCBL300	Large catering bag with removable liner and 3 pan separators, 3-Series	23 x 15 x 14 (58.4 x 38.1 x 35.6)	4
5-SERIES WITH HEAT PAD			
VCBM500	Medium catering bag with removable liner, 2 pan separators, and heat pad with 120VAC power cord, 5-Series	17 x 13 x 9 (43.2 x 33 x 22.9)	1
VCBL500	Large catering bag with removable liner, 3 pan separators, and heat pad with 120VAC power cord, 5-Series	23 x 15 x 14 (58.4 x 38.1 x 35.6)	1
5-SERIES WITH HEAT PAD & POWER PACK			
VCBL5P00	Large catering bag with removable liner, 3 pan separators, power pack and heat pad with 120VAC and 12V car chargers, 5-Series	23 x 15 x 14 (58.4 x 38.1 x 35.6)	1

NEW Tower Bags

- Strong reinforced plastic handles for easy lifting
- Adjustable backpack straps ideal for bikes and scooters
- Headrest strap and leveling wedge keep bag secure during transportation
- Unique optional removable wire frame insert for organization and stability – offers adjustable shelves and collapses for storage
- Metal steam exhaust port releases moisture without releasing heat



3-SERIES

- Optional heat pad with power cord to pre-heat bag to better maintain food quality and extend delivery range

5-SERIES WITH HEAT PAD

- Includes heat pad with power cord to pre-heat bag to better maintain food quality and extend delivery range
- Optional 12V power cord for in-car use



Collapses for storage

5-SERIES WITH HEAT PAD & POWER PACK

- Includes portable power pack with heat pad, a 120VAC and a 12V car charger to better maintain food quality and extend delivery range
- Power pack provides five heat settings for added flexibility and food quality control

ITEM #	DESCRIPTION	DIMENSIONS (W X H X D): IN (CM)	CASE LOT
3-SERIES TOWER BAGS			
VTB300	Tower bag with backpack straps, headrest strap, 3-Series	18 x 22 x 17 (45.7 x 55.9 x 43.2)	4
VTBW300	Tower bag with backpack straps, headrest strap, and wire frame insert, 3-Series	18 x 22 x 17 (45.7 x 55.9 x 43.2)	1
5-SERIES WITH HEAT PAD			
VTB500	Tower bag with backpack straps, headrest strap, and heat pad with 120VAC power cord, 5-Series	18 x 22 x 17 (45.7 x 55.9 x 43.2)	1
VTBW500	Tower bag with backpack straps, headrest strap, and wire frame insert, and heat pad with 120VAC power cord, 5-Series	18 x 22 x 17 (45.7 x 55.9 x 43.2)	1
5-SERIES WITH HEAT PAD & POWER PACK			
VTB5P00	Tower bag with backpack straps, headrest strap, power pack, and heat pad with 120VAC and 12V car chargers, 5-Series	18 x 22 x 17 (45.7 x 55.9 x 43.2)	1
VTBW5P00	Tower bag with backpack straps, headrest strap, wire frame insert, power pack, and heat pad with 120VAC and 12V car chargers, 5-Series	18 x 22 x 17 (45.7 x 55.9 x 43.2)	1

NEW Food Delivery Bag Accessories

ITEM #	DESCRIPTION	ITEM #	DESCRIPTION
VDBW	Delivery bag leveling wedge	VDBPCC	12V car charger for power pack
V904500	Cold pack	VDBPACC	120VAC power cord for power pack
1697	Rack dolly, beige	VCBLSS	Liner for large catering bag
1698	Rack dolly handle	VCBMSS	Liner for medium catering bag
VAC1212	Heat pad	VMCOMP12	12-compartment divider for medium catering bag with vinyl liner
VP1212	Heat pad for use with power pack	VDBPSS	Back straps
VDBACC	12V power cord	VDBPB	Power pack (lithium ion battery)
VDBCC	AC power cord	CBLD3	Large catering bag pan separators – pack of 3
		CBMD2	Medium catering bag pan separators – pack of 2

NEW Food Delivery Backpack Bags



- Metal steam exhaust vent to releases moisture without releasing heat
- Adjustable backpack straps to make delivery comfortable and easy
- Integrated frame for added stability
- Strong, heavy-duty double carry straps

3-SERIES

- Optional heat pad with power cord to pre-heat bag to better maintain food quality and extend delivery range

5-SERIES WITH HEAT PAD

- Includes heat pad with power cord to pre-heat bag to better maintain food quality and extend delivery range
- Optional 12V power cord for in-car use

5-SERIES WITH HEAT PAD & POWER PACK

- Includes portable power pack with heat pad, a 120VAC and a 12V car charger to better maintain food quality and extend delivery range
- Power pack provides five heat settings for added flexibility and food quality control
- Removable wire frame insert for organization and stability

ITEM #	DESCRIPTION	DIMENSIONS (W X H X D): IN (CM)	CASE LOT
3-SERIES			
VDBBM300	Food delivery backpack bag with integrated frame, 3-Series	16 x 16 x 13 (40.6 x 40.6 x 33)	4
5-SERIES WITH HEAT PAD			
VDBBM500	Food delivery backpack bag with integrated frame and heat pad with 120VAC power cord, 5-Series	16 x 16 x 13 (40.6 x 40.6 x 33)	1
5-SERIES WITH HEAT PAD & POWER PACK			
VDBBM5P00	Food delivery backpack bag with integrated frame, power pack and heat pad with 120VAC and 12V car chargers, 5-Series	16 x 16 x 13 (40.6 x 40.6 x 33)	1

EPP FOOD CARRIER

NEW EPP Food Carrier

- Lightweight yet durable material that helps maintain food and beverage temperatures for hours
- Ideal for carrying full-size food pans – up to 6" deep
- 100 percent recyclable
- Optional set of HACCP color tags for quick identification – order separately



Shown with optional color tag



ITEM #	DESCRIPTION	DIMENSIONS (W X H X D): IN (CM)	CASE LOT
VEPP106	Full-size EPP insulated carrier with lid for 6" deep food pans, black, 1-Series	23¾ x 15¾ x 10 (60.2 x 39.9 x 25.4)	1
IDEPP-5	Set of HACCP color tags - includes white, red, green, yellow and blue		1

How to Use

APPENDIX

Alphabetical Index

Products are listed in alphabetical order. When searching, look for broad product categories followed by details. For example, if you're searching for a utility cart, look under "Carts, Utility."

Pages 318–323

A	
Acrylic Bowls	186
Adaptor Bars	100
Adaptor Plates	100-101
Adjustable Dish Caddy	284-285
Aluminum Cookware	119, 120-1125, 126-130
Antimicrobial Utensils	141-144, 146, 149, 151-153, 155
Au Gratins/Dishes	189, 238
Avenger™ Chafer	210
B	
Backpack Bags	311-312, 317
Bags, Backpack	311-312, 317
Bags, Catering	311-312, 314-315
Bags, Delivery	311-312, 317
Bags, Pizza	311-312, 314-315
Bags, Tower	311-312, 316
Bain Marie Drop-In	99
Bain Marie Hot Display Case	70
Bains Marie	70, 82, 85, 99
Bake and Roast Pans	136
Bakeware	135-137
Bakery Display Cases	71-73
Baking Sheets	133-135
Bar Keep™ II Storage	228
Bar Mat	229
Bar Service	227-229
Bar Trays	248-249

Baskets	48, 108, 112, 241, 276, 281
Batter Boss® Portion Control Dispenser	170
Batter Can	170
Bench Mixer	21-22
Bent Square Buffet Risers	224
Beverage Bins	231
Beverage Bin Stands	231
Beverage Service	23-236
Boilers and Fryers (Cookware)	124
Bowls, Acrylic	186
Bowls, Colored	220
Bowls, Double-Wall	220-223
Bowls, Fluted	186, 188, 221
Bowls, Ice	227
Bowls, Melamine	186
Bowls, Mixer	21
Bowls, Mixing	21, 22, 163
Bowls, Salad	237, 247
Bowls, Soup	180, 249
Bowl Stands	163
Brass Trim Chafers	209
Braziers	109, 112, 115, 121
Breath Guards	216
Breath Guards, Hot Dog Roller	44
Breath Guards, Mobile	216
Brushes	172
Buffet Risers	224

Numerical Index

Item numbers starting with "0" shown first. Then numeric index is sorted by the number of digits (or numbers before dash (-) or a letter if applicable). Asterisk denotes incomplete item number. See page number for details.

Pages 324–333

Item numbers that begin with a letter start on page 331

Buffet Risers, Bent	224
Buffet Stations, Contoured	198
Buffetware	213-215
Bun Pans	133-135
Bus Boxes	283
Bussing Carts	292
Butter Melter	246
C	
Cake Pans	137
Cake Server	245
Cake Stand	245
Can Openers	20
Card/Napkin Holders	305-308
Carriers, EPP Insulated	316
Carts	75, 289-293
Carts, Bussing	292
Carts, Heavy-Duty	289
Carts, Knock-Down	290
Carts, Utility	291
Carving Station, Contoured	198
Catering Bags	311-312, 314-315
Cayenne® Colonial Kettles Food Warmer	60
Cayenne® Display Cases and Merchandisers	74-75
Cayenne® Heated Shelves	64
Cayenne® Heat Lamp	64
Cayenne® Heat & Light Strips	65
Cayenne® Heavy-Duty Charbroilers	45

Cayenne® Heavy-Duty Griddles	45	Contoured Platters and Stands	198	Cup Dispensers	298
Cayenne® Heavy-Duty Induction Ranges	31	Convection Ovens	42	Cup Racks	259, 261
Cayenne® Heavy-Duty Thermostatic Griddles	46	Convertible Toasters	38	Cup, Soup	249
Cayenne® Warmers & Rethermalizers	59-63	Conveyor Pizza Ovens	39	Custom Products	139, 226
Cereal Dispenser	206	Conveyor Sandwich Ovens	40	Cutlery Boxes	276, 282
Chafers	199-210	Conveyor Toasters	35-37	Cutters	16-17
Chafer Accessories	211-215	Cookers, Strainers	125	Cutting Boards	159, 183, 185, 188
Chafer Boxes	212	Cookie Sheets	135	Cutting Board Rack	159
Chafer Heater	211	Cookware, 3-Ply	107-109	Cutting Board Table	183
Chafer Rack	212	Cookware, Aluminum	119, 120-1125, 126-130	<i>D</i>	
Charbroilers	45	Cookware, Carbon Steel	117-118, 131	Dakota™ Chafer	210
Check Holders	172, 248	Cookware, Centurion®	106, 110-112	Decorative Induction Warmers, Mirage®	54
Check Spindle	247	Cookware, Induction-Ready	56-57	Decorative Pans, Miramar®	194-195
Cheese Blocker™	16	Cookware, Intrigue®	107-109, 200	Delivery Bags	311-312, 317
Cheese Cutter	173	Cookware, Optio™	116	Dessert Service	245
Cheese Melter	41	Cookware, Stainless Steel	106-118	Dicers	11-13
Cheese Shakers	243	Cookware, Tribute®	107-109	Dish Boxes and Covers	278, 283
Chicken Rotisserie Ovens	42	Cookware, Tri-Ply	107-109, 189-197	Dish Caddy	284-285
China Cap Strainers	165	Cookware, Wear-Ever®	109-117	Dishers	136-138
Choppers	11-19	Cooling Plates	186	Dishers, Extended Length	137
Classic Brass Trim Accessories	200, 209	Corkscrews	232	Dish Racks	239-260
Classic Brass Trim Chafers	200, 209	Countertop Mixers	21-22	Dish Racks, Compartment	244-245, 248, 253-254, 259
Cocktail Shaker Sets	227	Cover Hinge, Flip-Top	75	Dish Racks, Dollies	264
Coffee and Tea Service	201-210	Covers, Aluminum	98	Dish Racks, Full-Size	245-247, 252-257
Coffee Sleeve Dispensers	303	Covers, Dish Box	278, 283	Dish Racks, Half-Size	248-249, 252, 259
Coffee Urn	201-203, 207-209, 211	Covers, Electric Fryers	48	Dish Racks, Hold-Down Grids	252
Colonial Kettles™ Food Warmer	60	Covers, Hinged Inset	56, 60, 75	Dish Racks, Imprinting	242, 251
Color-Mate™ Food Storage Boxes	166	Covers, Insets	75	Dish Racks, Plate Crate®	258
Colored Double-Wall Bowls	220	Covers, Intrigue® Cookware	115	Dispenser Holder, Sauce	159
Compartment Racks	256-258, 261, 266-268, 270, 274	Covers, Miramar® Soup Inset Cover	194	Dispensers, Beverage	171, 187-190
Compartment Trays	250	Covers, Sheet Pan	133	Dispensers, Cup	280-282
Condiment Caddies and Jars	242	Covers, Steam Table Pan	193	Dispenser, Frozen Beverage Granita	286-288
Condiment Dispensers	229	Covers, Tribute® Cookware	108	Dispensers, In-Counter	286-288
Condiment Organizers	297, 302	Creamers	236	Dispensers, Lid	280-282
Condiment Servers	237	Cruets	242	Dispensers, LidSaver™ 2	280-282
Contemporary Hinged Inset Lids	56	CubeKing™	16	Dispensers, Plastic	287
Contemporary Pans, Miramar®	193	Cubic Display Cases	71	Dispensers, Modular	287
Contemporary Serving Utensils, Miramar®	213	Cubic Display Sets	183-188	Dispensers, Napkin	286-289
Contoured Buffet Stations	198	Cubic Modular Display System	183-188	Dispensers, Stainless	287
Contoured Carving Stations	198	Cucumber Slicer	12	Dispensers, Squeeze	156-159

Dispensers, Straw	281, 284–286	ErgoGrip™ Basting Spoons	149	Gauge Reference Table	334
Dispensers, Toothpick	284	ErgoGrip™ Ladles	144	Glass Racks	274
Display Bowls	172–174, 206–209	Esquire™ Trays	217	Granita Machine	77
Display Cabinets	59–61	Extended Handle Dishers	147	Grater	173
Display Cases, Acrylic	62–63	E-Z Juice Extractors	17	Gravy Boats	246
Display Cookware	175–178	<i>F</i>		Griddles (Cookware)	45-46
Divided Food Pans	186, 196, 198	Fajita Skillet Heaters	33	Griddles, Electric	46
D-Lux™ Chafers	192	False Bottoms	87, 92-93, 223	Griddles, Gas	46
Dome Covers	91, 171, 176, 179	Finishing Ovens	41	Griddle Stones	171
Double Boilers	107-108, 114	Fiberglass Trays	249	Grills, Gas	45
Double-Wall Beverage Bins	217	Flared Sauce Cups	238	Grills, Hot Dog Roller	44
Double-Wall Pitcher	220	Flatware	239-240	Grill Tender®	19
Double-Wall Platters	205	Flatware Baskets	276, 281	Grinder Attachments, Mixer	21-22
Double-Wall Serving Bowls	206	Flatware Boxes	282	Grinders and Accessories	19
Double-Wall Serving Bowls, Colored	206	Flatware Cylinders	282, 303	Grip 'N Serv® Utensils	142, 155
Double-Wall Serving Bowls, Fluted	207, 223	Flatware Handling Accessories	275-277, 281-282	<i>H</i>	
Double-Wide Steam Table Pans	88	Flatware Holders, Countertop	303	Half-Size Racks	261-262
Drain Box	165	Flexible Pan Lids	88, 91	Hamburger Patty Mold	173
Dredges	159	Flip-Top Cover Hinge	75	Hammered Creamers & Servers	236
Dripcut® Cruets	228	Floor Mixers	21-22	Heated Display Cabinets	68-70
Dripcut® Dredges	169	Fluted Double-Wall Bowls	207, 223	Heated Shelves	64
Dripcut® Servers	170, 244	Food Container Pans	173	Heaters, Skillet	33
Dripcut® Shakers and Holders	243	Food Delivery Bags	311-312, 317	Heat Lamp	64
Drop-Ins, Bain Marie	99	Food Pans	83, 84-88, 89-91, 95-96, 193, 195, 211	Heat 'N Serve™ Food Rethernalizers	58-59
Drop-Ins, Display Cabinets	69	Food Preparation Brushes	172	Heat Strips	65
Drop-Ins, Induction	27, 31	Food Processors	11-19	Heavy-Duty Cayenne® Charbroilers	45
Drop-Ins, Soup	55	Food Storage Boxes	175	Heavy-Duty Cayenne® Griddles	46
Drop-Ins, Warmers	53-54	Food Transport	96	Heavy-Duty Cayenne® Induction Ranges	29, 31
Dual Warmer	62	Fork, Long Handle	150	Heavy-Duty Cayenne® Thermostatic Griddles	46
<i>E</i>		French Fry Scoops	171	Heavy-Duty Equipment Stands	43
EaziClean® Can Openers	20	French Whips	158	High-Temperature Utensils	56, 141-144
Egg Poachers	97	Frozen Treat Equipment	76-79	Hold-Down Grids	277, 282
Egg Slicer	173	Fruit Slicer	15	Hollow-Handle Buffetware	214
Electric Chafers	205	Fryers (Cookware)	48	Hooked-Handle Dipper	145
Electric Chafer Heaters	211	Fryers, Electric	48	Hooked-Handle Utensils	150
Elegant Reflections™ Trays	218	Fry Pans	125-128, 131	Hot Display Case, Bain Marie	61
Elevation Stands	224	Fuel Holders	212	Hot Dog Roller Grills	44
EPP Insulated Carriers	316	Full-Size Racks	244-247	Hot Food Merchandisers	70
Equipment	8–79	Funnels	162, 172	Hot Plates, Electric	44
Equipment Stands	43	<i>G</i>		Hot Plates, Gas	44

I		Ladles, Bicolite	145	Model SS-4 Food Warmer	62
Ice Bucket	227	Ladles, Dressing	145	Model TD-43R Rethermalizer	61
Ice Caddy	228	Ladles, ErgoGrip™	144	Model TW-27R Twin-Well Rethermalizer	59
Ice Cream Chiller	78, 245	Ladles, Short Handle	143	Moduserv® In-Counter Dispenser System	306
Ice Cream Scoops	78, 154	Lamp, Heat	64	N	
Ice Cream Spade	78, 154	Lettuce King® I	15	Napkin Dispensers	288–289
Ice Porters and Dolly	174	Lettuce King® IV	15	New York, New York® Accessories	189–190
Ice Scoop	228	Loaf Pan	135, 136	New York, New York® Chafer	189–190
Immersion Circulator	49	Lobster King™	19	New York, New York® Replacement Parts	189–190
Induction Buffet Station	198	M		Nitro™ Power Rethermalizer	50
Induction Buffet Warmers	53-54	Malt Cup	227	Nonstick Presentation Pan	77
Induction Cayenne® Heavy-Duty	29, 31	Manual Food Processors & Choppers	11-19	NSF-Approved Steak Weight	161
Induction Ranges & Cooktops	29–33	Maximillian Steel™ Chafers	207	O	
Induction Ranges, Worldwide	32-33	Measuring Cups/Ladles/Spoons	160–162	Odyssey™ Trays	204
Induction-Ready Chafers	199-200	Meat-Carving Station	198	Onion King®	16
Induction-Ready Cookware	106, 107-117, 118	Meat Slicers	23-24	Orion® Accessories	205, 233
Induction Rethermalizer	55–56	Meat Tenderizer	171	Orion® Beverage Service	233
Induction Wok Range	31	Melamine Bowls	186	Orion® Chafers	205
Inset Covers, Hinged	75	Menu Holder	247	Ovens (Convertible Toasters)	38
Insets, Vegetable	212	Microwave Ovens	43	Ovens, Convection	42
InstaBloom® II	14	Milk Dispenser	201-202	Ovens, Conveyor, Pizza	42
Insta Chill® Food Coolers	174	Milk Stirrer/Masher	172	Ovens, Conveyor, Sandwich	42
InstaCut™ 3.5	13	Mirage® Induction Buffet Warmers	53-54	Ovens, Microwave	43
InstaCut™ 5.1	12	Mirage® Induction Ranges	29-33	Ovens, Pizza/Bake	39-41
InstaSlice™	17	Mirage® Induction Soup Warmers	55	Ovens, Rotisserie	42
Intrigue® Induction Chafers	199-200	Mini Serving Vessels	179	Oyster King™	19
Intrigue® Induction Cookware	106, 113-115	Miramar® Contemporary Pans	193	P	
J		Miramar® Contemporary Utensils	213	Pails	174
Jacob's Pride® Collection	81, 84-85, 113, 119, 139, 149, 155, 158	Miramar® Decorative Pans	194-195	Panacea™ Chafers	208
Juice Extractors	17	Miramar® Display Cookware	175–178	Panini Presses	47
K		Miramar® Templates	196-197	Pan Bands	97
King Kutter™	16	Mixers	21-22	Pans, Aluminum Bakeware	135-157
Knives	239	Mixer Accessories	21-22	Pans, Cookware	106-135
Kondi-Keeper™ Condiment Dispenser	229	Mobile Breath Guards	216	Pan Scraper	157
Kool-Touch® Buffetware	215	Model 1001 Food Warmer	63	Pans, Decorative	194-195
Kool-Touch® Handles	144-145, 151-153	Model 1220 Rethermalizer	61	Pans, Nonstick	133-134
Kool-Touch® Ladles	144-145	Model 2000 Food Warmer	63	Pans, Perforated	87
Kool-Touch® Tongs	151-153	Model CM-24 Twin-Well Rethermalizer	59	Pans, Plastic	92–93
L		Model HS-7 and HS-11 Rethermalizer	58, 61	Pans, Prep and Holding	83-96
Ladles	133-135, 143, 215	Model PC-21 Rethermalizer	62		

Pans, Prep and Holding Accessories	95-98	Roast Pans	136	Skillet Heaters	33
Pans, Stainless Steel	89-91, 193	Roller Grills, Hot Dog	44	Skimmers	156
Party Pan	133	Rotisserie Ovens	42	Slicer Attachments, Mixer	22
Pasta Cooker	124-125	S		Slicers, Electric	23-24
Perforated Pans	87	Safety Mate™ Coolers	174	Slicers, Manual	23-24
Petrol Gel	19	Safety Mate™ Ice Porters	174	SoftSpoon™	157
Piano Whips	158	Salad/Buffer Spoons	213-215	Somerville® Chafers	201-202
Pie Markers	172	Salt & Pepper Sets	243	Soup Drop-Ins	55
Pie Plates	137	Sandwich Conveyor Oven	40	Soup Merchandisers	74
Pie Server	214	Sandwich Presses	47	Soup Rethermalizers	55-56
Pitchers	233-136	Sauce Boss® Portion-Control Dispenser	170	Soup Tureens	237
Pizza Bags	311-312, 314-315	Sauce Cups/Bowls	238	Sous Vide Immersion Circulator	49
Pizza/Bake Oven	39-41	Sauce Dispenser	169	Spade, Ice Cream/Utility	78, 154
Pizza Conveyor Ovens	42	Sauce Dispenser Holder	169	Spatulas	157-158
Plastic Pitcher	234-235	Sauce Pans	179-182	Spoodle® Utensils	141-142
Plastic Plate Covers	226	Sauce Pots	111, 113, 116, 120, 122-123	Spoon, Bar	227
Plastic Super Pan®	92-93	Sauciers	108, 114	Spoons, Nylon	150
Plate Covers	225-226	Saute Pans	108, 110, 115, 121, 123	Spoons, Nylon Handles	150
Plate Racks	260	Scoops, Dish	146-148	Spoons, Preparation	149-150
Platters	33, 185, 198, 218-219	Scoops, Ice	228	Spoons, Salad/Buffer	213-215
Platters, Double-Wall	219	Scoops, Ice Cream	78, 154	Spoons, Serving	213-215, 239-240
Portion Control	131-138	Scrapers	157	Square Bent Buffet Risers	224
Portion Control Dispenser	170	Seafood Service	245	Square Chafers	199-200
Potato Cutters	17	Self-Serve Dispenser System	301-304	Squeeze Bottles	167-168
Power Rethermalizer, Nitro™	62	Self-Serve Display Cabinets and Cases	69, 71-73, 185	Squeeze Bottle Holder	169
Presses, Sandwich	47	Servers, Condiment	237	Squeeze Dishers	147-148
Punch Bowl	203	Servers, Portion	141-148	Squeeze Dispensers	166-168
R		Servers, Revolving	246	Squeeze Dispenser Caps	168
Rack Component Parts	262	Servers, Three-Way	246	Stainless Steel Cookware	106-118
Rack Dollies	279	Service Plates	182, 217-219	Stainless Steel Steam Table Pans	193
Ramekins	161, 237-238	Serving Cups	179-182, 245	Stainless Steel Trays	217-219
Ranges, Cayenne® Heavy Duty Induction	29, 31	Shakers, Bar	227	Stands, Beverage Bin	231
Ranges, Induction	29-33	Sheet Pans	133-134	Stands, Elevation	224
Redco® Processors	11-19	Sheet Pan Cover	133	Stands, Equipment	43
Reducer Kits, Mixer	21-22	Shelves, Heated	64	Stands, Wine	230
Refrigerated Display Cabinets	68-69	Sieve	165	Steak Knives	239
Refuse Bins	293	Signs	251	Steak Weights	171
Rethermalizers	55-63	Silicone Baking Mat	135	Steamers	115
Retro Stock Pot Rethermalizers	58	Silv-A-Tainer	277	Steam Table Pans	80-81
Risers	224	Skewers	171	Stir Fry Pans	131

Stock Pots	108	Traex® Dish Caddy	284	W	
Stoppers, Wine/Champagne	232	Traex® Dish Racks	263-274, 281-282	Wall Hanger Bracket	17
Storage Containers	117	Traex® Dripcut® Shakers and Holders	243	Warewashing	252–288
Strainers and Colanders	164–165	Traex® Kondi-Keeper® Condiment Dispenser	229	Warmer Accessories	56, 61, 99, 134-144
Straw Boss® Straw Dispensers	209	Traex® Sauce Boss® Dispenser	170	Warmers, Cayenne®	59-63
Sugar Pourers and Holders	243	Traex® Squeeze Dispensers	166-168	Warranty Statement	335
Super Pan®	84-93	Traex® Trays	272	Waste Can Receptacle Insert	305
Super Pan® Super Shapes	83	Transfer Vessels	161	Waste Receptacle Doors	305-306
Super Pan V® Steam Table Pans	85-86	Trash Can Receptacle	305-306	Water Pans	211
SwirlServe® Beverage Servers	235	Trash Receptacle Doors	305-306	Wedgemaster™	14
Symbol Signs	251	Trays, Beer	248	Wedgemaster™ II	15
T		Trays, Double-Wall	219	Whips, French and Piano	158
Table Joiner	248	Trays, Fast Food	250	Windway® Buffetware	214
Tabletop Napkin Dispensers	308	Trays, Plastic	247	Wine Service	230-232
Talker™ Trays	249	Trays, Serving	217-219	Wine Stoppers	232
Tater King™ Scooper	18	Trays, Tip	247	Wire Cones	241
Templates, Miramar®	196-197	Tribute® Cookware	107-109	Wire Flight Caddies	231
Tenderizer	171	Triennium™ Beverage Service	233	Wire Grates	87, 135
Thermostatic Griddles	46	Trimline II Chafer	210	Wire Serving Pieces	241
Three-Way Servers	246	Tri-Ply Stock Pots	108	Worldwide Induction Ranges	32-33
Tilt 'N Pour® Servers	235	Tuffex™ Pitchers	234		
Toasters, Contact	38	Tuf Glas™ Fiberglass Trays	249		
Toasters, Convertible	38	Tumbler	249		
Toasters, Conveyor	37	Turners	155		
Tomato King® Scooper	18	Twin 7-Quart Rethermalizer	59		
Tomato Pro™	18	Twister® Wire Cones	241		
Tongs, Buffet	215	U			
Tongs, Ice	227	Universal Electric Heater	205		
Tongs, Kool-Touch®	151–153	Urn, Coffee	201-203, 207-211, 271		
Tongs, Pastry	153, 215	Utensils	141-162, 213, 215, 259		
Tongs, Scissors	153	Utility Carts	290-293		
Tongs, Serving	215				
Tongs, Spaghetti	153	V			
Tongs, Utility	153	Vacuum Pack Bags	25		
Toothpick Dispenser	303	Vacuum Pack Machines	25		
Tote 'N Store™ Boxes	212	Value Series Roll-Top Chafers	210		
Tower Bags	311-312, 316	Vegetable Cooker	124		
Traex® Bar Keep™ II Storage	228	Vegetable Insets	212		
Traex® Batter Boss® Dispenser	170	Vollrath University	7		
Traex® Color•Mate™ Food Storage Boxes	175				

ITEM	PAGE	ITEM	PAGE	ITEM	PAGE	ITEM	PAGE	ITEM	PAGE	ITEM	PAGE
4842-XX*	304	5635	251	7516-XX*	308	15115	17	30102	85	40701	42
4843-XX*	304	5638	251	7540-XX*	308	15125	13	30112	85	40702	42
4864-TT*	170	5643	251	7545-XX*	308	15126	14	30113	87	40703	42
4901-13	168	5644	251			15128	14	30122	85, 199	40704	42
4902-TT*	169					15149	19	30123	87	40705	48
4903-13	162					15150	14	30142	85	40706	48
4904-13	162					15202	17	30143	87	40707	48
4905-191	169					15203	17	30162	85	40708	48
4906-32	169					15204	17	30163	87	40709	48
4907-08	169					15205	17	30202	85	40710	48
4908-01	169					15206	17	30212	85	40711	48
4913-TT*	168					15207	17	30213	87	40712	48
4914-13	168					15208	17	30220	95, 96	40713	48
4916-02	167					15209	17	30222	85, 207, 208,	40714	48
4916-08	167					15604	11, 14		209, 210	40715	46
4916-13	167					19184	100	30223	87	40716	46
4916-13TT*	166					19186	100	30225	96	40717	46
4924-02	167					19188	61, 101	30240	96	40718	46
4924-08	167					19189	101	30242	85	40719	46
4924-13	167					19190	101	30243	87	40720	46
4924-13TT*	166					19192	101	30245	96	40721	46
4924C-BBTT*	166					19193	101	30260	96	40722	46
4932-02	167					19194	101	30262	85	40723	46
4932-08	167					19195	101	30263	87	40728	45
4932-13	167					19196	100	30265	96	40732	70
4932-13TT*	166					19198	61, 101	30288	96	40733	70
4961-1301	169					19199	100	30302	85	40734	70
4961-1308	169							30312	85	40735	70
4961-1332	169							30322	85	40736	44
4961-13191	169							30342	85	40737	44
								30362	85	40738	44
								30402	85	40739	44
								30412	85	40740	43
								30422	85	40741	43
								30442	85	40742	43
								30462	85	40743	19
								30512	85	40744	19
								30522	85	40755	21
								30542	85	40756	21
								30562	85	40757	21
								30622	86	40758	21
								30642	86	40759	21
								30662	86	40760	21
								30822	86	40761	21
								30842	86	40762	21
								30862	86	40763	21
								30922	86	40764	21
								30942	86	40765	21
								31100	93	40766	21
								31200	93	40767	21
								31300	93	40768	21
								31400	93	40769	21
								31500	93	40770	21
								31600	93	40771	21
								31900	93	40772	21
								32100	93	40773	21
								32200	93	40774	21
								32300	93	40775	21
								32400	93	40776	21
								32600	93	40777	21
								33100	92	40778	21
								33200	92	40779	21
								33300	92	40780	21
								33400	92	40781	21
								33500	92	40785	21
								33600	92	40786	21
								33900	92	40787	21
								34100	92	40790	47
								34200	92	40791	47
								34300	92	40792	47
								34400	92	40793	47
								34600	92	40794	47
										40794-C	47
										40795	47
										40795-C	47
										40812	25
										40813	25
										40814	25
										40815	25
										40816	25
										40817	25
										40818	25
										40819	43

*Not a complete item number – refer to page noted

ITEM	PAGE	ITEM	PAGE	ITEM	PAGE	ITEM	PAGE	ITEM	PAGE	ITEM	PAGE
47192	164	47402	147	47714	17	48101	240	48765	203	52127	235
47193	164	47403	147	47715	17	48102	240	48768	203	52130	235
47194	164	47404	147	47717	156	48103	240	48770	203	52131	235
47195	164	47406	238	47718	156	48104	240	48772	203	52132	235
47196	164	47408	238	47719	156	48110	240	48780	203	52133	235
47197	164	47422	238	47720	114	48112	240	48790	203	52134	235
47198	164	47425	238	47721	114	48113	240	48793	203, 212	52135	235
47199	164	47428	238	47722	114	48114	240	48794	203, 212	52140	235
47200	148	47429	238	47723	114	48115	240	48795	203, 212	52141	235
47204	241	47486	59, 62, 74,	47724	114	48116	240	49130	200	52142	235
47205	241		75, 99	47725	114	48122	240	49136	200	52143	235
47206	241	47488	56, 58, 75, 99	47726	114	48125	240	49241-1305	168	52144	235
47208	241	47490	56, 58, 59,	47730	113	48130	239, 240	49333	207, 208	52145	235
47212	218		61, 74, 75, 99, 212	47731	113	48131	240	49334	208, 211	52160	235
47214	218	47493	56, 99	47732	113	48133	240	49339	98, 212	52161	235
47216	218	47494	56, 99	47733	113	48140	239	49410	189	52162	235
47225	231	47522	246	47734	113	48141	239	49411	189	52163	235
47226	231	47536	249	47735	113	48142	239	49412	189	52164	235
47232	218	47555	249	47740	114	48143	239	49413	189	52165	279
47234	218	47556	249	47741	114	48144	239	49414	190, 191	52170	279
47236	218	47573	246	47742	114	48145	214	49415	190	52171	279
47238	218	47575	246	47743	114	48146	214	49416	189	52172	279
47242	218	47578	246	47745	115	48147	239	49417	189	52173	279
47251	219	47601	246	47746	115	48148	239	49418	190, 192	52174	279
47252	249	47602	232	47747	115	48150	240	49419	190	52175	279
47255	158	47603	232	47750	113	48151	240	49420	189, 192	52290	279
47256	158	47605	230	47751	113	48152	240	49423	190	52291	279
47257	158	47609	232	47752	113	48153	240	49424	189, 190,	52292	279
47258	158	47610	227	47753	113	48154	240		191, 192	52293	279
47259	158	47611	230	47755	113	48160	240	49425	190, 191	52355	262
47260	218	47612	227	47756	113	48161	240	49426	190	52356	262
47261	218	47615	230	47757	113	48162	240	49427	190	52357	262
47262	218	47616	230	47758	113	48171	240	49428	190	52358	262
47263	218	47617	230	47760	115	48200	239	49429	190	52359	262
47265	218	47619	222, 224	47761	115	48201	239	49430	190, 191	52360	262
47266	218	47619XX*	220	47762	115	48202	239	49431	190, 192	52362	262
47267	218	47620	230	47770	114, 115	48203	239	49432	190, 192	52363	262
47270	78, 154	47621	230	47771	113, 114, 115	48204	239	49433	190, 192	52366	24
47274	78, 154	47622	227	47772	114, 115	48205	239	49434	190, 192	52367	262
47275	78, 154	47625	230	47773	113, 114, 115	48206	239	49435	190, 192	52368	262
47276	78, 154	47630	230	47774	113, 114, 115	48207	239	49441	189, 191	52369	262
47277	78, 154	47631	236	47775	113, 115	48208	239	49442	189, 191	52370	262
47278	78, 154	47632	222, 224	47776	113, 114, 115	48209	239	49445	189, 191	52371	262
47279	78, 154	47632XX*	220	47777	110, 111, 112,	48220	239	49452	189, 191	52372	262
47280	158	47633	246		113, 115	48221	239	49520	207, 212	52385	277
47281	158	47634	222, 224	47778	113, 114, 115	48222	239	49521	207, 212	52420	278
47282	158	47634XX*	220	47779	114, 115	48223	239	49522	207, 212	52422	175, 278
47283	158	47635	222	47780	114, 115	48224	239	49523	207, 212	52424	275, 278
47284	158	47635XX*	220	47790	114	48225	239	49524	207, 212	52430	83, 88, 91
47285	158	47637	222	47791	114	48226	239	49525	207, 212	52430-02	88
47286	158	47637XX*	220	47792	114	48227	239	49529	207, 212	52431	88
47287	158	47648	242	47845	237	48228	239			52432	88
47309	153	47650	221	47892	215	48301	78, 245	<i>50661</i>	161	52432-02	88
47312	153	47651	221	47914	227	48303	78, 245	50662	161	52433	88
47316	153	47652	221	47930	163	48311	230	50663	161	52434-02	88
47322	152	47656	219	47932	163	48312	236	50664	161	52434	88
47325	153	47658	221	47933	163	48313	78, 245	50665	161	52435	88
47326	152	47659	222, 224	47934	163	48315	78, 245	50666	161	52611	278
47329	152	47664	223	47935	163	48317	236	50667	161	52612	278
47370	147	47672	222, 224	47938	163	48320	230	51003	126	52614	278
47371	147	47674	222	47943	163	48321	230	51008	126	52615	278
47372	147	47675	222	47946	163	48322	208, 212	51016	126	52616	175
47373	147	47677	222	47949	163	48323	208, 211, 212	51045	126	52617	275
47374	147	47680	221	47960	125	48324	208, 212	52009	147	52618	175
47375	147	47681	221	47963	164	48325	230	52010	147	52619	275
47376	147	47682	221	47965	164	48326	208, 212	52013	147	52621	278
47377	147	47683	221	47969	164	48327	208, 212	52016	147	52622	278
47378	147	47684	221	47974	164	48328	208, 212	52023	147	52629	278
47379	147	47685	221			48329	208, 212	52026	147	52632	278
47388	147	47686	221	<i>48003</i>		48330	230	52063	158	52633	303
47389	147	47687	221	48003	78, 245	48360	236	52064	158	52634	278
47390	147	47688	221	48013	78, 245	48365	235	52065	158	52640	276
47391	147	47689	221	48015	78, 245	48372	78	52100	149	52641	276
47392	147	47700	173	48023	245	48373	246	52109	147	52642	277
47393	147	47703	17	48060	78, 245	48375	246	52113	147	52643	277
47394	147	47704	17	48070	227	48378	246	52116	147	52644	277
47395	147	47705	173	48080	155	48425	215	52120	235	52645	200, 202, 203,
47396	147	47708	171	48081	155	48426	215	52121	235	205, 207, 208, 209,	
47397	147	47709	171	48082	155	48427	215	52122	235	210, 212	
47398	147	47710	171	48083	155	48428	215	52123	235	52646	205, 206, 212
47399	147	47711	171	48085	155	48429	215	52124	235	52647	199, 201, 203,
47400	147	47712	171	48100	240	48755	203	52125	235	204, 205, 206, 207, 208,	
47401	147	47713	17			48758	203	52126	235	209, 210, 212	

*Not a complete item number – refer to page noted

ITEM.....	PAGE	ITEM.....	PAGE	ITEM.....	PAGE	ITEM.....	PAGE	ITEM.....	PAGE	ITEM.....	PAGE
52648...	203, 204, 209, 210, 212	52767*	258, 262, 280	55468.....	12	58920.....	118	59788.....	181	64132.....	149
52649.....	213	52768* ...	258, 262, 280	55469.....	12	58930.....	118	59789.....	181	64134.....	149
52651.....	276	52769* ...	258, 262, 280	55470.....	12	59120.....	174	59790.....	182	64136.....	149
52652.....	276	52770* ...	258, 262, 280	55471.....	12	59145.....	30	59791.....	182	64138.....	149
52653.....	276	52771* ...	258, 262, 280	55472.....	12	59150.....	174	59792.....	182	64400.....	149
52654.....	276	52772* ...	258, 262, 280	55473.....	12	59200.....	174	59793.....	182	64401.....	149
52657.....	175, 278	52773* ...	258, 262, 280	55474.....	12	59202.....	174	59794.....	182	64402.....	149
52660.....	278	52774* ...	258, 262, 280	55475.....	12	59300.....	30	59795.....	182	64403.....	149
52661.....	278	52775* ...	258, 262, 280	55476.....	12	59310.....	30	59796.....	182	64404.....	149
52662.....	278	52776* ...	258, 262, 280	55477.....	12	59500F.....	33	59797.....	182	64405.....	149
52664*.....	260	52777* ...	258, 262, 280	55478.....	12	59500P.....	30	59798.....	182	64406.....	149
52665*.....	260	52778* ...	258, 262, 280	55479.....	12	59503LN75.....	54	59900.....	118	64407.....	149
52669*.....	260	52779* ...	258, 262, 280	55480.....	12	59503LN7502.....	54	59910.....	118	64408.....	149
52670*.....	259	52780* ...	258, 262, 280	55481.....	12	59503LN85.....	54	59920.....	118	67007.....	127
52671*.....	259	52781* ...	258, 262, 280	55482.....	12	59503LN8502.....	54	59949.....	132	67008.....	127
52672*.....	260	52782* ...	258, 262, 280	55483.....	12	59503SB75.....	54	59950.....	132	67010.....	127
52674*.....	259	52783* ...	258, 262, 280	55484.....	12	59503SB7502.....	54			67012.....	127
52675*.....	259	52784* ...	258, 262, 280	55485.....	12	59503SB85.....	54	60170.....	150	67014.....	127
52676*.....	259	52785* ...	258, 262, 280	55486.....	12	59503SB8502.....	54	60175.....	150	67133.....	123
52677*.....	259	52786* ...	258, 262, 280	55487.....	12	59508DW.....	53	60180.....	150	67135.....	123
52678*.....	260	52787* ...	258, 262, 280	55488.....	12	59510F.....	33	60190.....	150	67137.....	123
52680*.....	259	52788* ...	258, 262, 280	55489.....	12	59510P.....	30	61145.....	142	67228.....	121
52681*.....	259	52789* ...	258, 262, 280	55490.....	12	59735.....	179	61147.....	142	67301.....	129
52682*.....	259	52790* ...	258, 262, 280	55491.....	12	59736.....	179	61155.....	142	67302.....	129
52683*.....	259	52800*.....	262	55492.....	12	59737.....	179	61157.....	142	67303.....	129
52684* ...	258, 262, 280	52801*.....	262	55493.....	12	59738.....	179	61165.....	142	67304.....	129
52689* ...	258, 262, 280	52802*.....	262	55494.....	12	59739.....	179	61167.....	142	67305.....	129
52691* ...	258, 262, 280	52803*.....	262	55495.....	12	59740.....	179	61170.....	142	67307.....	129
52692* ...	258, 262, 280	52804*.....	262	56116.....	168, 169	59740-1.....	179	61172.....	142	67308.....	129
52693* ...	258, 262, 280	52805*.....	261	56507.....	123	59741.....	179	61174.....	142	67310.....	129
52694* ...	258, 262, 280	52806*.....	261	56680.....	94, 100	59741-1.....	179	61175.....	142	67311.....	129, 130
52695*.....	260	52807*.....	262	56728.....	144	59742.....	179	61177.....	142	67312.....	121, 123, 127, 128, 129, 130
52696*.....	259	52808*.....	277	57900.....	97, 123	59742-1.....	179	61180.....	142	67313.....	122, 129, 130
52699* ...	258, 262, 280	52810*.....	261, 262	57901.....	123	59743.....	179	61182.....	142	67315.....	122, 123, 129, 130
52702* ...	258, 262, 280	52811* ...	258, 262, 280	58000.....	144	59744.....	179	61230.....	136	67317.....	129, 130
52703* ...	258, 262, 280	52812* ...	258, 262, 280	58011.....	144, 146	59744-1.....	179	61250.....	136	67318.....	129, 130
52704* ...	258, 262, 280	52813* ...	258, 262, 280	58022.....	134	59745.....	182	61270.....	136	67320.....	129, 130
52706* ...	258, 262, 280	52815*.....	261	58030.....	174	59746.....	182	62155.....	142, 146	67327.....	121, 127, 128, 130
52707* ...	258, 262, 280	52816* ...	258, 262, 280	58033.....	144	59747.....	182	62157.....	142, 146	67409.....	120, 121, 122, 123, 127, 128, 129, 130
52708* ...	258, 262, 280	52817* ...	258, 262, 280	58044.....	144	59748.....	182	62165.....	142, 146	67411.....	129, 130
52709* ...	258, 262, 280	52818* ...	261, 262	58055.....	144	59749.....	182	62170.....	142, 146	67412.....	121, 123
52710* ...	258, 262, 280	52819*.....	261	58066.....	144	59750.....	182	62172.....	142, 146	67413.....	129, 130
52711* ...	258, 262, 280	52820*.....	261, 262	58110.....	157	59751.....	182	62175.....	142, 146	67414.....	122
52712* ...	258, 262, 280	52821*.....	261, 262	58123.....	157	59752.....	182	62177.....	142, 146	67417.....	129, 130
52713* ...	258, 262, 280	52822*.....	261, 262	58126.....	157	59753.....	181	62180.....	142, 146	67420.....	122
52714* ...	258, 262, 280	52827*.....	276	58130.....	174	59754.....	181	62182.....	142, 146	67421.....	120, 121, 122, 123, 127, 128, 129, 130
52715* ...	258, 262, 280	52828*.....	261	58160.....	174	59755.....	181	62300.....	225	67424.....	129, 130
52716* ...	258, 262, 280	52829*.....	261	58161.....	174	59756.....	181	62302.....	225	67426.....	122
52717* ...	258, 262, 280	52832* ...	258, 262, 280	58200.....	174	59757.....	181	62303.....	225	67427.....	121, 127, 128, 130
52718* ...	258, 262, 280	52834*.....	261	58322.....	144	59758.....	181	62304.....	225	67433.....	120, 122, 130
52719* ...	258, 262, 280	52844*.....	261	58333.....	144	59759.....	180	62305.....	225	67434.....	122
52720* ...	258, 262, 280	52845*.....	261	58344.....	144	59760.....	180	62306.....	225	67441.....	120, 121, 122, 123, 127, 128, 130
52721* ...	258, 262, 280	52846*.....	261	58355.....	144	59761.....	180	62308.....	225	67461.....	120, 121, 122, 130
52722* ...	258, 262, 280	52847*.....	261	58366.....	144	59762.....	180	62309.....	225	67481.....	120
52723* ...	258, 262, 280	52848*.....	261	58410.....	144	59763.....	180	62310.....	225	67491.....	120
52724* ...	258, 262, 280	52849* ...	258, 262, 280	58430.....	144	59764.....	182	62311.....	225	67508.....	122
52725* ...	258, 262, 280	52860.....	247	58440.....	144	59765.....	182	62312.....	225	67509.....	120, 121, 122, 123, 124, 127, 128, 130
52726* ...	258, 262, 280	52861.....	247	58450.....	144	59766.....	182	62313.....	225	67510.....	122, 124
52727* ...	258, 262, 280	52866.....	247	58460.....	144	59767.....	182	62315.....	225	67512.....	122, 124
52728* ...	258, 262, 280	52867.....	247	58480.....	144	59768.....	180	62318.....	225	67516.....	122, 124
52729* ...	258, 262, 280	52869.....	247	58500.....	144	59769.....	180	62319.....	225	67520.....	122, 124
52730* ...	258, 262, 280	52870.....	247	58510.....	144	59770.....	180	62320.....	225	67521.....	120, 121, 122, 123, 124, 125, 127, 128, 130
52731* ...	258, 262, 280	52908.....	145, 246	58520.....	144	59771.....	180	62321.....	225	67524.....	122
52732* ...	258, 262, 280	52930.....	230	58540.....	144	59771-1.....	180	62322.....	225	67532.....	122
52733* ...	258, 262, 280	52970.....	98	58600.....	144	59772.....	180	62323.....	225	67533.....	120, 122, 123, 130
52734* ...	258, 262, 280	54422.....	227	58620.....	144	59772-1.....	180	62325.....	225	67540.....	122
52735* ...	258, 262, 280			58700.....	145	59773.....	180	62327.....	225	67541.....	120, 121, 122, 123, 125, 127, 128, 130
52736* ...	258, 262, 280			58814.....	31	59773-1.....	180	62328.....	225	67560.....	122, 124
52737* ...	258, 262, 280	55010.....	12	58821A.....	299	59774.....	180	62331.....	225	67561.....	120, 121, 122, 130
52738* ...	258, 262, 280	55025.....	12	58821D.....	299	59774-1.....	180	62340.....	225	67580.....	122
52739* ...	258, 262, 280	55028.....	12	58822A-A.....	299	59775.....	180	62342.....	225	67581.....	120, 121, 122, 130
52740* ...	258, 262, 280	55457.....	12	58822-D-D.....	299	59776.....	180	64130.....	149	67607.....	127
52754* ...	258, 262, 280	55458.....	12	58823-A-A-A.....	299	59777.....	180			67608.....	127
52755* ...	258, 262, 280	55459.....	12	58823-D-D-D.....	299	59778.....	180				
52757* ...	258, 262, 280	55460.....	12	58824-A-A-A-A.....	299	59779.....	180				
52760* ...	258, 262, 280	55461.....	12	58824-D-D-D-D.....	299	59780.....	181				
52761* ...	258, 262, 280	55462.....	12	58832.....	299	59781.....	181				
52762* ...	258, 262, 280	55463.....	12	58833.....	299	59782.....	181				
52763* ...	258, 262, 280	55464.....	12	58834.....	299	59783.....	181				
52764* ...	258, 262, 280	55465.....	12	58842.....	299	59784.....	181				
52765* ...	258, 262, 280	55466.....	12	58843.....	299	59785.....	181				
52766* ...	258, 262, 280	55467.....	12	58900.....	118	59786.....	181				
				58910.....	118	59787.....	181				

60170

55010

*Not a complete item number – refer to page noted

ITEM	PAGE	ITEM	PAGE	ITEM	PAGE	ITEM	PAGE	ITEM	PAGE	ITEM	PAGE
67610	127	68298	164	69308	129	72175	60	77530	109	79450	163
67612	127	68301	129	69310	129	72176	60	77540	198	79540	161
67614	127	68302	129	69325	108	72180	60	77541	198	79800	163
67627	127	68303	129	69327	108	72181	60	77560	117	79818	163
67628	127	68304	129	69328	108	72196	58, 60	77572	117		
67630	127	68305	129	69329	108	72221	58, 59, 75	77580	117		
67632	127	68307	129	69402	121	72222	75	77600	117		
67634	127	68308	129	69404	121	72227	101	77610	117	80130	219
67691	120, 121, 130	68310	129	69406	121	72228	74, 101	77620	117	80150	219
67708	124	68350	164	69408	121	72231	74	77630	117	80170	219
67711	124	68351	162	69410	107, 108, 118	72240	173	77640	117	80190	219
67717	124	68352	162	69412	107, 108, 109	72241	64	77662	117	81020	234
67733	123	68357	136	69414	107, 108, 109	72242	64, 198	77682	117	81170	238
67735	123	68358	136	69442	121	72425	57, 62	77702	117	81180	238
67737	123	68360	132	69444	121	72430	62	77739	108	81190	238
67807	127	68361	132	69446	121	72459	60	77740	108	82005	223
67808	127	68362	132	69448	121	72462	60	77741	108	82006	223
67810	127	68363	132	69504	32, 33	72500	64	77742	108	82020	234
67812	127	68364	132	69504F	33	72522	58	77743	108	82030	234
67814	127	68365	132	69505	32	72542	60	77744	108	82040	234
67927	127	68366	132	69507	32	72550	61	77745	108	82060	217
67928	127	68367	132	69508	32	72553	63	77746	108	82061	217
67930	127	68369	136	69520	32	72557	63	77747	108	82062	217
67932	127	68390	132	69521	32	72620	63	77750	109, 131	82090	217
67934	127	68391	132	69522	32	72630	61	77754	109, 131	82091	217
67947	127	68392	132	69523	32	72788	61	77760	108, 109	82092	217
67948	127	68408	120	69524	32	72789	57, 62	77761	108, 109	82093	217
67950	127	68413	120	69584	31	74100	89	77780	108	82094	217
67952	127	68414	120	69607	107, 108	74200	89	77790	108	82095	217
67954	127	68420	120	69608	107, 108	74262	95	77791	108	82096	217
		68426	120	69610	107, 108	74264	95	77792	108	82097	217
		68434	120	69612	107, 108	74300	89	78150	99	82098	217
		68444	120	69614	107, 108	75012	61, 94, 100	78154	99	82100	218
		68460	120	69807	107, 108	75013	83, 94, 100	78160	99	82101	218
68010	98	68520	249	69808	107, 108	75015	83, 94, 100	78164	99	82102	218
68020	11	68530	128	69810	107, 108	75020	94, 100	78174	99	82111	218
68020-0	242	68616	120	69812	107, 108	75025	96	78180	99, 118	82120	218
68028	11	68620	120	69814	107, 108	75060	97	78184	58, 59, 61, 74, 75, 99, 101, 212	82121	218
68076	136	68624	120	70005	96	75062	97	78194	58, 99	82122	218
68078	136	68631	120	70009	98	75070	97	78194	58, 99	82123	218
68080	136	68633	120	70012	87	75071	97	78200	99, 118	82131	218
68084	135	68640	120	70022	87	75072	97	78204	58, 75, 99, 101	82144	237
68085	135	68641	120	70042	87	75080	97	78321	118	82146	237
68089	137	68660	120	70100	89	75180	86	78331	118	82166	217
68090	137	68661	120	70110	89	75110	85, 88	78341	118	82167	217
68099	137	68680	120	70200	89	75120	85, 88, 96	78351	118	82169	217
68100	133	68681	120	70212	89	75130	85, 88, 96	78371	118	82170	217
68120	131	68690	120	70222	87	75140	85, 88, 96	78421	118	82172	217
68121	131	68691	120	70242	87	75160	86, 88, 96	78431	118	82173	217
68122	135	68700	120	70300	89	75180	86	78441	18	82174	217
68123	135	68701	120	70322	87	75202	95	78451	118	82366	218
68125	135	68720	173	70342	87	75204	95	78471	118	82367	218
68126	135	68733	121	70362	87	75210	85, 88, 96	78471	118	82368	218
68127	124	68735	121	70400	90	75220	85, 88, 96	78560	117, 118	82370	218
68129	124	68737	121	70500	89	75230	85, 88, 96	78600	117	82371	218
68130	124	68743	121	70600	90	75240	85, 88, 96	78600	117	82372	218
68134	109	68745	121	71001	57, 63	75260	86, 88, 96	78610	117	82373	218
68174	234	68747	121	71500	64	75280	86	78620	117	82375	218
68181	169	68750	163			75280	86	78630	117	82380	218
68182	169	69006	163			75360	86, 88	78640	117	84740	172
68183	169	69014	163			75450	95	78672	117, 118	84750	172
68184	169	69030	163	72000	57, 63	75460	86, 88	78682	117	84760	172
68215	121	69040	163	72009	58	77020	117	78702	117	84770	172
68218	121	69050	163	72017	57, 58	77070	75, 118	78710	99, 101, 197	84780	172
68224	121	69080	163	72018	58	77072	99, 117, 118	78720	99	86100	250
68227	125	69107	107, 108	72018	58	77073	118	78725	99	86101	250
68228	125	69108	107, 108	72020	57, 61	77110	75, 118	78730	99	86103	250
68250	136	69108	107, 108	72021	57, 58	77112	99, 117, 118	78740	99	86104	250
68251	136	69110	107, 108	72023	57, 61	77113	118	78760	99	86105	250
68252	136	69112	107, 108	72028	57, 59	77130	118	78780	99	86106	250
68253	136	69114	107, 108	72029	59	77133	118	78820	99	86107	250
68257	136	69130	163	72040	59	77150	95	79001	163	86109	250
68269	124	69207	107, 108	72045	57, 59	77200	91, 196	79002	163	86110	250
68270	124	69208	107, 108	72050	57, 61, 101	77250	98, 210	79018	163	86111	250
68271	124	69210	107, 108	72051	57, 61, 101	77350	88, 96	79020	99	86113	250
68272	124	69212	107, 108	72055	61	77400	98	79040	99	86114	250
68273	124	69214	107, 108	72056	61	77430	98	79080	99	86115	250
68289	124	69260	246	72060	136	77450	95	79100	99	86116	250
68290	124	69301	129	72090	57, 62	77500	98	79120	99, 118	86117	250
68291	124	69302	129	72120	173	77519	108	79170	99	86118	250
68292	124	69303	129	72165	60	77520	108, 109	79220	99, 118	86119	250
68293	124	69304	129	72166	60	77521	108, 109	79300	163	86120	250
68296	162	69305	129	72170	60	77522	108, 109	79301	163	86121	250
68297	162	69307	129	72171	60	77523	108	79302	163	86123	250

80130

68010

72000

*Not a complete item number – refer to page noted

ITEM.....	PAGE	ITEM.....	PAGE	ITEM.....	PAGE	ITEM.....	PAGE	ITEM.....	PAGE	ITEM.....	PAGE
86124.....	250	90442.....	90	97280.....	293	3102015.....	83	4781610.....	151	4981210.....	143
86125.....	250	90452.....	90	97285.....	275	3102020.....	83	4781612.....	152	4981220.....	143
86126.....	250	90462.....	90	97286.....	293	3102040.....	83	4781620.....	151	4981510.....	143
86127.....	250	90482.....	90	97290.....	293	3102120.....	83	4781622.....	152	4981520.....	143
86128.....	250	90502.....	89	97299.....	248	3102220.....	83	4781630.....	151	4982410.....	143
86129.....	250	90512.....	89	97300.....	276	3102240.....	83	4781640.....	151	4982420.....	143
86280.....	247	90522.....	89	97320.....	290	3103040.....	83	4781650.....	151	4987210.....	143
86282.....	247	90527.....	91	97326.....	290	4087924.....	43	4781660.....	151	4987220.....	143
86326.....	248	90542.....	89	99262.....	246	4087936.....	43	4781670.....	151	4987510.....	143
86328.....	248	90547.....	91	99615.....	246	4087948.....	43	4781680.....	151	4987520.....	143
86330.....	248	90552.....	89	99636.....	246	4450613.....	65	4790910.....	151		
86331.....	248	90562.....	89	99637.....	246	4600915.....	224	4790920.....	151	5200000	
86333.....	248	90622.....	90	99700.....	276	4600950.....	224	4790930.....	151		
86334.....	248	90642.....	90	99710.....	277	4600960.....	224	4790940.....	151	5200000.....	159
86336.....	248	90647.....	91	99740.....	211	4625910.....	120	4790950.....	151	5200011.....	159
86338.....	248	90662.....	90	99745.....	210, 211	4634010.....	201, 202, 212	4790960.....	151	5200030.....	159
86339.....	248	90682.....	90	99850.....	210, 212	4634020-1.....	202	4790970.....	151	5200040.....	159
86341.....	248	90922.....	90	99860.....	210, 212	4634110.....	201, 202	4790980.....	151	5200050.....	159
86350.....	248	90942.....	90	99869.....	210	4635110.....	201, 202	4791210.....	151	5200060.....	159
86351.....	248	91954.....	304	99870.....	210, 212	4635210.....	201, 202	4791220.....	151	5200070.....	159
86352.....	248	92020.....	234	99873.....	210	4635310.....	201, 202	4791230.....	151	5200080.....	159
86353.....	248	92110.....	162, 228	99880.....	212	4635410.....	201, 202	4791240.....	151	5200200.....	159
86360.....	248	92241.....	282			4635430-1.....	202	4791250.....	151	5200211.....	159
86361.....	248	92320.....	172	351032		4635510.....	201, 202	4791260.....	151	5200230.....	159
88184.....	56	93100.....	83, 89			4635610.....	201, 202	4791270.....	151	5200240.....	159
88184NS.....	56	93110.....	89	351032.....	38	4635710.....	201, 202	4791280.....	151	5200250.....	159
88204.....	56	93200.....	83, 89	351034.....	38	4635720-1.....	202	4791610.....	151	5200260.....	159
88204NS.....	56	93300.....	83, 89	351035.....	41	4635730-1.....	202	4791620.....	151	5200270.....	159
		93400.....	90	351036.....	39	4635810.....	201, 202	4791630.....	151	5200300.....	159
90002		93500.....	85, 88, 89	351037.....	39	4644010.....	199	4791640.....	151	5200311.....	159
90002.....	89	93600.....	90	351038.....	40	4644015.....	199	4791650.....	151	5200330.....	159
90012.....	89	93900.....	90	351042.....	40	4644020.....	199	4791660.....	151	5200340.....	159
90013.....	90	94100.....	83, 89			4644025.....	199	4791670.....	151	5200350.....	159
90017.....	91	94200.....	83, 89	400780		4644050.....	199	4791680.....	151	5200360.....	159
90022.....	89	94300.....	83, 89			4644055.....	199	4808715.....	155	5200370.....	159
90023.....	90	94400.....	90	400780.....	127	4644070.....	199	4808720.....	155	5270142.....	165
90027.....	91	94500.....	85, 88, 89	400880.....	127	4644080.....	199	4808780.....	155	5270182.....	165
90042.....	89	94600.....	90	401080.....	127	4652910.....	204	4808815.....	155	5270202.....	165
90043.....	90	94900.....	90	401080.....	127	4667470.....	194	4808820.....	155	5283520.....	142
90047.....	91	95100.....	91	401280.....	127	4667475.....	194	4808880.....	155	5283620.....	142
90052.....	89	95160.....	162	401480.....	127	4667480.....	194	4808915.....	155	5283720.....	142
90053.....	90	95200.....	91	407292.....	45	4667570.....	194	4808920.....	155	5283820.....	142
90062.....	89	95300.....	91	407302.....	45	4667575.....	194	4970110.....	143	5283920.....	142
90063.....	90	95320.....	162	407312.....	45	4667580.....	194	4970120.....	143	5284020.....	142
90082.....	89	95600.....	91	407372.....	45	4667670.....	194	4970210.....	143	5284120.....	155
90102.....	89	95640.....	162	407382.....	45	4667675.....	194	4970220.....	143	5284220.....	150
90112.....	89	97004.....	293	430712.....	122	4667680.....	194	4970310.....	143	5284320.....	150
90122.....	89	97005.....	293	434112.....	129	4689760.....	150	4970320.....	143	5292620.....	142
90142.....	89	97006.....	293	434212.....	129	4689815.....	150	4970410.....	143	5292720.....	142
90162.....	89	97007.....	293	434312.....	129	4689830.....	150	4970420.....	143	5292815.....	142
90182.....	89	97101.....	291	434412.....	129	4689840.....	150	4970510.....	143	5292820.....	142
90202.....	89	97102.....	291	434512.....	129	4689850.....	150	4970520.....	143	5292915.....	142
90212.....	89	97105.....	290	434812.....	129	4689860.....	150	4970610.....	143	5292920.....	142
90213.....	90	97106.....	290	448212.....	132	4689960.....	150	4970620.....	143	5293320.....	142
90217.....	91	97111.....	291	448312.....	132	4780610.....	151	4971510.....	143	5293420.....	142
90222.....	89	97112.....	291	465312.....	234	4780620.....	151	4971520.....	143	5950275.....	53
90223.....	90	97120.....	290	693208.....	107	4780630.....	151	4980010.....	143	5950280.....	53
90227.....	91	97121.....	290	693210.....	107	4780640.....	151	4980020.....	143	5950875.....	53
90242.....	89	97125.....	290	693212.....	107	4780650.....	151	4980110.....	143	5950880.....	53
90243.....	90	97126.....	290	693308.....	107	4780660.....	151	4980120.....	143	6412120.....	141
90247.....	91	97140.....	290	693310.....	107	4780670.....	151	4980210.....	143	6412220.....	141
90252.....	89	97160.....	292	693312.....	107	4780910.....	151	4980220.....	143	6412230.....	141
90262.....	89	97161.....	292	935303.....	133	4780911.....	152	4980230.....	143	6412320.....	141
90263.....	90	97166.....	292	939001.....	133	4780912.....	152	4980280.....	143	6412335.....	141
90282.....	89	97167.....	292	939002.....	133	478091280.....	152	4980310.....	143	6412420.....	141
90302.....	89	97168.....	289			4780920.....	151	4980320.....	143	6412445.....	141
90312.....	89	97180.....	292	1560102	14	4780922.....	152	4980322.....	144	6412520.....	141
90313.....	89	97181.....	292	3100020.....	83, 100	4780930.....	151	4980335.....	143, 146	6412620.....	141
90313.....	90	97182.....	292	3100040.....	83	4780940.....	151	4980410.....	61, 74, 143	6412655.....	141
90322.....	89	97186.....	292	3100020.....	83, 100	4780950.....	151	4980420.....	59, 143	6412820.....	141
90323.....	90	97190.....	279, 286	3100240.....	83	4780960.....	151	4980422.....	144	6412865.....	141
90327.....	91	97191.....	279, 286	3100320.....	83	4780970.....	151	4980445.....	143, 146	6414015.....	149
90342.....	89	97200.....	289	3100321.....	83	4780980.....	151	4980480.....	143, 146	6414030.....	149
90343.....	90	97201.....	289	3100322.....	83	4781210.....	151	4980510.....	143, 146	6414040.....	149
90347.....	91	97202.....	289	3100321.....	83	4781212.....	152	4980520.....	143, 146	6414050.....	149
90352.....	89	97203.....	289	3100340.....	83	4781220.....	151	4980610.....	143, 146	6414070.....	149
90362.....	89	97205.....	289	3100341.....	83	4781222.....	152	4980620.....	143, 146	6414080.....	149
90363.....	90	97206.....	289	3101015.....	83	4781230.....	151	4980622.....	144	6414215.....	149
90367.....	91	97207.....	289	3101020.....	83	4781240.....	151	4980655.....	143, 146	6414230.....	149
90382.....	89	97208.....	289	3101040.....	83	4781250.....	151	4980810.....	143, 146	6414240.....	149
90402.....	90	97211.....	289	3101120.....	83	4781260.....	151	4980820.....	143, 146	6414250.....	149
90412.....	90	97240.....	277	3101220.....	83	4781270.....	151	4980822.....	144	6414270.....	149
90422.....	90	97241.....	277	3101240.....	83	4781280.....	151	4980865.....	143, 146	6414280.....	149

*Not a complete item number – refer to page noted

ITEM PAGE	ITEM PAGE	ITEM PAGE	ITEM PAGE	ITEM PAGE	ITEM PAGE	ITEM PAGE
6422120 141		8240120 193	8244022 193	9094420 92		
6422220 141	8002410	8240210 193	8244024 193	9728810 293	C	
6422230 141		8240214 193	8244114 193	9728820 293		
6422320 141	8002410 93	8240216 193	8244118 193			CILLDS* 297
6422335 141	8002420 93	8240220 193	8244120 193			C1VW* 298
6422420 141	8004410 93	8240310 193	8244122 193			C2VLCILDS 281
6422445 141	8004420 93	8240314 193	8244124 193			CADJ-1 298
6422520 141	8006410 93	8240316 193	8244214 193			CADJ-2 298
6422620 141	8006420 93	8240320 193	8244218 193	72672019 65	72672019 65	CADJ-3 298
6422655 141	8008410 93	8240322 197	8244220 193	72675019 65	72675019 65	CADJ-4 298
6422820 141	8022410 93	8240410 193	8244222 193	72678019 65	72678019 65	CBB116-37 67
6422865 141	8022420 93	8240414 193	8244224 193	72681019 65	72681019 65	CBD117-37 67
6432120 141	8024410 93	8240416 193	8244314 193	72684019 65	72684019 65	CBD127-37 67
6432220 141	8024420 93	8240420 193	8244318 193	72687019 65	72687019 65	CBE117-37 67
6432230 141	8026410 93	8240510 193	8244320 193	72693019 65	72693019 65	CBE127-37 67
6432320 141	8026420 93	8240514 193	8244322 193	72705017 65	72705017 65	CBL2024 45
6432335 141	8028410 93	8240516 193	8244324 193	72705019 65	72705019 65	CBL2036 45
6432420 141	8032410 93	8240520 193	8250114 196	72711017 65	72711017 65	CBL2048 45
6432445 141	8032420 93	8240610 193	8250116 196	72711019 65	72711019 65	CBL2060 45
6432480 141	8034410 93	8240614 193	8250214 196	72717017 65	72717017 65	CBL2072 45
6432520 141	8034420 93	8240616 193	8250216 196	72717019 65	72717019 65	CBL90122 45
6432620 141	8036410 93	8240620 193	8250314 196	72723017 65	72723017 65	CBL90162 45
6432655 141	8036420 93	8240710 193	8250414 196	72723019 65	72723019 65	CBL90242 45
6432820 141	8042410 93	8240714 193	8250416 196	72729017 65	72729017 65	CBL90362 45
6432865 141	8042420 93	8240716 193	8250514 196	72729019 65	72729019 65	CBL90482 45
6433120 141	8044410 93	8240720 193	8250516 196	74110110 56, 58	74110110 56, 58	CBL90602 45
6433220 141	8044420 93	8241310 193	8250614 192	74110140 56	74110140 56	CBLD 316
6433230 141	8046410 93	8241314 193	8250616 192	720200002 74	720200002 74	CBMD 316
6433320 141	8046420 93	8241316 193	8250714 192	720200003 74	720200003 74	CFIFO-2X 302
6433335 141	8052410 93	8241320 193	8250716 192	720200102 74	720200102 74	CFIFO-4 302
6433420 141	8052420 93	8241410 193	8250814 192	720200103 74	720200103 74	CGA8008 42
6433445 141	8054410 93	8241414 193	8250816 192	720201002 74	720201002 74	CGA8016 42
6433480 141	8054420 93	8241416 193	8261710 194	720201003 74	720201003 74	CM2-12020 41
6433520 141	8062410 93	8241420 193	8261720 194	720201102 74	720201102 74	CM2-12026 41
6433580 141	8062420 93	8241910 197	8262205 195	720201103 74	720201103 74	CM4-20835 41
6433620 141	8064410 93	8241914 197	8262220 195	720202003 74	720202003 74	CM4-20835PA 41
6433655 141	8064420 93	8241916 197	8264205 195	720202005 74	720202005 74	CM4-24035 41
6433820 141	8066410 93	8241920 197	8264220 195	720202102 74	720202102 74	CM4-24035PA 41
6433865 141	8066420 93	8242010 191	8266205 195	720202103 74	720202103 74	COA7002 42
6950020 31	8092410 93	8242014 191	8266220 195			COA8004 42
6950502 32	8092420 93	8242016 191		595087502	595087502 53	COA8005 42
6950503 32	8094410 93	8242020 191			595087503 53	CP8-06 231
6950505 32	8094420 93	8242110 191	9002410		9002410 92	CR1 270
6951020 31	8203510 194	8242114 191	9002420 92		9002420 92	CR10 268
6952105 32	8220010 197	8242116 191	9004410 92		9004410 92	CR10F 268
6954301 32	8220014 197	8242120 191	9004420 92		9004420 92	CR10FFF 268
6954302 32	8230010 194, 197	8242214 191	9006410 92		9006410 92	CR10FFFF 268
6954302F 33	8230110 194, 196, 197	8242216 191	9008410 92		9008410 92	CR11 268
6954303 32	8230210 194, 196, 197	8242310 191	9022410 92		9022410 92	CR11G 268
6954303F 33	8230305 195	8242314 191	9024410 92		9024410 92	CR11GG 268
6954304 32	8230310 195	8242316 191	9024420 92		9024420 92	CR11GGG 268
6954305 32	8230405 195	8242320 191	9026410 92		9026410 92	CR11GGGG 268
6954704 32	8230410 195	8242324 191	9028410 92		9028410 92	CR11GGGGG 268
6958301 31	8230510 194, 196, 197	8242414 191	9032410 92		9032410 92	CR12 268
	8230510 194, 196, 197	8242416 191	9032420 92		9032420 92	CR12H 268
	8230620 194, 196, 197	8242514 191	9034410 92		9034410 92	CR12HH 268
	8230705 195	8242516 191	9034420 92		9034420 92	CR12HHH 268
	8230720 195	8242610 192	9036410 92		9036410 92	CR12HHHH 268
	8230805 195	8242614 192	9038410 92		9038410 92	CR13CCCC 268
	8230820 195	8242616 192	9042410 92		9042410 92	CR18 268
	8230905 195	8242620 192	9042420 92		9042420 92	CR18J 268
	8230920 195	8242710 192	9044410 92		9044410 92	CR18JJ 268
	8231005 195	8242714 192	9044420 92		9044420 92	CR18JJJ 268
	8231020 195	8242716 192	9046410 92		9046410 92	CR18JJJJ 268
	8231105 195	8242720 192	9046420 92		9046420 92	CR19AA 270
	8231120 195	8242810 192	9052410 92		9052410 92	CR19AAA 270
	8231220 194, 197	8242814 192	9052420 92		9052420 92	CR2 269
	8231320 194, 196, 197	8242816 192	9054410 92		9054410 92	CR2A 213, 269
	8231420 194, 196, 197	8242820 192	9054420 92		9054420 92	CR2AA 213, 269
	8231520 195, 196, 197	8242914 178	9062410 92		9062410 92	CR2AAA 213, 269
	8231610 194	8242916 192	9064410 92		9064410 92	CR2AAAA 213, 269
	8231620 194	8243014 192	9064420 92		9064420 92	CR2AAAAA 213, 269
	8231810 195	8243016 192	9066410 92		9066410 92	CR2AAAAA32 213
	8231820 195	8243114 192	9066420 92		9066420 92	CR2AAAAA32 213
	8240010 197	8243116 192	9092410 92		9092410 92	
	8240014 193, 197	8243210 178	9092420 92		9092420 92	
	8240016 197	8243214 192	9094410 92		9094410 92	
	8240018 193	8243216 192				
	8240020 193, 197	8243220 192				
	8240022 193, 197	8243314 192				
	8240024 193	8243316 192				
	8240110 193	8244014 193				
	8240114 193	8244018 193				
	8240116 193	8244020 193				

*Not a complete item number – refer to page noted

ITEM.....	PAGE	ITEM.....	PAGE	ITEM.....	PAGE	ITEM.....	PAGE	ITEM.....	PAGE	ITEM.....	PAGE
CR2AAAAAAA32.....	213	CTCL-3B.....	302	FMNL1.....	305	HPA1004.....	44	LSO2PS18B*.....	296	PLC-17.....	226
CR4.....	269	CTCL-4B.....	302	FMS-2A.....	305	HPA1006.....	44	LSO2PVB*.....	296	PM0912-6.....	273
CR4D.....	269	CTCPAN3-6.....	302	FMS-3.....	305	HRT1.....	274	LSCP-3P*.....	303	PM1211-3.....	273
CR4DD.....	269	CTCPAN9-9.....	302	FMS-4.....	305	HR1370*.....	277, 282	LSC4-4P*.....	303	PM1211-4.....	273
CR4DDD.....	269	CTFWH-6B.....	303	FMS-5.....	305	HRIA*.....	274			PM1211-5.....	273
CR4DDDD.....	269	CTFWH-8B.....	303	FMS-6.....	306	HRIA*.....	274	M		PM1211-6.....	273
CR5.....	269	CTL-2VS.....	303	FMS-7.....	306	HRIA*.....	274	MB-1.....	307	PM1412-6.....	273
CR5A.....	269	CTL3.....	301	FMT-1.....	305	HRIA*.....	274	MB98719.....	216	PM1510-4.....	273
CR5AA.....	269	CTL4.....	301	FTA1024.....	46	HRIA*.....	274	MB98720.....	216	PM1510-5.....	273
CR6.....	268	CTL5.....	301	FTA1036.....	46	HR1B1A*.....	274	MB98721.....	216	PM1912-6.....	273
CR6B.....	268	CTL-3VS.....	303	FTA7016.....	46	HR1B1B*.....	274	MB98722.....	216	PM2006-3.....	273
CR6BB.....	268	CTL-4VS.....	303	FTA8024.....	46	HR1B1BA*.....	274	MBA92819.....	216	PM2011-5.....	273
CR6BBB.....	268	CTNCLS-06.....	307	FTA8036.....	46	HR1B1BB*.....	274	MBA92820.....	216	PM2011-6.....	273
CR6BBB..	268	CTNFO-06.....	307	FTG2024.....	45	HR1B1BBA*.....	274	MBA92821.....	216	PM2110-4.....	273
CR6BBB..	268	CTNO-06.....	307	FTG2036.....	45	HR1B1BBB*.....	274	MBA92822.....	216	PM2110-5.....	273
CR7.....	268	CTS-2A.....	304	FTG2048.....	45	HR1C1*.....	274	MBC1014-3F-06.....	73	PM2209-3.....	273
CR7C.....	268	CVT4-120300.....	38	FTG2060.....	45	HR1C1A*.....	274	MBC1014-3R-06.....	73	PM2209-4.....	273
CR7CC.....	268	CVT4-208550.....	38	FTG2072.....	45	HR1C1C*.....	274	MCM-1.....	306	PM3008-4.....	273
CR7CCC.....	268	CVT4-208900.....	38	FTG9012.....	46	HR1C1CA*.....	274	MIN0012.....	19	PM3208-2.....	273
CR7CC..	268	CVT4-220DUAL.....	38	FTG9016.....	46	HR1C1CC*.....	274	MIN0022.....	19	PM3208-3.....	273
CR7CC..	268	CVT4-220550.....	38	FTG9024.....	46	HR1C1CCA*.....	274	MIX1007.....	21	PM3208-4.....	273
CR8.....	268	CVT4-220900.....	38	FTG9036.....	46	HR1C1CCC*.....	274	MIX1010.....	21	PM3807-2.....	273
CR8D.....	268	CVT4-220DUAL.....	38	FTG9048.....	46	HR1D1*.....	274	MIX1020.....	21	PM4407-3.....	273
CR8DD.....	268	CVT4-240550.....	38	FTG9060.....	46	HR1D1A*.....	274	MIX1030.....	21	PM4806-2.....	273
CR8DD..	268	CVT4-240900.....	38	FTT2024.....	46	HR1D1D*.....	274	MIX1040.....	21	POA8002.....	42
CR8DD..	268	CVT4-240DUAL.....	38	FTT2036.....	46	HR1D1DA*.....	274	MIX1060.....	21	PO4-20814L-R.....	39
CR9.....	268	D		FTT2048.....	46	HR1D1DD*.....	274	MLM-1.....	306	PO4-20814R-L.....	39
CR9E.....	268	DLH-1.....	304	FTT2060.....	46	HR1D1DDA*.....	274	MN-1.....	305	PO4-20818L-R.....	39
CR9EE.....	268	E		FTT2072.....	46	HR1D1DDD*.....	274	MR-1.5.....	306	PO4-20818R-L.....	39
CR9EEE.....	268	E4007.....	128	FWVH-3B.....	303	HR1F*.....	274	MR-2.....	306	PO4-22014R-L.....	39
CR9EEEE.....	268	E4008.....	128	FWVH-3X2B.....	303	HR1FA*.....	274	MRBM-1.....	306	PO4-22014R-L.....	39
CR9EEEE.....	268	E4010.....	128	G		HR1FF*.....	274	MRBM-2.....	306	PO4-22018L-R.....	39
CR9EEEE.....	268	E4012.....	128	G1L*.....	296	HR1FFA*.....	274	MRBM-3.....	306	PO4-22018R-L.....	39
CRA.....	287	E4014.....	128	G1LLDS*.....	297	HR1FFFA*.....	274	MS-2A.....	306	PO4-24014L-R.....	39
CRA-02.....	287	EBC-TB.....	72	G2H-LL*.....	296	HR2A*.....	274	MSG2003.....	21	PO4-24014R-L.....	39
CRA-06.....	287	ELBC-1.....	73	G2V-LL*.....	296	HR2D1*DDA... 277, 282		MSG3002.....	21	PO4-24018L-R.....	39
CRA-08.....	287	ELBC-2.....	73	G2V-LC*.....	296	HRA*.....	288	MSG3005.....	21	PO6-20818.....	39
CRA-19.....	287	EMBC-1.....	73	G2V-LL*.....	296	HRB*.....	288	MT-1.....	306	PO6-22018.....	39
CRA-21.....	287	EMBC-2.....	73	G2VLCDS*.....	297	HRB1*.....	288	MT-1.5.....	306	PO6-24018.....	39
CRA-44.....	287	ES4007.....	128	G3H-LL*.....	296	HRC*.....	288	MT-2.....	306		
CRB.....	287	ES4008.....	128	G3V-LCC*.....	296	HRC1*.....	288	MW-1.....	306		
CRB.....	287	ES4010.....	128	G3V-LC*S.....	296	HRD*.....	288	MWA7025.....	47		
CRB.....	287	ES4012.....	128	G3V-LL*.....	296	HRD1*.....	288	MWA7125.....	47		
CRB.....	287	ES4014.....	128	G4V-4L*.....	296	HRF*.....	288			R	
CRB.....	287	ESB-1.....	73	G4V-LL*CC.....	296					RDE7136.....	69
CRB.....	287	ESB-2.....	73	G4X-4L*.....	296					RDE7148.....	69
CRB.....	287	ESB3.....	73	G58801*.....	296					RDE7160.....	69
CRB.....	287	EZ4007.....	128	G58804*.....	296	I				RDE8136.....	68
CRB.....	287	EZ4008.....	128	G58806.....	298	ICE140-06.....	228	N-0001B.....	97	RDE8148.....	68
CRB.....	287	EZ4010.....	128	G58807.....	298	IDEP-3.....	317	N-0001G.....	97	RDE8160.....	68
CRB.....	287	EZ4012.....	128	G58821*.....	300	INC-80.....	298	N-0002B.....	97	RDE8236.....	68
CRB.....	287	EZ4014.....	128	G58822-AB-A.....	300	INC-80S18.....	298	N-0002G.....	97	RDE8248.....	68
CRB.....	287	FFA7020.....	48	G58823-AJ-D-D.....	300			N-0003B.....	97	RDE8260.....	68
CRB.....	287	FFA710.....	48	G58824-A-A-A-DP.....	300			N-0003G.....	97	RDE8336.....	69
CRB.....	287	FFA8020.....	48	G58836-AJ.....	300			N-0006B.....	97	RDE8348.....	69
CRB.....	287	FFA810.....	48	G58837-AM-AM.....	300	J		N-0006G.....	97		
CRB.....	287	FFA811.....	48	G58838-AJ-AM-AP.....	300	J1-L*.....	297	N3408.....	110, 112	N3408.....	110, 112
CRB.....	287	FFA813.....	48	G58842-CM-AM.....	300	J2H-LL*.....	297	N3409.....	110, 112	N3411.....	110, 112
CRB.....	287	FFA815.....	48	G58843-AP-CJ-CJ.....	300	J2V-LL*.....	297	N3412.....	110, 112	N3412.....	110, 112
CRB.....	287	FFA817.....	48	GS21-32.....	278, 283	J3V-LLL*.....	297	N3414.....	110, 112	N3414.....	110, 112
CRB.....	287	FMA7026.....	70					N3808.....	116	N3808.....	116
CRB.....	287	FMA7036.....	70	H				N3809.....	116	N3811.....	116
CRB.....	287	FMA7048.....	70	H1-L*.....	296	KDC1418-2-06.....	73	N3812.....	116	N3812.....	116
CRB.....	287	FMDL-2V.....	305	H2V-LC*.....	296	KDC1418-3-06.....	73	N3817.....	116	N3817.....	116
CRB.....	287	FMDL-3H.....	305	H2V-LL*.....	296	KDC1418-4F-06.....	73	N5300.....	134	N5300.....	134
CRB.....	287	FMDL-3V.....	305	H3V-LCC*.....	296	KDC1418-4R-06.....	73	N5834.....	137	N5834.....	137
CRB.....	287	FMF-2.....	306	H3V-LLL*.....	296			N5844.....	137	N5844.....	137
CRB.....	287	FMF-3.....	306	H4V-4L*.....	296			NBC11.....	71	NBC11.....	71
CRB.....	287	FMHVN-1.....	305	H4007.....	128, 296			NBCBB33F-06.....	71	NBCBB33F-06.....	71
CRB.....	287	FML-1.....	305	H4008.....	128	L					
CRB.....	287	FML-2.....	305	H4010.....	128	LBC.....	73	PLC-1.....	301	PLC-1.....	301
CRB.....	287	FML-2V.....	305	H4012.....	128	LBC1418-3F-06.....	73	PLC-2.....	301	PLC-2.....	301
CRB.....	287	FML-3.....	305	H4014.....	128	LBC1418-3R-06.....	73	PLC-3.....	301	PLC-3.....	301
CRB.....	287	FML-3V.....	305	H4015.....	131	LBL2012655.....	71	PLC-4.....	301	PLC-4.....	301
CRB.....	287	FML-4V.....	305	HDE8136.....	68	LD2-2.....	301	PLC-08.....	226	PLC-08.....	226
CRB.....	287	FMN-1.....	305	HDE8148.....	68	LD3-2.....	301	PLC-09.....	226	PLC-09.....	226
CRB.....	287	FMN-2.....	305	HDE8160.....	68	LDS-3.....	304	PLC-10.....	226	PLC-10.....	226
CRB.....	287	FMN-3.....	305	HDR5005.....	44	LDS-4CUP.....	302	PLC-11.....	226	PLC-11.....	226
CRB.....	287	FMN-4.....	305	HDR5007.....	44	LSO2IB*.....	296	PLC-12.....	226	PLC-12.....	226
CRB.....	287	FMN-5.....	305	HDR5009.....	44	LSO2IS18B*.....	296	PLC-15.....	226	PLC-15.....	226
CRB.....	287	FMN-6.....	305	HPA1002.....	44	LSO2IVB*.....	296	PLC-16.....	226	PLC-16.....	226
CRB.....	287	FMN-7.....	305			LSO2MS18B*.....	296				
CRB.....	287	FMN-8.....	305			LSO2MVS18B*.....	296				
CRB.....	287	FMN-9.....	305			LSO2PB*.....	296				

*Not a complete item number – refer to page noted

ITEM.....	PAGE	ITEM.....	PAGE	ITEM.....	PAGE	ITEM.....	PAGE	ITEM.....	PAGE	ITEM.....	PAGE
S12062.....	96	T4050HH.....	236	TR11A*.....	267	TR33*.....	213, 270, 286	V904890.....	183	WR-1000.....	242
S12064.....	96	T4080HH.....	236	TR11G*.....	267	TRA*.....	287	V904937.....	184	WR-1003.....	242
S12066.....	96	T4710HH.....	236	TR11GA*.....	267	TRB*.....	287	V904950.....	184	WR-1009.....	243
S20062.....	96	T7206.....	148	TR11GG*.....	267	TRC*.....	287	V904975.....	184	WR-1010.....	242
S20064.....	96	T720DW.....	78, 245	TR11GGA*.....	267	TRCV3*.....	286	V904980.....	184	WR-1017.....	242
S20066.....	96	TH-1.....	73	TR11GGG*.....	267	TRCV4*.....	286	V904990.....	184	WR-1020.....	242
SAC-2.....	284	TR1*.....	270	TR11GGGA*.....	267	TRD*.....	287	V927000.....	186	WR-1023.....	242
SAC-2A.....	284	TR1A*.....	270	TR11GGGG*.....	267	TRE*.....	287	V928000.....	186	WR-1024.....	243
SAC-4A.....	284	TR1AA*.....	270	TR11GGGGGA*.....	267	TRF*.....	287	V928001.....	186	WR-1025.....	243
SAC-4C.....	284	TR2*.....	269, 281	TR11GGGGG*.....	267	TRG*.....	287	V2220020.....	187	WR-1026-06.....	231
SAC-4D.....	284	TR2W*.....	282	TR12*.....	267	TRH*.....	287	V2220030.....	187	WR-1027-06.....	231
SAC-6.....	284	TR3*.....	271	TR12A*.....	267	TRICE16*.....	282	V2220040.....	187	WR-1028-06.....	231
SAC-SQ1.....	284	TR3AAP14*.....	271	TR12H*.....	267	TRICE25*.....	282	V2220050.....	187		
SAC-SQ1A.....	284	TR3AAP16.....	271	TR12HA*.....	267	TRICE36*.....	282	V2220070.....	187		
SAC-SQ4.....	284	TR4*.....	269	TR12HH*.....	267	TRJ*.....	287	V2220220.....	187		
SAC-SQ5.....	284	TR4A*.....	269	TR12HHA*.....	267	TRK*.....	287	V2220230.....	187	XLBC1F-1826-13.....	72
SAVC.....	284	TR4D*.....	269	TR12HHH*.....	267	TRM.....	287	V2220240.....	187	XLBC1FR-1826-13.....	72
SBB12.....	71	TR4DA*.....	269	TR12HHHA*.....	267	TRPEG.....	271	V2220250.....	187	XLBC2F-1826-13.....	72
SBB12F-06.....	71	TR4DD*.....	269	TR12HHHH*.....	267	TSA7009.....	47	V2220270.....	187	XLBC2FR-1826-13.....	72
SBB13.....	71	TR4DDA*.....	269	TR12HHHHA*.....	267	TSA7012.....	47	V2220320.....	187	XLBC2P-1826-13.....	72
SBB13F-06.....	71	TR4DDD*.....	269	TR12HHHHH*.....	267	TSA7109.....	47	V2220330.....	187	XLBC3F-1826-13.....	72
SBB23.....	71	TR4DDDA*.....	269	TR13.....	267	TSA7309.....	47	V2220340.....	187	XLBC3FR-1826-13.....	72
SBB23F-06.....	71	TR4DDDD*.....	269	TR13A*.....	267	TSI7001.....	47	V2220350.....	187	XLBC3P-1826-13.....	72
SBB2X2.....	71	TR5*.....	269	TR13AW*.....	267	TSI8002.....	47	V2220370.....	187	XLBC3R-1826-13.....	72
SBB2X2F-06.....	71	TR5A*.....	269	TR13B*.....	267	TT-2.....	305	V9047900.....	186	XMIX0702.....	21
SBB33.....	71	TR5AA*.....	269	TR13BB*.....	267			VAC1212.....	316	XMIX0703.....	21
SBB33F-06.....	71	TR6*.....	267	TR13BBB*.....	267			VCBA118-37.....	77	XMIX0704.....	21
SBC.....	73	TR6A*.....	267	TR13BBBB*.....	267			VCBA128-37.....	77	XMIX0705.....	21
SBC1014-2F-06.....	73	TR6B*.....	267	TR13CCCC*.....	267	V20072.....	186	VCBA168-37.....	77		
SBC1014-2R-06.....	73	TR6BA*.....	267	TR13CC*.....	267	V210201.....	95	VCBF118-37.....	77		
SBC11.....	71	TR6BB*.....	267	TR13CCC*.....	267	V210202.....	95	VCBF128-37.....	77		
SBC11F-06.....	71	TR6BBA*.....	267	TR13CCCC*.....	267	V210401.....	95	VCBF168-37.....	77	Z4007.....	127
SBC12.....	71	TR6BBB*.....	267	TR13D*.....	267	V210651.....	95	VCBL300.....	311, 315	Z4008.....	127
SBC12F-06.....	71	TR6BBBA*.....	267	TR13DD*.....	267	V211001.....	95	VCBL500.....	311, 315	Z4010.....	127
SC-1007-13.....	243	TR6BBBB*.....	267	TR13DDD*.....	267	185.....	185	VCBL5P00.....	311, 315	Z4012.....	127
SG-200.....	175	TR6BBBBB*.....	267	TR13DDDD*.....	267	V22171.....	186	VCBLSS.....	316	Z4014.....	127
SH-1.....	301	TR6BBBBBB*.....	267	TR13F*.....	267	V22172.....	186	VCBM300.....	311, 315	Z43412.....	129
SLC-1.....	301	TR7*.....	267	TR13FF*.....	267	V22173.....	186	VCBM500.....	311, 315	Z434212.....	129
SLC-2.....	301	TR7A*.....	267	TR13FFF*.....	267	V22200.....	187	VCBMSS.....	316	Z434312.....	129
SLC-3.....	301	TR7C*.....	267	TR13FFFF*.....	267	V22201.....	187	VCT4-208.....	38	Z434412.....	129
SLC-4.....	301	TR7CA*.....	267	TR13G*.....	267	V22202.....	187	VCT4-240.....	38		
SO2-12010.5.....	40	TR7CC*.....	267	TR13GG*.....	267	V22203.....	187	VDBACC.....	316		
SO2-20810.5.....	40	TR7CCA*.....	267	TR13GGG*.....	267	V22204.....	187	VDBBM300.....	311, 317		
SO2-20814.5.....	40	TR7CCC*.....	267	TR13GGGG*.....	267	V22211.....	187	VDBBM500.....	311, 317		
SO2-22010.5.....	40	TR7CCCA*.....	267	TR13H*.....	267	V210201.....	95	VDBBM5P00.....	311, 317		
SO2-22014.5.....	40	TR7CCCC*.....	267	TR13HH*.....	267	V210202.....	95	VDBCC.....	316		
SO2-24010.5.....	40	TR7CCCCA*.....	267	TR13HHH*.....	267	V210401.....	95	VDBM300.....	311, 314		
SO2-24014.5.....	40	TR7CCCCC*.....	267	TR13HHHH*.....	267	V210651.....	95	VDBM500.....	311, 314		
SO4-20814L-R.....	40	TR8*.....	267	TR13J*.....	267	V211001.....	95	VDBPACC.....	316		
SO4-20814R-L.....	40	TR8A*.....	267	TR13JJ*.....	267	V210401.....	95	VDBPB.....	316		
SO4-22014L-R.....	40	TR8D*.....	267	TR13JJJ*.....	267	V210651.....	95	VDBPCC.....	316		
SO4-22014R-L.....	40	TR8DA*.....	267	TR13JJJJ*.....	267	V211001.....	95	VDBPS.....	316		
SO4-24014L-R.....	40	TR8DD*.....	267	TR13K*.....	267	V903001.....	186	VDBW.....	316		
SO4-24014R-L.....	40	TR8DDA*.....	267	TR13KKK*.....	267	V903002.....	186	VEPP106.....	311, 317		
STA8002.....	44	TR8DDD*.....	267	TR13KKKK*.....	267	V904141.....	185	VL-3.....	304		
		TR8DDDA*.....	267	TR13M*.....	267	V904146.....	185	VL-4.....	304		
		TR8DDDD*.....	267	TR13MM*.....	267	V904200.....	185	VMCOMPI2.....	316		
		TR8DDDDA*.....	267	TR13MMM*.....	267	V904300.....	185, 186	VP1212.....	316		
		TR8DDDDD*.....	267	TR13MMMM*.....	267	V904333.....	188	VPB316.....	311, 314		
T		TR9*.....	267	TR14.....	271	V904444.....	188	VPB318.....	311, 314		
T1041P.....	169	TR9A*.....	267	TR15*.....	270	V904500.....	185, 316	VPB516.....	311, 314		
T1042P.....	169	TR9E*.....	267	TR16*.....	269	V904555.....	188	VPB518.....	311, 314		
T3500.....	210	TR9EA*.....	267	TR16B*.....	269	V904600.....	185	VPB5P18.....	311, 314		
T3505.....	210	TR9EE*.....	267	TR16BB*.....	269	V904610.....	184	VTB300.....	311, 316		
T3505FF.....	206, 201	TR9EEA*.....	267	TR16BBB*.....	269	V904612.....	184	VTB500.....	311, 316		
T3505WP.....	210	TR9EEE*.....	267	TR16BBBB*.....	269	V904650.....	184	VTB5P00.....	311, 316		
T3515DFP.....	210	TR9EEEA*.....	267	TR18*.....	267	V904652.....	184	VTBW300.....	311, 316		
T3600.....	211	TR9EEEA*.....	267	TR18A*.....	267	V904660.....	184	VTBW500.....	311, 316		
T3605.....	211	TR9EEEE*.....	267	TR18J*.....	267	V904680.....	184	VTBW5P00.....	311, 316		
T3605SM.....	135	TR9EEEEE*.....	267	TR18JA*.....	267	V904682.....	184				
T3610SM.....	135	TR10*.....	267	TR18JJ*.....	266, 267	V904720.....	184				
T3633.....	206, 211, 212	TR10A*.....	267	TR18JJA*.....	267	V904721.....	184				
T3660.....	206, 212	TR10F*.....	267	TR18JJJ*.....	267	V904725.....	184	WB-8006.....	241		
T4007.....	127	TR10FA*.....	267	TR18JJJA*.....	267	V904800.....	185	WB-8006-06.....	241		
T400780.....	127	TR10FF*.....	267	TR18JJJJ*.....	267	V904801.....	185	WB-8007.....	241		
T4008.....	127	TR10FFA*.....	267	TR21*.....	272	V904807.....	185	WB-8007-06.....	241		
T400880.....	127	TR10FFF*.....	267	TR22*.....	272	V904809.....	183	WC-6004.....	241		
T4010.....	127	TR10FFFA*.....	267	TR23*.....	272	V904810.....	183	WC-6004-06.....	241		
T4012.....	127	TR10FFFF*.....	267	TR30.....	272	V904820.....	183	WC-6007-06.....	241		
T401280.....	127	TR11*.....	267	TR31*.....	272	V904850.....	183	WC-6009.....	241		
T4014.....	127							WP9-06.....	241		
T401480.....	127										
T4030HH.....	236										

X

Z

*Not a complete item number – refer to page noted

Aluminum: Sheet Metal Gauges

INCHES	DEC.	MM	GAUGE*	INCHES	DEC.	MM	GAUGE*
1/64	.15625	—	—	7/64	.109375	2.778	—
	.0201	—	24		.1144	—	9
	.0226	—	23		.1181	3.000	—
	.0253	—	22	1/8	.1250	3.175	—
	.0285	—	21		.1285	—	8
1/32	.03125	.794	—		.137795	3.500	—
	.031496	.800	—	9/64	.140625	3.571	—
	.0320	—	20		.1443	—	7
	.0359	—	19	5/32	.15625	3.968	—
	.03937	1.000	—		.15748	4.000	6.25
	.0403	—	18		.1620	—	6
	.0453	—	17	11/64	.171875	4.365	—
3/64	.046875	1.190	—		.177165	4.500	—
	.0508	—	16		.1819	—	5
	.0571	—	15	3/16	.1875	4.762	—
1/16	.0625	1.587	—		.19685	5.000	—
	.063	—	—	13/64	.203125	5.159	—
	.0641	—	14		.2043	—	4
	.0720	—	13		.216535	5.500	—
5/64	.078125	1.984	—	7/32	.21875	5.556	—
	.07874	2.000	—		.2294	—	3
	.0808	—	12	15/64	.234375	5.953	—
	.0907	—	11		.23622	6.000	—
3/32	.09375	2.381	—	1/4	.250	6.350	—
	.098425	2.500	—		.2576	—	2
	.1019	—	10		.2893	—	1

*American or Brown & Sharpe Wire Gauges
(Machinery Handbook, 21st Ed., 1981, Pgs. 464 & 465)

S/S: Steel Sheet Gauges

INCHES	DEC.	MM	GAUGE*	INCHES	DEC.	MM	GAUGE*
1/64	.0149	—	28	5/64	.078125	1.984	—
	.015625	.396	—		.07874	2.0	—
	.015748	.4	—		.086614	2.2	—
	.0179	—	26		.0897	—	13
	.0209	—	25	3/32	.09375	2.381	—
	.023622	.6	—		.094488	2.4	—
	.0239	—	24		.098425	2.5	—
	.0269	—	23		.1046	—	12
	.027559	.7	—		.106299	2.7	—
	.0299	—	22	7/64	.109375	2.778	—
1/32	.03125	.794	—		.1181	3.0	—
	.031496	.8	—		.1196	—	11
	.0329	—	21	1/8	.125	3.175	—
	.035433	.9	—		.1345	—	10
	.0359	—	20		.1495	—	9
	.03937	1.0	—	5/32	.15625	3.968	—
	.0418	—	19		.15748	4.000	—
3/64	.046875	1.19	—		.1644	—	8
	.047244	1.2	—		.1793	—	7
	.0478	—	18	3/16	.1875	4.762	—
	.0538	—	17		.188976	4.8	—
	.059055	1.5	—		.192913	4.9	—
	.0598	—	16		.1943	—	6
1/16	.0625	1.567	—	13/64	.203125	5.159	—
	.0673	—	15		.2092	—	5
	.0747	—	14		.2242	—	4
					.23622	6.0	—
					.2391	—	3
				1/4	.250	6.35	—

Weights, Measures and Metric Equivalents

LINEAR MEASURE

1 mil	=	0.001 inch	=	0.0254 millimeter
1 inch	=	1,000 mils	=	2.54 centimeter
12 inches	=	1 foot	=	0.3048 meter
3 feet	=	1 yard	=	0.9144 meter

SQUARE MEASURE

		1 square inch	=	6.452 square centimeters
144 square inches	=	1 square foot	=	929.03 square centimeters
9 square feet	=	1 square yard	=	0.8361 square meters

CUBIC MEASURE

		1 cubic inch	=	16.387 cubic centimeters
1,728 cubic inches	=	1 cubic foot	=	0.0283 cubic meters
27 cubic feet	=	1 cubic yard	=	0.7646 cubic meters

CONVERSION FORMULAS

Inches	x	25.4	=	mm	mm	x	.03937	=	Inches
Inches	x	2.54	=	cm	cm	x	.3937	=	Inches
					Meters	x	3937	=	Inches
					Meters	x	3.2809	=	Feet

DRY MEASURE

1 pint		33.6 cubic inches	=	0.5506 liter
2 pints (1 quart)	=	67.2 cubic inches	=	1.1012 liters
8 quarts	=	537.61 cubic inches	=	8.8098 liters

LIQUID MEASURE

1 fluid ounce	=	1.805 cubic inches	=	29.57 ml
4 fluid ounces	=	7.219 cubic inches	=	0.1183 liter
1 pint	=	28.875 cubic inches	=	0.4732 liter
2 pints (1 quart)	=	57.75 cubic inches	=	0.9464 liter
4 quarts (1 gallon)	=	231 cubic inches	=	3.7854 liters

AVOIRDUPOIS WEIGHT

1 ounce	=	.0625 pound	=	28.3495 grams
16 ounces	=	1 pound	=	453.59 grams
100 pounds	=	1 hundredweight	=	45.36 kilograms

**Manufacturer's Standard Gauge for Sheet Steel
(Based on 41.82 lbs. per sq. foot per in. thick – Machinery Handbook, 21st Ed., 1981, Pgs. 464 & 465)

Vollrath Online

TOOLS TO HELP YOU

Vollrath offers convenient online access to a wealth of resources, including product information, recipes, user guides, new product email alerts, and more at VOLLRATH.com.



New Products Microsite



Stay up to date with our latest innovative, industry-leading products that bring creative proficiency to today's foodservice operations.

VOLLRATH.com/newproducts

Miramar[®] Templates Configurator



With a Miramar Template, your buffet can be the pinnacle of both organization and beauty. This new configurator helps you construct a personal buffet setup.

VOLLRATH.com/miramar

LidSaver[™] 2 Microsite



The LidSaver 2 eliminates the messy, unsanitary, and wasteful pile of lids that you often see at quick-serve operations. Visit our site to learn more about the benefits and the build-your-own LidSaver lineup.

VOLLRATH.com/LidSaver-2

Cubic Microsite



The modern, sleek design of our Cubic Display System offers limitless versatility with configuration options that allow you to create the ideal setup for every occasion. Learn more about how to put Cubic to work for you.

VOLLRATH.com/cubic

Warewashing Rack Guide

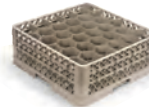

Take the guesswork out of finding a rack that fits your glasses or mugs with our new Warewashing Rack Guide.

VOLLRATH.com/warewashingconfigurator

A Toast, to Toast



From toast and bagels to pizza and toasted sandwiches, find out why the restaurant world has even more reason to celebrate.

VOLLRATH.com/toast

Warranty Policy

 TO VIEW OUR COMPLETE WARRANTY POLICY, PLEASE VISIT: VOLLRATH.com/warranty



Note: In the interest of continued product improvement, Vollrath reserves the right to change specifications without notice. Prices and availability also subject to change without notice.

Dimensions listed in catalog are approximate and may vary. Contact your Vollrath representative for specific drawing details.

Want more VOLLRATH?

LEARN MORE ABOUT HOW VOLLRATH CAN MAKE YOUR JOB EASIER AND HELP MAINTAIN THE QUALITY OF YOUR FOOD BY REQUESTING THESE PIECES AT VOLLRATH.COM/CATALOGS.



BRAND BOOK



SERVING SYSTEMS
& COMPONENTS

WE WANT YOUR FEEDBACK!

Visit VOLLRATH.com/survey to complete a short catalog survey.

SERVING SYSTEMS & COMPONENTS



DROP-IN COMPONENTS



BREATH GUARDS



HEAT & LIGHT STRIPS

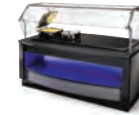

6-SERIES
– V-Class Custom



4-SERIES
– Signature Server®



2-SERIES
– Affordable Portable™



BACK-OF-HOUSE

Stay Connected & Informed

ASK A QUESTION, GET ASSISTANCE,
REQUEST SUPPORT, OR JUST SAY HELLO.

VOLLRATH.COM

CUSTOMER SERVICE: 800-628-0830

TECHNICAL SUPPORT: 800-628-0832

VISIT US ON:



Outperform every day.™

The Vollrath Company, L.L.C.
1236 North 18th Street
Sheboygan, WI 53081-3201

Main Tel: 920-457-4851
Fax: 800-752-5620 or
920-459-6573

Customer Service: 800-628-0830
Credit: 920-459-5387
Canada Customer Service: 800-695-8560
Technical Services: 800-628-0832

vollrath.com



©2019 The Vollrath Company, L.L.C. | An ISO 9001 Certified Company | Form No. 134567 (English) | Printed in USA